

Scheme Booklet registered by ASIC

Newcrest Mining Limited (ASX, TSX, PNGX: NCM) refers to the announcement made on 7 September 2023 in connection with:

- the proposed acquisition of Newcrest by Newmont Overseas Holdings Pty Ltd, a wholly owned indirect subsidiary of Newmont Corporation, by way of a scheme of arrangement (Scheme); and
- the orders made by the Federal Court of Australia that Newcrest convene a meeting of Newcrest shareholders to consider and vote on the Scheme (Scheme Meeting) and approving the distribution of an explanatory statement providing information about the Scheme and the Notice of Scheme Meeting (Scheme Booklet) to Newcrest shareholders.

Scheme Booklet and Independent Expert's report

Newcrest confirms that the Scheme Booklet has today been registered with the Australian Securities and Investments Commission (ASIC). A copy of the Scheme Booklet is attached and will also be made available on Newcrest's website (www.newcrest.com/investor-centre/schememeeting). For details of how you will receive the Scheme Booklet, please refer to Newcrest's announcement made on 7 September 2023.

The Scheme Booklet includes a copy of the Independent Expert's report prepared by Grant Samuel & Associates Pty Limited (Independent Expert). The Independent Expert has concluded that the Scheme is in the best interests of Newcrest shareholders in the absence of a superior proposal. The Independent Expert's conclusion should be read in context with the full Independent Expert's report, which can be found in Annexure 1 of the Scheme Booklet.

Recommendation of Newcrest Directors

The Newcrest Directors unanimously recommend that Newcrest shareholders vote in favour of the Scheme, in the absence of a superior proposal and subject to the Independent Expert continuing to conclude that the Scheme is in the best interests of Newcrest shareholders. Subject to those same conditions, each Newcrest Director will vote, or procure the voting of, any Newcrest shares held or controlled by them, or held on their behalf, at the time of the Scheme Meeting in favour of the Scheme.

Scheme Meeting

The Scheme Meeting will be held at 10.30am (Melbourne time) on Friday, 13 October 2023 in person at RACV City Club, 501 Bourke Street, Melbourne, Victoria 3000 and online at <https://meetings.linkgroup.com/NCMSHEME>.

All registered Newcrest shareholders as at 7.00pm (Melbourne time) on Wednesday, 11 October 2023 will be eligible to vote at the Scheme Meeting.

All Newcrest shareholders are encouraged to vote either by completing and returning the proxy form or alternatively by casting a direct vote or attending the Scheme Meeting in person, attending online or by proxy, attorney or corporate representative. The Scheme Booklet provides information on how to lodge your proxy form (if applicable).

Extension of time to hold AGM and dispatch Annual Report granted by ASIC

In view of the pending Scheme, ASIC has formally granted Newcrest:

- an extension of the period of time by which Newcrest must hold its annual general meeting for the financial year ended 30 June 2023 (AGM) from 30 November 2023 to 29 February 2024; and

- an extension of the period for dispatch of Newcrest's 2023 Annual Report until 21 days before the AGM or 31 January 2024, whichever is the earlier.

This follows ASIC's earlier in principle decision that it would grant these extensions, as noted in the Scheme Booklet.

Shareholder Information Line

If you have any questions in relation to the Scheme or the Scheme Booklet, please contact the Newcrest Shareholder Information Line on 1800 425 578 (within Australia) or +61 1800 425 578 (outside Australia), between 8.30am and 7.30pm (Melbourne time), Monday to Friday (excluding public holidays).

Authorised by the Newcrest Disclosure Committee

For further information please contact

Investor Enquires

Tom Dixon

+61 3 9522 5570

+61 450 541 389

Tom.Dixon@newcrest.com.au

Rebecca Lay

+61 3 9522 5298

+61 438 355 511

Rebecca.Lay@newcrest.com.au

North American Investor Enquiries

Vlada Cvijetinovic

+1 604 335 9202

+1 604 240 2998

Vlada.Cvijetinovic@newcrest.com.au

Media Enquiries

Celina Watt

+61 3 9522 4264

+61 436 677 220

Celina.Watt@newcrest.com.au

This information is available on our website at www.newcrest.com



NEWCREST
MINING LIMITED

Scheme Booklet

For a scheme of arrangement in relation to the proposed acquisition of Newcrest Mining Limited ACN 005 683 625 by Newmont Overseas Holdings Pty Ltd ACN 667 845 454, a wholly owned indirect Subsidiary of Newmont Corporation.

The Newcrest Directors unanimously recommend that you vote in favour of the Scheme, in the absence of a Superior Proposal and subject to the Independent Expert continuing to conclude that the Scheme is in the best interests of Newcrest Shareholders.



VOTE IN FAVOUR

The Independent Expert has concluded that the Scheme is in the best interests of Newcrest Shareholders, in the absence of a superior proposal.

This is an important document and requires your immediate attention.

You should read it entirely before deciding whether or not to vote in favour of the Scheme.

If you are in any doubt about how to deal with this document, you should contact your legal, financial, tax or other professional adviser immediately.

Financial Advisers

J.P.Morgan
GRESHAM

Legal Adviser



**HERBERT
SMITH
FREEHILLS**

Important notices

General

This Scheme Booklet is important and requires your immediate attention. You should read this Scheme Booklet in full before making any decision as to how to vote at the Scheme Meeting.

Defined terms and interpretation

Capitalised terms used in this Scheme Booklet are defined in section 12. If a word or phrase is defined, its other grammatical forms have a corresponding meaning. The documents reproduced in the attachments to this Scheme Booklet may have their own defined terms, which sometimes differ from those in section 12.

Nature of this Scheme Booklet

This Scheme Booklet includes the explanatory statement for the Scheme required by subsection 412(1) of the Corporations Act.

This Scheme Booklet does not constitute or contain an offer to Newcrest Shareholders, or a solicitation of an offer from Newcrest Shareholders, in any jurisdiction. This Scheme Booklet is not a disclosure document required by Chapter 6D of the Corporations Act. Subsection 708(17) of the Corporations Act provides that Chapter 6D of the Corporations Act does not apply in relation to arrangements under Part 5.1 of the Corporations Act approved at a meeting held as a result of an order under subsection 411(1) of the Corporations Act. Instead, Newcrest Shareholders asked to vote on an arrangement at such a meeting must be provided with an explanatory statement as referred to above.

ASIC, ASX, PNGX and TSX

A copy of this Scheme Booklet has been registered by ASIC for the purposes of subsection 412(6) of the Corporations Act. ASIC has been given the opportunity to comment on this Scheme Booklet in accordance with subsection 411(2) of the Corporations Act. Neither ASIC, nor any of its officers, takes any responsibility for the contents of this Scheme Booklet.

ASIC has been requested to provide a statement, in accordance with paragraph 411(17)(b) of the Corporations Act, that it has no objection to the Scheme. If ASIC provides that statement, it will be produced to the Court at the time of the Court hearings to approve the Scheme.

A copy of this Scheme Booklet has been provided to ASX and PNGX. Neither ASX, PNGX, nor any of their officers, takes any responsibility for the contents of this Scheme Booklet.

A copy of this Scheme Booklet has been filed with the TSX and on SEDAR with applicable Canadian securities regulatory authorities. The Scheme has not been approved or disapproved by the TSX or any Canadian securities regulatory authority, nor has the TSX or any Canadian securities regulatory authority passed on the fairness or merits of the Scheme or upon the accuracy or adequacy of the information in this Scheme Booklet and any representation to the contrary is unlawful. Neither the TSX nor any of its officers take any responsibility for the accuracy or completeness of this Scheme Booklet.

Important notice associated with Court order under subsection 411(1) of the Corporations Act

The fact that, under subsection 411(1) of the Corporations Act, the Court has ordered that a meeting be convened and has approved the explanatory statement required to accompany the Notice of Scheme Meeting does not mean that the Court:

- has formed any view as to the merits of the proposed Scheme or as to how Newcrest Shareholders should vote (on this matter Newcrest Shareholders must reach their own conclusion); or
- has prepared, or is responsible for the content of, the explanatory statement.

Notice of Scheme Meeting

The Notice of Scheme Meeting is included in Annexure 5.

Notice of Second Court Hearing

At the Second Court Hearing, the Court will consider whether to approve the Scheme following the vote at the Scheme Meeting. Any Newcrest Shareholder may appear at the Second Court Hearing, currently expected to be held at 10:15am (Melbourne time) on Tuesday, 17 October 2023 at 305 William Street, Melbourne VIC 3000. Any Newcrest Shareholder who wishes to oppose approval of the Scheme at the Second Court Hearing may do so by filing with the Court and serving on Newcrest a notice of appearance in the prescribed form together with any affidavit that the Newcrest Shareholder proposes to rely on.

No investment advice

This Scheme Booklet has been prepared without reference to the investment objectives, financial and tax situation or particular needs of any Newcrest Shareholder or any other person. The information and recommendations included in this Scheme Booklet do not constitute, and should not be taken as, financial product advice. The Newcrest Directors encourage you to seek independent financial and tax advice before making any investment decision and any decision as to whether or not to vote in favour of the Scheme. This Scheme Booklet should be read in its entirety before making a decision on whether or not to vote in favour of the Scheme. In particular, it is important that you consider the potential risks, as set out in section 8, and the views of the Independent Expert set out in the Independent Expert's Report included in Annexure 1. If you are in doubt as to the course you should follow, you should consult an independent and appropriately licensed and authorised professional adviser immediately.

Forward looking statements

Some of the statements in this Scheme Booklet (including in the Independent Expert's Report) may be in the nature of forward looking statements or forward looking information within the meaning of Canadian securities laws (collectively "forward looking statements"). Forward looking statements or statements of intent in relation to future events in this Scheme Booklet (including in the Independent Expert's Report) should not be taken to be forecasts or predictions that those events will occur. Forward looking statements generally may be identified by the use of forward looking words such as 'believe', 'aim', 'expect', 'anticipate', 'intending', 'foreseeing', 'likely', 'should', 'planned', 'may', 'estimate', 'potential', or other similar words. Similarly, statements that describe the objectives, plans, goals, intentions or expectations of Newcrest or Newmont are or may be forward looking statements. You should be aware that such statements are only opinions and are subject to known and unknown risks, inherent risks and uncertainties, assumptions and other factors that may impact Newcrest's, Newmont's or the Merged Group's actual results, performance or achievements expressed, projected or implied by these forward looking statements. Those risks and uncertainties include factors and risks specific to Newcrest or Newmont and / or the industries in which they operate, as well as general economic conditions, prevailing exchange rates and interest rates and conditions in financial markets. In addition, factors related to the Scheme that contribute to the uncertain nature of the forward looking statements include, but are not limited to: the expected timing to implement the Scheme, filings and approvals relating to the Scheme, satisfaction of conditions, including shareholder approvals, and the possibility that a Government Agency may prohibit, delay or refuse to grant approval of the Scheme.

Actual events or results may differ materially from the events or results expressed or implied in any forward looking statement and deviations are both normal and to be expected. None of Newcrest, Newmont, or their respective officers, directors, employees or advisers or any person named in this Scheme Booklet or any person involved in the preparation of this Scheme Booklet makes any representation or warranty (either express or implied) as to the accuracy or likelihood of fulfilment of any forward looking statement, or any events or results expressed or implied in any forward looking statement. Accordingly, you are cautioned not to place undue reliance on those statements.

Any forward looking statements in this Scheme Booklet reflect views held only at the date of this Scheme Booklet. Subject to any continuing obligations under the ASX Listing Rules, the NYSE Listing Rules, the PNGX Listing Rules, the Corporations Act, United States securities laws or Canadian securities laws, Newcrest and Newmont and their respective officers, directors, employees and advisers, disclaim any obligation or undertaking to distribute after the date of this Scheme Booklet any updates or revisions to any forward looking statements to reflect (a) any change in expectations in relation to such statements; or (b) any change in events, conditions or circumstances on which any such statement is based.

All subsequent written and oral forward looking statements attributable to Newcrest, Newmont, or any person acting on their respective behalf are qualified by this cautionary statement.



Responsibility statement

Newcrest has prepared, and is responsible for, the Newcrest Information. Neither Newmont nor any of its subsidiaries, directors, officers, employees or advisers assume any responsibility for the accuracy or completeness of such information.

Newmont has prepared, and is responsible for, the Newmont Information. Neither Newcrest nor any of its subsidiaries, directors, officers, employees or advisers assume any responsibility for the accuracy or completeness of such information.

Grant Samuel & Associates Pty Limited has prepared the Independent Expert's Report and takes responsibility for that report. AMC Consultants Pty Ltd has prepared the Independent Technical Expert's Report included in the Independent Expert's Report and takes responsibility for that report. The Independent Expert's Report (including the Independent Technical Expert's Report) is included in Annexure 1. None of Newcrest or Newmont or any of their respective subsidiaries, directors, officers, employees or advisers (other than Grant Samuel & Associates Pty Limited in respect of the Independent Expert's Report and AMC Consultants Pty Ltd in respect of the Independent Technical Expert's Report) assume any responsibility for the accuracy or completeness of the information in the Independent Expert's Report or the Independent Technical Expert's Report, except in the case of Newcrest in relation to the information which it has provided to Grant Samuel & Associates Pty Limited and AMC Consultants Pty Ltd.

Ernst & Young Strategy and Transactions Limited has prepared the Independent Limited Assurance Report and takes responsibility for that report. The Independent Limited Assurance Report is included in Annexure 2. None of Newcrest or Newmont or any of their respective subsidiaries, directors, officers, employees or advisers (other than Ernst & Young Strategy and Transactions Limited) assume any responsibility for the accuracy or completeness of the information contained in the Independent Limited Assurance Report.

No consenting person has withdrawn their consent to be named before the date of this Scheme Booklet.

Foreign jurisdictions

The release, publication or distribution of this Scheme Booklet in jurisdictions other than Australia may be restricted by law or regulation in such other jurisdictions and persons outside of Australia who come into possession of this Scheme Booklet should seek advice on and observe any such restrictions. Any failure to comply with such restrictions may constitute a violation of applicable laws or regulations.

This Scheme Booklet has been prepared in accordance with the laws of Australia and the information in this Scheme Booklet may not be the same as that which would have been disclosed if this Scheme Booklet had been prepared in accordance with the laws and regulations of a jurisdiction outside of Australia.

This Scheme Booklet and the Scheme do not in any way constitute an offer of securities in any place in which, or to any person to whom, it would not be lawful to make such an offer.

Newcrest Shareholders who are nominees, trustees or custodians are encouraged to seek independent advice as to how they should proceed.

Further information is set out in section 11.9.

Notice to United States investors

The Newmont Shares to be issued pursuant to the Scheme (which may be represented by Newmont CDIs or Newmont PDIs), have not been and will not be registered under the Securities Act or the securities laws of any state, district or other jurisdiction of the United States. The Newmont Shares to be issued under the Scheme (which may be represented by Newmont CDIs or Newmont PDIs) will be issued in reliance on the exemption from the registration requirements of the Securities Act provided by section 3(a)(10) thereof on the basis of the approval of the Court, which will consider, among other things, the fairness of the terms and conditions of the issuance and exchange of such securities to Newcrest Shareholders.

United States investors should refer to sections 11.8 and 11.9(p) for further information concerning transfer restrictions disclosures and other notices.

Financial amounts and effects of rounding

All financial amounts in this Scheme Booklet are expressed in United States currency unless otherwise stated. A number of figures, amounts, percentages, estimates, calculations of value and fractions in this Scheme Booklet are subject to the effect of rounding. Accordingly, any discrepancies between totals in tables or financial information, or in calculations, graphs or charts are due to rounding. All financial and operational information set out in this Scheme Booklet is current as at the date of this Scheme Booklet, unless otherwise stated.

Notice to PNG investors

PNGX does not take any responsibility for the contents of this Scheme Booklet.

The fact that PNGX may quote Newmont PDIs and admit them to the Official List of PNGX is not to be taken in any way as an indication of the merits of Newmont.

The Independent Expert has given, and has not withdrawn, their written consent to the Scheme Booklet being published with the Independent Expert's Report included as set out in Annexure 1.

Newmont will issue a supplementary document if Newmont becomes aware of any of the following between the issue of this Scheme Booklet and the date Newmont PDIs are quoted and admitted to the official list of PNGX:

- a material statement in the Newmont Information is misleading or deceptive;
- there is a material omission from the Newmont Information;
- there has been a material change affecting a matter included in the Newmont Information; or
- a material new circumstance affecting Newmont has arisen that would have been required to be included in this Scheme Booklet.

Charts and diagrams

Any diagrams, charts, graphs or tables in this Scheme Booklet are illustrative only and may not be drawn to scale. Unless stated otherwise, all data included in diagrams, charts, graphs and tables is based on information available as at the Last Practicable Date.

Timetable and dates

All times and dates referred to in this Scheme Booklet are times and dates in Melbourne, Australia, unless otherwise indicated. All times and dates relating to the implementation of the Scheme referred to in this Scheme Booklet may change and, among other things, are subject to all necessary approvals from Government Agencies.

External websites

Unless expressly stated otherwise, the content of the websites of Newcrest and Newmont do not form part of this Scheme Booklet and Newcrest Shareholders should not rely on any such content.

Privacy

Newcrest may collect personal information in the process of implementing the Scheme. The type of information that it may collect about you includes your name, contact details and information on your shareholding in Newcrest and the names of persons appointed by you to act as a proxy, attorney or corporate representative at the Scheme Meeting as relevant to you. The collection of some of this information is required or authorised by the Corporations Act. The primary purpose of the collection of personal information is to assist Newcrest to conduct the Scheme Meeting and implement the Scheme. Without this information, Newcrest may be hindered in its ability to issue this Scheme Booklet and implement the Scheme. Personal information of the type described above may be disclosed to the Newcrest Share Registry, third party service providers (including print and mail service providers and parties otherwise involved in the conduct of the Scheme Meeting), authorised securities brokers, professional advisers, related bodies corporate of Newcrest, Government Agencies, and also where disclosure is otherwise required or allowed by law. Newcrest Shareholders who are individuals and the other individuals in respect of whom personal information is collected as outlined above have certain rights to access the personal information collected in relation to them. If you would like to obtain details of the information about you held by the Newcrest Share Registry in connection with Newcrest Shares, please contact the Newcrest Share Registry. Newcrest Shareholders who appoint an individual as their proxy, attorney or corporate representative to vote at the Scheme Meeting should ensure that they inform them of the matters outlined above. Further information about how Newcrest collects, uses and discloses personal information is set out in Newcrest's Privacy Policy located at www.newcrest.com.

Date of Scheme Booklet

This Scheme Booklet is dated 7 September 2023.

Table of contents

Letter from the Chairman of the Newcrest Board	3
Letter from the CEO of Newmont	4
Key dates	5
Section 1 Key considerations relevant to your vote	6
Section 2 Frequently asked questions	12
Section 3 What should you do?	22
Section 4 Overview of the Scheme	24
Section 5 Profile of the Newcrest Group	29
Section 6 Profile of the Newmont Group	48
Section 7 Profile of the Merged Group	84
Section 8 Risks	110
Section 9 Tax implications	145
Section 10 Comparison of relevant Australian and United States laws	156
Section 11 Additional information	170
Section 12 Definitions	189
Annexure 1 Independent Expert's Report	201
Annexure 2 Independent Limited Assurance Report	723
Annexure 3 Scheme of Arrangement	733
Annexure 4 Deed Poll	757
Annexure 5 Notice of Scheme Meeting	767
Corporate directory	771

Dear Newcrest shareholder,

On behalf of the Newcrest Board, I am pleased to present you with details of a proposed transaction where Newcrest will be acquired by Newmont. If implemented, Newcrest and Newmont combined will create the world's largest diversified owner of Tier 1 gold assets with a growing exposure to copper.

On 15 May 2023, Newcrest announced it had entered into a Scheme Implementation Deed with Newmont under which, and subject to certain conditions including the approval of Newcrest shareholders, 100% of Newcrest shares will be acquired by Newmont through a scheme of arrangement.

This Scheme Booklet sets out details of the proposed transaction and important matters relevant to your vote in relation to the Scheme.

If the Scheme is approved, Newcrest shareholders will receive **0.400 Newmont shares for each Newcrest share held** and Newcrest expects to pay a **franked special dividend of US\$1.10 per Newcrest share**.

The Newmont shares will be issued as shares quoted on the New York Stock Exchange or as shares represented by CDIs or PDIs quoted on the ASX or PNGX.

The proposed transaction followed many months of negotiation between Newcrest and Newmont, during which the transaction terms were improved significantly by Newmont over three occasions.

Your Board considered the advantages and disadvantages of the transaction for Newcrest shareholders and received financial and legal advice. Your Board is confident the proposed terms for you to consider are the best available. To date, no alternative superior proposal has been received from another party to acquire or merge with Newcrest.

This Scheme Booklet outlines for your consideration the main advantages and disadvantages of the proposed transaction, the key conditions and approvals required, and you are encouraged to read it.

Your Board considers there are many benefits from the transaction for Newcrest shareholders, including:

- Newcrest shareholders will receive an attractive premium for their Newcrest shares.
- A merged Newmont and Newcrest will own a large diversified, high-quality portfolio of Tier 1 gold assets with a growing exposure to copper.
- As a Newmont shareholder, you will retain your exposure to Newcrest as part of the merged group and continue to participate in many of the benefits of being a Newcrest shareholder.
- Newcrest shareholders will own approximately 31% of Newmont if the transaction is implemented and share in synergies that Newmont expects from combining with Newcrest.

The transaction requires approval by Newcrest shareholders. A majority of Newcrest shareholders present and voting, and at least 75% of votes cast at the Scheme Meeting, must be in favour of the Scheme.

The Independent Expert, Grant Samuel, has concluded that the Scheme is in the best interests of Newcrest shareholders, in the absence of a superior proposal. A copy of the Grant Samuel report is included in Annexure 1.

The Newcrest Directors unanimously **recommend that you vote in favour of the Scheme**, in the absence of a superior proposal and subject to the Independent Expert continuing to conclude that the Scheme is in the best interests of Newcrest shareholders. Each Newcrest Director intends to vote their shares in favour of the Scheme, subject to the same conditions.

Your vote is important. I encourage you to vote by attending the Scheme Meeting in person or otherwise by following the voting instructions set out in this Scheme Booklet.

The Scheme Meeting is scheduled for 10.30am (Melbourne time) on Friday, 13 October 2023 in person at RACV City Club, 501 Bourke Street, Melbourne, Victoria 3000, and online at <https://meetings.linkgroup.com/NCMSHEME>.

If you have any questions, please contact the Newcrest Shareholder Information Line on 1800 425 578 (within Australia) or +61 1800 425 578 (outside Australia), between 8.30am and 7.30pm (Melbourne time), Monday to Friday (excluding public holidays).

On behalf of the Newcrest Directors, I would like to thank you for your support of Newcrest. We are proud of the entire Newcrest team for building a world class metals business, which will form a key part of the merged group.

We believe our shareholders can look forward to an exciting future as a Newmont shareholder.

Yours sincerely,



Peter Tomsett
Chairman

Newcrest Mining Limited

Dear Newcrest Shareholder,

On behalf of the Newmont Board of Directors and the Newmont management team, we are pleased to provide you with the opportunity to participate in the Scheme and to benefit from the continuing success of what will be a unique global mining company.

Newmont is the world's leading gold company and a producer of copper, silver, zinc and lead. We are widely recognised for our principled environmental, social and governance practices that have contributed to us being identified as the top gold miner in the Dow Jones Sustainability Index for the last eight years.¹ We have created an unmatched global portfolio of world-class operations and projects in top tier mining jurisdictions with both the scale and mine life to sustain our business for decades to come. These assets are managed through our integrated operating model and are led by a highly experienced management team with a focus on robust safety standards and a proven track record of delivering value.

We have closely followed Newcrest's success since it was separated from Newmont, and we are truly excited about the opportunity to generate significant additional value for all shareholders through the combination. There are four key pillars to our rationale for the Scheme, which will benefit shareholders of both companies:

- **The New Sustainability Standard:** Newmont will apply its proven leading sustainability practices to bring clear focus on mitigating safety risks; meaningful social engagement in order to be a partner of choice; commitment to leading and environment stewardship practices and climate goals; and a diverse, inclusive and equitable workplace.
- **World-Class Portfolio:** The combined portfolio will have the industry's highest concentration of Tier 1 gold assets,² primarily in favourable, low-risk mining jurisdictions, as well as the industry's largest gold reserve and resource base.³ The high quality production portfolio alongside an extensive portfolio of greenfield and brownfield growth options and a meaningful increase in copper reserves will position the Merged Group to drive strong, stable and lasting returns over many decades.
- **Delivering Synergies:** Newmont's scalable, integrated operating model is expected to support the anticipated delivery of approximately \$500 million in annual pre-tax synergies within 24 months of implementing the Scheme, leveraging our integration experience from the 2019 acquisition of Goldcorp Inc. Further value creation opportunities are anticipated over time as the transaction brings together key talent and processes in complementary jurisdictions and ore bodies, including, among other things, the benefits from the experience of Newcrest's world-class block caving team.
- **Driving Capital Allocation:** The Merged Group will remain committed to our capital allocation strategy, which is underpinned by a strong and flexible investment grade balance sheet. Together with the sector's largest reserve and resource base, and even stronger, lower cost, diversified portfolio, the Merged Group can advance its most value-accretive development opportunities while remaining committed to Newmont's industry-leading, non-binding dividend framework to drive leading returns through the price cycle.

On this basis, the Newmont Board is confident in Newmont's ability to continue to deliver sector leading returns for the benefit of all our shareholders going forward.

On behalf of the Newmont Board and management team, we look forward to welcoming you as a Newmont securityholder following the successful implementation of the Scheme.

Yours sincerely,



Tom Palmer

President and Chief Executive Officer

Newmont Corporation

1. For additional information, see Newmont's August 2023 investor presentation (available on the Newmont website at <https://www.newmont.com/investors/events-and-presentations/default.aspx>).

2. A Tier 1 asset is defined by Newmont as +500k gold equivalent ounces/year consolidated, average AISC/oz in the lower half of the industry cost curve and a mine life >10 years in countries that are classified in the A and B rating ranges for each of Moody's, S&P and Fitch.

3. Comprising Newmont's Subpart 1300 resources and reserves (see section 6.4 for more information) and Newcrest's JORC reserves and resources (see section 5.5 for more information).

Event	Time and date
Special Dividend announcement date Newcrest to announce the Special Dividend on the ASX, PNGX and TSX (via SEDAR)	Before the Scheme Meeting
Receipt of proxy forms Latest time and date for receipt of proxy forms or powers of attorney by the Newcrest Share Registry for the Scheme Meeting	10.30am, Wednesday, 11 October 2023
Voting record date Time and date for determining eligibility to vote at the Scheme Meeting	7.00pm, Wednesday, 11 October 2023
Scheme Meeting	10.30am, Friday, 13 October 2023

If the Scheme is approved by Newcrest Shareholders

Second Court Date Court hearing to approve the Scheme	10.15am, Tuesday, 17 October 2023
Effective Date Court order lodged with ASIC and announcement to the ASX, PNGX and TSX (via SEDAR) Newcrest Shares will continue to trade ex-dividend on the ASX, PNGX and TSX after the Effective Date ⁴	Wednesday, 18 October 2023
Special Dividend Record Date (for determining entitlements to the Special Dividend)	7.00pm, Thursday, 19 October 2023
Last day to reposition Newcrest Shares between the Australian, Canadian and Papua New Guinean registers	Thursday, 26 October 2023
Last day of trading in Newcrest Shares Newcrest Shares will be suspended from trading on the ASX, PNGX and TSX from close of trading ⁵	Thursday, 26 October 2023
Newmont CDIs listed on the ASX Newmont Foreign Exempt Listing on the ASX for the purposes of the Newmont CDIs. First day trading in Newmont CDIs on the ASX (on a deferred settlement basis)	Friday, 27 October 2023
Newmont PDIs listed on the PNGX Newmont Exempt Issuer Listing on the PNGX for the purposes of the Newmont PDIs. First day trading in Newmont PDIs on the PNGX (on a deferred settlement basis)	Friday, 27 October 2023
Special Dividend Payment Date	Friday, 27 October 2023
Scheme Record Date (for determining entitlements to Scheme Consideration)	7.00pm, Monday, 30 October 2023
Implementation Date Issue of Scheme Consideration	Monday, 6 November 2023
Commencement of trading – Newmont Shares Commencement of trading of Newmont Shares issued under the Scheme on NYSE and TSX	Monday, 6 November 2023 (Eastern Time)
Commencement of normal trading – Newmont CDIs Holding statements for Newmont CDIs dispatched Commencement of normal trading of Newmont CDIs on the ASX (ASX: NEM)	Tuesday, 7 November 2023
Commencement of normal trading – Newmont PDIs Holding statements for Newmont PDIs dispatched Commencement of normal trading of Newmont PDIs on the PNGX (PNGX: NEM)	Tuesday, 7 November 2023
DRS statements – Newmont Shares DRS statements for Newmont Shares dispatched	Monday, 13 November 2023
Ineligible Foreign Shareholders Payment of the Net Cash Proceeds	By no later than Monday, 4 December 2023

Unless otherwise indicated, all times and dates in the above timetable are references to the time and date in Melbourne, Australia and all such times and dates are subject to change. Certain times and dates are conditional on the approval of the Scheme by Newcrest Shareholders and by the Court. Any changes will be announced by Newcrest to the ASX, PNGX and TSX (via SEDAR) and notified on Newcrest's website at www.newcrest.com.

4. In order to be entitled to both the Special Dividend and the Scheme Consideration, Newcrest Shareholders must hold their Newcrest Shares on both the Special Dividend Record Date and Scheme Record Date. See section 4.6 for further details.

5. The TSX has granted permission for Newcrest Shares to trade on a T+1 basis during the course of trading on Thursday, 26 October 2023. Non-registered holders of Newcrest Shares on the Canadian Register should note that full restrictions will be imposed by each of CDS and the Depository Trust Company over Newcrest Shares on and from 4.30pm on Friday, 27 October 2023 (Eastern Time) such that there cannot be any trades or withdrawals prior to the Scheme Record Date. These holders should refer to the bulletins published by each of CDS and the Depository Trust Company for further details on trading limitations that may be imposed.

1. Key considerations relevant to your vote

1.1 Newcrest Board recommendation

The Newcrest Directors unanimously recommend that you vote in favour of the Scheme, in the absence of a Superior Proposal and subject to the Independent Expert continuing to conclude that the Scheme is in the best interests of Newcrest Shareholders. Subject to the same conditions, each Newcrest Director will vote, or procure the voting of, any Newcrest Shares held or controlled by them, or held on their behalf, at the time of the Scheme Meeting in favour of the Scheme.

The Newcrest Directors consider that the reasons to vote in favour of the Scheme outweigh the potential reasons to vote against the Scheme.

1.2 Summary of reasons why you should vote in favour of the Scheme or why you may wish to vote against the Scheme

Reasons why you should vote in favour of the Scheme

✓	The Scheme Consideration, when aggregated with the Special Dividend, represents an attractive premium
✓	The Newcrest Directors unanimously recommend that you vote in favour of the Scheme, in the absence of a Superior Proposal and subject to the Independent Expert continuing to conclude that the Scheme is in the best interests of Newcrest Shareholders
✓	The Independent Expert has concluded that the Scheme is in the best interests of Newcrest Shareholders, in the absence of a superior proposal
✓	Combination of two high quality portfolios, creating a global leader in the gold sector with significant and growing exposure to copper, and an attractive jurisdictional risk profile
✓	Newcrest Shareholders will gain exposure to Newmont's portfolio and will be able to participate in any benefits of the Merged Group, including a more diversified portfolio with increased operational flexibility and financial scale to take advantage of value accretive development opportunities, including Newcrest's substantial growth options
✓	Newmont's expectation of value creation through the realisation of synergies if achieved
✓	Access to Newmont's non-binding dividend framework, ⁶ which has historically enabled Newmont to maintain a high dividend yield relative to gold peers through the price cycle
✓	Newcrest Shareholders at the Special Dividend Record Date are expected to receive a franked Special Dividend ⁷
✓	The Newcrest Share price may fall in the near-term if the Scheme is not implemented and in the absence of a Superior Proposal
✓	Some Newcrest Shareholders may be eligible for scrip-for-scrip rollover relief

Why you may wish to vote against the Scheme

✗	You may disagree with the Newcrest Directors' unanimous recommendation and/or the conclusion of the Independent Expert
✗	You may take the view that the exchange ratio does not reflect the underlying value of Newcrest's contribution to the Merged Group
✗	You may not wish to be an investor in the Merged Group and may be concerned that your exposure to Newcrest's assets is diluted in the Merged Group
✗	The risk profile of the Merged Group differs from Newcrest as a standalone entity
✗	You may consider that there is potential for a Superior Proposal to be made
✗	The implied value of the Scheme Consideration is not fixed and will depend on the price at which Newmont Shares trade at the Implementation Date
✗	The tax consequences of the Scheme may not suit your current financial position or tax circumstances

1.3 Reasons why you should vote in favour of the Scheme

a) The Scheme Consideration, when aggregated with the Special Dividend, represents an attractive premium

If the Scheme becomes Effective, Newcrest Shareholders will be entitled to receive Scheme Consideration of **0.400 Newmont Securities for each Newcrest Share** held on the Scheme Record Date (currently expected to be 7:00pm (Melbourne time) on Monday, 30 October 2023).⁸

In addition, Newcrest expects to pay a franked **Special Dividend of \$1.10 per Newcrest Share** prior to implementation of the Scheme, subject to the Scheme becoming Effective.⁹

6. Refer to sections 6.7 and 7.3(d) for further details on Newmont's non-binding dividend framework.

7. The franking of the Special Dividend amount is subject to change based on timing of implementation of the Scheme, business performance, finalisation of tax compliance matters relevant to the Newcrest Australian tax consolidated group, foreign exchange movements and an ATO Class Ruling. See sections 9.1(e) and 9.1(g)(2) for further information. In order to be entitled to both the Special Dividend and the Scheme Consideration, Newcrest Shareholders must hold their Newcrest Shares on both the Special Dividend Record Date and Scheme Record Date. See section 4.6 for further details.

8. Unless you are an Ineligible Foreign Shareholder, 'Newmont Security' refers to a Newmont Share, Newmont CDI and Newmont PDI. Newcrest Shareholders who hold their Newcrest Shares on the Australian Register or PNG Register will receive their Newmont Securities in the form of Newmont CDIs listed on ASX or Newmont PDIs listed on PNGX (respectively). Newcrest Shareholders who hold their Newcrest Shares on the Canadian Register will receive their Newmont Securities in the form of Newmont Shares.

9. The franking of the Special Dividend amount is subject to change based on timing of implementation of the Scheme, business performance, finalisation of tax compliance matters relevant to the Newcrest Australian tax consolidated group, foreign exchange movements and an ATO Class Ruling. See sections 9.1(e) and 9.1(g)(2) for further information.



1.3 Reasons why you should vote in favour of the Scheme *continued*

One way to assess the value to Newcrest Shareholders of the Scheme Consideration and the Special Dividend is to calculate the aggregate implied value of the Scheme Consideration together with the Special Dividend and compare that to the undisturbed closing price of A\$22.45 per Newcrest Share on 3 February 2023 (being the last trading day prior to the announcement of Newmont's initial proposal for Newcrest).

Based on the Newmont Share price of \$39.32 per share as at the Last Practicable Date, the aggregate of the Scheme Consideration and the Special Dividend has an implied value of A\$26.06.¹⁰ That represents a premium of 16.1% to the undisturbed closing Newcrest Share price on 3 February 2023 (being the last trading day prior to the announcement of Newmont's initial proposal for Newcrest).

That comparison does not take account of changes in the market and gold sector since 3 February 2023. Accordingly, another way to assess the value to Newcrest Shareholders of the Scheme Consideration and Special Dividend calculate an implied exchange ratio based on the aggregate of the Scheme Consideration and the Special Dividend for each Newcrest Share and then compare that to the ratio implied by the undisturbed closing prices of Newcrest and Newmont. This approach focuses on the relative value received by Newcrest Shareholders under the Newmont proposal compared to the relative value based on the share prices of the two companies at a point in time. Assessing the relative value of Newcrest and Newmont based on the undisturbed share prices prior to the initial Newmont proposal being made public allows a like for like comparison given movement in the share prices of both companies are influenced by similar factors, such as the macroeconomic environment or more specifically commodity prices and market sentiment.

This calculation gives rise to an implied exchange ratio of 0.428.¹¹ This comprises:

- the Scheme Consideration of the fixed exchange ratio of 0.400 Newmont Securities for each Newcrest Share held; and
- an exchange ratio of 0.028 attributed to the value of the Special Dividend.

The 0.428 implied exchange ratio represents an attractive:

- 17.9% premium to Newmont's initial proposal of an exchange ratio of 0.363 (as announced on 6 February 2023);¹²
- 36.2% premium to the exchange ratio of 0.314 calculated from the undisturbed closing share prices of Newcrest and Newmont on 3 February 2023 (being the last trading day prior to the announcement of Newmont's initial proposal for Newcrest);¹³ and
- 58.1% premium to the exchange ratio of 0.271 being the average ratio calculated from the closing share prices of Newcrest and Newmont over the 12 months trading to 3 February 2023 (being the last trading day prior to the announcement of Newmont's initial proposal for Newcrest).¹⁴

Newcrest and Newmont trading exchange ratios over the last 12 months as compared with various merger exchange ratios during the offer period.¹⁵



10. Based on: (1) exchange ratio of 0.400 per Scheme Consideration; (2) a franked Special Dividend of \$1.10 per share; and (3) an AUD:USD exchange rate of 0.6457 as at 1 September 2023.

11. Calculated as the equivalent number of Newmont Shares for an expected Special Dividend of \$1.10 using the Newmont Share price of \$39.32 as at the Last Practicable Date. In order to be entitled to both the Special Dividend and the Scheme Consideration, Newcrest Shareholders must hold their Newcrest Shares on both the Special Dividend Record Date and Scheme Record Date. See section 4.6 for further details.

12. Refer to the Newcrest announcement as at 6 February 2023, referred to as "Non-binding indicative offer from Newmont".

13. Undisturbed date represents the last trading day prior to Newcrest's 6 February 2023 announcement confirming Newmont's previous proposals. AUD:USD exchange rate of 0.6976 is applied.

14. Undisturbed date represents the last trading day prior to Newcrest's 6 February 2023 announcement confirming Newmont's previous proposals. Rolling daily AUD:USD exchange rate is applied.

15. The 0.271 12 month average exchange ratio is calculated as the average exchange ratio from the Newcrest and Newmont daily share prices and calculated at the daily AUD:USD exchange rate from 3 February 2022 to 3 February 2023. The 0.314 exchange ratio is calculated as the Newcrest and Newmont share prices as at 3 February 2023. The daily AUD:USD exchange rate of 0.6976 is applied to a Newmont Share price of A\$71.46 and is based on a Newcrest Share price of A\$22.45.

The 0.428 exchange ratio is calculated as at the Last Practicable Date and is based on an exchange ratio of 0.400 per the Scheme Consideration, a franked Special Dividend of \$1.10 per share, an AUD:USD exchange rate of 0.6457, a Newmont closing share price of \$39.32 and a Newcrest share price of A\$25.77 implying an offer price of A\$26.06.

1. Key considerations relevant to your vote

1.3 Reasons why you should vote in favour of the Scheme *continued*

b) The Newcrest Directors unanimously recommend that you vote in favour of the Scheme, in the absence of a Superior Proposal and subject to the Independent Expert continuing to conclude that the Scheme is in the best interests of Newcrest Shareholders

The Newcrest Directors unanimously recommend that Newcrest Shareholders vote in favour of the Scheme, in the absence of a Superior Proposal and subject to the Independent Expert continuing to conclude that the Scheme is in Newcrest Shareholders' best interests.

In reaching this unanimous recommendation, the Newcrest Directors considered the merits of the Scheme as outlined in this Scheme Booklet, including:

- the merits and strategic rationale of the Scheme (which are outlined in this section 1);
- the merits of continuing to operate Newcrest as a standalone entity; and
- the likelihood of a Superior Proposal emerging in the future.

The Newcrest Directors consider that the reasons to vote in favour of the Scheme outweigh the potential reasons to vote against the Scheme. The Newcrest Directors consider that the Scheme has the potential to realise greater benefits to Newcrest Shareholders than any other alternative currently available, including Newcrest continuing as a standalone entity.

Subject to the same conditions relating to their recommendation, each Newcrest Director will vote, or procure the voting of, any Newcrest Shares held or controlled by them, or held on their behalf, at the time of the Scheme Meeting in favour of the Scheme. The interests of the Newcrest Directors in Newcrest Shares are set out in section 11.1.

Since the first proposal by Newmont was announced on 6 February 2023 to the Last Practicable Date, no Superior Proposal has been received or has otherwise emerged and the Newcrest Board is not aware of any Superior Proposal that is likely to emerge.¹⁶

c) The Independent Expert has concluded that the Scheme is in the best interests of Newcrest Shareholders, in the absence of a superior proposal

The Independent Expert has concluded that the Scheme is in the best interests of Newcrest Shareholders, in the absence of a superior proposal.

The reasons why the Independent Expert reached these conclusions are set out in the Independent Expert's Report, a copy of which is included in Annexure 1. The Newcrest Directors encourage you to read this report in its entirety.

In forming this view, the Independent Expert's Report states that the overlap between the assessed value of the consideration (\$17.10-18.70 per Newcrest Share) and the underlying value of Newcrest (\$18.64-21.13 per Newcrest Share) is insufficient to meet the requirements for the Transaction (together with the Special Dividend) to be fair in terms of ASIC's regulatory guidelines (although it was demonstrably fair at the time of announcement). However, the Independent Expert's Report states there are good reasons to conclude that this analysis (required under the regulatory guidelines) provides, at best, an incomplete assessment of the Transaction (together with the Special Dividend), given its scrip nature and the overall volatility in market values across the gold sector in recent months.

In these circumstances:

- as a scrip based transaction, relative contributions analysis is also useful and relevant. Over an extended period, Newcrest Shareholders have consistently contributed ~25% of the market value of the Merged Group yet they are receiving ~32% of the market value of the Merged Group, representing a premium (or uplift) of around 30%;¹⁷ and
- the Transaction enables Newcrest Shareholders to retain their direct exposure to the gold sector by "rolling up" their investment into a larger, more diversified company (the world's largest gold miner), while capturing a meaningful premium (through the uplift in their share of the Merged Group) in the process, as well as benefitting from a higher dividend per share.

On this basis, the Independent Expert states that it could be argued that the Transaction (together with the Special Dividend) provides an exchange ratio that is equitable. Irrespective of the merits of this argument, this analysis supports the reasonableness of the Transaction (together with the Special Dividend). Other factors contributing to this opinion include:

- the limited prospects for a superior offer from an alternative acquirer; and
- the expectation that the Newcrest Shares would trade below the Independent Expert's assessed value of Newcrest in the absence of the Transaction.

As the Independent Expert notes, the value of the consideration will continue to fluctuate with movements in the Newmont share price and this could change the Independent Expert's view on fairness (although this would not change the opinion as to best interests).

Ultimately, the Independent Expert concludes that:

If a superior proposal does not emerge prior to the Scheme meeting, the choice is essentially between the Newmont Transaction and the status quo. In this case, Grant Samuel's judgement is that the Newmont Transaction (including the Scheme) would be in the best interests of Newcrest shareholders.

16. If a Superior Proposal is received, Newcrest is subject to certain exclusivity arrangements. These exclusivity arrangements may diminish the possibility of Newcrest receiving a Superior Proposal. Refer to section 11.4(e) for further details.

17. The percentages set out here reflect the share of combined sharemarket value being contributed and received (based on the Scheme Consideration and expected Special Dividend) by Newcrest Shareholders, as described in section 7.4 of the Independent Expert's Report. These percentages are to be distinguished from the 31% of Newmont's total shares to be received by Newcrest Shareholders on implementation of the Scheme, which is referenced elsewhere in this Scheme Booklet.



1.3 Reasons why you should vote in favour of the Scheme *continued*

d) Combination of two high quality portfolios, creating a global leader in the gold sector with significant and growing exposure to copper, and an attractive jurisdictional risk profile

The Merged Group will combine Newcrest's and Newmont's high quality portfolios and diversify Newcrest Shareholders' exposure to producing assets. The combination of Newcrest's and Newmont's assets will position the Merged Group as the global leader in the gold sector with the industry's largest gold reserve and resource base.¹⁸

Notably, Newcrest Shareholders will also retain exposure to Newcrest's significant and growing copper portfolio, which will contribute 11 Mt Probable Reserves, 25 Mt Measured and Indicated Resources and 4.8 Mt Inferred Resources to the Merged Group.¹⁹

In addition, the jurisdictional risk profile of the Merged Group is expected to be more attractive compared to the current jurisdictional risk profile of Newcrest as a standalone entity. The Merged Group will have a significant number of Tier 1 assets,²⁰ including in favourable, low-risk mining jurisdictions.²¹

e) Newcrest Shareholders will gain exposure to Newmont's portfolio and will be able to participate in any benefits of the Merged Group, including a more diversified portfolio with increased operational flexibility and financial scale to take advantage of value accretive development opportunities, including Newcrest's substantial growth options

On implementation of the Scheme, Newcrest Shareholders are expected to own approximately 31.1% of the Merged Group. Through this interest in the Merged Group, Newcrest Shareholders will be able to participate in the potential benefits of combining Newcrest and Newmont, while also retaining exposure to Newcrest's assets.

For instance, the Merged Group will have a diversified portfolio of high-quality assets that are at different stages of the production and development cycle for both gold and copper producing assets and projects. These assets are balanced across production assets, brownfield expansions, projects in construction, advanced projects and early-stage greenfield opportunities. A diversified portfolio of assets at different stages of the production and development cycle can provide operational flexibility to pursue growth, improve working capital and cash flows, and help maintain a healthy balance sheet.

In addition, if the Scheme is implemented, the Merged Group will have on a pro forma basis:

- a market capitalisation of A\$70.2 billion;²² and
- net income of \$972 million in the six months ended 30 June 2023.²³

Newcrest Shareholders are expected to benefit from the increased financial scale of the Merged Group as compared to Newcrest on a standalone basis. The Merged Group's financial scale is expected to bring capital allocation benefits and enable it to take advantage of value accretive opportunities, including the development of Newcrest's and Newmont's existing assets and projects at different stages of the production and development cycle (as outlined above), as well as any new growth initiatives proposed by Newmont for the Merged Group.

Section 7 sets out more detail in relation to the Merged Group, including the Merged Group Pro Forma Historical Financial Information.

f) Newmont's expectation of value creation through the realisation of synergies if achieved

Newmont has identified a number of synergies it expects to realise as a result of the Scheme which, if achieved, would create value for holders of Newmont Securities (including the Newmont Securities issued to Newcrest Shareholders under the Scheme) and deliver stronger returns than either Newcrest or Newmont could achieve on a standalone basis.

These include general and administrative and supply chain synergies, as well as synergies from Newmont's full potential continuous improvement program. Refer to section 7.2 for more detail in relation to Newmont's expected synergies.

These expected synergies have been identified by Newmont and are the responsibility of Newmont. Newcrest and its officers and advisers do not assume any responsibility for any statement relating to synergies expected to be realised by Newmont as a result of the Scheme.

g) Access to Newmont's non-binding dividend framework, which has historically enabled Newmont to maintain a high dividend yield relative to gold peers through the price cycle

Newcrest Shareholders will gain access to Newmont's non-binding dividend framework, which has historically enabled Newmont to maintain a high dividend yield relative to gold peers through the price cycle. Newmont's capital allocation strategy and dividend framework has returned over \$4.5 billion to shareholders since October 2020.

Unlike many of its peers, the Newmont non-binding dividend framework for 2023 is linked to the gold price and includes both a:

- fixed component of \$1.00 per share at reserve pricing assumption of \$1,400 per ounce; and
- variable component, which is calibrated in gold price increments of \$300 per ounce and is assessed annually in line with the business planning cycle, macroeconomic environment and level of reinvestment in the business.

Additionally, although it is not required to do so, Newmont has historically declared quarterly cash dividends on Newmont Shares, which, could, as and to the extent declared by the Newmont Board, enable the Merged Group shareholders to benefit from the receipt of more frequent returns throughout the year.²⁴

18. Based on Newcrest's JORC reserves and resources (see section 5.5 for more information) and Newmont's Subpart 1300 resources and reserves (see section 6.4 for more information).

19. As at 30 June 2023. For tonnes and grade breakdown by confidence category refer to Table 5.5.1 for Measured and Indicated Resources, Table 5.5.2 for Inferred Resources and Table 5.5.7 for Probable Reserves as set out in section 5.5.

20. A Tier 1 asset is defined by Newmont as +500k gold equivalent ounces/year consolidated, average AISC per ounce in the lower half of the industry cost curve and a mine life >10 years in countries that, on average, are classified in the A and B rating ranges by Moody's, S&P or Fitch.

21. Newmont operates in certain jurisdictions that are subject to specific risks that Newcrest Shareholders will be exposed to if the Scheme is implemented, some of which are described in section 8.2.

22. Based on: (1) the pro forma shares on issue as at the Last Practicable Date, being the aggregate of 894,230,732 Newcrest Shares (multiplied by the 0.400 exchange ratio) and 794,795,993 Newmont Shares; (2) the Newmont Share price of \$39.32 as at the Last Practicable Date; and (3) an AUD:USD exchange rate of 0.6457 as at the Last Practicable Date.

23. Based on the Merged Group Pro Forma Historical Statements of Operations set out in section 7.7(c) and using the basis of preparation set out in section 7.7(b).

24. Refer to sections 6.7 and 7.3(d) for further details on Newmont's non-binding dividend framework.

1. Key considerations relevant to your vote

1.3 Reasons why you should vote in favour of the Scheme *continued*

h) Newcrest Shareholders at the Special Dividend Record Date are expected to receive a franked Special Dividend

Newcrest expects to pay a franked Special Dividend of \$1.10 per Newcrest Share, subject to the Scheme becoming Effective.²⁵ The final decision on the amount of the Special Dividend will be made by the Newcrest Directors. This decision will be communicated to Newcrest Shareholders by way of an ASX, PNGX and TSX (via SEDAR) announcement before the Scheme Meeting. If the Scheme becomes Effective, the Special Dividend will be paid on the Special Dividend Payment Date (currently expected to be Friday, 27 October 2023).

A fully franked Special Dividend of \$1.10 per Newcrest Share would have approximately \$0.47 per Newcrest Share of franking credits attached (converted into Australian dollars at the spot rate on the relevant payment date).²⁵ Newcrest Shareholders may be entitled to a tax offset equal to the franking credits attached to the Special Dividend.

In assessing the value to them of any Special Dividend, Newcrest Shareholders should seek independent professional tax advice as to whether or not the receipt of any Special Dividend and any entitlement to franking credits is beneficial to them based on their own particular circumstances. In particular, Newcrest Shareholders should note that, depending on the timing of when they acquired their Newcrest Shares, there may be differences in the tax consequences for them. Refer to section 9 for further details.

i) The Newcrest Share price may fall in the near-term if the Scheme is not implemented and in the absence of a Superior Proposal

If the Scheme does not proceed, and no comparable proposal or Superior Proposal is received by the Newcrest Board, the Newcrest Share price is expected to fall.

Since market close on 3 February 2023 (being the last day on which Newcrest Shares traded before the initial offer from Newmont was announced), the Newcrest Share price has increased 14.8% up to a closing price of A\$25.77 on Last Practicable Date, outperforming its peers on the ASX Gold Index and VanEck Miners Index by 9.1% and 11.1% respectively. See figure below for further information. If the Scheme is not implemented, there is a risk that Newcrest may instead trade in line with its peers on the ASX Gold Index and VanEck Miners Index.

Newcrest Share price performance relative to ASX Gold Index and VanEck Miners Index.

Price performance of Newcrest relative to the ASX Gold Index and the VanEck Miners Index since 3 February 2023

40% Share price performance (\$A, Rebased)

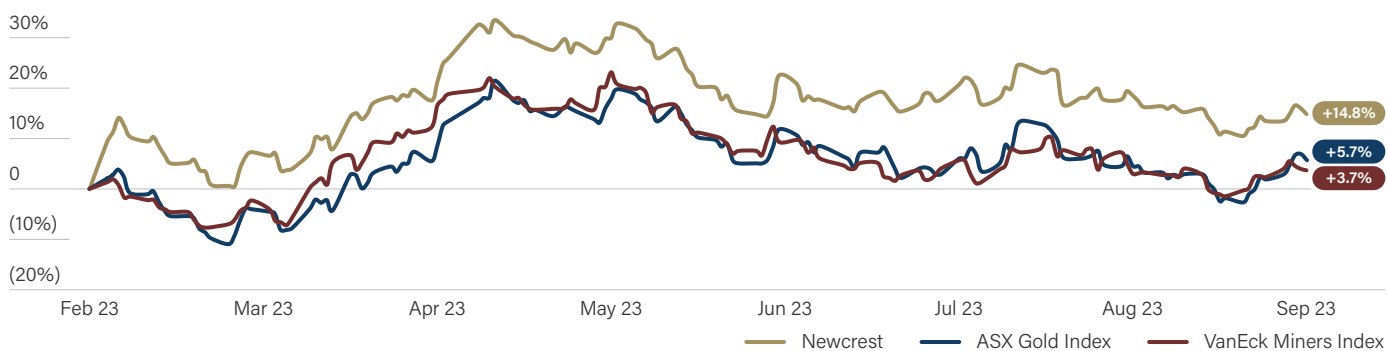

j) Some Newcrest Shareholders may be eligible for scrip-for-scrip roll-over relief

Scheme Shareholders who are Australian tax residents (and are not tax residents in any other country) and who make a capital gain from the disposal of their Scheme Shares may be eligible for scrip-for-scrip roll-over relief. Scrip-for-scrip roll-over relief allows these Scheme Shareholders to defer the capital gain they made from the disposal of their Scheme Shares under the Scheme.

Newcrest is seeking confirmation from the ATO that scrip-for-scrip roll-over relief is available for these Scheme Shareholders in the Class Ruling.

Section 9 provides a general description of certain Australian, United Kingdom and United States taxation consequences for Scheme Shareholders.

1.4 Why you may wish to vote against the Scheme

a) You may disagree with the Newcrest Directors' unanimous recommendation and/or the conclusion of the Independent Expert's Report

Despite the unanimous recommendation of the Newcrest Directors to vote in favour of the Scheme and the conclusion of the Independent Expert that the Scheme is in the best interests of Newcrest Shareholders, you may disagree that the Scheme is in your best interests.

b) You may take the view that the exchange ratio does not reflect the underlying value of Newcrest's contribution to the Merged Group

You may take the view that the exchange ratio of 0.400, despite representing Newmont's 'best and final' offer, does not give existing Newcrest Shareholders an appropriate share of the Merged Group and the combination benefits of the two businesses. On implementation of the Scheme, Newcrest Shareholders are expected to own approximately 31.1% of the Merged Group and existing Newmont Stockholders are expected to own approximately 68.9%.

Such a view should be considered having regard to the attractive premium represented by the Scheme Consideration and Special Dividend. Refer to section 1.3(a) for more information regarding the attractive premium.

25. The franking of the Special Dividend amount is subject to change based on timing of implementation of the Scheme, business performance, finalisation of tax compliance matters relevant to the Newcrest Australian tax consolidated group, foreign exchange movements and an ATO Class Ruling. See sections 9.1(e) and 9.1(g)(2) for further information.



1.4 Why you may wish to vote against the Scheme *continued*

c) You may not wish to be an investor in the Merged Group and you may be concerned that your exposure to Newcrest's assets is diluted in the Merged Group

If the Scheme is implemented, Newcrest Shareholders will become investors in the Merged Group and will have a reduced exposure to Newcrest's existing assets as part of the Merged Group. You may wish for Newcrest to remain a standalone entity because you invested in Newcrest to seek exposure to a company with the specific qualities of Newcrest. In particular, you may consider that, despite the risks relevant to Newcrest's potential future operations and the reasons to vote in favour of the Scheme set out in section 1.3, Newcrest may be able to return greater value from its assets by remaining a standalone entity or by seeking alternative corporate transactions in the future. As a result, you may not want to have investment exposure to Newmont and its assets by holding Newmont Securities.

d) The risk profile of the Merged Group differs from Newcrest as a standalone entity

If the Scheme is implemented, there will be a change in the risk profile to which Newcrest Shareholders are exposed. Currently, Newcrest Shareholders are exposed to various risks as a result of their investment in Newcrest. If the Scheme is implemented, Newcrest Shareholders will be exposed to the risks of the Merged Group. Some of the risks of the Merged Group are either related to the resources sector generally or already affect the Newcrest business which will form part of the Merged Group. Accordingly, Newcrest Shareholders already have some exposure to these risks.

While Newcrest and Newmont are both gold and copper producers, the operational profile, capital structure, asset geography and board and management of the Merged Group will be different from that of Newcrest as a standalone entity.

You may also consider that the risks of the Merged Group (including those set out in section 8.2) are greater than the risks of Newcrest as a standalone entity.

In respect to those Newcrest Shareholders who receive Newmont CDIs or Newmont PDIs as Scheme Consideration, the market for Newmont CDIs and/or Newmont PDIs may be less liquid than the market for Newmont Shares on NYSE and TSX. This may reduce the trading volume of Newmont CDIs and/or Newmont PDIs and the speed at which they can be disposed. This may result in the Newmont CDIs and/or Newmont PDIs trading at a discount to Newmont Shares on NYSE and TSX.

Further detail on risks is set out in section 8.

e) You may consider that there is potential for a Superior Proposal to be made

You may consider that a Superior Proposal could emerge in the future. However, since the first proposal by Newmont was announced on 6 February 2023 to the Last Practicable Date, the Newcrest Directors are not aware of, and have not received, any Superior Proposal. If a Superior Proposal is received, Newcrest is subject to certain exclusivity arrangements. These exclusivity arrangements may diminish the possibility of Newcrest receiving a Superior Proposal. However, the exclusivity arrangements do not restrict Newcrest from taking any action or inaction in respect of a Competing Proposal to the extent that the Newcrest Board determines (acting in good faith and after receiving external advice) that the Competing Proposal could reasonably be considered to become a Superior Proposal and failing to take or not take such action would likely breach the fiduciary or statutory duties of Newcrest's board members. Refer to section 11.4(e) for further details.

If a Superior Proposal emerges, the Newcrest Directors will consider the proposal and advise Newcrest Shareholders accordingly (subject to the exclusivity provisions of the Scheme Implementation Deed).

f) The implied value of the Scheme Consideration is not fixed and will depend on the price at which Newmont Shares trade at the Implementation Date

The Scheme Consideration is based on a fixed exchange ratio and as a result the implied value of the Scheme Consideration will change over time depending on the prevailing share price of Newmont and the AUD:USD exchange rate. As a result, the implied value of the Scheme Consideration is not certain and is likely to change, including between the date of this Scheme Booklet and the Implementation Date (being the date that the Newmont Securities are issued under the Scheme).

Assuming the AUD:USD exchange rate remains constant, the implied value of the Scheme Consideration that you receive for your Newcrest Shares will decrease if the Newmont Share price decreases. However, if there is an increase in the Newmont Share price, the implied value of the Scheme Consideration that you receive for your Newcrest Shares will also increase.

Notwithstanding potential short-term fluctuations in the Newmont Share price (whether price decreases or increases), including between the date of this Scheme Booklet and the Implementation Date, you are encouraged to consider the potential investment in the Merged Group over the longer-term and should have regard to the potential benefits associated with an investment in the Merged Group, including those set out in section 1.3.

g) The tax consequences of the Scheme may not suit your current financial position or tax circumstances

The tax consequences of the Scheme will depend on your personal situation. You may consider that the tax consequences of disposing your Newcrest Shares pursuant to the Scheme are not attractive to you. This includes the fact that any dividends paid by Newmont after implementation of the Scheme will not be franked for Australian tax purposes.

Newcrest Shareholders should read the tax implications of the Scheme outlined in section 9, which also includes a description of the United States tax implications of holding and disposing of Newmont Securities and payment of dividends on Newmont Securities. However, section 9 is general in nature, and Newcrest Shareholders should consult with their own independent professional tax advisers regarding the tax implications of the Scheme.

2. Frequently asked questions

This section 2 answers some frequently asked questions relating to the Scheme. It is not intended to address all relevant issues for Newcrest Shareholders. This section 2 should be read together with all other parts of this Scheme Booklet.

Question	Answer	More information
Overview of the Scheme		
Why have I received this Scheme Booklet?	This Scheme Booklet has been sent to you because you are a Newcrest Shareholder and you are being asked to vote on the Scheme. This Scheme Booklet is intended to help you to consider and decide on how to vote on the Scheme at the Scheme Meeting.	Section 4
What is the Scheme?	The Scheme is a scheme of arrangement between Newcrest and the Scheme Shareholders. A "scheme of arrangement" is a statutory procedure in the Corporations Act that is commonly used in transactions in Australia that may result in a change of ownership or control of a company. In addition to requiring court approval, schemes of arrangement require a shareholder vote in favour of a resolution to implement the scheme of arrangement by the Requisite Majorities.	Section 4 and Annexure 3
What will be the effect of the Scheme?	If the Scheme is implemented: <ul style="list-style-type: none"> – all Scheme Shares will be transferred to Newmont Overseas; – Newcrest will become a wholly owned indirect Subsidiary of Newmont; – all Newcrest Shareholders as at the Scheme Record Date (whether they voted for or against the Scheme, or did not vote) will receive the Scheme Consideration, unless the shareholder is an Ineligible Foreign Shareholder; – all Newcrest Shareholders as at the Special Dividend Record Date will receive the Special Dividend; and – Newcrest will be delisted from the ASX, PNGX and TSX. 	Section 4 and Annexure 3
How will the Scheme be implemented?	Details on how the Scheme will be implemented are described in section 4.	Section 4 and Annexure 3
Who is Newmont?	Newmont, a Delaware corporation, is the world's leading gold company and a producer of copper, silver, zinc and lead. Newmont's common stock is listed on NYSE (under the symbol "NEM") and TSX (under the symbol "NGT"). Newmont has a market capitalisation of approximately \$31 billion as at the Last Practicable Date. Newmont has offices in the United States, Australia, Canada, and Ghana, and its portfolio of mining assets includes operations and projects in the United States, Australia, Canada, Chile, Ghana, Mexico, Peru, Argentina, Dominican Republic and Suriname.	Section 6.1
Who is Newmont Overseas?	Newmont Overseas is an Australian proprietary company limited by shares that was incorporated on 9 May 2023 and is a wholly owned indirect Subsidiary of Newmont. Prior to the Scheme, it has not and will not conduct any business and does not currently own any assets or have any liabilities. If the Scheme is implemented, Newmont Overseas will directly hold all the shares in Newcrest.	Section 6.1(c)
What should I do?	You should take the following steps in relation to the Scheme: <ul style="list-style-type: none"> – carefully read this Scheme Booklet in its entirety and seek advice if you have any questions; and – vote on the Scheme. 	Section 3
Recommendation and intentions		
What do the Newcrest Directors recommend?	The Newcrest Directors unanimously recommend that you vote in favour of the Scheme, in the absence of a Superior Proposal and subject to the Independent Expert continuing to conclude that the Scheme is in the best interests of Newcrest Shareholders. Reasons for this recommendation and other relevant considerations are set out in section 1.	Letter from the Chairman of the Newcrest Board and section 1.1
How are the Newcrest Directors intending to vote?	Each Newcrest Director will vote, or procure the voting of, any Newcrest Shares held or controlled by them at the time of the Scheme Meeting in favour of the Scheme at the Scheme Meeting, in the absence of a Superior Proposal and subject to the Independent Expert continuing to conclude that the Scheme is in the best interests of Newcrest Shareholders.	Letter from the Chairman of the Newcrest Board and section 1.1



Question	Answer	More information
Key considerations relevant to your vote		
What is the conclusion of the Independent Expert?	<p>The Independent Expert has concluded that the Scheme is in the best interests of Newcrest Shareholders, in the absence of a superior proposal.</p> <p>The reasons why the Independent Expert reached these conclusions are set out in the Independent Expert's Report, a copy of which is included in Annexure 1. The Newcrest Directors encourage you to read this report in its entirety.</p>	Letter from the Chairman of the Newcrest Board, section 1.3(c) and Annexure 1
What are the reasons why you should vote in favour of the Scheme?	<ul style="list-style-type: none"> – The Scheme Consideration, when aggregated with the Special Dividend, represents an attractive premium. – The Newcrest Directors unanimously recommend that Newcrest Shareholders vote in favour of the Scheme, in the absence of a Superior Proposal and subject to the Independent Expert continuing to conclude that the Scheme is in the best interests of Newcrest Shareholders. – The Independent Expert has concluded that the Scheme is in the best interests of Newcrest Shareholders, in the absence of a superior proposal. – Combination of two high quality portfolios, creating a global leader in the gold sector with significant and growing exposure to copper, and an attractive jurisdictional risk profile. – Newcrest Shareholders will gain exposure to Newmont's portfolio and will be able to participate in any benefits of the Merged Group, including in a more diversified portfolio with increased operational flexibility and financial scale to take advantage of value accretive development opportunities, including Newcrest's substantial growth options. – Newmont's expectation of value creation through realisation of synergies if achieved. – Access to Newmont's non-binding dividend framework,²⁶ which has historically enabled Newmont to maintain a high dividend yield relative to gold peers through the price cycle. – Newcrest Shareholders at the Special Dividend Record Date are expected to receive a franked Special Dividend.²⁷ – The Newcrest Share price may fall in the near-term if the Scheme is not implemented and in the absence of a Superior Proposal. – Some Newcrest Shareholders may be eligible for scrip-for-scrip rollover relief. 	Section 1.3
What are the reasons why you may wish to vote against the Scheme?	<ul style="list-style-type: none"> – You may disagree with the Newcrest Directors' unanimous recommendation and/or the conclusion of the Independent Expert. – You may take the view that the exchange ratio does not reflect the underlying value of Newcrest's contribution to the Merged Group. – You may not wish to be an investor in the Merged Group and may be concerned that your exposure to Newcrest's assets is diluted in the Merged Group. – The risk profile of the Merged Group differs from Newcrest as a standalone entity. – You may consider that there is potential for a Superior Proposal to be made. – The tax consequences of the Scheme may not suit your current financial position or tax circumstances. – The implied value of the Scheme Consideration is not fixed and will depend on the price at which Newmont Shares trade at the Implementation Date. 	Section 1.4
What are the risks relating to the Newcrest Group if the Scheme is not implemented?	<p>If the Scheme does not proceed, Newcrest will continue as a standalone entity and Newcrest Shareholders will retain their Newcrest Shares. In these circumstances, Newcrest may be subject to the risks set out in section 8.4.</p>	Section 8.4
What are the risks associated with the Merged Group?	<p>An investment in the Merged Group is subject to several key risks, including:</p> <ul style="list-style-type: none"> – the Merged Group failing to realise benefits, including synergies; – integration risk; – risks relating to the Scheme (such as transaction costs); – risks relating to implementation of the Scheme; and – risks relating to the Merged Group's businesses and operations. <p>Further details on risks are detailed in section 8.2.</p>	Section 8.2

26. Refer to sections 6.7 and 7.3(d) for further details on Newmont's non-binding dividend framework.

27. The franking of the Special Dividend amount is subject to change based on timing of implementation of the Scheme, business performance, finalisation of tax compliance matters relevant to the Newcrest Australian tax consolidated group, foreign exchange movements and an ATO Class Ruling. See sections 9.1(e) and 9.1(g)(2) for further information.

2. Frequently asked questions

Question	Answer	More information
Overview of the Scheme Consideration		
What is the Scheme Consideration?	<p>If the Scheme is implemented, Newcrest Shareholders will be entitled to receive the Scheme Consideration of 0.400 Newmont Securities for each Newcrest Share held on the Scheme Record Date (currently expected to be 7.00pm (Melbourne time) on Monday, 30 October 2023).</p> <p>Newcrest Shareholders who are Ineligible Foreign Shareholders will not receive Newmont Securities. Instead, they will receive their pro rata share of the Net Cash Proceeds.</p>	Sections 4.2, 4.3 and 11.5
Will I receive Newmont Shares, Newmont CDIs or Newmont PDIs?	<p>Under the Scheme, Newcrest Shareholders (other than Ineligible Foreign Shareholders) who hold their Newcrest Shares on the:</p> <ul style="list-style-type: none"> – Australian Register will receive Newmont CDIs; – PNG Register will receive Newmont PDIs; and – Canadian Register will receive Newmont Shares. <p>Newcrest Shareholders who are Ineligible Foreign Shareholders will not receive Newmont Securities. Instead, they will receive their pro rata share of the Net Cash Proceeds.</p> <p>Newcrest Shareholders can reposition their Newcrest Shares between the Australian Register, PNG Register and Canadian Register on or before Thursday, 26 October 2023. This includes a Newcrest Shareholder who holds their Newcrest Shares on the Canadian Register repositioning that holding to the Australian Register or PNG Register to allow that shareholder (provided they are not an Ineligible Foreign Shareholder) to be entitled to receive Newmont CDIs or Newmont PDIs and participate in deferred settlement trading on the ASX and PNGX between Friday, 27 October 2023 and Monday, 6 November 2023 (see sections 7.8(f) and 11.6(b)(1)).</p> <p>Following implementation of the Scheme, Newcrest Shareholders can transmute Newmont CDIs and Newmont PDIs into Newmont Shares and vice versa. Further details on this process are set out in sections 7.8(c) and 11.6.</p>	Section 4.2
What is the premium represented by the Scheme Consideration and Special Dividend?	<p>Based on the Newmont Share price of \$39.32 per share as at the Last Practicable Date, the aggregate of the Scheme Consideration and the Special Dividend has value of A\$26.06.²⁸ That represents a premium of 16.1% to the undisturbed closing Newcrest Share price on 3 February 2023 (being the last trading day prior to the announcement of Newmont's initial proposal for Newcrest).</p> <p>That comparison above does not take account of changes in the market and the gold sector since 3 February 2023. Accordingly, another way to assess the value to Newcrest Shareholders of the Scheme Consideration and Special Dividend is to calculate an implied exchange ratio based on the aggregate of the Scheme Consideration and the Special Dividend for each Newcrest Share and then compare that to the ratio implied by the undisturbed closing prices of Newcrest and Newmont. This approach focuses on the relative value received by Newcrest Shareholders under the Newmont proposal compared to the relative value based on the share prices of the two companies at a point in time. Assessing the relative value of Newcrest and Newmont based on the undisturbed share prices prior to the initial Newmont proposal being made public allows a like for like comparison given movement in the share prices of both companies are influenced by similar factors, such as the macroeconomic environment or more specifically commodity prices and market sentiment.</p> <p>This calculation gives rise to an implied exchange ratio of 0.428.²⁹ This comprises:</p> <ul style="list-style-type: none"> – the Scheme Consideration of the fixed exchange ratio of 0.400 Newmont Securities for each Newcrest Share held; and – an exchange ratio of 0.028 attributed to the value of the Special Dividend. <p>The 0.428 implied exchange ratio represents an attractive:</p> <ul style="list-style-type: none"> – 17.9% premium to Newmont's initial proposal of an exchange ratio of 0.363 (as announced on 6 February 2023);³⁰ – 36.2% premium to the exchange ratio of 0.314 calculated from the undisturbed closing share prices of Newcrest and Newmont on 3 February 2023 (being the last trading day prior to the announcement of Newmont's initial proposal for Newcrest);³¹ and – 58.1% premium to the exchange ratio of 0.271 being the average ratio calculated from the closing share prices of Newcrest and Newmont over the 12 months trading to 3 February 2023 (being the last trading day prior to the announcement of Newmont's initial proposal for Newcrest).³² 	Letter from the Chairman of the Newcrest Board and section 1.3

28. Based on: (1) exchange ratio of 0.400 per Scheme Consideration; (2) a franked Special Dividend of \$1.10 per share; and (3) an AUD:USD FX rate of 0.6457 as at 1 September 2023.

29. Calculated as the equivalent number of Newmont Shares for an expected Special Dividend of \$1.10 using the Newmont Share price of \$39.32 as at the Last Practicable Date.

30. Refer to the Newcrest announcement as at 6 February 2023, referred to as "Non-binding indicative offer from Newmont".

31. Undisturbed date represents the last trading day prior to Newcrest's 6 February 2023 announcement confirming Newmont's previous proposals. AUD:USD exchange rate of 0.6976 is applied.

32. Undisturbed date represents the last trading day prior to Newcrest's 6 February 2023 market release announcement Newmont's previous proposals. Rolling daily AUD:USD exchange rate is applied.

2. Frequently asked questions



Question	Answer	More information
Overview of the Scheme Consideration continued		
Who is entitled to receive the Scheme Consideration?	You are entitled to receive the Scheme Consideration if you hold Newcrest Shares on the Scheme Record Date (currently expected to be 7:00pm (Melbourne time) on Monday, 30 October 2023). Newcrest Shareholders who are Ineligible Foreign Shareholders will not receive Newmont Securities. Instead, they will receive their pro rata share of the Net Cash Proceeds.	Section 4.2(c)
When will I receive the Scheme Consideration?	Newmont Overseas will provide (or procure the provision of) the Scheme Consideration to Newcrest Shareholders (other than Ineligible Foreign Shareholders) on the Implementation Date (currently expected to be Monday, 6 November 2023).	Key dates and section 4.2
What are the Newmont Shares?	The Newmont Shares issued to Scheme Shareholders, in book-entry form, will be fully paid shares of common stock of Newmont tradeable on NYSE and TSX. Newmont has agreed to use its best endeavours to ensure that the Newmont Shares are approved by NYSE and TSX and ensure that trading in the Newmont Shares commences on a normal settlement basis on NYSE and TSX from the first Business Day after the Implementation Date (New York time). Newmont will apply for the listing of Newmont PDIs (over a certain number of Newmont Shares) on PNGX.	Section 7.8(a)
What are CDIs?	CDIs, or CHESS Depository Interests, are a type of depository receipt that allows investors in foreign companies (such as Newmont), to obtain all the economic benefit of owning securities in the foreign company (such as Newmont Shares) without holding legal title to the securities. The underlying securities represented by a CDI are registered in the name of the depository nominee (CDN) as legal owner, or held in the form of beneficial ownership, but all of the economic benefits attaching to the underlying securities accrue to the CDI holder. When CDIs are quoted on the ASX, the underlying securities are regarded as having been quoted on the ASX.	Section 7.8(b)
What are the Newmont CDIs?	The Newmont CDIs issued to Scheme Shareholders will represent a unit of beneficial ownership in a Newmont Share which is registered in the name of CDN, or held in the form of beneficial ownership. Deferred settlement trading of Newmont CDIs is expected to be available on the ASX from Friday, 27 October 2023. Newmont CDIs are expected to commence trading on the ASX on a normal settlement basis on the ASX from Tuesday, 7 November 2023.	Sections 7.8(b) and 7.8(c)
What are the differences between Newmont Shares and Newmont CDIs?	Newmont Shares will be fully paid shares in Newmont, ranking equally in all respects with all other Newmont Shares then on issue. Newmont Shares will be listed and traded on NYSE in US dollars and TSX in Canadian dollars. Except for certain differences noted in section 7.8(d), a Newmont CDI will have rights that are economically equivalent to the rights attaching to a Newmont Share. Newmont CDIs will be quoted and traded on the ASX in Australian dollars under the symbol "NEM". A holder of Newmont CDIs can, however, elect at any time to convert those Newmont CDIs to an equivalent number of Newmont Shares (via a process referred to as "transmuting" Newmont CDIs to Newmont Shares). A holder of Newmont CDIs will not be a registered Newmont Stockholder. Instead, Newmont Shares represented by Newmont CDIs will be held in the name of CDN, a Subsidiary of the ASX. A Newmont CDI holder can direct CDN to vote the Newmont Shares represented by its Newmont CDIs in accordance with the Newmont CDI holder's directions. Further details on the difference between Newmont Shares and Newmont CDIs are set out in section 7.8(d).	Section 7.8(d)
What are the risks relating to Newmont Shares and Newmont CDIs?	There are several risks associated with Newmont Shares and Newmont CDIs including: – the market for Newmont CDIs may be less liquid than the market for Newmont Shares; – the price of Newmont CDIs will be subject to, and reflect movements in, the Newmont Share price and the AUD:USD exchange rate; and – the market price and volume of Newmont Shares may be subject to significant fluctuations. Further details on the risks related to Newmont Shares and Newmont CDIs are set out in section 8.3.	Section 8.3
Can I convert my Newmont CDIs into Newmont Shares?	Newmont CDIs can be transmuted into Newmont Shares and vice versa at any time following the Implementation Date, by contacting the Newmont CDI registry or Newmont Share Registry (as applicable).	Sections 7.8(b) and 7.8(c)

2. Frequently asked questions

Question	Answer	More information
Overview of the Scheme Consideration continued		
What are PDIs?	<p>PDIs are a type of depository receipt used to enable trading on the PNGX of financial products issued by entities domiciled in countries whose laws may not recognise uncertificated holders or electronic transfer of title through PETS (Port Moresby Electronic Trading System).</p> <p>Under the operating rules for the PETS facility, this allows the PDI holder to obtain all the economic benefits attaching to the underlying securities without actually holding legal title to them. When PDIs are quoted on the PNGX, the underlying securities are regarded as having been quoted on the PNGX.</p>	Section 11.6
What are the Newmont PDIs?	<p>A Newmont PDI represents a unit of beneficial ownership in a Newmont Share that is held on trust for the Newmont PDI holder by PDN. PDN is appointed under the PNGX Business Rules to hold the Newmont Shares that underlie the PDIs as agent for the PDI holders.</p> <p>Newmont will issue the Newmont Shares to which the Newmont PDIs relate to PDN, who will hold legal title to those Newmont Shares on behalf of the holders of the Newmont PDI holders. PDN will issue the Newmont PDIs to relevant Scheme Shareholders in parallel.</p> <p>Newmont PDIs would be quoted and traded on the PNGX in the Papua New Guinean currency of Kina (PGK) and traded under the symbol "NEM".</p> <p>Newmont PDIs would not be quoted or traded on NYSE, TSX or ASX. This allows investors to trade interests in foreign securities on the PNGX by trading the relevant PDIs.</p> <p>Newmont will apply for the listing of Newmont PDIs (over a certain number of Newmont Shares), which are currently expected to be available and trade on a similar timetable to the Newmont CDIs on ASX.</p>	Section 11.6
What are the differences between Newmont Shares and Newmont PDIs?	<p>Newmont Shares will be fully paid shares in Newmont, ranking equally in all respects with all other Newmont Shares then on issue. Newmont Shares will be listed and traded on NYSE in US dollars and TSX in Canadian dollars.</p> <p>Except for certain differences noted in section 11.6, a Newmont PDI will have rights that are economically equivalent to the rights attaching to a Newmont Share. Newmont PDIs would be quoted and traded on the PNGX in the Papua New Guinean currency of Kina (PGK) and traded under the symbol "NEM".</p> <p>A holder of Newmont PDIs can, however, elect at any time to convert those Newmont PDIs to an equivalent number of Newmont Shares (via a process referred to as "transmuting" Newmont PDIs to Newmont Shares).</p> <p>A holder of Newmont PDIs will not be a registered Newmont Stockholder. Instead, Newmont Shares represented by Newmont PDIs will be held in the name of PDN, a Subsidiary of the PNGX. A Newmont PDI holder can direct PDN to vote the Newmont Shares represented by its Newmont PDIs in accordance with the Newmont PDI holder's directions.</p> <p>Further details on the difference between Newmont Shares and Newmont PDIs are set out in Section 11.6.</p>	Section 11.6
What are the risks relating to Newmont PDIs?	<p>There are several risks associated with Newmont Shares and Newmont PDIs including:</p> <ul style="list-style-type: none"> – the market for Newmont PDIs may be less liquid than the market for Newmont Shares; – the price of Newmont PDIs will be subject to, and reflect movements in, the Newmont Share price and the PGK:USD exchange rate price; and – the market price and volume of Newmont Shares may be subject to significant fluctuations. <p>Further details on the risks related to Newmont Shares and Newmont PDIs are set out in section 11.6.</p>	Section 11.6
Can I convert my Newmont PDIs into Newmont Shares?	<p>Newmont PDIs can be transmuted into Newmont Shares and vice versa at any time following the Implementation Date, by contacting the Newmont PDI registry or Newmont Share Registry (as applicable).</p>	Section 11.6
Who is an Ineligible Foreign Shareholder?	<p>Ineligible Foreign Shareholders are Newcrest Shareholders whose address shown in the Newcrest Share Register at the Scheme Record Date is in a place outside Australia and its external territories, Canada, New Zealand, PNG, the United Kingdom, the United States, the European Union (excluding Austria), Guernsey, Hong Kong, Japan, Norway, Singapore, South Korea, Switzerland, the United Arab Emirates, the Isle of Man and Bermuda.</p>	Section 4.3

Question	Answer	More information
Overview of the Scheme Consideration continued		
What will Ineligible Foreign Shareholders receive under the Scheme?	<p>If you are an Ineligible Foreign Shareholder, you will not receive Newmont Securities. Instead, you will receive your pro rata share of the Net Cash Proceeds. Further information is in section 11.5.</p> <p>It is the responsibility of Newcrest Shareholders to determine their entitlements prior to trading in any Newmont Securities (including during any deferred settlement trading period) to avoid the risk of selling Newmont Securities they do not own. Newcrest Shareholders selling Newmont Securities before they receive confirmation of their entitlement do so at their own risk.</p>	Sections 4.3 and 11.5
How will Newcrest ADS Holders be treated under the Scheme?	<p>ADSs representing Newcrest Shares are traded in the United States. Each Newcrest ADS represents one Newcrest Share.</p> <p>Subject to the terms of the Deposit Agreement, the Depositary will fix a voting record date in respect of the Scheme Meeting. The Depositary will mail to Newcrest ADS Holders that are registered on the Depositary's books a voting instruction card containing (i) a notice of meeting and solicitation of consent or proxy, (ii) a statement that the Newcrest ADS Holders at the close of business on the record date set by the Depositary in respect of the Scheme Meeting will be entitled, subject to any applicable law, the provisions of the Deposit Agreement and Newcrest's constitutional documents, to instruct the Depositary as to the exercise of the voting rights pertaining to the amount of Newcrest Shares represented by their Newcrest ADSs and (iii) information on where this Scheme Booklet can be accessed and how to request a paper copy of it. Upon the timely receipt of voting instructions of a registered Newcrest ADS Holder in the manner specified by the Depositary, the Depositary will endeavour, insofar as practicable and permitted under applicable law, the provisions of the Deposit Agreement and Newcrest's constitutional documents, to vote, or cause the custodian for the Depositary to vote, the amount of Newcrest Shares (in person or by proxy) represented by that holder's Newcrest ADSs at the Scheme Meeting in accordance with such voting instructions.</p> <p>Registered Newcrest ADS Holders should contact the Depositary for any additional information. Persons holding Newcrest ADSs through banks, brokers, nominees or other securities intermediaries should contact such banks, brokers, nominees or other securities intermediaries for any additional information.</p> <p>If the Scheme is implemented, all Newcrest Shares, including those underlying Newcrest ADSs will automatically be transferred to Newmont Overseas in exchange for the Scheme Consideration. In connection with these arrangements, Newcrest has instructed the Depositary to deliver the Newmont Shares directly to Newcrest ADS Holders, in proportion to the number of Newcrest ADSs held by them, upon surrenders by them of their Newcrest ADSs.</p>	Section 11.7
Will I have to pay brokerage?	You will not have to pay brokerage on the transfer of your Newcrest Shares to Newmont Overseas under the Scheme.	N/A
What are the taxation implications of the Scheme?	<p>If the Scheme becomes Effective, there will be tax consequences for Newcrest Shareholders which may include tax being payable on any gain on disposal of their Newcrest Shares.</p> <p>The taxation implications of the Scheme will depend on your particular circumstances.</p> <p>Section 9 provides a general description of certain Australian, United Kingdom and United States taxation consequences for Scheme Shareholders.</p> <p>You should seek independent professional tax advice with respect to your particular circumstances.</p> <p>Newcrest has applied to the ATO requesting a Class Ruling to confirm the key taxation implications of the Scheme and any Special Dividend.</p> <p>The Class Ruling has not been finalised as at the date of this Scheme Booklet. The Class Ruling is not expected to be issued by the ATO until after the Implementation Date. However, Newcrest expects that the ATO will provide a draft of the Class Ruling prior to the Scheme Meeting.</p> <p>When the final Class Ruling is published by the ATO, it will be available on the ATO's website at www.ato.gov.au.</p>	Section 9

2. Frequently asked questions

Question	Answer	More information
Dividends		
What is the Special Dividend?	<p>Newcrest expects to pay a franked Special Dividend of \$1.10 per Newcrest Share held on the Special Dividend Record Date (currently expected to be 7.00pm (Melbourne time) on Thursday, 19 October 2023), subject to the Scheme becoming Effective.³³</p> <p>The final decision on the amount of the Special Dividend will be made by the Newcrest Directors. This decision will be communicated to Newcrest Shareholders by way of an ASX, PNGX and TSX (via SEDAR) announcement before the Scheme Meeting.</p>	Letter from the Chairman of the Newcrest Board and section 4.4
Will the Special Dividend be franked?	<p>Under Australia's franking system, Australian companies can attach "franking credits" to their dividends, which represent Australian income tax paid on the company's profits. When Australian resident shareholders receive franked dividends, subject to meeting qualification requirements, they gross up the amount of the dividend by the amount of the credit but are entitled to a tax offset of the same amount to reduce their own income tax liability.</p> <p>A fully franked Special Dividend of \$1.10 per Newcrest Share would have approximately \$0.47 per Newcrest Share of franking credits attached (converted into Australian dollars at the spot rate on the relevant payment date).³³ Newcrest Shareholders may be entitled to a tax offset equal to the franking credits attached to the Special Dividend.</p> <p>The Special Dividend may be franked, provided that it does not cause Newcrest's franking account to be in deficit at any time, including (but not limited to) as at the Implementation Date, taking into account any reasonably expected tax refund in respect of any tax payments or instalments made for the period up to the Implementation Date.</p> <p>In assessing the value to them of a Special Dividend, Newcrest Shareholders should seek independent professional taxation advice as to whether or not the receipt of a Special Dividend, and any entitlement to franking credits attached to such dividend, is beneficial to them based on their own particular circumstances. In particular, Newcrest Shareholders should note that, depending on the timing of when they acquired their Newcrest Shares, there may be differences in the tax consequences for them.</p>	Sections 4.4 and 9
Am I eligible to receive the Special Dividend?	<p>Newcrest Shareholders will be entitled to receive the Special Dividend if they hold Newcrest Shares on the Special Dividend Record Date (currently expected to be 7.00pm (Melbourne time) on Thursday, 19 October 2023).</p> <p>Newcrest Shares will continue to trade on the ASX, PNGX and TSX after the Effective Date (currently expected to be Wednesday, 18 October 2023). If you sell your Newcrest Shares on or after the Special Dividend ex-date of Wednesday, 18 October 2023 up to close of trading on the ASX, PNGX and TSX on Thursday, 26 October 2023 such that you are no longer registered on the Newcrest Share Register on the Special Dividend Record Date (currently expected to be Thursday, 19 October 2023), you will not be entitled to receive the Special Dividend.</p>	Section 4.4
When will I receive the Special Dividend?	If the Special Dividend is declared and the Scheme becomes Effective, the Special Dividend will be paid on the Special Dividend Payment Date (currently expected to be Friday, 27 October 2023).	Section 4.4
Will I receive the Special Dividend if the Scheme does not become Effective?	If the Scheme does not become Effective, the Special Dividend will not be paid.	Section 4.4
Are ordinary dividends being paid?	<p>As permitted by the Scheme Implementation Deed, a final dividend of \$0.20 per Newcrest Share for the financial year ended 30 June 2023 will be paid on Monday, 18 September 2023. The record date for entitlement is Monday, 21 August 2023.</p> <p>In addition, under the terms of the Scheme Implementation Deed, Newcrest may, subject to complying with certain requirements, pay and declare a dividend of up to \$0.10 per Newcrest Share per quarterly period occurring after 30 June 2023 if the Scheme has not become Effective by Friday, 1 December 2023.</p>	Section 4.4

33. The franking of the Special Dividend amount is subject to change based on timing of implementation of the Scheme, business performance, finalisation of tax compliance matters relevant to the Newcrest Australian tax consolidated group, foreign exchange movements and an ATO Class Ruling. See sections 9.1(e) and 9.1(g)(2) for further information.

2. Frequently asked questions



Question	Answer	More information
Implementation of the Scheme		
Are there any conditions to the Scheme?	<p>The Scheme is subject to a number of Conditions Precedents set out in clause 3.1 of the Scheme Implementation Deed. These are set out in further detail in section 11.4(b).</p> <p>As at the date of this Scheme Booklet, the following Conditions Precedent remain outstanding:</p> <ul style="list-style-type: none"> – certain regulatory approvals, including FIRB approval and competition approvals; – Newmont Stockholder approval; – Newcrest Shareholder approval; – ASX Quotation and NYSE listing; – ATO Class Ruling; and – other customary conditions. <p>Newcrest and Newmont are engaging with the relevant regulatory authorities in relation to these approvals.</p>	Section 11.4(b)
What is required for the Scheme to become Effective?	<p>The Scheme will become Effective if:</p> <ul style="list-style-type: none"> – the Scheme is approved by the Requisite Majorities of Newcrest Shareholders at the Scheme Meeting to be held on Friday, 13 October 2023; – the Court approves the Scheme at the Second Court Hearing and the Court order is lodged with ASIC; and – all of the other Conditions Precedent to the Scheme are satisfied or waived (where capable of waiver). 	N/A
Can the Scheme be terminated?	<p>The Scheme Implementation Deed may be terminated in certain circumstances. If the Scheme Implementation Deed is terminated, the Scheme will not proceed.</p>	Section 11.4(h)
When and where will the Scheme Meeting be held?	<p>The Scheme Meeting will be held at 10.30am (Melbourne time) on Friday, 13 October 2023.</p> <p>The Scheme Meeting will be held:</p> <ul style="list-style-type: none"> – in person at the RACV City Club, 501 Bourke Street, Melbourne, Victoria 3000; and – online via the online meeting platform at https://meetings.linkgroup.com/NCMScheme 	Section 3 and Annexure 5
What will Newcrest Shareholders be asked to vote on at the Scheme Meeting?	<p>At the Scheme Meeting, Newcrest Shareholders will be asked to vote on whether to approve the Scheme.</p>	Annexure 5
What is the Newcrest Shareholder approval threshold for the Scheme?	<p>In order to become Effective, the Scheme must be approved by the Requisite Majorities, being:</p> <ul style="list-style-type: none"> – a majority in number (more than 50%) of Newcrest Shareholders present and voting at the Scheme Meeting (either in person or by proxy, attorney or, in the case of corporate Newcrest Shareholders, body corporate representative); and – at least 75% of the total number of votes cast on the Scheme Resolution at the Scheme Meeting by Newcrest Shareholders present and voting (either in person or by proxy, attorney or, in the case of corporate Newcrest Shareholders, body corporate representative). <p>The Court has the power to dispense with the first requirement.</p> <p>Even if the Scheme is approved by the Requisite Majorities of Newcrest Shareholders at the Scheme Meeting, the Scheme is still subject to the approval of the Court.</p>	Section 4.6(a)
Am I entitled to vote at the Scheme Meeting?	<p>If you are registered as a Newcrest Shareholder on the Newcrest Share Register as at 7.00pm (Melbourne time) on Wednesday, 11 October 2023, you will be entitled to attend and vote at the Scheme Meeting.</p>	Annexure 5

2. Frequently asked questions

Question	Answer	More information
Implementation of the Scheme continued		
How do I vote?	<p>You can vote:</p> <ul style="list-style-type: none"> – in person, by attending the Scheme Meeting held at the RACV City Club, 501 Bourke Street, Melbourne, Victoria 3000; – online, by participating and voting via the online meeting platform at https://meetings.linkgroup.com/NCMSHEME; – by casting a direct vote either online at https://investorcentre.linkgroup.com or by submitting a Proxy and Voting Form; or – by appointing a proxy, attorney or a corporate representative (if you are a body corporate), to attend the Scheme Meeting (in person or online) and vote on your behalf. <p>Proxy appointments and direct votes must be received by 10.30am (Melbourne time) on Wednesday, 11 October 2023 (for those holding Newcrest Shares on the Canadian Register, your equivalent Eastern Time deadline is 7.30pm on Tuesday, 10 October 2023). To appoint a proxy online, you will need your securityholder reference number (SRN) or holder identification number (HIN) and the postcode for your shareholding.</p>	Section 3 and Annexure 5
Is voting compulsory?	Voting is not compulsory. However, your vote will be important in determining whether the Scheme will proceed, as only those votes cast by Newcrest Shareholders on the Scheme will be counted in determining whether the Scheme has been approved by Requisite Majorities of Newcrest Shareholders.	Section 3
What happens to my Newcrest Shares if I do not vote, or if I vote against the Scheme, and the Scheme becomes Effective and is implemented?	<p>If you do not vote, or vote against the Scheme, and the Scheme becomes Effective and is implemented, any Scheme Shares held by you on the Scheme Record Date (currently expected to be 7.00pm (Melbourne time) on Monday, 30 October 2023) will be transferred to Newmont Overseas and you will receive the Scheme Consideration (unless you are an Ineligible Foreign Shareholder), despite not having voted or having voted against the Scheme.</p> <p>Newcrest Shareholders who are Ineligible Foreign Shareholders will not receive Newmont Securities. Instead, they will receive their pro rata share of the Net Cash Proceeds.</p>	Sections 4.3, 4.6(a) and 11.5
Can I sell my Newcrest Shares now?	<p>Newcrest Shares will continue to trade on the ASX, PNGX and TSX after the Effective Date (currently expected to be Wednesday, 18 October 2023).</p> <p>Newcrest intends to apply to the ASX, PNGX and TSX for Newcrest Shares to be suspended from trading on the ASX, PNGX and TSX from close of trading on Thursday, 26 October 2023. You can sell your Newcrest Shares on market at any time before this date at the then prevailing market price, but you will not be able to sell your Newcrest Shares on market after this date.</p> <p>If you sell your Newcrest Shares on market:</p> <ul style="list-style-type: none"> – on or after the Special Dividend ex-date of Wednesday, 18 October 2023 such that you are no longer registered on the Newcrest Share Register on the Special Dividend Record Date (currently expected to be Thursday, 19 October 2023), you will not be entitled to receive the Special Dividend; or – such that you are no longer registered on the Newcrest Share Register on the Scheme Record Date (currently expected to be (Monday, 30 October 2023), you will not be entitled to receive the Scheme Consideration. <p>If you sell your Newcrest Shares on or after the Special Dividend ex-date of Wednesday, 18 October 2023 up to close of trading on the ASX, PNGX and TSX on Thursday, 26 October 2023 such that you are registered on the Newcrest Share Register on the Special Dividend Record Date but will cease to be registered on the Newcrest Share Register on the Scheme Record Date, you will only receive the Special Dividend and will not receive the Scheme Consideration.</p> <p>If you sell your Newcrest Shares on market, you may pay brokerage on the sale, you will not receive the Scheme Consideration and there may be different tax consequences compared to those that would arise if you retain those shares until the Scheme is implemented.</p> <p>Newcrest Shareholders who hold their Newcrest Shares on the Canadian Register will not be able to trade their Newcrest Shares on TSX between Friday, 27 October 2023 (Eastern Time) and Sunday, 5 November 2023 (Eastern Time) and the first opportunity for these shareholders (other than Ineligible Foreign Shareholders) to trade Newmont Shares on TSX is on Monday, 6 November 2023 (Eastern Time).</p>	Sections 4.4, 4.6(d) and 4.6(e)
When will the results of the Scheme Meeting be known?	The results of the Scheme Meeting are expected to be available shortly after the conclusion of the Scheme Meeting and will be announced to the ASX (www.asx.com.au), PNGX (www.pngx.com.pg) and TSX (via SEDAR) (www.sedar.com) once available.	N/A

2. Frequently asked questions



Question	Answer	More information
Profile of the Merged Group		
What is the Merged Group?	<p>If the Scheme is implemented, Newmont will become the parent company of the Merged Group and Newcrest will become a wholly owned indirect Subsidiary of Newmont.</p> <p>Further information on the Merged Group is set out in section 7, including details on the expected profile of the group, expected synergies from the Scheme and Newmont's intentions for the Merged Group.</p>	Section 7
Who will the directors be?	<p>It is expected that each of the existing Newmont Directors will continue as directors following implementation of the Scheme.</p> <p>If the Scheme is implemented, Newmont will invite two current Newcrest Directors to join the Newmont Board on similar terms as Newmont's existing non-executive directors as set out in section 6.8.</p>	Section 7.4(a)
Who will senior management be?	<p>It is expected that the existing members of Newmont's senior leadership team will continue following implementation of the Scheme. See section 6.9 for further details on Newmont's senior management.</p>	Section 7.4(b)
What are Newmont's intentions regarding Newcrest and the Merged Group?	<p>Newmont intends to operate Newcrest's operations in a similar manner as they are currently operating, while focusing on the realisation of expected synergies for the Merged Group. Newmont has and will continue to undertake a review of the Merged Group's operations from a strategic, financial and commercial operating perspective to identify and implement improvements and to optimise the Merged Group.</p> <p>Newmont's intentions in relation to the Merged Group are set out in section 7.3.</p>	Section 7.3
What are the key risks of the Merged Group?	<p>Newcrest Shareholders should be aware that there are a number of risks, both general and specific, relating to the business and operations of the Merged Group and associated with the Scheme.</p> <p>Some of the key risks relating to the business and operations of the Merged Group and associated with implementation of the Scheme are detailed in section 8.2.</p>	Section 8.2
What is Newmont's dividend framework?	<p>Newmont's non-binding dividend framework is set out in sections 6.7 and 7.3(d).</p>	Sections 6.7 and 7.3(d)
What voting rights will Newcrest Shareholders have in the Merged Group?	<p>The Scheme Consideration comprises Newmont Securities. Accordingly, Newcrest Shareholders on the Scheme Record Date (other than Ineligible Foreign Shareholders) will receive Newmont Securities, depending on which register they hold their Newcrest Shares (see section 4.2 for further details).</p> <p>Holders of Newmont Securities will have the right to one vote per Newmont Security.</p>	Sections 7.8 and 10
Further information		
What if I have further questions about the Scheme?	<p>For further information, please contact the Newcrest Shareholder Information Line on 1800 425 578 (within Australia) or +61 1800 425 578 (outside Australia), between 8.30am and 7.30pm (Melbourne time), Monday to Friday (excluding public holidays).</p> <p>If you are in doubt about anything in this Scheme Booklet, please contact your legal, financial, tax or other professional adviser.</p>	N/A

3. What should you do?

3.1 Step 1: Read this Scheme Booklet

You should carefully read this Scheme Booklet in its entirety before deciding whether to vote in favour of the Scheme.

If you have any questions, please contact the Newcrest Shareholder Information Line on 1800 425 578 (within Australia) or +61 1800 425 578 (outside Australia), between 8.30am and 7.30pm (Melbourne time), Monday to Friday (excluding public holidays).

If you are in any doubt as to what you should do, please consult your legal, financial, tax or other professional adviser.

3.2 Step 2: Vote on the Scheme

a) Your vote is important

Your vote is important because the Scheme can only proceed if it is approved by Newcrest Shareholders at the Scheme Meeting.

b) Are you entitled to vote?

If you are registered on the Newcrest Share Register at 7.00pm (Melbourne time), Wednesday, 11 October 2023, you will be entitled to vote on the Scheme.

c) How may you vote?

1) Voting and proxy appointment by Newcrest Shareholders on the Australian Register and PNG Register

Newcrest Shareholders entitled to vote at the Scheme Meeting may vote:

- **in person**, by attending the Scheme Meeting held at the RACV City Club, 501 Bourke Street, Melbourne, Victoria 3000;
 - **online**, by participating and voting online at meetings.linkgroup.com/NCMSHEME. To vote online, Newcrest Shareholders will need their SRN/HIN and their postcode or country of residence (if outside Australia);
 - **by proxy**, by lodging a proxy form in one of the following ways:
 - > **online** at <https://investorcentre.linkgroup.com> or on their smartphone using the QR code on the Proxy and Voting Form. To do so Newcrest Shareholders will need their SRN/HIN and the postcode for their shareholding);
 - > **by post** in the reply-paid envelope provided to Newcrest Mining Limited C/- Locked Bag A14 Sydney South NSW 1235 Australia;
 - > **by hand delivery** during business hours to the Newcrest Share Registry at Link Market Services Limited at either Parramatta Square, Level 22, Tower 6, 10 Darcy Street, Parramatta NSW 2150 or Level 12, 680 George Street, Sydney NSW 2000; or
 - > **by fax** to the Newcrest Share Registry +61 2 9287 0309.
- Proxyholders will be emailed their proxy code by the Newcrest Share Registry 24 hours before the commencement of the Scheme Meeting. Newcrest Shareholders on the PNG register should refer to the Proxy and Voting Form for PNG specific contact information for lodgement by post, hand delivery, fax or email;
- **by casting a direct vote**, prior to the Scheme Meeting either online at <https://investorcentre.linkgroup.com> or by submitting a Proxy and Voting Form in the manner stated on the form and described above;
 - **by attorney**, by appointing an attorney to attend and vote at the Scheme Meeting on your behalf. An attorney may, but need not, be a Newcrest Shareholder. An attorney may not vote at the Scheme Meeting unless the instrument appointing the attorney, and the authority under which the instrument is signed or a certified copy of the authority, are received by Newcrest before the Scheme Meeting (unless it has been previously given to Newcrest). A validly appointed attorney wishing to attend and vote at the Scheme Meeting via the online platform will require the appointing Newcrest Shareholder's name and postcode and the SNR/HIN of the shareholding in order to access the online platform; or
 - **by corporate representative**, if you are a body corporate, by appointing a corporate representative to attend and vote at the Scheme Meeting on behalf of that Newcrest Shareholder. The corporate representative must ensure that Newcrest has received a certificate of appointment, together with any authority under which the appointment is signed, prior to the Scheme Meeting (unless it has previously been given to Newcrest). A form of notice of appointment can be obtained from Link Market Services by calling 1300 554 474 within Australia or +61 1300 554 474 outside Australia (between 8.30am and 7.30pm (Melbourne time)) or downloaded from www.linkmarketservices.com.au. A validly appointed corporate representative wishing to attend and vote at the Scheme Meeting via the online platform will require the appointing Newcrest Shareholder's name, the SRN/HIN of the shareholding, proxy code and postcode or country of residence (if outside Australia) in order to access the online platform.

Proxy appointments and direct votes must be received by 10.30am (Melbourne time) on Wednesday, 11 October 2023 (for those holding Newcrest Shares on the Canadian Register, your equivalent Eastern Time deadline is 7.30pm on Tuesday, 10 October 2023).



3.2 Step 2: Vote on the Scheme *continued*

2) Voting and proxy appointment by Newcrest Shareholders on the Canadian Register

Registered holders on the Canadian Register

You are a registered shareholder if your name appears on your share certificate. If your Newcrest Shares are held on the Canadian register, your Notice of Access letter was accompanied by a Proxy and Voting Form. Newcrest Shareholders who are registered shareholders on the Canadian Register can vote:

- **in person**, by attending the Scheme Meeting held at the RACV City Club, 501 Bourke Street, Melbourne, Victoria 3000;
- **online** at www.meeting-vote.com by following the on-screen instructions or on their smartphone using the QR code on the Proxy and Voting Form;
- **by proxy**, by lodging a Proxy and Voting Form in one of the following ways:
 - > by scanning and emailing the form to proxyvote@tmx.com; or
 - > by mailing the form to TSX Trust Company, Attention: Proxy Department, P.O. Box 721, Agincourt, ON M1S 0A1.

TSX Trust Company must receive your voting instructions by 7:30pm (Eastern Time) on Tuesday, 10 October 2023.

Non-registered holders on the Canadian Register

You are a non-registered shareholder if your Newcrest Shares are registered under the name of an intermediary or other financial institution, or held in the name of a clearing agency (such as CDS or Depository Trust Company) that their intermediary deals with, and you are the beneficial owner.

If you are the beneficial owner of the Newcrest Shares, you have the right to instruct your intermediary how to vote your Newcrest Shares. Your Notice of Access letter includes a Voting Instruction Form. To instruct your intermediary how to cast your votes, please follow the instructions on the Voting Instruction Form.

Further details on how to vote are set out in Annexure 5.

3) Newcrest ADS Holders

Newcrest ADS Holders should refer to section 11.7 for information on voting.

4. Overview of the Scheme

4.1 Background to the Scheme

On 15 May 2023, Newcrest announced that it had entered into a Scheme Implementation Deed with Newmont and Newmont Overseas, under which the parties agreed to implement the Scheme between Newcrest and its shareholders.

A full copy of the Scheme Implementation Deed was announced to the ASX (www.asx.com.au), PNGX (www.pngx.com.pg) and TSX (via SEDAR) (www.sedar.com) and published on Newcrest's website (www.newcrest.com).

If the Scheme is approved by Newcrest Shareholders at the Scheme Meeting and by the Court, and if all Conditions Precedent are satisfied or waived (where capable of waiver), Newcrest will become a wholly owned indirect Subsidiary of Newmont, will be delisted from the ASX, PNGX and TSX and Scheme Shareholders will receive the Scheme Consideration. Newcrest Shareholders who are Ineligible Foreign Shareholders, will not receive Newmont Securities. Instead, they will receive their pro rata share of the Net Cash Proceeds.

If the Scheme is not approved, the Scheme will not be implemented, Scheme Shareholders will not receive the Scheme Consideration and Newcrest will continue as a standalone entity listed on the ASX, PNGX and TSX.

Newcrest and Newmont, acting together, reserve the right (but have no obligation) to agree to amend the Scheme, including to vary the type of Newmont Security that would comprise the Scheme Consideration to which Newcrest Shareholders (who are not Ineligible Foreign Shareholders) are entitled.

4.2 Overview of the Scheme Consideration

a) Overview of the Scheme Consideration

If the Scheme is implemented, Newcrest Shareholders will be entitled to receive the Scheme Consideration of 0.400 Newmont Securities for each Newcrest Share held on the Scheme Record Date (currently expected to be 7:00pm (Melbourne time) on Monday, 30 October 2023).

Under the Scheme, Newcrest Shareholders (other than Ineligible Foreign Shareholders) who hold their Newcrest Shares on the:

- Australian Register will receive Newmont CDIs;
- PNG Register will receive Newmont PDIs; and
- Canadian Register will receive Newmont Shares.

Newcrest Shareholders who are Ineligible Foreign Shareholders, will not receive Newmont Securities. Instead, they will receive their pro rata share of the Net Cash Proceeds.

Newcrest Shareholders can reposition their Newcrest Shares between the Australian Register, PNG Register and Canadian Register on or before Thursday, 26 October 2023. This includes a Newcrest Shareholder who holds their Newcrest Shares on the Canadian Register repositioning that holding to the Australian Register or PNG Register to allow that shareholder (provided they are not an Ineligible Foreign Shareholder) to be entitled to receive Newmont CDIs or Newmont PDIs and participate in deferred settlement trading on the ASX and PNGX between Friday, 27 October 2023 and Monday, 6 November 2023 (see sections 7.8(f) and 11.6(b)(1)).

Following implementation of the Scheme, Newcrest Shareholders can transmute Newmont CDIs and Newmont PDIs into Newmont Shares and vice versa. Further details on this process are set out in sections 7.8(c) (in respect of Newmont CDIs) and 11.6 (in respect of section Newmont PDIs).

b) Newmont Securities

Scheme Shareholders (other than Ineligible Foreign Shareholders) will receive the Scheme Consideration of Newmont Securities.

Newmont Shares

Newmont Shares will be fully paid shares of common stock of Newmont and will be listed and traded on NYSE in US dollars and TSX in Canadian dollars.

Newmont CDIs

A CDI, or CHESS depository interest, is a type of depository receipt that allows investors in foreign companies such as Newmont to obtain all the economic benefit of owning securities in the foreign company (such as Newmont Shares) without holding legal title to the securities.

The underlying securities represented by a CDI are registered in the name of the depository nominee as legal owner, or held in the form of beneficial ownership but, under the operating rules for the CHESS facility, all of the economic benefits attaching to the underlying securities accrue to the CDI holder. When CDIs are quoted on the ASX, the underlying securities are regarded as having been quoted on the ASX.

Currently, CDN is the only depository nominee offering CDI services for ASX quoted securities. Newmont CDIs will be quoted and traded on the ASX (ASX: NEM).

A description of the Newmont Shares and Newmont CDIs is set out in section 7.8.

Newmont PDIs

See section 11.6 for further information on Newmont PDIs.



4.2 Overview of the Scheme Consideration *continued*

c) Eligibility and limitations

A Newcrest Shareholder is only entitled to receive the Scheme Consideration if they hold Newcrest Shares on the Scheme Record Date (currently expected to be 7.00pm on Monday, 30 October 2023).

Newcrest Shareholders who are Ineligible Foreign Shareholders will not receive Newmont Securities. Instead, they will receive their pro rata share of the Net Cash Proceeds of the sale of the Newmont Shares that they would otherwise have been entitled to receive (see section 4.3).

d) Fractional entitlements

Where the calculation of the Scheme Consideration to be issued to a particular Scheme Shareholder would result in the Scheme Shareholder becoming entitled to a fraction of a Newmont Security, then the fractional entitlement will be rounded to the nearest whole number of Newmont Securities, with any such fractional entitlement of:

- less than 0.5 being rounded down to the nearest whole number; and
- 0.5 or more being rounded up to the nearest whole number.

4.3 Ineligible Foreign Shareholders

Ineligible Foreign Shareholders are Newcrest Shareholders whose address shown in the Newcrest Share Register at the Scheme Record Date is in a place outside Australia and its external territories, Canada, New Zealand, PNG, the United Kingdom, the United States, the European Union (excluding Austria), Guernsey, Hong Kong, Japan, Norway, Singapore, South Korea, Switzerland, the United Arab Emirates, the Isle of Man and Bermuda.

Newcrest Shareholders who are Ineligible Foreign Shareholders will not receive Newmont Securities. Instead, they will receive their pro rata share of the Net Cash Proceeds of the sale of the Newmont Shares which they would otherwise have received under the Scheme. Further information is in section 11.5.

It is the responsibility of Newcrest Shareholders to determine their entitlements prior to trading in any Newmont Securities (including during any deferred settlement trading period) to avoid the risk of selling Newmont Securities they do not own. Newcrest Shareholders selling Newmont Securities CDIs before they receive confirmation of their entitlement do so at their own risk.

4.4 Dividends

Newcrest expects to pay a franked Special Dividend of \$1.10 per Newcrest Share held on the Special Dividend Record Date (currently expected to be 7.00pm (Melbourne time) on Thursday, 19 October 2023), subject to the Scheme becoming Effective.³⁴

Newcrest Shares will continue to trade on the ASX, PNGX and TSX after the Effective Date (currently expected to be Wednesday, 18 October 2023). Newcrest Shareholders who sell their Newcrest Shares on market on or after the Special Dividend ex-date of Wednesday, 18 October 2023 such that they are no longer registered on the Newcrest Share Register on the Special Dividend Record Date (currently expected to be Thursday, 19 October 2023) will not be entitled to receive the Special Dividend.

The final decision on the amount of the Special Dividend will be made by the Newcrest Directors. This decision will be communicated to Newcrest Shareholders by way of an ASX, PNGX and TSX (via SEDAR) announcement before the Scheme Meeting.

If the Special Dividend is declared and the Scheme becomes Effective, the Special Dividend will be paid on the Special Dividend Payment Date (currently expected to be Friday, 27 October 2023). If the Scheme does not become Effective, the Special Dividend will not be paid.

A fully franked Special Dividend of \$1.10 per Newcrest Share would have approximately \$0.47 per Newcrest Share of franking credits attached (converted into Australian dollars at the spot rate on the relevant payment date).³⁴ Newcrest Shareholders may be entitled to a tax offset equal to the franking credits attached to the Special Dividend (refer to section 9 for further details). The Special Dividend may be franked, provided that it does not cause Newcrest's franking account to be in deficit at any time, including (but not limited to) as at the Implementation Date, taking into account any reasonably expected tax refund in respect of any tax payments or instalments made for the period up to the Implementation Date.

In assessing the value to them of a Special Dividend, Newcrest Shareholders should seek independent professional tax advice as to whether or not the receipt of a Special Dividend and any entitlement to franking credits attached to the Special Dividend is beneficial to them based on their own particular circumstances. In particular, Newcrest Shareholders should note that, depending on the timing of when they acquired their Newcrest Shares, there may be differences in the tax consequences for them. Refer to section 9 for further details.

34. The franking of the Special Dividend amount is subject to change based on timing of implementation of the Scheme, business performance, finalisation of tax compliance matters relevant to the Newcrest Australian tax consolidated group, foreign exchange movements and an ATO Class Ruling. See sections 91(e) and 91(g)(2) for further information.

4. Overview of the Scheme

4.4 Dividends *continued*

As permitted by the Scheme Implementation Deed, a final dividend of \$0.20 per Newcrest Share for the financial year ended 30 June 2023 will be paid on Monday, 18 September 2023. The record date for entitlement is Monday, 21 August 2023.

In addition, under the terms of the Scheme Implementation Deed, Newcrest may, subject to complying with certain requirements, pay and declare a dividend of up to \$0.10 per Newcrest Share per quarterly period occurring after 30 June 2023 if the Scheme has not become Effective by Friday, 1 December 2023.

4.5 Exempt Issuer Listing on PNGX and Newmont PDIs

Newmont intends to apply for admission to the Official List of PNGX as an Exempt Issuer, subject to customary conditions and the Scheme becoming Effective.

Scheme Shareholders, other than Ineligible Foreign Shareholders, who hold their Scheme Shares on the PNG Register will receive Newmont PDIs as Scheme Consideration.

See section 11.6 for further information.

4.6 Key steps in the Scheme

a) Scheme Meeting and Scheme approval requirements

1) Date of Scheme Meeting

The Court has ordered Newcrest to convene the Scheme Meeting at 10.30am (Melbourne time) on Friday, 13 October 2023 at which Newcrest Shareholders will be asked to approve the Scheme.

The terms of the Scheme Resolution to be considered by Newcrest Shareholders at the Scheme Meeting are set out in the Notice of Scheme Meeting in Annexure 5.

2) Scheme approval

The Scheme will only become Effective and be implemented if:

- it is approved by the Requisite Majorities of Newcrest Shareholders at the Scheme Meeting;
- it is approved by the Court at the Second Court Hearing; and
- the Conditions Precedent to the Scheme outlined in section 11.4(b) are satisfied or waived (where capable of waiver).

The Requisite Majorities to approve the Scheme are:

- a majority in number (more than 50%) of Newcrest Shareholders present and voting at the Scheme Meeting (either in person, online or by proxy, attorney or, in the case of corporate Newcrest Shareholders, body corporate representative); and
- at least 75% of the total number of votes cast on the Scheme Resolution at the Scheme Meeting.

The Court has the power to dispense with the first requirement.

3) Entitlement to vote

Newcrest Shareholders who are registered on the Newcrest Share Register at 7.00pm (Melbourne time) on Wednesday, 11 October 2023 will be entitled to vote on the Scheme. Further details on how to attend and vote at the Scheme Meeting are set out in the Notice of Scheme Meeting included in Annexure 5.

Voting is not compulsory. However, the Newcrest Directors unanimously recommend that Newcrest Shareholders vote in favour of the Scheme, in the absence of a Superior Proposal and subject to the Independent Expert continuing to conclude that the Scheme is in the best interests of Newcrest Shareholders.

You should be aware that even if you do not vote, or vote against the Scheme, the Scheme may still be implemented if it is approved by Newcrest Shareholders and the Court. If this occurs, your Newcrest Shares will be transferred to Newmont Overseas and you will receive the Scheme Consideration even though you did not vote on, or voted against, the Scheme (unless you are an Ineligible Foreign Shareholder).

The results of the Scheme Meeting will be available as soon as possible after the conclusion of the Scheme Meeting and will be announced to the ASX (www.asx.com.au), PNGX (www.pngx.com.pg) and SEDAR (www.sedar.com) once available.

b) Court approval of the Scheme

In the event that:

- the Scheme is approved by the Requisite Majorities of Newcrest Shareholders at the Scheme Meeting; and
 - all other Conditions Precedent to the Scheme (except Court approval of the Scheme) have been satisfied or waived (where capable of waiver),
- then Newcrest will apply to the Court for orders approving the Scheme.

Each Newcrest Shareholder has the right to appear at the Second Court Hearing.

4.6 Key steps in the Scheme *continued*

c) Effective Date

If, at the Second Court Hearing, the Court approves the Scheme, Newcrest will lodge an office copy of the Court order from the Second Court Hearing approving the Scheme with ASIC. Once such Court orders are lodged with ASIC, the Scheme becomes Effective on the Effective Date (currently expected to be Wednesday, 18 October 2023). Newcrest will, on the Scheme becoming Effective, give notice of that event to the ASX, PNGX and TSX (via SEDAR).

d) Suspension from trading

Newcrest Shares will continue to trade on the ASX, PNGX and TSX after the Effective Date (currently expected to be Wednesday, 18 October 2023). Newcrest intends to apply to the ASX, PNGX and TSX for Newcrest Shares to be suspended from trading on the ASX, PNGX and TSX from close of trading on Thursday, 26 October 2023.

The TSX has granted permission for Newcrest Shares to trade on a T+1 basis during the course of trading on Thursday, 26 October 2023. Non-registered holders of Newcrest Shares on the Canadian Register should note that full restrictions will be imposed by each of CDS and the Depository Trust Company over Newcrest Shares on and from 4.30pm on Friday, 27 October 2023 (Eastern Time) such that there cannot be any trades or withdrawals prior to the Scheme Record Date. These holders should refer to the bulletins published by each of CDS and the Depository Trust Company for further details on trading limitations that may be imposed.

If you sell your Newcrest Shares on or after the Special Dividend ex-date of Wednesday, 18 October 2023 up to close of trading on the ASX, PNGX and TSX on Thursday, 26 October 2023 such that you are registered on the Newcrest Share Register on the Special Dividend Record Date but will cease to be registered on the Newcrest Share Register on the Scheme Record Date, you will only receive the Special Dividend and will not receive the Scheme Consideration.

Newcrest Shareholders who hold their Newcrest Shares on the Canadian Register will not be able to trade their Newcrest Shares on TSX between Friday, 27 October 2023 (Eastern Time) and Sunday, 5 November 2023 (Eastern Time) and the first opportunity for these shareholders (other than Ineligible Foreign Shareholders) to trade Newmont Shares on TSX is on Monday, 6 November 2023 (Eastern Time).

e) Scheme Record Date and entitlement to Scheme Consideration

Those Newcrest Shareholders who are registered on the Newcrest Share Register on the Scheme Record Date (currently expected to be 7.00pm (Melbourne time) on Monday, 30 October 2023) will be entitled to receive the Scheme Consideration in respect of the Newcrest Shares they hold at that time.

On the Scheme Record Date (currently expected to be 7.00pm (Melbourne time) on Monday, 30 October 2023), those Newcrest Shareholders on the:

- Australian Register will be entitled to receive Newmont CDIs in respect of the Newcrest Shares they hold at that time;
- PNG Register will be entitled to receive Newmont PDIs in respect of the Newcrest Shares they hold at that time; and
- Canadian Register will be entitled to receive Newmont Shares in respect of the Newcrest Shares they hold at that time.

1) Dealings on or prior to the Scheme Record Date

For the purposes of determining which Newcrest Shareholders are eligible to participate in the Scheme, dealings in Newcrest Shares will be recognised only if:

- in the case of dealings of the type to be effected using CHESS, the transferee is registered on the Newcrest Share Register as the holder of the relevant Newcrest Shares before the Scheme Record Date; and
- in all other cases, registrable transfer or transmission applications in respect of those dealings, or valid requests in respect of other alterations, are received by the Newcrest Share Registry before the Scheme Record Date (and the transferee remains registered as at the Scheme Record Date).

For the purposes of determining entitlements under the Scheme, Newcrest will not accept for registration or recognise any transfer or transmission applications in respect of Newcrest Shares received after the Scheme Record Date.

2) Dealings after the Scheme Record Date

For the purpose of determining entitlements to the Scheme Consideration, Newcrest must maintain the Newcrest Share Register in its form as at the Scheme Record Date until the Scheme Consideration has been issued to the Scheme Shareholders. The Newcrest Share Register in this form will solely determine entitlements to the Scheme Consideration.

After the Scheme Record Date:

- all statements of holding for Newcrest Shares (other than statements of holding in favour of Newmont) will cease to have effect as documents relating to title in respect of such Newcrest Shares; and
- each entry on the Newcrest Share Register (other than entries on the Newcrest Share Register in respect of Newmont) will cease to have effect except as evidence of entitlement to the Scheme Consideration in respect of the Newcrest Shares relating to that entry.

4. Overview of the Scheme

4.6 Key steps in the Scheme *continued*

f) Implementation Date

Scheme Shareholders (other than Ineligible Foreign Shareholders) will be issued the Scheme Consideration on the Implementation Date (currently expected to be Monday, 6 November 2023). Immediately after the Scheme Consideration is issued to Scheme Shareholders, the Scheme Shares will be transferred to Newmont Overseas.

After the Implementation Date, Newmont must send a holding statement, DRS statement or confirmation advice to each Scheme Shareholder (other than an Ineligible Foreign Shareholder) representing the number of Newmont Securities issued to the Scheme Shareholder pursuant to the Scheme.

g) Deed Poll

A Deed Poll has been entered into by Newmont and Newmont Overseas in favour of the Scheme Shareholders, to:

- provide, or procure the provision of, the Scheme Consideration to all Scheme Shareholders under the Scheme, subject to the Scheme becoming Effective; and
- undertake all other actions attributed to Newmont and Newmont Overseas under the Scheme.

A copy of the Deed Poll is included in Annexure 4.

4.7 Warranties by Scheme Shareholders

Under the terms of the Scheme, each Scheme Shareholder is taken to have warranted to Newcrest and Newmont Overseas, and appointed and authorised Newcrest as its attorney and agent to warrant to Newmont Overseas, on the Implementation Date, that:

- all their Newcrest Shares (including any rights and entitlements attaching to those shares) which are transferred under the Scheme will, at the date of transfer, be fully paid and free from all mortgages, charges, liens, encumbrances, pledges, security interests (including any 'security interests' within the meaning of section 51A of the Corporations Act) and interests of third parties of any kind, whether legal or otherwise, and restrictions on transfer of any kind;
- they have full power and capacity to transfer their Scheme Shares to Newmont Overseas together with any rights and entitlements attaching to those shares; and
- they have no existing right to be issued any Newcrest Shares, or any options, performance rights, securities or other instruments exercisable, or convertible, into Newcrest Shares.

4.8 Delisting of Newcrest

Newcrest will apply for the termination of the official quotation of Newcrest Shares on the ASX, PNGX and TSX and for Newcrest to be removed from the ASX, PNGX and TSX, each to occur on a date after the Implementation Date to be determined by Newmont.

4.9 Implications if the Scheme does not become Effective

If the Scheme does not become Effective:

- Newcrest Shareholders will continue to hold Newcrest Shares and will be exposed to general risks as well as risks specific to Newcrest, including those set out in section 8.4;
- Newcrest Shareholders will not receive the Scheme Consideration;
- Newcrest Shareholders will not receive the Special Dividend;
- a break fee of \$174,058,275 may be payable by Newcrest to Newmont under certain circumstances. Those circumstances do not include the failure by Newcrest Shareholders to approve the Scheme at the Scheme Meeting. Further information on the break fee is set out in section 11.4(f);
- a reverse break fee of \$374,766,240 may be payable by Newmont to Newcrest under certain circumstances. Further information on the reverse break fee is set out in section 11.4(g);
- third party costs and expenses actually incurred by any Newcrest Group Member during the period commencing 14 January 2023 until the Newmont Stockholder Meeting may be payable by Newmont to Newcrest if the Scheme Implementation Deed is terminated due to failure to obtain the Newmont Stockholder approval;
- Newcrest will continue as a standalone entity listed on the ASX, PNGX and TSX with management continuing to implement the business plan and financial and operating strategies it had in place prior to 15 May 2023, being the date Newcrest, Newmont and Newmont Overseas entered into the Scheme Implementation Deed; and
- the Newcrest Share price may fall in the near-term if the Scheme is not implemented and in the absence of a Superior Proposal.



5.1 Overview of Newcrest

Newcrest is a corporation registered in Victoria, Australia, and governed by the Corporations Act. Newcrest's shares are listed on the ASX, PNGX and TSX. Newcrest also has Newcrest ADSs issued by the Depositary and traded on the over-the-counter market in the United States.

As at 30 June 2023, Newcrest was one of the largest gold mining companies globally by production and the largest gold producer listed on the ASX by market capitalisation. In the year to 30 June 2023 Newcrest's operations produced 2.1 Moz of gold, 133.1 kt of copper at an AISC of \$1,093 per ounce, which includes outcomes resulting from Newcrest's 32% attributable share of Fruta Del Norte through its 32% equity interest in Lundin Gold. In addition to gold, Newcrest also produces copper, silver and molybdenum as by-products. As at the Last Practicable Date, Newcrest had a market capitalisation of A\$23.0 billion.

Newcrest's portfolio includes long life mines and a strong pipeline of brownfield and greenfield exploration projects. Newcrest has operations in Australia, PNG and Canada, interests in potential development projects in PNG, Australia and Fiji, an equity holding in a Canadian company with an operation in Ecuador, and undertakes exploration activities in Canada, Australia, the United States and Ecuador.

5.2 Newcrest operations and projects

a) Overview

Newcrest's mining operations currently comprise the following operating mines located in Australia, PNG and Canada:

- Cadia, 100% owned by Newcrest and located in central western NSW, Australia, including the Cadia East underground mine, which produces gold doré, copper-gold concentrate and molybdenum concentrate;
- Lihir, 100% owned by Newcrest and located on the island of Aniolum, PNG, comprising of an open pit mine, which produces gold doré;
- Telfer, 100% owned by Newcrest and located in WA, Australia, comprising open pit and underground mines which produce gold doré and copper-gold concentrate;
- Red Chris, located in British Columbia, Canada, currently comprising of an open pit mine which produces gold, copper and silver concentrate. Newcrest, through its wholly owned Subsidiary, Newcrest Red Chris Mining Limited, has a 70% interest in the Red Chris joint venture and is the operator of the mine, with the remaining 30% interest owned by a Subsidiary of Imperial Metals Corporation; and
- Brucejack, 100% owned by Newcrest and located in British Columbia, Canada, comprising of an underground mine which produces gold-silver doré and flotation concentrate.

In FY24, Newcrest is expected to produce between 2,000 koz and 2,300 koz of gold and between 120 kt and 140 kt of copper at an AISC of between \$2,200 million and \$2,600 million.³⁵

b) Cadia

Cadia is located 25 km from Orange, NSW. Cadia is one of the world's largest gold and copper mining operations with Ore Reserves of 17 Moz gold and 3.6 Mt copper, and Measured and Indicated Mineral Resources of 32 Moz gold and 7.2 Mt copper.³⁶

Cadia is 100% owned by Newcrest through its wholly owned Subsidiary, Cadia Holdings Pty Ltd. Cadia consists of six granted mining leases and five granted exploration licences.

The Cadia East mine is operating, and the Ridgeway mine is not operational but remains subject to maintenance requirements.

In November 2022, the PC1-2 feasibility study was approved to execution. PC1-2 is the next panel cave for execution at Cadia after PC2-3 and its development is expected to recover approximately 20% of Cadia's published Ore Reserves.

Mining and exploration activities are conducted year-round. Exploration activities completed by Newcrest in FY23 comprised of a strategic exploration target review of the Cadia tenement packages to support prioritisation of the exploration program moving forward in FY24.

Exploration activities remain focused on a number of deposit models including porphyry gold-copper, intrusion-related gold-base metal quartz-carbonate veins and breccias, replacement style magnetite/hematite-copper-gold skarns and distal reduced gold skarns.

In FY23, Cadia produced 597 koz of gold at an AISC of \$45 per ounce.

35. Newcrest provides this guidance, subject to market and operating conditions. Newcrest has determined, in consideration of the Scheme Implementation Deed and the upcoming Scheme Meeting, that guidance for the 12 months ending 30 June 2024 will be provided on a Newcrest Group-level basis. Newcrest has followed its standard Newcrest Group budget reporting process in preparing this guidance range based on Newcrest continuing on a standalone basis. If the Scheme is approved by Newcrest Shareholders and the other Conditions Precedent are satisfied or waived, Newmont will assume management control of Newcrest and the Newcrest Group level guidance set out below will not apply.

36. As at 30 June 2023. For tonnes and grade breakdown by confidence category refer to Table 5.5.7 for Ore Reserves and Table 5.5.1 for Mineral Resources in section 5.5.

5. Profile of the Newcrest Group

5.2 Newcrest operations and projects *continued*

c) Lihir

Lihir is located on Aniolam Island, approximately 900 km from Port Moresby, PNG. Lihir is one of the world's largest producing gold mines, with Ore Reserves of 22 Moz gold and Measured and Indicated Mineral Resources of 41 Moz gold.³⁷

Lihir is 100% owned by Newcrest's wholly owned Subsidiary, Lihir Gold Limited. Lihir consists of a granted special mining lease, two granted mining leases, one granted exploration licence, five granted leases for mining purposes, and three mining easements held in the name of Lihir Gold Limited. The total area under licence is approximately 263 km².

The Lihir area is situated on land held variously under customary, State of PNG and private ownership, including under State lease.

In January 2023, the phase 14A feasibility study was approved to full implementation. The study outlines an updated life of mine plan which is expected to deliver high grade gold production from an additional ore source which is well supported by recent geotechnical drilling.

In FY23 exploration activities were limited and included community liaison focused on potential FY24 activities. Newcrest remains actively focused on exploration within the Aniolam Island area.

In FY23, Lihir operations produced 670 koz of gold at an AISC of \$1,466 per ounce.

d) Telfer

Telfer is located 400 km from Port Hedland, WA and 45 km west of Havieron, and comprises the West Dome open pits and underground mines, with Ore Reserves of 2.4 Moz gold and 0.10 Mt copper, and Measured and Indicated Mineral Resources of 5.8 Moz gold and 0.49 Mt copper.³⁸ Telfer produces gold and copper via a large, dual train, comminution circuit followed by flotation and cyanide circuits, which produce gold doré and a copper-gold concentrate.

Telfer is strategically well positioned in the highly prospective Paterson Province, with its existing infrastructure and processing capacity providing potential future benefits to the nearby Havieron and Newcrest's other exploration projects in the region.

Telfer is 100% owned by Newcrest, with 30% being held through its wholly owned Subsidiary, Newcrest Operations Limited. Newcrest holds 30 mining leases at the Telfer operation.

In November 2022, the West Dome Stage 8 cutback was approved, underpinning the continuity of Telfer with the mine now expected to extend operations into early FY25.³⁹

In FY23, Telfer produced 349 koz of gold at an AISC of \$1,633 per ounce.

e) Brucejack

Newcrest acquired the Brucejack operation by its acquisition of Pretium on 9 March 2022.

The Brucejack mine is located in the highly prospective Golden Triangle region of British Columbia, Canada, approximately 140 km away from Newcrest's majority-owned and operated Red Chris mine with Ore Reserves of 3.7 Moz gold and Indicated Mineral Resources of 8.2 Moz gold.³⁷ The Brucejack property consists of four mining leases and 342 mineral claims.

The Brucejack property hosts the Valley of the Kings (**VOK**) high-grade gold deposit. The VOK is characterised by multiple occurrences of higher grade mineralisation relative to this deposit over selected intervals hosted within broader zones of stockwork and vein arrays. Growth activities are focused on both resource expansion within the existing mine area, as well as brownfields exploration activities within 4 km of the mine area. Recent exploration has successfully expanded the footprint of the VOK deposit.

In FY23, Brucejack produced 286 koz of gold at an AISC of \$1,157 per ounce.

37. As at 30 June 2023. For tonnes and grade breakdown by confidence category refer to Table 5.5.7 for Ore Reserves and Table 5.5.1 for Mineral Resources in section 5.5.

38. As at 30 June 2023. For tonnes and grade breakdown by confidence category refer to Table 5.5.7 for Ore Reserves and Table 5.5.1 for Mineral Resources in section 5.5. Figures shown include Havieron at 100%.

39. Subject to market and operating conditions and no unforeseen delays.



5.2 Newcrest operations and projects continued

f) Red Chris

Red Chris is a copper–gold open pit mining operation located in northwest British Columbia, Canada, approximately 18 km southeast of the Iskut village, 80 km south of Dease Lake, and 12 km east of the Stewart-Cassiar Highway 37 with Ore Reserves of 7.8 Moz gold and 2.1 Mt copper, and Measured and Indicated Mineral Resources of 12 Moz gold and 3.5 Mt copper.⁴⁰

The Red Chris joint venture is an unincorporated joint venture between Newcrest Red Chris Mining Limited, a wholly owned Newcrest Subsidiary, and Red Chris Development Company Ltd, a wholly owned Subsidiary of Imperial Metals Corporation. Newcrest has a 70% joint venture interest and is the operator of Red Chris, and Imperial Metals Corporation has a 30% joint venture interest.

The Red Chris property comprises the Red Chris Main claim group and the Red Chris South group that collectively consist of 80 mineral tenures covering a total area of approximately 23,142 ha. Contiguous with these claims are the GJ, Todagin, McBride and Railway groups that collectively consist of 124 mineral tenures covering a total area of approximately 47,657 ha. The main tenures for purposes of the life of mine plan are five mining leases issued on 20 June 2012, for a term of 30 years, with an expiry date of 20 June 2042.

In March 2021, Newcrest announced its initial Mineral Resource estimate for the proposed Red Chris underground mine. In June 2021, Newcrest commenced construction of the exploration decline.

During FY22, Newcrest released the findings of the Red Chris block cave pre-feasibility study evaluating an underground block caving operation at Red Chris. In FY23, Newcrest continued development of the Red Chris exploration decline which has now advanced well over three kilometres, with the installation of the first ventilation rise largely complete. The feasibility study is on track to be completed in the second half of calendar year 2023.⁴¹

Newcrest is also undertaking a brownfields exploration program which is focused on searching for higher grade mineralisation relative to this deposit within the Red Chris porphyry corridor. This program has been successful in discovering East Ridge, and an exploration target for East Ridge was defined during FY22. East Ridge is located 300 meters to the east of East Zone, outside of Newcrest's initial Mineral Resource estimate.

In FY23, Newcrest's 70% interest in the Red Chris operation produced 39 koz of gold at an AISC of \$3,733 per ounce.

g) Havieron

Havieron is a gold-copper exploration project located in the Paterson Province in Western Australia, 45 km east of Telfer.

Havieron is operated by Newcrest under a joint venture agreement with Greatland Gold plc (**Greatland**). Newcrest is the manager and holds a 70% interest in Havieron and Greatland holds a 30% interest.

In October 2021, Newcrest announced that it had completed a pre-feasibility study for Havieron. Application for permits required to commence the development of an operating underground mine and associated infrastructure are ongoing. Various workstreams to support the development of the feasibility study continue to progress with several value enhancing options underway with the aim of maximising value and de-risking the project. The joint venture agreement includes tolling principles reflecting the intention of the parties that, subject to the feasibility study and a positive decision to mine, Havieron mineralised material will be processed at Telfer.

h) Wafi-Golpu project

The Wafi-Golpu project is located in the Morobe province of PNG, approximately 65 km southwest of the town of Lae, with Ore Reserves of 11 Moz gold and 4.9 Mt copper, and Indicated Mineral Resources of 22 Moz gold and 7.5 Mt copper.⁴⁰

The WGJV is a 50:50 unincorporated joint venture between Newcrest PNG 2 Limited (**Newcrest PNG2**), a wholly owned Newcrest Subsidiary, and Wafi Mining Limited (**Wafi Mining**), a wholly owned Harmony Gold Mining Company Limited (**Harmony**) Subsidiary. The WGJV holds two exploration licences covering a total area of approximately 129 km², registered in the names of Wafi Mining and Newcrest PNG2.

The WGJV participants have completed core drilling and numerous technical studies. A feasibility study was completed in 2016 and updated in 2018. An application for a special mining lease in respect of the project was lodged with the Mineral Resources Authority in 2016.

On 6 April 2023 Newcrest announced that WGJV signed a framework memorandum of understanding with the State of PNG. It represents progress towards the signing of a mining development contract (which is a prerequisite for the grant of a special mining lease) and confirms the parties' intent to proceed with the project, subject to finalising the permitting process and approvals of both the Newcrest and Harmony boards.

40. As at 30 June 2023. For tonnes and grade breakdown by confidence category refer to Table 5.5.7 for Ore Reserves and Table 5.5.1 for Mineral Resources in section 5.5.

41. Subject to market and operating conditions and no unforeseen delays.

5. Profile of the Newcrest Group

5.2 Newcrest operations and projects *continued*

i) Namosi

The Namosi project is located in the province of Namosi, Fiji. Namosi is owned by a joint venture, in which Newcrest holds a 73.03% interest and two other parties collectively hold the remaining 26.97% interest.

As at 30 June 2023, Namosi has Indicated Mineral Resources of 6.4 Moz of gold and 6.3 Mt copper.⁴²

j) Equity investments

Newcrest holds equity positions in several mining companies with prospective projects throughout the world. These include the investments in:

- Lundin Gold (32%), a Canadian mine development and operating company, operating the Fruta del Norte gold mine in Ecuador. Lundin Gold is listed on the TSX and the Nasdaq Stockholm. As at 30 June 2023, Newcrest held 75,780,909 shares (2022: 75,231,577) with a market value of \$907 million (2022: \$539 million) based on the closing share price on the TSX.
- SolGold plc (**SolGold**) (10.3%), an Australian, copper and gold exploration and future development company with assets in Ecuador, Chile, the Solomon Islands and Australia. SolGold is listed on the London Stock Exchange (**LSE**) and the TSX. As at 30 June 2023, Newcrest held 309,309,996 shares (2022: 309,309,996 shares) with a market value of \$62 million (2022: \$110 million) based on the closing share price on the LSE.
- Azucar Minerals Limited (19.9%), a Canadian mineral exploration company listed on the TSX. The associates' assets include the El Cobre copper/gold porphyry project near Veracruz, Mexico. As at 30 June 2023, Newcrest held 14,674,056 shares (2022: 14,674,056 shares) with a market value of \$1 million (2022: \$1 million) based on the closing share price on the TSX.
- Antipa Minerals Limited (8.9%), an Australian mineral exploration company listed on the ASX, with exploration assets in the Paterson Province of Western Australia. As at 30 June 2023, Newcrest held 356,114,785 shares (2022: 310,830,163) with a market value of \$3 million based on the closing share price on the ASX.
- Headwater (9.9%), a Canadian exploration company listed on the Canadian Securities Exchange (**CSE**), with exploration assets in Idaho-Oregon and Nevada, United States. As at 30 June 2023, Newcrest held 6,151,397 shares (2022: nil) with a market value of \$1 million based on the closing share price on the CSE.
- Metallic Minerals Corporation (9.5%), a Canadian exploration company listed on the TSX Venture Exchange (**TSX-V**), with exploration assets in Colorado, United States and Yukon Territory, Canada. As at 30 June 2023, the Newcrest Group held 15,838,593 shares (2022: nil) with a market value of \$4 million based on the close share price of the TSX-V.

5.3 Exploration

A key objective of Newcrest's greenfield exploration activities is to discover high-value gold and copper deposits which will be delivered through a portfolio of near-term and longer-term growth opportunities. The principal targets are large porphyry related gold-copper deposits, epithermal gold-silver deposits plus orogenic and sediment-hosted gold deposits.

Growth exploration activities are presently focused within seven key exploration provinces:

- the Golden Triangle (British Columbia, Canada) including the Red Chris joint venture, Brucejack and the GJ project;
- the Paterson Province including the Havieron Project, Wilki Project and Juri Joint Venture (Western Australia, Australia);
- the Drummond Basin (Queensland, Australia);
- Northern Territory (Australia);
- the Great Basin (Nevada and Oregon, United States) including the Headwater option/earn-in agreements and the Apaloosa earn-in agreement with Gunpoint Exploration Ltd;
- Northern Andes (Ecuador); and
- Southern Andes (Chile).

The key focus of the growth exploration program for Newcrest is growing the resource base at Red Chris joint venture and Brucejack within the Golden Triangle.

42. As at 30 June 2023. For tonnes and grade breakdown by confidence category refer to Table 5.5.1 for Indicated Mineral Resource in section 5.5.

5.4 Production

This section 5.4 sets out the gold, copper, silver and molybdenum production and sales information for Newcrest for FY22 and FY23.

a) Gold production and sales by site¹

Site	FY23		FY22	
	Production (oz)	Sales (oz)	Production (oz)	Sales (oz)
Cadia	596,879	612,061	560,702	543,029
Lihir	670,013	674,080	687,445	665,993
Telfer	348,823	352,388	407,550	407,094
Red Chris	39,342	39,838	42,341	40,921
Brucejack ²	286,003	269,356	114,421	120,056
Fruta del Norte ³	164,008	165,818	143,723	139,409
Total	2,105,068	2,113,541	1,956,182	1,916,502

Notes:

- All data relating to operations is shown at 100%, with the exception of Red Chris, which is shown at 70%, and Fruta del Norte, which is shown at Newcrest's 32% attributable share (through its 32% equity interest in Lundin Gold).
- Production outcomes for Brucejack for FY22 are based on the period from which Newcrest acquired control over Pretium, being the date of the last regulatory approval (25 February 2022).
- The production outcomes for Fruta del Norte are shown at Newcrest's 32% attributable share and have been sourced from Lundin Gold's news releases.

b) Copper production and sales by site¹

Site	FY23		FY22	
	Production (t)	Sales (t)	Production (t)	Sales (t)
Cadia	98,191	100,701	85,383	83,888
Telfer	16,665	16,667	13,904	14,277
Red Chris	18,293	18,842	21,363	21,313
Total	133,149	136,210	120,650	119,478

Note:

- All data relating to operations is shown at 100%, with the exception of Red Chris which is shown at 70%.

c) Silver production and sales by site¹

Site	FY23		FY22	
	Production (oz)	Sales (oz)	Production (oz)	Sales (oz)
Cadia	591,894	603,849	499,465	490,853
Lihir	30,619	30,619	16,698	16,698
Telfer	208,387	208,387	189,717	191,297
Red Chris	94,397	104,067	136,924	135,577
Brucejack ²	459,671	370,962	178,915	156,263
Total	1,384,969	1,317,884	1,021,719	990,688

Notes:

- All data relating to operations is shown at 100%, with the exception of the Red Chris operation which is shown at 70%.
- Production outcomes for Brucejack for FY22 are based on the period from which Newcrest acquired control over Pretium, being the date of the last regulatory approval (25 February 2022).

5. Profile of the Newcrest Group

5.4 Production continued

d) Molybdenum production and sales by site

Site	FY23		FY22	
	Production (t)	Sales (t)	Production (t)	Sales (t)
Cadia	660	789	277	72
Total	660	789	277	72

5.5 Mineral Resources and Ore Reserves⁴³

This section 5.5 has been prepared in accordance with the JORC Code.

Mineral Resources and Ore Reserves are classified using the JORC Code. The confidence categories assigned under the JORC Code were reconciled to the confidence categories in the Canadian Institute of Mining, Metallurgy and Petroleum (CIM) Definition Standards on Mineral Resources and Mineral Reserves, May 2014. As the confidence category definitions are the same, no modifications to the confidence categories were required.

There are differences in terminology from the JORC Code compared to the CIM Definition Standards. The term "Ore Reserves" in the JORC Code is substantially equivalent to "Mineral Reserves" using the CIM Definition Standards, and the term "Proved Ore Reserves" in the JORC Code is substantially equivalent to "Proven Mineral Reserves" using the CIM Definition Standards. It should be noted that Ore Reserves are reported as inclusive of marginally economic material and diluting material delivered for treatment or dispatched from the mine without treatment however such material does not contribute to the economic assessment of any study. There are no other material differences between JORC and the CIM Definition Standards.

The only relevant reporting differences are that National Instrument 43-101 – Standards of Disclosure for Mineral Projects (NI 43-101) reporting requirements require each category of Mineral Reserves (Ore Reserves) and Mineral Resources to be reported separately, and do not permit Inferred Mineral Resources to be added to other Mineral Resource categories. Consequently, Measured and Indicated Mineral Resources have been reported separately from Inferred Mineral Resources. Ore Reserves reported herein are classified in a manner consistent with the requirements of the JORC Code. The JORC Code differs from CIM in that it permits Ore Reserves to be estimated as inclusive of marginally economic material and diluting material (including Inferred) delivered for treatment or dispatched from the mine without treatment, and on the basis that such material (representing 7% of the gold and 5% of the copper in Ore Reserves at Wafi-Golpu, <1% of the gold and <1% of the copper at Cadia East and 2% of the gold and 1.6% of the copper in Ore Reserves at Havieron) does not materially contribute to the economic assessment of any study. While NI 43-101 restricts the inclusion of inferred material in an economic analysis it does permit for Resources and Reserves to be classified and reported in accordance with acceptable foreign standards, including the JORC Code.

Mineral Resources that are not Ore Reserves do not have demonstrated economic viability. Due to lower certainty, the inclusion of Mineral Resources should not be regarded as a representation by Newcrest that such amounts can necessarily be totally economically exploited, and investors are cautioned not to place undue reliance upon such figures. Therefore, no assurances can be given that the estimates of Mineral Resources presented in this section of the Scheme Booklet will be recovered at the tonnages and grades presented, or at all.

43. The information in this Scheme Booklet that relates to Mineral Resources and Ore Reserves has been extracted from the release titled "Annual Mineral Resources and Ore Reserves Statement – as at 30 June 2023" dated 11 August 2023 (the original release) which is available to view at www.asx.com.au under the code "NCM" and on Newcrest's SEDAR profile. Newcrest confirms that it is not aware of any new information or data that materially affects the information included in the original release and, in the case of estimates of Mineral Resources or Ore Reserves, that all material assumptions and technical parameters underpinning the estimates in the relevant market announcement continue to apply and have not materially changed. Newcrest confirms that the form and context in which the Competent Person's findings are presented have not been materially modified from the original release.



5.5 Mineral Resources and Ore Reserves *continued*

Table 5.5.1: 30 June 2023 and 30 June 2022 Gold and Copper Measured and Indicated Mineral Resources

30 June 2023 Gold and Copper Measured and Indicated Mineral Resources ¹	Measured Resources			Indicated Resources			30 June 2023 Measured and Indicated Resources					30 June 2022 Measured and Indicated Resources									
	Tonnes		Grade	Tonnes		Grade	Tonnes		Grade		Contained Metal	Tonnes		Grade		Contained Metal					
	Mt (Dry)	Au (g/t)	Cu (%)	Mt (Dry)	Au (g/t)	Cu (%)	Mt (Dry)	Au (g/t)	Cu (%)	Au (Moz)	Cu (Mt)	Mt (Dry)	Au (g/t)	Cu (%)	Au (Moz)	Cu (Mt)					
Operational Provinces																					
Cadia																					
Cadia East Underground	—	—	—	2,600	0.35	0.26	2,600	0.35	0.26	29	6.7	2,600	0.35	0.26	30	6.8					
Ridgeway Underground	—	—	—	110	0.57	0.30	110	0.57	0.30	1.9	0.31	110	0.57	0.30	1.9	0.31					
Cadia Extended Underground	—	—	—	80	0.35	0.19	80	0.35	0.19	0.89	0.15	80	0.35	0.19	0.89	0.15					
Cadia Hill Stockpiles	32	0.30	0.13	—	—	—	32	0.30	0.13	0.31	0.041	32	0.30	0.13	0.31	0.041					
Telfer																					
Telfer Open Pit Stockpiles ²	3.3	0.41	0.14	6.9	0.37	0.054	10	0.38	0.081	0.13	0.0083	21	0.37	0.068	0.26	0.014					
West Dome Open Pit ³	—	—	—	39	0.75	0.053	39	0.75	0.053	0.93	0.020	76	0.65	0.064	1.6	0.049					
Telfer Underground	—	—	—	29	1.9	0.44	29	1.9	0.44	1.8	0.13	35	1.8	0.46	2.0	0.16					
Havieron ⁴	—	—	—	28	3.2	0.51	28	3.2	0.51	2.9	0.14	28	3.2	0.51	2.9	0.14					
Satellites Deposits	—	—	—	0.44	2.9	—	0.44	2.9	—	0.040	—	0.44	2.9	—	0.040	—					
O'Callaghans ⁵	—	—	—	63	—	0.30	63	—	0.30	—	0.19	69	—	0.29	—	0.20					
Red Chris																					
Red Chris Open Pit ⁴	—	—	—	220	0.31	0.37	220	0.31	0.37	2.2	0.82	240	0.30	0.36	2.4	0.88					
Red Chris Open Pit Stockpiles ⁴	8.6	0.17	0.25	—	—	—	8.6	0.17	0.25	0.048	0.021	9.5	0.15	0.24	0.047	0.023					
Red Chris Underground ⁴	—	—	—	670	0.46	0.40	670	0.46	0.40	10	2.7	670	0.46	0.40	10	2.7					
Lihir																					
Lihir Open Pit	—	—	—	490	2.3	—	490	2.3	—	36	—	510	2.3	—	37	—					
Lihir Stockpiles	57	1.9	—	21	1.4	—	78	1.7	—	4.4	—	72	1.8	—	4.2	—					
Brucejack																					
Brucejack Underground ⁶	—	—	—	19	13	—	19	13	—	8.2	—	—	—	—	—	—					
Non-Operational Provinces																					
WGJV																					
Golpu ⁷	—	—	—	690	0.71	1.1	690	0.71	1.1	16	7.5	690	0.71	1.1	16	7.5					
Wafi ⁷	—	—	—	110	1.7	—	110	1.7	—	5.7	—	110	1.7	—	5.7	—					
Namosi JV																					
Waisoi ⁸	—	—	—	1,800	0.11	0.35	1,800	0.11	0.35	6.4	6.3	1,800	0.11	0.35	6.4	6.3					
Total Measured and Indicated Mineral Resources⁹																					
											Au	7,000	0.56	—	130	—	7,100	0.53	—	120	—
											Cu	6,400	—	0.39	—	25	6,500	—	0.39	—	25

Notes:

- All data reported here is on a 100% asset basis, with Newcrest's attributable interest shown against each asset within footnotes.
- Some partially costed stockpiles have been removed due to revised cost assumptions.
- Reduction due to increased cost assumptions and revised pit designs.
- Newcrest attributable share 70%.
- Reduction due to increase in NSR cut-off to align with internal Scoping Study outcomes.
- Initial Mineral Resources estimate for Newcrest Mining Limited.
- In March 2021, the then Governor of the Morobe Province commenced a judicial review application against the State of PNG, challenging the December 2020 grant of the environment permit for the Wafi-Golpu Project. In December 2022 a number of villagers from the Huon Gulf coastal area commenced a separate judicial review application against the State of PNG also challenging the grant of the project's Environment Permit. Both reviews are still to be heard and determined. Newcrest attributable share 50%.
- Newcrest attributable share 73.03%.
- Mineralisation is not coincident therefore total tonnages differ for each metal reported.

5. Profile of the Newcrest Group

5.5 Mineral Resources and Ore Reserves *continued*

Table 5.5.2: 30 June 2023 and 30 June 2022 Gold and Copper Inferred Mineral Resources

30 June 2023 Gold and Copper Inferred Mineral Resources ¹	30 June 2023 Inferred Resources					30 June 2022 Inferred Resources				
	Tonnes Mt (Dry)	Grade		Contained Metal		Tonnes Mt (Dry)	Grade		Contained Metal	
		Au (g/t)	Cu (%)	Au (Moz)	Cu (Mt)		Au (g/t)	Cu (%)	Au (Moz)	Cu (Mt)
Operational Provinces										
Cadia										
Cadia East Underground	500	0.24	0.17	3.8	0.85	500	0.24	0.17	3.8	0.85
Ridgeway Underground	41	0.38	0.40	0.50	0.17	41	0.38	0.40	0.50	0.17
Big Cadia	11	0.70	0.52	0.25	0.058	11	0.70	0.52	0.25	0.058
Telfer										
West Dome Open Pit	1.6	0.85	0.044	0.045	0.00072	1.5	0.79	0.079	0.038	0.0012
Telfer Underground ²	14	1.5	0.40	0.70	0.056	10	1.5	0.46	0.47	0.047
Havieron ³	57	1.4	0.14	2.6	0.082	57	1.4	0.14	2.6	0.082
Satellites Deposits	4.4	1.1	—	0.16	—	4.4	1.1	—	0.16	—
Camp Dome	14	—	0.37	—	0.052	14	—	0.37	—	0.052
O'Callaghans ⁴	6.5	—	0.26	—	0.017	9.0	—	0.24	—	0.022
Red Chris										
Red Chris Open Pit ³	7.6	0.26	0.31	0.065	0.024	8.5	0.25	0.30	0.069	0.026
Red Chris Underground ³	180	0.32	0.30	1.8	0.54	180	0.32	0.30	1.8	0.54
Lihir										
Lihir Open Pit	66	2.3	—	4.9	—	67	2.3	—	4.9	—
Brucejack										
Brucejack UG ⁵	9.6	13	—	4.0	—	—	—	—	—	—
Non-Operational Provinces										
WGJV										
Golpu ⁶	140	0.63	0.85	2.8	1.2	140	0.63	0.85	2.8	1.2
Wafi ⁶	37	1.4	—	1.6	—	37	1.4	—	1.6	—
Nambonga ⁶	48	0.69	0.20	1.1	0.094	48	0.69	0.20	1.1	0.094
Namosi JV										
Waisoi ⁷	170	0.081	0.27	0.45	0.46	170	0.081	0.27	0.45	0.46
Wainaulo ⁷	290	—	0.43	—	1.2	290	—	0.43	—	1.2
Total Inferred Mineral Resources⁸	Au	1,300	0.60	—	25	—	1,300	0.50	—	21
	Cu	1,500	—	0.32	—	4.8	1,500	—	0.32	—

Notes:

- All data reported here is on a 100% asset basis, with Newcrest's attributable interest shown against each asset within footnotes.
- Updated Mineral Resources estimate informed by remodelling, interpretation and classification based on infill and extensional drilling.
- Newcrest attributable share 70%.
- Reduction due to increase in NSR cut-off to align with internal Scoping Study outcomes.
- Initial Mineral Resources estimate for Newcrest Mining Limited.
- In March 2021, the then Governor of the Morobe Province commenced a judicial review application against the State of PNG, challenging the December 2020 grant of the environment permit for the Wafi-Golpu Project. In December 2022 a number of villagers from the Huon Gulf coastal area commenced a separate judicial review application against the State of PNG also challenging the grant of the project's Environment Permit. Both reviews are still to be heard and determined. Newcrest attributable share 50%.
- Newcrest attributable share 73.03%.
- Mineralisation is not coincident therefore total tonnages differ for each metal reported.



5.5 Mineral Resources and Ore Reserves continued

Table 5.5.3: 30 June 2023 and 30 June 2022 Silver and Molybdenum Measured and Indicated Mineral Resources

30 June 2023 Silver and Molybdenum Measured and Indicated Mineral Resources ¹	Measured Resources			Indicated Resources			30 June 2023 Measured and Indicated Resources					30 June 2022 Measured and Indicated Resources					
	Tonnes		Grade	Tonnes		Grade	Tonnes		Grade		Contained Metal	Tonnes		Grade		Contained Metal	
	Mt (Dry)	Ag (g/t)	Mo (ppm)	Mt (Dry)	Ag (g/t)	Mo (ppm)	Mt (Dry)	Ag (g/t)	Mo (ppm)	Ag (Moz)	Mo (Mt)	Mt (Dry)	Ag (g/t)	Mo (ppm)	Ag (Moz)	Mo (Mt)	
Operational Provinces																	
Cadia																	
Cadia East Underground	—	—	—	2,600	0.65	65	2,600	0.65	65	54	0.17	2,600	0.65	66	55	0.17	
Ridgeway Underground	—	—	—	110	0.74	—	110	0.74	—	2.5	—	110	0.74	—	2.5	—	
Brucejack																	
Brucejack Underground ²	—	—	—	19	34	—	19	34	—	21	—	—	—	—	—	—	
Non-Operational Provinces																	
WGJV ³																	
Golpu	—	—	—	690	1.3	—	690	1.3	—	28	—	690	1.3	—	28	—	
Wafi	—	—	—	110	4.4	—	110	4.4	—	15	—	110	4.4	—	15	—	
Total Measured and Indicated Mineral Resources ⁴							Ag	3,500	1.1	—	120	—	3,500	0.89	—	100	—
							Mo	2,600	—	65	—	0.17	2,600	—	66	—	0.17

Notes:

- All data reported here is on a 100% asset basis, with Newcrest's attributable interest shown against each asset within footnotes.
- Initial Mineral Resources estimate for Newcrest Mining Limited.
- In March 2021, the then Governor of the Morobe Province commenced a judicial review application against the State of PNG, challenging the December 2020 grant of the environment permit for the Wafi-Golpu Project. In December 2022 a number of villagers from the Huon Gulf coastal area commenced a separate judicial review application against the State of PNG also challenging the grant of the project's Environment Permit. Both reviews are still to be heard and determined. Newcrest attributable share 50%.
- Mineralisation is not coincident therefore total tonnages differ for each metal reported.

Table 5.5.4: 30 June 2023 and 30 June 2022 Silver and Molybdenum Inferred Mineral Resources

30 June 2023 Silver and Molybdenum Inferred Mineral Resources ¹	30 June 2023 Inferred Resources					30 June 2022 Inferred Resources					
	Tonnes	Grade		Contained Metal		Tonnes	Grade		Contained Metal		
	Mt (Dry)	Ag (g/t)	Mo (ppm)	Ag (Moz)	Mo (Mt)	Mt (Dry)	Ag (g/t)	Mo (ppm)	Ag (Moz)	Mo (Mt)	
Operational Provinces											
Cadia											
Cadia East Underground	500	0.47	25	7.5	0.012	500	0.47	25	7.5	0.012	
Ridgeway Underground	41	0.43	—	0.56	—	41	0.43	—	0.56	—	
Brucejack											
Brucejack Underground ²	9.6	13	—	4.1	—	—	—	—	—	—	
Non-Operational Provinces											
WGJV ³											
Golpu	140	1.1	—	4.6	—	140	1.1	—	4.6	—	
Wafi	37	4.2	—	5.0	—	37	4.2	—	5.0	—	
Total Inferred Mineral Resources ⁴	Ag	720	0.94	—	22	—	710	0.77	—	18	—
	Mo	500	—	25	—	0.012	500	—	25	—	0.012

Notes:

- All data reported here is on a 100% asset basis, with Newcrest's attributable interest shown against each asset within footnotes.
- Initial Mineral Resources estimate for Newcrest Mining Limited.
- In March 2021, the then Governor of the Morobe Province commenced a judicial review application against the State of PNG, challenging the December 2020 grant of the environment permit for the Wafi-Golpu Project. In December 2022 a number of villagers from the Huon Gulf coastal area commenced a separate judicial review application against the State of PNG also challenging the grant of the project's Environment Permit. Both reviews are still to be heard and determined. Newcrest attributable share 50%.
- Mineralisation is not coincident therefore total tonnages differ for each metal reported.

5. Profile of the Newcrest Group

5.5 Mineral Resources and Ore Reserves *continued*

Table 5.5.5: 30 June 2023 and 30 June 2022 Polymetallic Measured and Indicated Mineral Resources

	30 June 2023							30 June 2022						
	Polymetallic Measured and Indicated Resources							Polymetallic Measured and Indicated Resources						
	Tonnes	Grade			Contained Metal			Tonnes	Grade			Contained Metal		
Mt (Dry)	WO ₃ ¹ (%)	Zn (%)	Pb (%)	WO ₃ (%)	Zn (%)	Pb (%)	Mt (Dry)	WO ₃ ¹ (%)	Zn (%)	Pb (%)	WO ₃ (%)	Zn (%)	Pb (%)	
O'Callaghans														
Measured	—	—	—	—	—	—	—	—	—	—	—	—	—	—
Indicated ²	63	0.36	0.56	0.28	0.23	0.36	0.18	69	0.34	0.53	0.26	0.24	0.36	0.18

Notes:

1. WO₃ Tungsten Trioxide.
2. Reduction due to increase in NSR cut-off to align with internal Scoping Study outcomes.

Table 5.5.6: 30 June 2023 and 30 June 2022 Polymetallic Inferred Mineral Resources

	30 June 2023							30 June 2022						
	Polymetallic Inferred Resources							Polymetallic Inferred Resources						
	Tonnes	Grade			Contained Metal			Tonnes	Grade			Contained Metal		
Mt (Dry)	WO ₃ ¹ (%)	Zn (%)	Pb (%)	WO ₃ (%)	Zn (%)	Pb (%)	Mt (Dry)	WO ₃ ¹ (%)	Zn (%)	Pb (%)	WO ₃ (%)	Zn (%)	Pb (%)	
O'Callaghans														
Inferred ²	6.5	0.29	0.23	0.14	0.019	0.015	0.0088	9.0	0.25	0.19	0.11	0.023	0.017	0.0097
Total Inferred Mineral Resources	6.5	0.29	0.23	0.14	0.019	0.015	0.0088	9.0	0.25	0.19	0.11	0.023	0.017	0.0097

Notes:

1. WO₃ Tungsten Trioxide.
2. Reduction due to increase in NSR cut-off to align with internal Scoping Study outcomes.



5.5 Mineral Resources and Ore Reserves *continued*

Table 5.5.7: 30 June 2023 and 30 June 2022 Gold and Copper Ore Reserves

30 June 2023 Gold and Copper Ore Reserves ¹	Proved Reserves			Probable Reserves			30 June 2023 Proved and Probable Reserves					30 June 2022 Proved and Probable Reserves				
	Tonnes		Grade	Tonnes		Grade	Tonnes		Grade			Tonnes		Grade		
	Mt (Dry)	Au (g/t)	Cu (%)	Mt (Dry)	Au (g/t)	Cu (%)	Mt (Dry)	Au (g/t)	Cu (%)	Contained Metal (Moz)	Cu (Mt)	Mt (Dry)	Au (g/t)	Cu (%)	Contained Metal (Moz)	Cu (Mt)
Operational Provinces																
Cadia																
Cadia East Underground	—	—	—	1,200	0.42	0.29	1,200	0.42	0.29	16	3.4	1,200	0.42	0.29	16	3.5
Ridgeway Underground ²	—	—	—	80	0.54	0.28	80	0.54	0.28	1.4	0.23	80	0.54	0.28	1.4	0.23
Telfer																
Telfer Open Pit Stockpiles	—	—	—	1.6	0.43	0.097	1.6	0.43	0.097	0.022	0.0015	8.2	0.43	0.087	0.11	0.0071
West Dome Open Pit ³	—	—	—	23	0.83	0.066	23	0.83	0.066	0.62	0.015	20	0.60	0.060	0.39	0.012
Telfer Underground ⁴	—	—	—	2.0	2.1	0.69	2.0	2.1	0.69	0.14	0.014	2.5	1.7	0.68	0.14	0.017
Havieron ⁵	—	—	—	14	3.7	0.54	14	3.7	0.54	1.6	0.073	14	3.7	0.54	1.6	0.073
Red Chris																
Red Chris Open Pit ⁶	—	—	—	42	0.40	0.47	42	0.40	0.47	0.54	0.20	53	0.39	0.45	0.68	0.24
Red Chris Open Pit Stockpiles ⁶	—	—	—	7.9	0.16	0.24	7.9	0.16	0.24	0.040	0.019	9.5	0.15	0.24	0.047	0.023
Red Chris Underground ⁷	—	—	—	410	0.55	0.45	410	0.55	0.45	7.2	1.8	410	0.55	0.45	7.2	1.8
Lihir																
Lihir Open Pit ⁸	—	—	—	220	2.5	—	220	2.5	—	18	—	230	2.4	—	18	—
Lihir Stockpiles ⁸	57	1.9	—	26	1.3	—	83	1.7	—	4.5	—	72	1.8	—	4.2	—
Brucejack																
Brucejack Underground ⁹	—	—	—	14	8.4	—	14	8.4	—	3.7	—	—	—	—	—	—
Non-Operational Provinces																
Wafi-Golpu																
WGJV – Golpu ^{10, 11}	—	—	—	400	0.86	1.2	400	0.86	1.2	11	4.9	400	0.86	1.2	11	4.9
					Au		2,500	0.81	—	64	—	2,500	0.76	—	61	—
Total Ore Reserves¹²					Cu		2,100	—	0.50	—	11	2,200	—	0.49	—	11

Notes:

- All data reported is on a 100% asset basis, with Newcrest's attributable interest shown against each asset within footnotes.
- Ridgeway is currently on care and maintenance subject to further studies, all necessary approvals, permits, internal and regulatory requirements and further works.
- New pit designs to include additional staged mining areas.
- Mining depletion partially offset by Ore Reserves increase due to Mineral Resources model update.
- A Feasibility Study for Havieron is currently in progress. Newcrest attributable share 70%.
- Reduction due to removal of waste stripping and changes to mine design. Newcrest attributable share 70%.
- Red Chris Block Cave Feasibility Study is in progress and due for completion in H2 calendar year 2023. Newcrest attributable share 70%.
- Changes are aligned with the FY23 Life of Province Plan.
- Initial Ore Reserves estimate for Newcrest Mining Limited.
- In March 2021, the then Governor of the Morobe Province commenced a judicial review application against the State of PNG, challenging the December 2020 grant of the environment permit for the Wafi-Golpu Project. In December 2022 a number of villagers from the Huon Gulf coastal area commenced a separate judicial review application against the State of PNG also challenging the grant of the project's Environment Permit. Both reviews are still to be heard and determined. Newcrest attributable share 50%.
- Golpu Ore Reserves is based on the 2018 Feasibility Study Update which used a gold price of US\$1,200 per ounce and USD:PGK foreign exchange of 3.13.
- Mineralisation is not coincident therefore total tonnages differ for each metal reported.

5. Profile of the Newcrest Group

5.5 Mineral Resources and Ore Reserves *continued*

Table 5.5.8: 30 June 2023 and 30 June 2022 Silver and Molybdenum Ore Reserves

30 June 2023 Silver and Molybdenum Ore Reserves ¹	Proved Reserves			Probable Reserves			30 June 2023 Proved and Probable Reserves					30 June 2022 Proved and Probable Reserves				
	Tonnes		Grade	Tonnes		Grade	Tonnes		Grade		Contained Metal	Tonnes		Grade		Contained Metal
	Mt (Dry)	Ag (g/t)	Mo (ppm)	Mt (Dry)	Ag (g/t)	Mo (ppm)	Mt (Dry)	Ag (g/t)	Mo (ppm)	Ag (Moz)	Mo (Mt)	Mt (Dry)	Ag (g/t)	Mo (ppm)	Ag (Moz)	Mo (Mt)
Operational Provinces																
Cadia																
Cadia East Underground	—	—	—	1,200	0.69	81	1,200	0.69	81	26	0.096	1,200	0.70	82	27	0.099
Ridgeway Underground ²	—	—	—	80	0.66	—	80	0.66	—	1.7	—	80	0.66	—	1.7	—
Brucejack																
Brucejack Underground ³	—	—	—	14	32	—	14	32	—	14	—	—	—	—	—	—
Ag																
							1,300	1.0	—	42	—	1,300	0.69	—	29	—
Mo																
Total Ore Reserves⁴							1,200	—	81	—	0.096	1,200	—	82	—	0.099

Notes:

- All data reported here is on a 100% asset basis, with Newcrest's attributable interest shown against each asset within footnotes.
- Ridgeway is currently on care and maintenance subject to further studies, all necessary approvals, permits, internal and regulatory requirements and further works.
- Initial Ore Reserves estimate for Newcrest Mining Limited.
- Mineralisation is not coincident therefore total tonnages differ for each metal reported.

5.6 Safety, health, sustainability and environment

Safety and sustainability are core to the operation of Newcrest's business and Newcrest is committed to:

- creating a work environment where everyone can go home safe and healthy every day, and where everyone actively contributes to this outcome;
- operating and developing mines in line with environmental, social and governance practices;
- developing a diverse workforce; and
- maintaining strong relationships with communities and governments.

Newcrest's approach to safety, health, sustainability and environment, including progress against targets and annual performance, is guided by Newcrest's policies and described in Newcrest's Sustainability Reports and Annual Reports www.newcrest.com/investor-centre/results-reports.

Newcrest's commitments to safety, health, sustainability and environment is complemented by its industry memberships and related principles and guidelines that Newcrest has adopted including: the International Council on Mining and Metals (**ICMM**) and the Ten Principles for Sustainable Mining; the World Gold Council's Responsible Gold Mining Principles; and the Minerals Council of Australia's Enduring Value framework for sustainable mining.

a) Safety and health

The Newcrest Safety and Health Policy outlines Newcrest's intent to build a strong, supportive health and safety culture based upon visible leadership, consultation and engagement.

To meet this intent, the Newcrest Safety Transformation Plan was developed and implemented with core components including NewSafe Leadership (health and safety behavioural cultural program), field Critical Control Management verifications and Process Safety, which combine to support the intent of eliminating fatalities and injuries from Newcrest's business.

Newcrest's group safety and health standards support Newcrest's Safety and Health Policy by setting the minimum performance levels expected across Newcrest sites and businesses, complemented by group and site level procedures which articulate how a standard is to be implemented.



5.6 Safety, health, sustainability and environment *continued*

For the 12 months to 30 June 2023 Newcrest reported a Total Recordable Injury Frequency Rate (**TRIFR**) of 2.97 per million hours worked. Newcrest's health and safety statistics between FY19 – FY23⁴⁴ are summarised below.

	FY19	FY20	FY21	FY22	FY23
Fatalities	0	0 ¹	0	0	1
Lost Time Injury Frequency Rate (LTIFR)	0.4	0.5	0.5	0.8	0.7
Total Recordable Injury Frequency Rate (TRIFR)	2.3	2.6	2.3	4.0	3.0

Note:

1. On 31 July 2020, an employee of Pretium was fatally injured during maintenance activities at a support facility on surface. The tragic incident occurred prior to Newcrest's acquisition of Pretium which completed on 9 March 2022.

As an extension of Newcrest's focus on Health and Safety, Newcrest has established a Respect@Work framework that aims to eliminate sexual assault and sexual harassment (**SASH**), and harassment and unacceptable behaviour more generally, across the company. The design of the framework was based on the recommendations of the Respect@Work: Sexual Harassment National Inquiry Report (2020) by the Australian Human Rights Commission and an internal review by KPMG in 2021.

Respect@Work activities during FY23 included: establishment of the Respect@Work business function (within the People and Culture department), policy and process updates, working group consultation, a Respect@Work pulse survey, commencement of SASH risk assessments and accommodation audits at operating sites. Newcrest also launched Upstander and FeelSafe training programs to encourage and educate its workforce on how to speak up in difficult situations and promote an inclusive and psychologically safe workplace.

b) Sustainability

The Newcrest Sustainability Policy outlines Newcrest's sustainability vision and commitments, in support of industry requirements and frameworks, including the United Nations Sustainable Development Goals (**SDGs**). The Newcrest Integrated Sustainability Framework (**ISF**) articulates Newcrest's approach to integrating sustainability into its business and sets out what sustainability means to Newcrest. The ISF is centred around four goals:

- Improving people's lives;
- Respecting the environment;
- Building a business for the future; and
- Being a trusted company.

Newcrest is committed to respecting the human rights of all our stakeholders and the laws of the countries in which we operate. Human rights include respect for cultural heritage, respect for Traditional owners, First Nations and Indigenous Peoples rights, security and human rights, as well as managing the risk to human rights in Newcrest's supply chains. It also includes the human rights of Newcrest's employees and contractors, including fair work, diversity, inclusion and freedom from harassment and discrimination.

In recognition of the global focus on climate change as a key element of sustainability, and our role in reducing carbon emissions and at Newcrest's operations, Newcrest has committed to a 30% reduction in Scope 1 and 2 greenhouse gas (**GHG**) emissions intensity per tonne of ore milled by 2030 against the FY18 base year⁴⁵, and has a goal of net zero Scope 1 and Scope 2 carbon emissions by 2050. Newcrest continues to develop and implement a Net Zero Roadmap to meet this goal. As part of that Roadmap, fleet electrification remains a key focus across the business, with eight new electric underground trucks at Brucejack, an electric scoop (load haul dump) trial continuing at Brucejack and planning for other electric trials at Cadia. Newcrest has a 15-year renewable Power Purchase Agreement (**PPA**) with Tilt Renewables which is estimated to satisfy part of Cadia's future projected energy requirements. In July 2023, the first renewable power was generated from the Rye Park Wind Farm (operated by Tilt Renewables) and the wind farm is expected to be fully operational in mid-2024.⁴⁶

To deliver programs that contribute to the resilience of communities in Newcrest's geographical areas of interest and to support the United Nations SDGs, Newcrest launched a A\$10 million Newcrest Sustainability Fund in July 2022. Contributions to eight major projects and two emergency response projects, which have a focus across health, education, biodiversity, reduction in inequalities and economic growth outcomes, were approved during FY23.

44. In line with ICMM guidelines, the calculation of company-wide TRIFR and LTIFR only includes operational sites and joint ventures in which Newcrest has a controlling interest; therefore, Wafi-Golpu is excluded. Figures are rounded to one decimal.

45. Using the metric of kg CO₂-e/t ore milled.

46. Subject to market and operating conditions and no unforeseen delays.

5. Profile of the Newcrest Group

5.6 Safety, health, sustainability and environment *continued*

c) Environment

Newcrest's environmental policy is supported by a number of performance standards that guide Newcrest's risk-based approach to management of water stewardship, land use and disturbance, biodiversity, waste rock and tailings management, hazardous waste and closure planning. Environmental incidents are reported, investigated and assessed according to their environmental consequences and relevant authorities are notified where required and remedial action is undertaken.

Newcrest's sites use water from various sources including surface water, groundwater, recycled water, seawater, reclaimed water from tailings storage facilities and mine dewatering. Where practical Newcrest recycles water to reduce consumption. Newcrest has developed a water stewardship policy and water stewardship maturity framework to promote a catchment-based approach to management of water aspects within the specific community and watershed context of each site.

The Newcrest Tailings Governance Policy and Newcrest Tailings and Water Storage Standard outline the processes to operate Newcrest's tailings storage facilities. These documents are aligned with the ICMM Position Statement on Preventing Catastrophic Failure of Tailings Storage Facilities and the Global Industry Standard on Tailings Management (**GISTM**). As a member of the ICMM, Newcrest is committed to conforming with GISTM for all facilities and continues to work towards conformance, whilst prioritising dam integrity improvements.

Deep Sea Tailings Placement (**DSTP**) was chosen by the initial operator of Lihir as the preferred tailings management method as an outcome of project studies which evaluated social, environmental and safety risks. The integrity of the DSTP system at Lihir is regularly inspected and includes an alarm system to track potential changes in normal operating conditions. The latest five yearly offshore marine survey of the Lihir DSTP system which complements monthly and annual monitoring programs, commenced in 2022 and is continuing into 2023. DSTP has also been selected as the preferred tailings management option for Wafi-Golpu. The Wafi-Golpu Environmental Impact Statement (**EIS**) is publicly available on the Wafi-Golpu Joint Venture (**WGJV**) website and includes information on comprehensive DSTP studies used to inform the selection of DSTP as the preferred tailings management option for Wafi-Golpu.

Tailings and waste rock are two significant waste streams for Newcrest, which are managed with the intention to facilitate long-term geochemical and physical stability at Newcrest's sites. The Newcrest Non-Mineral Waste and Hydrocarbon and Chemical Standard (that includes hazardous chemicals) outlines requirements for sites to manage waste streams. In addition, Newcrest is a member of the international Cyanide Code which means sites that use cyanide are regularly externally certified to the Cyanide Code.

Newcrest's Biodiversity Policy and Biodiversity Management Standard outlines Newcrest's approach to manage its potential impacts on biodiversity related to Newcrest's operations in areas under its control or influence, including progression of Biodiversity Action Plans for each of Newcrest's operations and working towards Newcrest's objective to have no net loss of biodiversity values at new projects.

Newcrest's approach to mine closure is detailed in policies and standards that require the ongoing assessment of environmental and social aspects and regular update of financial provisions throughout the life of the mine. Environmental, planning, heritage and other regulatory approvals also contain key requirements as to the closure of mine operations that are incorporated into site closure plans.

The Newcrest air quality standard defines requirements for each site to assess the risks associated with air emissions and apply appropriate controls in consideration of relevant regulatory approvals and licence conditions. The Cadia mine has been engaging with regulators and the local community regarding improvements to the management of dust emissions from underground ventilation rises and tailings storage facilities (as reported in Newcrest's annual Sustainability Reports, as well as Newcrest's annual and quarterly reports). Refer to Section 8.4(b)(1)(B) for further information.

d) Governance

The Newcrest Board determines the strategic direction of Newcrest and is accountable for monitoring the effectiveness of Newcrest's programs, practices and measures in relation to sustainability. The Safety and Sustainability Committee (**SSC**), a committee of the Newcrest Board, assists the Newcrest Board by overseeing, monitoring and reviewing Newcrest's practices and governance in safety; occupational health and hygiene; sustainability; environment; climate change; social performance; and the human rights and security of communities, employees and operations (collectively, the **SSC Areas**).

Within its scope the SSC recommends to the Newcrest Board key policies and strategies in relation to the SSC Areas, monitors and reviews Newcrest's responsibilities, commitments and performance in relation to the SSC Areas, oversees the setting of public targets relating to the SSC Areas and the making of significant public statements, oversees processes designed to support compliance with applicable policies and legal and regulatory requirements, reviews Newcrest's response on issues of concern or non-compliance and reviews recommendations from management in relation to industry trends and standards relating to the SSC Areas. The SSC assists the Newcrest Board with oversight of the risk framework and management systems relating to the SSC Areas and oversight of identification, management and mitigation of risks with respect to the SSC Areas, while the Audit and Risk Committee assists the Newcrest Board in fulfilling its responsibilities concerning oversight of Newcrest's overall risk management framework and processes.



5.7 Newcrest Board and senior management

a) Newcrest Board

The Newcrest Board comprises the following directors:

Name	Position
Peter Tomsett	Independent Chairman
Philip Aiken AM	Independent Non-Executive Director
Philip Bainbridge	Independent Non-Executive Director
Roger Higgins	Independent Non-Executive Director
Sally-Anne Layman	Independent Non-Executive Director
Jane McAloon AM	Independent Non-Executive Director
Vickki McFadden	Independent Non-Executive Director

b) Newcrest senior management

Newcrest's senior management team comprises the following members:

Name	Position
Sherry Duhe	Interim Chief Executive Officer
Megan Collins	Chief People and Culture Officer
Craig Jones	Interim Chief Operating Officer
Dan O'Connell	Interim Chief Financial Officer
Maria Sanz Perez	Chief Legal, Risk and Compliance Officer & Company Secretary
Suresh Vadnagra	Chief Technical & Projects Officer
Beth White	Chief Sustainability Officer

5.8 Historical financial information of Newcrest

a) Overview

The historical financial information of the Newcrest Group set out in this section 5.8 comprises:

- Newcrest historical consolidated income statements for the years ended 30 June 2023 (**FY23**), 30 June 2022 (**FY22**) and 30 June 2021 (**FY21**) (**Newcrest Historical Statements of Operations**);
- Newcrest historical consolidated statement of financial position as at 30 June 2023 (**Newcrest Historical Balance Sheet**); and
- Newcrest historical consolidated statements of cash flows for FY23, FY22 and FY21 (**Newcrest Historical Statements of Cash Flows**), (collectively, the **Newcrest Historical Financial Information**).

The Newcrest Historical Financial Information has been reviewed by Ernst & Young Strategy and Transactions Limited (as Investigating Accountant), in accordance with the Australian Standard on Assurance Engagements ASAE 3450 *Assurance Engagements involving Corporate Fundraisings and/or Prospective Financial Information*, as stated in its Independent Limited Assurance Report, included in Annexure 2. Newcrest Shareholders should note the scope and limitations of the Independent Limited Assurance Report.

The Newcrest Group's full year consolidated financial statements, including all notes to those consolidated financial statements and a description of the Newcrest Group's significant accounting policies can be found in:

- the Newcrest Group's Appendix 4E and Annual Financial Report for the financial year ended 30 June 2023 (released to the ASX on 11 August 2023);
- the Newcrest Group's Appendix 4E and Annual Financial Report for the financial year ended 30 June 2022 (released to the ASX on 19 August 2022); and
- the Newcrest Group's Appendix 4E and Annual Financial Report for the financial year ended 30 June 2021 (released to the ASX on 19 August 2021).

The full reports are available on Newcrest's website at www.newcrest.com or on the ASX (www.asx.com.au), PNGX (www.pngx.com.pg) and TSX (via SEDAR) (www.sedar.com).

This section 5.8 should be read in conjunction with the risks to which Newcrest is subject and the risks associated with the Scheme, as set out in section 8.

5. Profile of the Newcrest Group

5.8 Historical financial information of Newcrest *continued*

b) Basis of preparation

The Newcrest Historical Financial Information is intended to present Newcrest Shareholders with information to assist them in understanding the historical financial performance, financial position and cash flows of the Newcrest Group. The Newcrest Board is responsible for the preparation and presentation of the Newcrest Historical Financial Information.

The Newcrest Historical Financial Information has been prepared on a going concern basis, which assumes continuity of normal business activities and the realisation of assets and the settlement of liabilities in the ordinary course of business.

The Newcrest Historical Financial Information has been prepared in accordance with the recognition and measurement principles of Australian Accounting Standards (AAS) issued by the Australian Accounting Standards Board (AASB), which are consistent with International Financial Reporting Standards (IFRS) issued by the International Accounting Standards Board (IASB). The accounting policies used in preparation of the Newcrest Historical Financial Information are consistent with those set out in Newcrest's Annual Financial Report for the year ended 30 June 2023.

The Newcrest Historical Financial Information has been derived from the Newcrest Group's consolidated financial statements for FY23 and FY22 (which includes comparative information for FY21). The Newcrest Historical Financial Information is presented in USD and, unless otherwise noted, is rounded to the nearest USD million.

The Newcrest Group's consolidated financial statements for FY23 and FY22, which were prepared in accordance with AAS and are consistent with IFRS, were audited by Newcrest's auditor, Ernst & Young, in accordance with Australian Auditing Standards. Ernst & Young issued unqualified audit opinions on these consolidated financial statements.

The Newcrest Historical Financial Information is presented in an abbreviated form insofar as it does not include all the presentation, disclosures, statements, or comparative information that is required by AAS and other mandatory professional reporting requirements applicable to general purpose financial reports prepared in accordance with the Corporations Act.

c) Newcrest Historical Statements of Operations

Table 5.8.1 Newcrest Historical Statements of Operations

Newcrest Historical Statements of Operations for FY23, FY22 and FY21 are set out in the following table.

	FY23 \$ millions	FY22 \$ millions	FY21 \$ millions
Revenue	4,508	4,207	4,576
Cost of sales	(3,282)	(2,853)	(2,805)
Gross profit	1,226	1,354	1,771
Exploration expenses	(76)	(76)	(69)
Corporate administration expenses	(138)	(138)	(143)
Other income / (expenses)	141	119	185
Share of profit / (loss) of associates	19	45	26
Profit before interest and income tax	1,172	1,304	1,770
Finance income	41	25	27
Finance costs	(137)	(100)	(129)
Net finance costs	(96)	(75)	(102)
Profit before income tax	1,076	1,229	1,668
Income tax expense	(298)	(357)	(504)
Profit after income tax	778	872	1,164
Non-controlling interests	—	—	—
Profit after income tax attributable to owners of Newcrest	778	872	1,164



5.8 Historical financial information of Newcrest continued

d) Newcrest Historical Balance Sheet

Table 5.8.2 Newcrest Historical Balance Sheet

Newcrest Historical Balance Sheet as at 30 June 2023 is set out in the following table.

	30 June 2023 \$ millions
Cash and cash equivalents	586
Trade and other receivables	254
Inventories	615
Other financial assets	60
Current tax assets	58
Other assets	80
Total current assets	1,653
Trade and other receivables	109
Inventories	1,116
Other financial assets	351
Property, plant and equipment	12,996
Goodwill	686
Other intangible assets	32
Deferred tax assets	50
Investment in associates	483
Other assets	45
Total non-current assets	15,868
Total assets	17,521
Trade and other payables	693
Lease liabilities	45
Provisions	176
Current tax liability	37
Other financial liabilities	33
Total current liabilities	984
Borrowings	1,935
Lease liabilities	65
Provisions	511
Deferred tax liabilities	2,314
Total non-current liabilities	4,825
Total liabilities	5,809
Net assets	11,712
Issued capital	13,764
Accumulated losses	(1,440)
Reserves	(612)
Total equity	11,712

5. Profile of the Newcrest Group

5.8 Historical financial information of Newcrest continued

e) Newcrest Historical Statements of Cash Flows

Table 5.8.3 Newcrest Historical Statements of Cash Flows

Newcrest Historical Statements of Cash Flows for FY23, FY22 and FY21 are set out in the following table.

	FY23 \$ millions	FY22 \$ millions	FY21 \$ millions
Cash flows from operating activities			
Profit before income tax	1,076	1,229	1,668
Adjustments for:			
Depreciation and amortisation	891	750	673
Net finance costs	96	75	102
Net fair value gain on Fruta del Norte finance facilities	(143)	(62)	(118)
Exploration expenditure written off	76	76	69
Share of profit of associates	(19)	(45)	(26)
Other non-cash items or non-operating items	(35)	(18)	58
Change in working capital	(107)	(76)	155
Operating cash flows before interest and taxes	1,835	1,929	2,581
Interest received	217	86	61
Interest paid	(118)	(91)	(107)
Income tax paid	(359)	(244)	(233)
Dividends received	30	—	—
Net cash provided by operating activities	1,605	1,680	2,302
Cash flows from investing activities			
Payments for plant and equipment, development and feasibility	(961)	(1,181)	(940)
Production stripping expenditure	(206)	(213)	(148)
Exploration and evaluation expenditure	(143)	(120)	(115)
Information systems development	(7)	(12)	(20)
Cash consideration for acquisition of Pretium, net of cash acquired	—	(1,084)	—
Net receipts from Fruta del Norte finance facilities	116	51	38
Payments for investments in associates	(13)	(7)	(21)
Proceeds from contingent consideration	10	—	—
Proceeds from sale of property, plant and equipment	3	1	8
Proceeds from sale of royalty portfolio	—	36	—
Payment for purchase of put option	—	(19)	—
Net cash used in investing activities	(1,201)	(2,548)	(1,198)
Cash flows from financing activities			
Proceeds from borrowings – Bilateral bank debt	1,659	860	—
Repayment of borrowings:			
Bilateral bank debt	(1,504)	(717)	—
Corporate bonds	—	—	(380)
Convertible notes	—	(52)	—
Term facility	—	(88)	—
Other loans	—	—	(3)
Payment for treasury shares	(8)	(14)	(10)
Repayment of lease principal	(49)	(43)	(32)
Other financing activities	—	(1)	(20)
Dividends paid to members of Newcrest	(477)	(372)	(240)
Net cash used in financing activities	(379)	(427)	(685)
Net increase / (decrease) in cash and cash equivalents	25	(1,295)	419
Cash and cash equivalents at the beginning of the year	565	1,873	1,451
Effects of exchange rate changes on cash held	(4)	(13)	3
Cash and cash equivalents at the end of the year	586	565	1,873



5.9 Newcrest Directors' intentions

The Corporations Regulations require a statement by the Newcrest Directors of their intentions regarding Newcrest's business. If the Scheme is implemented, Newcrest will procure that any Newcrest Director nominated by Newmont to resign from the Newcrest Board will resign and Newmont will have 100% ownership and control of Newcrest. The current intentions of Newmont with respect to these matters are set out in Section 7.3.

If the Scheme is not implemented, the Newcrest Directors intend to continue to operate Newcrest in the ordinary course of business and for Newcrest to remain listed on the ASX, PNGX and TSX.

5.10 Material changes in financial position (since 30 June 2023)

Other than as disclosed in this Scheme Booklet or announced to the ASX, PNGX or TSX (via SEDAR) by Newcrest, within the knowledge of the Newcrest Board, as at the Last Practicable Date, the financial position of Newcrest Group has not materially changed since 30 June 2023, being the latest date of the statement of financial position available for Newcrest as disclosed in its Annual Financial Report for the year ended 30 June 2023.

5.11 Capital structure

As at the Last Practicable Date, the capital structure of Newcrest was:

Type of security	Number on issue
Newcrest Shares	894,230,732
Newcrest Equity Incentives	2,814,919 performance rights ¹

Note:

1. No further Newcrest Shares will be issued in respect of these performance rights in connection with the implementation of the Scheme.

Additional details about Newcrest's equity incentive plan are set out in section 11.2.

5.12 Substantial holders in Newcrest Shares

As extracted from filings released on the ASX on or before the Last Practicable Date, the following persons were substantial holders of Newcrest Shares:

Substantial holder	Number of Newcrest Shares	Voting power in Newcrest
BlackRock Group and associates	87,666,192	9.80%
Allan Gray Australia Pty Ltd and associates	56,379,115	6.30%
State Street Corporation and associates	54,568,016	6.11%
The Vanguard Group, Inc. and associates	44,763,930	5.00%

5.13 Publicly available information about Newcrest

Newcrest is a listed disclosing entity for the purpose of the Corporations Act and as such is subject to regular reporting and disclosure obligations. Specifically, as a company listed on the ASX, Newcrest is subject to the ASX Listing Rules which require (subject to some exceptions) continuous disclosure of any information that Newcrest has that a reasonable person would expect to have a material effect on the price or value of Newcrest Shares. Information disclosed by Newcrest under the ASX Listing Rules must also be disclosed to PNGX.

Newcrest is also subject to certain Canadian disclosure requirements and standards as a result of its secondary listing on the TSX, including the requirements of NI 43-101.

ASX, PNGX and the Canadian Securities Administrators maintain files containing publicly disclosed information about listed entities on those stock exchanges. Information is disclosed by Newcrest to the ASX (www.asx.com.au), PNGX (www.pngx.com.pg) and TSX (via SEDAR) (www.sedar.com).

In addition, Newcrest is required to lodge various documents with regulators, including ASIC and the PNG Companies Office. Copies of documents lodged with ASIC by Newcrest may be obtained from an ASIC office.

Newcrest Shareholders may obtain a copy of Newcrest's Appendix 4E and Annual Financial Reports for the years ended 30 June 2022 and 2023 from the ASX (www.asx.com.au), PNGX (www.pngx.com.pg) and TSX (via SEDAR) (www.sedar.com), from Newcrest's website (www.newcrest.com) or by calling the Newcrest Shareholder Information Line on 1800 425 578 (within Australia) or +61 1800 425 578 (outside Australia), between 8.30am and 7.30pm (Melbourne time), Monday to Friday (excluding public holidays).

6. Profile of the Newmont Group⁴⁷

6.1 Overview of Newmont

a) Background and history

Newmont is the world's leading gold company, and is also engaged in the production of copper, silver, lead and zinc.

Newmont was founded in 1921 and has been publicly traded since 1925 (and on the NYSE since 1940). Newmont's corporate headquarters are located in Denver, Colorado (United States) and Newmont maintains offices in Perth (Australia), Miami (United States), Vancouver (Canada) and Accra (the Republic of Ghana).

Newmont's world-class portfolio of assets, prospects and talent is anchored in favourable mining jurisdictions in Australia, North America, South America and Africa. Newmont currently has twelve actively managed operating mines in eight countries across four continents, as well as a portfolio of mining and exploration projects.

Newmont is the only gold producer listed in the S&P 500 Index and is widely recognised for its principled environmental, social and governance practices. Newmont is an industry leader in value creation, supported by robust safety standards, superior execution and technical proficiency.

In the six months ended 30 June 2023, Newmont's total revenue was \$5,362 and its net income attributable to common shareholders was \$506. As at 30 June 2023, Newmont's consolidated total assets were approximately \$38,133 and its total equity was approximately \$19,415.

b) Strategy

Newmont's purpose is to create value and improve lives through sustainable and responsible mining. See section 6.6 for more details regarding Newmont's strategy.

c) Overview of Newmont Overseas

Newmont Overseas is an Australian proprietary company limited by shares that was incorporated on 9 May 2023 and is a wholly owned indirect Subsidiary of Newmont. Prior to the Scheme, it has not and will not conduct any business and does not currently own any assets or have any liabilities. If the Scheme is implemented, Newmont Overseas will directly hold all the shares in Newcrest.

6.2 Newmont operations and projects

Cautionary statement regarding Foreign Estimates

Newmont's disclosures of Foreign Estimates are not reported in accordance with the JORC Code. The technical information contained in this Scheme Booklet relating to Newmont's mining projects has been prepared in accordance with Subpart 1300.

A competent person has not done sufficient work to classify the Foreign Estimates as Mineral Resources or Ore Reserves in accordance with the JORC Code. It is uncertain that following evaluation and/or further exploration work that the Foreign Estimates would be able to be reported as Mineral Resources or Ore Reserves in accordance with the JORC Code.

If the Scheme is implemented, Newcrest will apply to be delisted from the Official List of the ASX and Newmont intends to apply for admission to the Official List of the ASX as a Foreign Exempt Listing. If admitted as a Foreign Exempt Listing, Newmont will be exempt from complying with ASX Listing Rule 5.12 and will instead continue to comply with Subpart 1300 in respect of resources and reserves reporting. **As such, Newmont has no intention to present the Foreign Estimates in accordance with the JORC Code, or otherwise to verify them for this purpose.**

Newmont's mineral reserves and mineral resources are reported on an attributable basis and the mineral resources are exclusive of reserves.

See the disclosures required by ASX Listing Rule 5.12 in section 6.4(c).

A comparison of the differences in resource categorisation under the JORC Code and Subpart 1300 is set out in section 11.12(b).

Please see section 11.13(b) for more information.

47. All financial amounts in this section 6 (other than sections 6.3, 6.4, 6.7 and 6.11) are expressed in United States currency and shown in millions of United States dollars, rounded to the nearest million.



6.2 Newmont operations and projects *continued*

Newmont's operations consist of twelve mine sites, two joint ventures, and various projects, as depicted in figure 1 below.

Figure 1: Newmont's operations



Operation	Section
Cripple Creek & Victor	Section 6.2(a)
Musselwhite	Section 6.2(b)
Porcupine	Section 6.2(c)
Éléonore	Section 6.2(d)
Peñasquito	Section 6.2(e)
Merian	Section 6.2(f)
Cerro Negro	Section 6.2(g)
Pueblo Viejo	Section 6.2(h)
Yanacocha	Section 6.2(i)
Boddington	Section 6.2(j)
Tanami	Section 6.2(k)
Ahafo South	Section 6.2(l)
Afaho North	Section 6.2(l)
Akyem	Section 6.2(m)
Nevada Gold Mines	Section 6.2(n)

6. Profile of the Newmont Group

6.2 Newmont operations and projects *continued*

a) Cripple Creek & Victor, United States

Cripple Creek & Victor (**CC&V**) is an open pit operation located next to the town of Victor and the city of Cripple Creek, Colorado, USA. The operation comprises two state mining leases, three surface parcels, 154 mineral parcels, 1,753 patented mining claims and 13 unpatented lode claims encompassing a total area of 12,985 acres (5,255 hectares).

The project is 100% owned by Newmont through its wholly owned Subsidiary, Cripple Creek & Victor Gold Mining Company LLC.

CC&V is an epithermal alkalic deposit with heap leaching facilities and a mill, which consists of a crushing and grinding circuit, located on site. The mill is currently idled as of 31 December 2022.

The available mining fleet consists of two hydraulic shovels, two loaders, and 21 haul trucks, each with a 250 tonne payload. CC&V's gross property, plant and mine development at 31 December 2022 was \$574.

CC&V produced 182,000 ounces of gold in 2022 and reported 1.6 Moz of gold reserves at 31 December 2022.

In December 2021, CC&V entered into a settlement agreement with the Water Quality Control Division of the Colorado Department of Public Health and Environment to mutually resolve issues regarding the new water quality limits contained in discharge permits issued from January 2021.

b) Musselwhite, Canada

Musselwhite is an underground operation located approximately 430 km north of Thunder Bay, Ontario, Canada. It comprises 929 mining claims and 338 mining leases which expire between 2025 and 2033. The project covers an area of 13,366 acres (5,409 hectares).

Musselwhite is 100% owned by Newmont through its wholly owned Subsidiary, Goldcorp Canada Ltd.

Musselwhite is an iron formation hosted gold deposit. Its process facilities include a conventional mill, which consists of a crushing and grinding circuit, carbon-in-pulp and carbon-in-leach plants, elution circuits and an electrowinning plant where the gold is recovered and smelted to produce doré. The available mining fleet consists of 11 underground loaders and 14 haul trucks (with a total payload of 45 tonnes).

At 31 December 2022, Musselwhite's gross property, plant and mine development was \$1,194 and it reported 1.9 Moz of gold reserves. In 2022, Musselwhite produced 173,000 ounces of gold.

c) Porcupine, Canada

Porcupine consists of the Hollinger open pit and Hoyle Pond underground operations located in the city of Timmins, Ontario, as well as the Borden underground operation, located near the town of Chapleau, Ontario, Canada. It comprises 1,129 mining claims, 983 mining patents, and 113 mining leases and encompasses an area of 340,420 acres (137,763 hectares).

Porcupine is 100% owned by Newmont through its wholly owned Subsidiary, Goldcorp Canada Ltd.

Mineralisation at Hollinger and Hoyle, in Timmins, comprises multiple generations of quartz-carbonate-tourmaline albite veins, associated pyrite alteration envelopes, and disseminated pyrite mineralisation. Mineralisation at Borden consists of a shear zone containing quartz vein hosted sulphides within a high-grade metamorphic greenstone package.

Process facilities, located in the city of Timmins, include a conventional mill, which consists of a crushing and grinding circuit, carbon-in-pulp and carbon-in-leach plants, Knelson concentrators, Acacia reactor, elution circuits and an electrowinning plant where the gold is recovered and smelted to produce doré. The available mining fleet consists of two hydraulic shovels, three loaders, 19 underground loaders and 24 haul trucks, with truck payloads ranging from 24 to 137 tonnes.

The Porcupine operations produced 280,000 ounces of gold in 2022. At 31 December 2022, Porcupine's gross property, plant and mine development was valued at \$1,672 and it reported 2.3 Moz of gold reserves.

Goodwill attributable to the Porcupine project deteriorated in 2022, driven by a reduction in underlying cash flows from higher costs due to inflationary pressures, higher capital costs related to safety enhancements and the expansion of the active tailings storage facilities, ensuring GITSM compliance, as well as an increase to the asset retirement costs.

d) Éléonore, Canada

Éléonore is an underground operation, located approximately 825 km north of Montreal in Eeyou Istchee/James Bay in Northern Quebec, Canada. It comprises 368 mining claims and one mining lease and encompasses 48,210 acres (19,511 hectares).

Éléonore is 100% owned by Newmont through its wholly owned Subsidiary, Goldcorp Canada Ltd.

Éléonore is a clastic sediment-hosted stockwork-disseminated gold deposit. Process facilities include a conventional mill which consists of a crushing and grinding circuit, flotation circuit, carbon-in-pulp circuits and an electrowinning plant where the gold is recovered and smelted to produce doré. The available mining fleet consists of 14 underground loaders and 11 haul trucks, each with 45 to 60 tonne payloads.

At 31 December 2022, Éléonore's gross property, plant and mine development was \$1,104 and reported 1.6 Moz of gold reserves. The project produced 215,000 ounces of gold in 2022, down 15% on 2021 primarily due to lower ore grade milled and lower mill throughput.

Unpredicted seismic activity presents an ongoing geotechnical risk at the Éléonore mine.



6.2 Newmont operations and projects *continued*

e) Peñasquito, Mexico

Peñasquito comprises two open pit mine sites, Peñasco and Chile Colorado, which are located approximately 200 km northeast of the city of Zacatecas, Mexico. There are 20 mining concessions for operations which cover 113,231 acres (45,823 hectares) and 60 mining concessions for exploration of 107,456 acres (43,486 hectares).

The property began production in 2009, with commercial production being achieved in 2010. Newmont obtained full ownership of the mine in 2019 after acquiring Goldcorp Inc. and holds the mine through its wholly owned Subsidiary Minera Peñasquito, S.A. de C.V. The surface rights are held by three ejidos (systems of communal landholding unique to Mexico): Ejido Cedros; Ejido Mazapil and Ejido Cerro Gordo. Peñasquito has signed land use agreements with each ejido, valid through 2035 and 2036, and the relevant private owners.

Newmont is required to sell 25% of its silver production from the Peñasquito mine to Wheaton Precious Metals Corporation. The Peñasquito mine is also subject to a 2% net smelter return royalty payable to Royal Gold Inc, and owes the Mexican Government a 7.5% mining royalty, a 0.5% environmental erosion fee as well as an ecological tax based on the volume of carbon emissions from fixed and mobile sources.

Peñasquito's gross property, plant and mine development at 31 December 2022 was \$6,003. In 2022, the operation produced 566,000 ounces of gold and 1,048,000 gold equivalent ounces of other metals. At 31 December 2022, Peñasquito reported 5.4 Moz of gold reserves, 346 Moz of silver reserves, 2,300 million pounds of lead and 5,540 million pounds of zinc.

The Peñasquito mine sources its water supply from the Cedros Aquifer which has limited and declining yield as it is located in a dry and arid area that is prone to drought, and also is relied upon by nearby communities as a water supply for drinking water and agriculture. As such, Peñasquito's water supply is subject to a significant degree of regulatory and community scrutiny. See also the risk factor in section 8.2(i)(7).

f) Merian, Suriname

Merian includes three open pit sites (with an additional site under development) located in Suriname, approximately 66 km south of Moengo and 30 km north of the Nassau Mountains, close to the French Guiana border. The project is comprised of one right of exploitation and four rights of exploration encompassing an area of 41,484 acres (16,788 hectares).

The project is 75% owned by Newmont Suriname, LLC, a wholly owned indirect Subsidiary of Newmont and 25% by Staatsolie Maatschappij Suriname N.V, a company wholly owned by the Republic of Suriname.

All of the gold mineralisation at Merian is closely associated with quartz veining within siltstone and sandstone formations. The available mining fleet consists of three shovels, three mining excavators and 36 haul trucks, each with 150 tonne payloads. Merian includes processing facilities that utilise a conventional gold mill, primary crusher and processing plant, consisting of a comminution plant, including gravity and cyanide leach processes, with recovery by carbon-in-leach, elution, electrowinning and induction furnace smelting to produce a gold doré product.

Merian's gross property, plant and mine development at 31 December 2022 was \$1,222. Merian produced 403,000 ounces of gold (302,000 attributable ounces of gold) in 2022 and reported 3.9 million attributable ounces of gold reserves at 31 December 2022.

The Merian operation is subject to political and economic risks given recent political instability in Suriname. Devaluation of the Surinamese dollar against the US dollar has resulted in an increase of the prices of certain goods and services in Suriname, including fuel, and the government recently passed a Value Added Tax on 1 January 2023 which has increased the cost of living. These trends may present risks for operations in Suriname.

The Merian mine is governed by a mineral agreement with the Republic of Suriname, which may be subject to future changes by the parliament of the day. The government also has a 25% equity stake in Merian which, if the government has insufficient funds or is unable to make its capital commitments, may impact the Merian operations.

g) Cerro Negro, Argentina

Cerro Negro is located in Southern Argentina about 400 km southwest of the coastal city of Comodoro Rivadavia. The project consists of the Eureka, Mariana Central, Mariana Norte and Emilia underground mine operations, as well as the San Marcos, Baja Negro and Silica Cap underground mines which are currently in development. The mineral tenure consists of 10 mining property titles encompassing 53,246 acres (21,548 hectares) and three exploration licenses, encompassing 13,193 acres (5,339 hectares).

The project is 100% owned by Newmont through its wholly owned Subsidiary, Oroplata S.A..

Deposits within the Cerro Negro mine operations are low sulfidation, epithermal gold/silver vein deposits. Cerro Negro's available underground mining fleet consists of 14 underground loaders, 17 underground haul trucks and eight surface haul trucks, each with 30 to 40 tonne payloads and additional auxiliary equipment as required. The processing plant facilities consist of a crushing plant, a grinding circuit, agitated leaching, countercurrent decantation, solution clarification, Merrill Crowe zinc precipitation and smelting to produce gold and silver doré bars that are shipped to a refinery for further processing.

At 31 December 2022, Cerro Negro's gross property, plant and mine development was \$1,974 and it reported 3.0 Moz of gold reserves. The operation produced 278,000 ounces of gold in 2022.

The Cerro Negro project is susceptible to the uncertain and unpredictable political and economic environment in Argentina and resulting labour unrest. In recent years, there have been work stoppages by miners represented by unions. The foreign currency controls enacted by Argentina's central bank have impacted the timing of Cerro Negro's ability to remit cash from gold sales and pay interest and principal portions of intercompany debt to Newmont.

6. Profile of the Newmont Group

6.2 Newmont operations and projects *continued*

h) Pueblo Viejo, Dominican Republic

Pueblo Viejo is an open pit conventional truck and shovel mining operation located approximately 100 km northwest of Santo Domingo, Dominican Republic. It is situated on the Montenegro Fiscal Reserve, an area specially designated by Presidential Decree for the leasing of minerals and mine development, which covers an area of approximately 19,756 acres (7,995 hectares) in aggregate.

The Pueblo Viejo mine is a joint venture with Barrick Gold Corporation. Newmont obtained a 40% interest in the operation when it acquired Goldcorp in 2019, and holds this interest through its wholly owned Subsidiary, Pueblo Viejo Dominicana Jersey 2 Limited. The project reached commercial production in January 2013 and full design capacity in 2014.

A special lease agreement with the Dominican State governs the development and operation of the mine, which provides a right to operate for a 25-year period, with the right to extend for 25 years and another 25-year extension by mutual agreement. The operation pays the Dominican Republic government a net smelter return royalty of 3.2% based on gross revenues for gold and silver, a net profits interest of 28.75%, a corporate income tax of 25%, a withholding tax on interest paid on loans and on payments abroad and other general tax obligations including a graduated minimum tax.

The Pueblo Viejo deposits consists of high sulfidation or acid sulphate epithermal gold, silver, copper and zinc mineralisation. Process facilities include a conventional mill which consists of a crushing and grinding circuit, autoclaves, and a carbon-in-leach circuit. A plant expansion and tailings storage facility is underway. A power plant commissioned by Pueblo Viejo in 2013 will provide long-term power supply while the project entered into a 10-year natural gas supply contract with AES Andres DR, S.A. in 2019. The available mining fleet consists of three shovels, five front loaders, 46 haul trucks, and seven drills.

At 31 December 2022, Newmont's attributable portion of Pueblo Viejo's gross property, plant and mine development was \$1,687, while its attributable portion of reported gold reserves was 8.2 Moz. Across 2022, Pueblo Viejo produced 285,000 attributable ounces of gold.

i) Yanacocha, Peru

Yanacocha is located approximately 604 km north of Lima and 48 km north of Cajamarca, Peru. It consists of four open pit mines, 171 mining concessions and encompasses 244,372 acres (98,894 hectares).

In 2022, Newmont completed the acquisition of Compañía de Minas Buenaventura S.A.A.'s 43.65% noncontrolling interest and Summit Global Management II VB's, a Subsidiary of Sumitomo, 5% noncontrolling interest in Yanacocha. At 31 December 2022, the Yanacocha project is 100% owned by Newmont through its wholly owned Subsidiary Minera Yanacocha S.R.L..

Yanacocha is an epithermal type deposit of high sulfidation hosted in volcanic rock formations. Gold is associated with ironoxides and pyrite, which is placed on leach pads. Yanacocha has four leach pads (La Quinua, Yanacocha, Carachugo and Maqui Maqui), three gold processing plants (Pampa Larga, Yanacocha Norte and La Quinua), and one limestone processing facility (China Linda). Yanacocha's available mining fleet consists of two shovels, four excavators, one loader and 31 haul trucks, each with 233 tonne payloads.

Yanacocha's gross property, plant and mine development at 31 December 2022 was \$5,892. Yanacocha produced 244,000 ounces of gold (230,000 attributable ounces of gold) in 2022 and reported 5.8 Moz of gold reserves and 1,530 million pounds of copper reserves at 31 December 2022.

Operations at Yanacocha are subject to risk of political and social unrest. For example, the mine has been the target of local and political community protests.

Yanacocha experienced rainfall above average historical levels in 2022, which resulted in significant water balance stress and active emergency management. The Peruvian Ministry of the Environment, in 2015 and 2017, also proposed modifications to the in-stream water quality criteria pursuant to which Yanacocha has been designing water treatment processes and infrastructure, which may continue to impact the project's operations.

In June 2023, Newmont announced the delay of the full-funds investment decision for the Yanacocha Sulfides project in Peru, currently estimated to occur in 2026. With the delay of the Yanacocha Sulfides project, management will focus on optimising allocation of funds to current operations, whilst also assessing execution options and project plans options, up to and including transitioning Yanacocha operations into full closure.



6.2 Newmont operations and projects continued

j) Boddington, Australia

The Boddington operations are located 130 km southeast of Perth in Western Australia, Australia. Operations comprise of two open pit sites adjacent to each other and the project area covers 52,506 acres (21,249 hectares) of mining tenure leased from the State of Western Australia, of which 26,910 acres (10,980 hectares) is subleased from the Worsley Joint Venturers (**Worsley JV**).⁴⁸ The total project area is comprised of multiple leases that expire between 2023 and 2041.

Boddington has been 100% owned by Newmont since June 2009 when it acquired the remaining one-third interest from AngloGold Ashanti Australia Limited.

Boddington consists of greenstone diorite hosted mineralisation. Exploration activities continue to develop the known reserve. The mine operates two pits (North and South Pits), utilising two electric rope shovels, a diesel-powered face shovel and a diesel hydraulic excavator as its prime ex-pit material movers with a fleet of 41 production autonomous haulage trucks. Boddington has a current capacity to mine approximately 150,000 to 250,000 tonnes of material per day. The milling plant includes a three-stage crushing facility (two primary crushers, six secondary crushers and four high-pressure grinding rolls), four ball mills, a flotation circuit and a carbon-in-leach circuit. The flotation circuit process recovers gold-copper concentrate before the material is then processed by a traditional carbon-in-leach circuit where the remaining gold is recovered to produce doré.

At 31 December 2022, Boddington's gross property, plant and mine development was \$4,612 and the project reported 10.6 Moz of gold reserves and 1,160 million pounds of copper reserves.

In 2022, Boddington produced 798,000 ounces of gold and 227,000 gold equivalent ounces of other metals. In addition, at the end of 2022, the Boddington mine reached a significant milestone by safely delivering more than 100 Mt with the "Autonomous Haulage System" fleet.

Boddington faces ongoing environmental challenges. Severe weather and heavy rainfall at Boddington caused delays and impacted productivity in the third quarter of calendar years 2021 and 2022. Equally, the risk of below average rainfall or drought has the potential to impact raw water supply for the site.

In addition, higher gold ounces sold and a favourable Australian dollar foreign currency exchange rate, partially offset by higher fuel and maintenance costs resulting from costs inflation, led to a decrease in costs applicable to sales per ounce of gold.

k) Tanami, Australia

The Tanami operations are located approximately 550 km northwest of Alice Springs in the Northern Territory, Australia. The underground mining infrastructure and operation is located at Dead Bullock Soak (**DBS**). Ore is transported from DBS by road train to a processing facility near the mining operations at the Granites.

Tanami is 100% owned by Newmont through its wholly owned Subsidiary, Newmont Tanami Pty Ltd.

The Newmont Tanami Operations are comprised of exploration licenses encompassing a total area of 1,620,332 acres (655,725 hectares) including 677,736 acres (274,270 hectares) relating to the Tobruk and Monza joint ventures entered into with Prodigy Gold, for which Newmont is the operator, and 11,025 acres (4,462 hectares) of mineral leases granted pursuant to the *Mineral Titles Act 2010* (NT). Additionally, Newmont operates through land access agreements pursuant to the *Aboriginal Land Rights Act 1976* (NT), with the Central Land Council who represent the affected Traditional Owners, local Warlpiri People.

Tanami consists of sediment hosted sheeted quartz vein mineralisation. Tanami, as an underground mining operation, has a fleet of 10 underground loaders and 22 haul trucks, each with 60 to 65 tonne payloads. Processing plant facilities currently consist of a crushing plant, a grinding circuit, gravity carbon in pulp tanks and a conventional tailings disposal facility.

At 31 December 2022, Tanami's gross property, plant and mine development was \$2,608 and it reported 5.7 Moz of gold reserves. Across calendar year 2022, Tanami produced 484,000 ounces of gold.

Significant rainfall and flooding have impacted Tanami and surrounding areas in early 2023, resulting in the closure of transportation routes leading to the Tanami mine. Tanami has previously completed the construction of a natural gas pipeline to transit gas for power generation as a substitute for truck deliveries of diesel fuel along roads which are regularly impacted due to seasonal rainfall. Newmont is also exploring other mitigation plans, such as pre-booking cargo planes for delivering supplies during the wet season and increasing inventories of critical reagents and parts.

48. The subleases from the Worsley JV expire immediately prior to the expiry of the relevant mining leases. Newmont holds rights to renew the subleases. The mining leases are renewable upon application to the State of Western Australia by the Worsley JV. As these mining leases are in their third term, renewal of these mining leases is at the discretion of the State. The subleases do not confer an express right to require the Worsley JV to seek application to renew the mining leases. Newmont is entitled to all gold and other non-bauxite mineralization conferred by the mining leases. The Worsley JV retains the rights to bauxite mineralization. The relationship between the Worsley JV bauxite operations and the Boddington gold operations are regulated through a cross-operation agreement. This agreement confers priority on the bauxite operations such that the bauxite/alumina mining operations of the Worsley JV will take priority over the gold mining operations and Newmont is required to take reasonable measures to conserve bauxite including by mining and stockpiling bauxite on behalf of the Worsley JV.

6. Profile of the Newmont Group

6.2 Newmont operations and projects *continued*

l) Ahafo, Ghana

Operation overview

The Ahafo operations are located in western Ghana near the towns of Kenyasi and Ntotroso in the Ahafo region of Ghana, approximately 290 km northwest from the national capital city of Accra.

Newmont acquired the Ahafo project in early 2002 and began commercial gold production in 2006. The project is 100% owned by Newmont through its wholly owned indirect Subsidiary, Newmont Ghana Gold Ltd.

Ahafo South

The Ahafo South mine is composed of three orogenic gold deposits that have oxide and primary mineralisation. Gold occurs primarily in pyrite and secondarily as native gold in quartz veins. Ahafo South currently operates a mill, two active open pits (Subika and Awonsu) and an underground operation. The available mining fleet for surface mining consists of three shovels and 36 haul trucks, each truck with a 141 tonne payload. The available mining fleet for underground mining consists of eight underground loaders and 12 haul trucks, with truck payloads ranging from 50 to 55 tonnes.

The daily production rate at the Ahafo South mine is approximately 95,000 tonnes. The current processing plant consists of two crushing plants, two grinding circuits, carbon-in-leach circuits, elution circuit, counter current decantation circuit, a tailings disposal facility and the use of the Akyem analytical laboratory. The processing plant has capacity to process approximately 11 Mt per year.

Ahafo South's gross property, plant and mine development at 31 December 2022 was \$3,052. Ahafo South produced 574,000 ounces of gold in 2022.

As of 31 December 2022, Ahafo South reported 5.7 Moz of gold reserves.

Ahafo North

In July 2021, the Newmont Board approved full funding for the Ahafo North project (located approximately 30 km from the Ahafo South operations) which will add four open pit mines and a stand-alone mill to the Ahafo project.

As of 31 December 2022, Ahafo North reported approximately 3.8 Moz of gold reserves.

Over a 13-year mine life, the Ahafo North project will deliver value through the processing of over 3 Moz of gold. Capital costs for the project are estimated to be between \$950 and \$1,050 with an expected commercial production date in late 2025. Development capital costs (excluding capitalised interest) since approval were \$283, of which \$145 and \$71 related to 2022 and the six months ended 30 June 2023 respectively.

m) Akyem, Ghana

Akyem is located in the Birim North District of the Eastern Region of Ghana, approximately 125 km northwest from the national capital city of Accra. The project is an open pit mining operation comprised of two mining leases issued under the Ghanaian Mining Act, encompassing an area of approximately 16,000 acres (6,000 hectares).

Newmont obtained the mining lease for Akyem in 2010 and began commercial production in 2013. The project is 100% owned by Newmont through its wholly owned Subsidiary, Newmont Golden Ridge Limited.

The Akyem mine is an orogenic gold deposit that has oxide and primary mineralisation. Process facilities include a crushing plant, a SAG and ball milling circuit, carbon-in-leach circuit, elution circuit and bullion smelting facilities. The available mining fleet consists of four excavators made up of two front end shovels and two backhoe excavators and 21 136 tonne haul trucks.

Akyem's gross property, plant and mine development at 31 December 2022 was \$1,697.

Akyem produced 420,000 ounces of gold in 2022 and reported 1.5 Moz of gold reserves at 31 December 2022.



6.2 Newmont operations and projects continued

n) Nevada, United States

Nevada Gold Mines (**NGM**) is a collection of mines located in Elko, Nevada, USA. In aggregate, the operation comprises 180,921 acres (73,217 hectares). All sites at NGM contain open pit operations, while the Cortez, Carlin and Turquoise Ridge sites also include underground operations.

Newmont owns a 38.5% share in NGM through its wholly owned Subsidiary, Nevada Gold Mines LLC after entering into a joint venture agreement with Barrick Gold Corporation in July 2019 to combine each party's mining operations. Barrick Gold Corporation operates NGM.

NGM owns or controls (through leases, fee ownership and unpatented mining claims) all minerals and surface area within the boundaries of the current NGM mining operations. The long-term leases extend for at least the anticipated mine life of those deposits. In addition, NGM pays a net smelter royalty equivalent to 16.2% of the mineral production, NGM wholly owns or controls the remainder of the Gold Quarry mineral rights, in some cases subject to additional royalties. With respect to certain smaller deposits in Nevada, NGM is obligated to pay royalties on production to third parties that vary from 1% to 8% of production.

In Nevada, mining taxes are assessed on up to 5% of net proceeds of a mine. During 2021, the Nevada legislature enacted a new excise tax which is assessed up to 1.1% of gross revenues, and NGM may be further impacted by proposals before the State of Nevada to amend the State Constitution to increase mining taxes.

NGM comprises several different mines. At Cortez, mineralisation is sedimentary rock-hosted and consists of submicron to micrometre sized gold particles and gold in solid solution in pyrite. Refractory ore is transported to Carlin for processing. Phoenix is a skarn-hosted polymetallic massive sulphide replacement deposit. The Phoenix mill produces a gravity gold concentrate and a copper/gold flotation concentrate and recovers additional gold from cyanide leaching of the flotation tails. Carlin, Turquoise Ridge, and Long Canyon are a sediment-hosted disseminated gold deposit. Additionally, at Long Canyon, oxide ore with suitable cyanide solubility is treated on a heap leach pad. Gold recovered from the leach pad is transferred as gold-bearing carbon to Carlin for refining and shipment.

Each site has its own processing facilities which include:

- at Cortez an oxide mill, which consists of a crushing and grinding circuit and carbon-in-leach circuit, and two heap leach pads;
- at Carlin an autoclave, two roasters, an oxide mill/flotation circuit and four heap leach pads;
- at Turquoise Ridge the Sage autoclave, an oxide mill, and three heap leach pads;
- at Phoenix a flotation mill, a carbon-in-leach plant, a copper leach pad and a solvent extraction electrowinning (**SX/EW**) plant; and
- at Long Canyon, a heap leach pad.

NGM has a current capacity across all sites to mine approximately 340,000 tonnes of material per day. The milling facilities undergo routine maintenance each year with process improvements implemented as the projects are identified and approved. Power is either purchased in the open market or supplied by the power plants owned and operated by NGM.

Newmont's share of NGM's gross property, plant and mine development at 31 December 2022 was \$8,081, while its portion of the gold reserves was 18.6 Moz. In 2022, NGM produced 1,169,000 attributable ounces of gold.

6.3 Production

In calendar year 2022, Newmont produced 6.0 million attributable ounces of gold and 1.3 million attributable gold equivalent ounces from copper, silver, lead and zinc.

Newmont's historical production and costs for the period 2020 – 2022 is set out in the table below:

	2022	2021	2020
Consolidated gold production (thousands of ounces)	5,786	5,884	5,824
Attributable gold production (thousands of ounces) ¹	5,956	5,971	5,905
Average realised gold price (\$ per ounce)	\$1,792	\$1,788	\$1,775

Note:

1. Attributable production, mineral reserves or mineral resources reflect Newmont's percentage ownership at each individual property. Attributable production represents the metal that will be credited to Newmont, with the remaining production allocated to the other owner(s). Consolidated (or 100%) would represent the total production, mineral reserves or mineral resources across all sites, regardless of the ownership share.

See the cautionary statement in section 6.2.

6. Profile of the Newmont Group

6.4 Resources and reserves

The information contained in this section 6.4 for Newmont was prepared in accordance with the requirements of the United States Securities and Exchange Commission in Subpart 1300.

Accordingly, the resources and reserves estimates for Newmont were prepared in accordance with Subpart 1300 and do not purport to be reported in accordance with or otherwise compliant with the JORC Code.

Because the estimates have not been prepared in accordance with the JORC Code, they are classified as Foreign Estimates under the ASX Listing Rules. If the Scheme is implemented, Newcrest will apply to be delisted from the Official List of the ASX and Newmont intends to apply for admission to the Official List of the ASX as a Foreign Exempt Listing. If admitted as a Foreign Exempt Listing, Newmont will be exempt from complying with ASX Listing Rule 5.12 and will instead comply with NYSE Listing Rules in respect of resources and reserves reporting. As such, Newmont has no intention to present the foreign estimates in accordance with the JORC Code or otherwise to verify them for this purpose.

In relation to the reliability of the Newmont Foreign Estimates contained in this Scheme Booklet, it should be noted that:

- the Newmont Foreign Estimates are not reported in accordance with the JORC Code;
- a Competent Person has not done sufficient work to classify the Foreign Estimates as Mineral Resources or Ore Reserves in accordance with the JORC Code;
- it is currently uncertain whether, following evaluation and/or further exploration work, the Newmont Foreign Estimates will be able to be reported as Mineral Resources or Ore Reserves in accordance with the JORC Code;
- the Newmont Foreign Estimates have not been published with all the supporting data and such Newmont Foreign Estimates have not been verified by independent third parties;
- Newmont's mineral reserves are reported on an attributable basis; and
- Newmont's mineral resources are reported exclusive of reserves and on an attributable basis.

For further information about the reporting standards applicable to Newmont, see section 11.12(b).

a) Proven and probable reserves as at 31 December 2022

Table 6.4.1: Newmont's proven and probable gold reserves as at 31 December 2022

Gold reserves at 31 December 2022¹

Deposits/Districts	Newmont Share	Proven reserves			Probable reserves			Proven and probable reserves			Metallurgical Recovery ³
		Tonnage ² (000 tonnes)	Grade (g/tonne)	Ounces ³ (000)	Tonnage ² (000 tonnes)	Grade (g/tonne)	Ounces ³ (000)	Tonnage ² (000 tonnes)	Grade (g/tonne)	Ounces ³ (000)	
CC&V Open Pits	100%	49,300	0.39	620	12,000	0.31	120	61,400	0.37	740	57%
CC&V Leach Pads ^{4,5}	100%	—	—	—	32,600	0.78	820	32,600	0.78	820	56%
Total CC&V, Colorado		49,300	0.39	620	44,600	0.66	940	94,000	0.52	1,560	56%
Musselwhite, Canada ⁶	100%	3,400	5.48	590	7,000	5.89	1,320	10,400	5.76	1,920	96%
Porcupine Underground ⁷	100%	1,800	8.50	500	700	8.47	190	2,500	8.49	690	92%
Porcupine Open Pit ⁸	100%	2,600	1.60	130	31,900	1.44	1,480	34,500	1.46	1,610	93%
Total Porcupine, Canada		4,400	4.44	630	32,600	1.59	1,670	37,000	1.93	2,300	93%
Éléonore, Canada ⁹	100%	1,900	5.11	310	7,400	5.25	1,260	9,400	5.22	1,570	92%
Peñasquito, Mexico ¹⁰	100%	104,500	0.58	1,960	212,000	0.51	3,450	316,500	0.53	5,410	69%
Yanacocha Open Pits ¹¹	100%	27,500	0.71	630	119,000	0.72	2,750	146,500	0.72	3,380	57%
Yanacocha Underground ¹²	100%	—	—	—	12,300	6.06	2,400	12,300	6.06	2,400	97%
Total Yanacocha, Peru ¹³		27,500	0.71	630	131,300	1.22	5,140	158,800	1.13	5,780	73%
Merian, Suriname ¹⁴	75%	31,000	1.16	1,150	73,800	1.16	2,750	104,800	1.16	3,900	93%
Cerro Negro, Argentina ¹⁵	100%	1,600	9.46	500	7,800	10.13	2,530	9,400	10.02	3,030	95%
Pueblo Viejo Open Pits	40%	23,500	2.29	1,730	55,000	2.15	3,800	78,500	2.19	5,530	90%
Pueblo Viejo Stockpiles ¹⁶	40%	—	—	—	38,200	2.17	2,670	38,200	2.17	2,670	90%
Total Pueblo Viejo, Dominican Republic ^{17,18}		23,500	2.29	1,730	93,100	2.16	6,470	116,600	2.19	8,200	90%
NuevaUnión, Chile ^{19,20}	50%	—	—	—	341,100	0.47	5,110	341,100	0.47	5,110	66%
Norte Abierto, Chile ^{20,21}	50%	—	—	—	598,800	0.60	11,620	598,800	0.60	11,620	74%
Boddington Open Pit	100%	237,400	0.68	5,190	209,300	0.64	4,300	446,700	0.66	9,490	85%
Boddington Stockpiles ¹⁶	100%	2,000	0.71	50	76,200	0.43	1,040	78,300	0.43	1,090	80%
Total Boddington, Western Australia ²²		239,400	0.68	5,240	285,500	0.58	5,350	524,900	0.63	10,580	84%

TABLE 6.4.1 CONTINUES ON NEXT PAGE

6.4 Resources and reserves *continued*Table 6.4.1: Newmont's proven and probable gold reserves as at 31 December 2022 *continued**Gold reserves at 31 December 2022¹ continued*

Deposits/Districts	Newmont Share	Proven reserves			Probable reserves			Proven and probable reserves			
		Tonnage ² (000 tonnes)	Grade (g/tonne)	Ounces ³ (000)	Tonnage ² (000 tonnes)	Grade (g/tonne)	Ounces ³ (000)	Tonnage ² (000 tonnes)	Grade (g/tonne)	Ounces ³ (000)	Metallurgical Recovery ³
Tanami, Northern Territory ²³	100%	11,300	5.05	1,840	21,600	5.49	3,820	33,000	5.34	5,660	98%
Ahafo South Open Pits ²⁴	100%	9,000	2.42	700	38,600	1.67	2,070	47,600	1.81	2,770	90%
Ahafo South Underground ²⁵	100%	9,300	3.68	1,100	13,300	2.62	1,130	22,600	3.06	2,230	94%
Ahafo South Stockpiles ¹⁶	100%	22,100	0.91	640	—	—	—	22,100	0.91	640	90%
Total Ahafo South, Ghana		40,400	1.89	2,450	51,900	1.92	3,200	92,300	1.90	5,650	92%
Ahafo North, Ghana ²⁶	100%	—	—	—	50,100	2.37	3,820	50,100	2.37	3,820	91%
Akyem Open Pit ²⁷	100%	14,300	1.56	720	8,000	1.82	470	22,300	1.66	1,190	91%
Akyem Stockpiles ¹⁶	100%	11,900	0.71	270	—	—	—	11,900	0.71	270	92%
Total Akyem, Ghana		26,200	1.18	990	8,000	1.82	470	34,200	1.33	1,460	91%
NGM Open Pits	38.5%	8,300	1.73	460	151,100	0.96	4,650	159,400	1.00	5,110	76%
NGM Stockpiles ¹⁶	38.5%	10,100	2.05	670	15,000	2.51	1,210	25,100	2.32	1,880	79%
NGM Underground	38.5%	13,700	9.72	4,290	27,500	8.26	7,320	41,300	8.75	11,610	88%
Total NGM, Nevada ²⁸		32,100	5.24	5,410	193,700	2.12	13,180	225,800	2.56	18,590	84%
Total Gold		596,700	1.25	24,050	2,160,400	1.04	72,100	2,757,100	1.09	96,140	83%

Notes:

- Gold reserves, at sites in which Newmont is the operator for 2022 were estimated at a gold price of \$1,400 per ounce, unless otherwise noted. Reserves provided by other operators may use pricing that differs. Amounts presented may not recalculate in total due to rounding.
- Tonnages include allowances for losses resulting from mining methods. Tonnages are rounded to the nearest 100,000.
- Ounces are estimates of metal contained in ore tonnages and do not include allowances for processing losses. Metallurgical recovery rates represent the estimated amount of metal to be recovered through metallurgical extraction processes. Ounces may not recalculate as they are rounded to the nearest 10,000.
- Cut-off grades utilised in 2022 reserves were as follows: leach material not less than 0.10 grams per tonne.
- Leach pad material is the material on leach pads at the end of the year from which gold remains to be recovered. In-process reserves are reported separately where ounces exceed 100,000 and are greater than 5% of the total site-reported reserves.
- Cut-off grade utilised in 2022 reserves not less than 3.10 grams per tonne.
- Cut-off grade utilised in 2022 reserves not less than 5.00 grams per tonne.
- Cut-off grade utilised in 2022 reserves not less than 0.51 grams per tonne.
- Cut-off grade utilised in 2022 reserves not less than 4.00 grams per tonne.
- Gold cut-off grade varies with level of silver, lead and zinc credits.
- Gold cut-off grades utilised in 2022 reserves were as follows: oxide leach material not less than 0.12 grams per tonne and refractory mill material not less than 1.26 grams per tonne.
- Gold cut-off grades utilised in 2022 were as follows: oxide mill material not less than 2.63 grams per tonne and refractory mill material varies with level of copper and silver credits.
- In 2022, Newmont increased its ownership interest in Yanacocha to 100% by acquiring Buenaventura's 43.65% noncontrolling interest and Sumitomo's 5% noncontrolling interest. Refer to Note 1 to the Newmont consolidated financial statements for the year ended 31 December 2022 for further information.
- Cut-off grade utilised in 2022 reserves not less than 0.31 grams per tonne.
- Cut-off grade utilised in 2022 reserves not less than 4.30 grams per tonne.
- Stockpiles are comprised primarily of material that has been set aside to allow processing of higher grade material in the mills. Stockpiles increase or decrease depending on current mine plans. Stockpile reserves are reported separately where ounces exceed 100,000 and are greater than 5% of the total site-reported reserves.
- Amounts presented herein have been rounded to the nearest 10,000 for ounces and 100,000 for tonnes and therefore may not agree to the respective Technical Report Summaries provided for certain properties as provided under exhibit 96 of the Newmont FY22 Annual Report.
- The Pueblo Viejo mine, which is 40% owned by Newmont, is accounted for as an equity method investment. Reserve estimates provided by Barrick, the operator of Pueblo Viejo.
- Project is currently undeveloped. Reserve estimates provided by the NuevaUnión joint venture.
- Currently included in Corporate and Other in Note 3 of the Newmont's consolidated financial statements for the year ended 31 December 2022.
- Project is currently undeveloped. Reserve estimates provided by the Norte Abierto joint venture.
- Gold cut-off grade varies with level of copper credits.
- Cut-off grade utilised in 2022 reserves not less than 2.30 grams per tonne.
- Cut-off grade utilised in 2022 reserves not less than 0.60 grams per tonne.
- Cut-off grade utilised in 2022 reserves not less than 1.60 grams per tonne.
- Cut-off grade utilised in 2022 reserves not less than 0.56 grams per tonne.
- Cut-off grade utilised in 2022 reserves not less than 0.52 grams per tonne.
- Reserve estimates provided by Barrick, the operator of the NGM joint venture.

6. Profile of the Newmont Group

6.4 Resources and reserves *continued*

Table 6.4.2: Newmont's proven and probable copper reserves as at 31 December 2022

*Copper reserves at 31 December 2022*¹

Deposits/Districts	Newmont Share	Proven reserves			Probable reserves			Proven and probable reserves			
		Tonnage ² (000 tonnes)	Grade (Cu%)	Pounds ³ (millions)	Tonnage ² (000 tonnes)	Grade (Cu%)	Pounds ³ (millions)	Tonnage ² (000 tonnes)	Grade (Cu%)	Pounds ³ (millions)	Metallurgical Recovery ³
Yanacocha Open Pits and Underground, Peru ^{4,5}	100%	—	—	—	111,100	0.63%	1,530	111,100	0.63%	1,530	83%
NuevaUnión, Chile ^{6,7}	50%	—	—	—	1,118,000	0.40%	9,800	1,118,000	0.40%	9,800	88%
Norte Abierto, Chile ^{7,8}	50%	—	—	—	598,800	0.22%	2,890	598,800	0.22%	2,890	87%
Boddington Open Pit, Western Australia ⁹	100%	237,400	0.10%	510	209,300	0.11%	500	446,700	0.10%	1,010	82%
Boddington Stockpiles, Western Australia ¹⁰	100%	2,000	0.13%	10	76,200	0.09%	150	78,300	0.09%	150	74%
NGM, Nevada ¹¹	38.5%	7,000	0.16%	30	81,700	0.16%	300	88,700	0.16%	320	65%
Total Copper		246,400	0.10%	540	2,195,200	0.31%	15,160	2,441,500	0.29%	15,710	86%

Notes:

- Copper reserves, at sites in which Newmont is the operator, for 2022 were estimated at a copper price of \$3.50 per pound. Reserves provided by other operators may use pricing that differs. Amounts presented may not recalculate in total due to rounding.
- Tonnages include allowances for losses resulting from mining methods. Tonnages are rounded to nearest 100,000.
- Pounds are estimates of metal contained in ore tonnages and do not include allowances for processing losses. Metallurgical recovery rates represent the estimated amount of metal to be recovered through metallurgical extraction processes. Pounds may not recalculate as they are rounded to the nearest 10 million.
- Reserve estimates relate to the undeveloped Yanacocha Sulfides project. Copper cut-off grade varies with level of gold and silver credits.
- In 2022, Newmont increased its ownership interest in Yanacocha to 100% by acquiring Buenaventura's 43.65% noncontrolling interest and Sumitomo's 5% noncontrolling interest. Refer to Note 1 of Newmont's consolidated financial statements for the year ended 31 December 2022 for further information.
- Project is currently undeveloped. Reserve estimates provided by the NuevaUnión joint venture.
- Currently included in Corporate and Other in Note 3 of Newmont's consolidated financial statements for the year ended 31 December 2022.
- Project is currently undeveloped. Reserve estimates provided by the Norte Abierto joint venture.
- Copper cut-off grade varies with level of gold credits.
- Stockpiles are comprised primarily of material that has been set aside to allow processing of higher grade material in the mills. Stockpiles increase or decrease depending on current mine plans. Stockpiles are reported separately where pounds exceed 100 million and are greater than 5% of the total site reported reserves.
- Reserve estimates provided by Barrick, the operator of the NGM joint venture.

6.4 Resources and reserves *continued*

Table 6.4.3: Newmont's proven and probable silver reserves as at 31 December 2022

Silver reserves at 31 December 2022¹

Deposits/Districts	Newmont Share	Proven reserves			Probable reserves			Proven and probable reserves			Metallurgical Recovery ³
		Tonnage ² (000 tonnes)	Grade (g/tonne)	Ounces ³ (000)	Tonnage ² (000 tonnes)	Grade (g/tonne)	Ounces ³ (000)	Tonnage ² (000 tonnes)	Grade (g/tonne)	Ounces ³ (000)	
Peñasquito Open Pits, Mexico ⁴	100%	103,900	38.00	126,990	184,500	33.04	196,020	288,500	34.82	323,000	86%
Peñasquito Stockpiles, Mexico ⁵	100%	500	37.88	660	27,500	25.33	22,390	28,000	25.57	23,050	86%
Yanacocha Open Pits and Underground, Peru ⁶	100%	—	—	—	93,400	19.90	59,760	93,400	19.90	59,760	54%
Yanacocha Stockpiles and Leach Pads, Peru ^{5,7}	100%	2,800	31.48	2,820	93,600	8.04	24,190	96,400	8.71	27,010	13%
Total Yanacocha, Peru ⁸		2,800	31.48	2,820	187,000	13.96	83,950	189,800	14.22	86,770	41%
Cerro Negro, Argentina ⁹	100%	1,600	74.72	3,940	7,800	62.31	15,550	9,400	64.47	19,490	75%
Pueblo Viejo, Dominican Republic, Open Pits ¹⁰	40%	23,500	12.94	9,780	55,000	12.84	22,680	78,500	12.87	32,460	65%
Pueblo Viejo, Dominican Republic, Stockpiles ^{5,10}	40%	—	—	—	38,200	15.10	18,520	38,200	15.10	18,520	65%
Total Pueblo Viejo, Dominican Republic ¹¹		23,500	12.94	9,780	93,100	13.76	41,200	116,600	13.60	50,980	65%
NuevaUnión, Chile ^{12,13}	50%	—	—	—	1,118,000	1.31	47,170	1,118,000	1.31	47,170	66%
Norte Abierto, Chile ^{13,14}	50%	—	—	—	598,800	1.52	29,340	598,800	1.52	29,340	74%
NGM, Nevada ¹⁵	38.5%	5,300	7.46	1,280	60,100	6.24	12,060	65,500	6.34	13,340	38%
Total Silver		137,800	32.84	145,460	2,276,900	6.12	447,680	2,414,600	7.64	593,140	74%

Notes:

- Silver reserves, at sites in which Newmont is the operator, for 2022 were estimated at a silver price of \$20 per ounce. Reserves provided by other operators may use pricing that differs. Amounts presented may not recalculate in total due to rounding.
- Tonnages include allowances for losses resulting from mining methods. Tonnages are rounded to nearest 100,000.
- Ounces are estimates of metal contained in ore tonnages and do not include allowances for processing losses. Metallurgical recovery rates represent the estimated amount of metal to be recovered through metallurgical extraction processes. Ounces may not recalculate as they are rounded to the nearest 10,000.
- Silver cut-off grade varies with gold, lead and zinc credits.
- Stockpiles are comprised primarily of material that has been set aside to allow processing of higher grade material in the mills. Stockpiles increase or decrease depending on current mine plans. Stockpile reserves are reported separately where ounces exceed 100,000 and are greater than 5% of the total site-reported reserves.
- Silver cut-off grade varies with gold and copper credits.
- Leach pad material is the material on leach pads at the end of the year from which silver remains to be recovered. In-process reserves are reported separately where ounces exceed 100,000 and are greater than 5% of the total site-reported reserves.
- In 2022, Newmont increased its ownership interest in Yanacocha to 100% by acquiring Buenaventura's 43.65% noncontrolling interest and Sumitomo's 5% noncontrolling interest. Refer to Note 1 of Newmont's consolidated financial statements for the year ended 31 December 2022 for further information.
- Silver cut-off grade varies with gold credits.
- The Pueblo Viejo mine, which is 40% owned by Newmont, is accounted for as an equity method investment. Reserve estimates provided by Barrick, the operator of Pueblo Viejo.
- Amounts presented herein have been rounded to the nearest 10,000 for ounces and 100,000 for tonnes and therefore may not agree to the respective Technical Report Summaries provided for certain properties as provided under exhibit 96 of the Newmont 2022 Annual Report for the year ended 31 December 2022.
- Project is currently undeveloped. Reserve estimates provided by the NuevaUnión joint venture.
- Currently included in Corporate and Other in Note 3 of Newmont's consolidated financial statements for the year ended 31 December 2022.
- Project is currently undeveloped. Reserve estimates provided by the Norte Abierto joint venture.
- Reserve estimates provided by Barrick, the operator of the NGM joint venture.

6. Profile of the Newmont Group

6.4 Resources and reserves *continued*

Table 6.4.4: Newmont's proven and probable lead reserves as at 31 December 2022

*Lead reserves at 31 December 2022*¹

Deposits/Districts	Newmont Share	Proven reserves			Probable reserves			Proven and probable reserves			
		Tonnage ² (000 tonnes)	Grade (Pb%)	Pounds ³ (millions)	Tonnage ² (000 tonnes)	Grade (Pb%)	Pounds ³ (millions)	Tonnage ² (000 tonnes)	Grade (Pb%)	Pounds ³ (millions)	Metallurgical Recovery ³
Peñasquito Open Pits, Mexico ⁴	100%	103,900	0.36%	830	184,500	0.31%	1,270	288,500	0.33%	2,090	72%
Peñasquito Stockpiles, Mexico ⁵	100%	500	0.16%	—	27,500	0.33%	200	28,000	0.33%	200	72%
Total Lead		104,500	0.36%	830	212,000	0.31%	1,470	316,500	0.33%	2,300	72%

Notes:

- Lead reserves for 2022 were estimated at a lead price of \$1.00 per pound. Amounts presented may not recalculate in total due to rounding.
- Tonnages include allowances for losses resulting from mining methods. Tonnages are rounded to nearest 100,000.
- Pounds are estimates of metal contained in ore tonnages and do not include allowances for processing losses. Metallurgical recovery rates represent the estimated amount of metal to be recovered through metallurgical extraction processes. Pounds may not recalculate as they are rounded to the nearest 10 million.
- Lead cut-off grade varies with level of gold, silver and zinc credits.
- Stockpiles are comprised primarily of material that has been set aside to allow processing of higher grade material in the mills. Stockpiles increase or decrease depending on current mine plans. Stockpile reserves are reported separately where pounds exceed 100 million and are greater than 5% of the total site-reported reserves.

Table 6.4.5: Newmont's proven and probable zinc reserves as at 31 December 2022

*Zinc reserves at 31 December 2022*¹

Deposits/Districts	Newmont Share	Proven reserves			Probable reserves			Proven and probable reserves			
		Tonnage ² (000 tonnes)	Grade (Zn%)	Pounds ³ (millions)	Tonnage ² (000 tonnes)	Grade (Zn%)	Pounds ³ (millions)	Tonnage ² (000 tonnes)	Grade (Zn%)	Pounds ³ (millions)	Metallurgical Recovery ³
Peñasquito Open Pits, Mexico ⁴	100%	103,900	0.94%	2,160	184,500	0.76%	3,080	288,500	0.82%	5,240	81%
Peñasquito Stockpiles, Mexico ⁵	100%	500	0.95%	10	27,500	0.46%	280	28,000	0.47%	290	81%
Total Zinc		104,500	0.94%	2,180	212,000	0.72%	3,360	316,500	0.79%	5,540	81%

Notes:

- Zinc reserves for 2022 were estimated at a zinc price of \$1.20 per pound. Amounts presented may not recalculate in total due to rounding.
- Tonnages include allowances for losses resulting from mining methods. Tonnages are rounded to nearest 100,000.
- Pounds are estimates of metal contained in ore tonnages and do not include allowances for processing losses. Metallurgical recovery rates represent the estimated amount of metal to be recovered through metallurgical extraction processes. Pounds may not recalculate as they are rounded to the nearest 10 million.
- Zinc cut-off grade varies with level of gold, silver and lead credits.
- Stockpiles are comprised primarily of material that has been set aside to allow processing of higher grade material in the mills. Stockpiles increase or decrease depending on current mine plans. Stockpile reserves are reported separately where pounds exceed 100 million and are greater than 5% of the total site-reported reserves.

Table 6.4.6: Newmont's proven and probable molybdenum reserves as at 31 December 2022

*Molybdenum reserves at 31 December 2022*¹

Deposits/Districts	Newmont Share	Proven reserves			Probable reserves			Proven and probable reserves			
		Tonnage ² (000 tonnes)	Grade (Mo%)	Pounds ³ (millions)	Tonnage ² (000 tonnes)	Grade (Mo%)	Pounds ³ (millions)	Tonnage ² (000 tonnes)	Grade (Mo%)	Pounds ³ (millions)	Metallurgical Recovery ³
NuevaUnión, Chile ⁴	50%	—	—	—	776,900	0.02%	270	776,900	0.02%	270	48%
Total Molybdenum		—	—	—	776,900	0.02%	270	776,900	0.02%	270	48%

Notes:

- Reserves estimates were estimated based on prices set by the NuevaUnión joint venture. The project is currently undeveloped.
- Tonnages include allowances for losses resulting from mining methods. Tonnages are rounded to nearest 100,000.
- Pounds are estimates of metal contained in ore tonnages and do not include allowances for processing losses. Metallurgical recovery rates represent the estimated amount of metal to be recovered through metallurgical extraction processes. Pounds may not recalculate as they are rounded to the nearest 10 million.
- Currently included in Corporate and Other in Note 3 of Newmont's consolidated financial statements for the year ended 31 December 2022.

See the cautionary statement in section 6.2.

6.4 Resources and reserves continued

b) Measured, indicated and inferred resources as at 31 December 2022

Table 6.4.7: Newmont's measured, indicated and inferred gold resources as at 31 December 2022

Gold resources at 31 December 2022^{1,2}

Deposits/ Districts	Newmont Share	Measured resources			Indicated resources			Measured and indicated resources			Inferred resources			Metallurgical Recovery ³
		Tonnage (000 tonnes)	Grade (g/tonne)	Ounces (000)	Tonnage (000 tonnes)	Grade (g/tonne)	Ounces (000)	Tonnage (000 tonnes)	Grade (g/tonne)	Ounces (000)	Tonnage (000 tonnes)	Grade (g/tonne)	Ounces (000)	
CC&V, Colorado	100%	79,700	0.38	980	42,300	0.32	440	122,000	0.36	1,420	32,200	0.34	350	59%
Musselwhite, Canada	100%	1,300	3.92	170	2,600	3.93	330	3,900	3.93	490	3,000	4.15	410	95%
Porcupine Underground	100%	300	6.69	70	1,000	8.64	270	1,300	8.15	340	1,800	8.08	480	92%
Porcupine Open Pit	100%	200	0.51	—	73,000	1.53	3,600	73,200	1.53	3,600	66,000	1.36	2,890	91%
Total Porcupine, Canada		500	4.36	70	73,900	1.63	3,860	74,500	1.64	3,940	67,900	1.54	3,370	91%
Éléonore, Canada	100%	400	5.05	70	2,100	5.10	350	2,500	5.09	420	2,600	5.45	460	92%
Peñasquito, Mexico	100%	47,400	0.25	390	263,500	0.26	2,190	311,000	0.26	2,570	84,700	0.41	1,110	69%
Noche Buena, Mexico	50%	—	—	—	19,900	0.37	240	19,900	0.37	240	1,600	0.21	10	50%
Coffee, Canada	100%	—	—	—	53,900	1.23	2,140	53,900	1.23	2,140	7,200	1.01	230	80%
Galore Creek, Canada ⁴	50%	212,800	0.29	2,010	385,600	0.22	2,710	598,400	0.25	4,720	118,900	0.19	720	75%
Conga, Peru ⁵	100%	—	—	—	693,800	0.65	14,590	693,800	0.65	14,590	230,500	0.39	2,880	75%
Yanacocha Open Pit	100%	13,500	0.38	170	114,900	0.42	1,570	128,400	0.42	1,730	189,700	0.79	4,830	66%
Yanacocha Underground	100%	500	4.07	70	6,200	4.70	940	6,700	4.65	1,010	3,400	4.99	550	97%
Total Yanacocha, Peru ⁵		14,100	0.52	240	121,100	0.64	2,510	135,100	0.63	2,740	193,100	0.87	5,380	72%
Merian, Suriname	75%	5,600	0.99	180	35,300	1.26	1,430	40,900	1.22	1,610	37,000	0.86	1,020	89%
Cerro Negro Underground	100%	200	6.11	30	1,500	7.33	360	1,700	7.22	390	5,700	6.19	1,140	95%
Cerro Negro Open Pit	100%	1,200	3.28	130	1,200	3.15	120	2,400	3.22	250	300	2.46	20	90%
Total Cerro Negro, Argentina	100%	1,400	3.60	160	2,700	5.49	480	4,100	4.86	630	6,000	6.00	1,160	94%
Pueblo Viejo, Dominican Republic ^{6,7}	40%	7,300	1.43	340	33,200	1.51	1,610	40,600	1.49	1,950	3,000	1.77	170	88%
NuevaUnión, Chile ⁸	50%	4,800	0.47	70	118,300	0.59	2,260	123,100	0.59	2,330	239,800	0.40	3,050	68%
Norte Abierto, Chile ⁹	50%	77,200	0.61	1,510	596,900	0.49	9,320	674,200	0.50	10,820	369,600	0.37	4,360	76%
Boddington, Western Australia	100%	92,800	0.55	1,630	167,400	0.54	2,900	260,200	0.54	4,530	2,800	0.51	50	83%
Tanami Open Pit	100%	9,400	1.67	500	23,800	1.47	1,120	33,200	1.53	1,630	4,200	1.13	150	90%
Tanami Underground	100%	1,700	3.26	180	5,400	4.29	750	7,100	4.04	920	8,800	5.19	1,460	97%
Total Tanami, Northern Territory	100%	11,000	1.91	680	29,200	1.99	1,870	40,200	1.97	2,550	13,000	3.88	1,620	94%
Ahafo South	100%	200	0.56	—	20,000	1.09	700	20,200	1.09	710	10,200	1.29	420	86%
Ahafo Underground	100%	—	—	—	24,700	3.53	2,810	24,700	3.53	2,810	11,000	3.44	1,220	92%
Total Ahafo South, Ghana		200	0.56	—	44,700	2.44	3,510	44,900	2.43	3,510	21,200	2.41	1,640	91%
Ahafo North Open Pits, Ghana	100%	2,900	1.28	120	12,700	1.94	790	15,700	1.81	910	10,000	1.50	490	92%
Akyem Open Pits	100%	1,000	0.70	20	700	0.67	20	1,700	0.69	40	1,800	1.18	70	92%
Akyem Underground	100%	—	—	—	8,300	3.92	1,050	8,300	3.92	1,050	5,300	3.27	560	92%
Total Akyem, Ghana		1,000	0.70	20	9,000	3.68	1,060	10,000	3.38	1,090	7,100	2.74	620	92%
NGM Open Pits and Stockpiles	38.5%	23,200	1.89	1,410	175,200	0.99	5,600	198,400	1.10	7,000	129,900	0.69	2,880	73%
NGM Underground	38.5%	9,800	6.48	2,040	16,600	5.84	3,110	26,400	6.08	5,150	19,500	6.63	4,150	86%
Total NGM, Nevada ¹⁰		33,000	3.25	3,450	191,700	1.41	8,700	224,800	1.68	12,160	149,300	1.47	7,040	79%
Total Gold		593,600	0.63	12,080	2,900,000	0.68	63,250	3,493,600	0.67	75,330	1,600,700	0.70	36,130	79%

Notes:

- Resources are reported exclusive of reserves. Amounts presented may not recalculate in total due to rounding.
- Resources, at sites in which Newmont is the operator, are estimated at a gold price of \$1,600 per ounce for 2022. Resources provided by other operators may use pricing that differs. Tonnage amounts have been rounded to the nearest 100,000. Ounces may not recalculate as they have been rounded to the nearest 10,000.
- Ounces are estimates of metal contained in ore tonnages and do not include allowances for processing losses. Metallurgical recovery rates represent the estimated amount of metal to be recovered through metallurgical extraction processes. Ounces may not recalculate as they are rounded to the nearest 10,000.
- Project is currently undeveloped. Resource estimates provided by Teck Resources, the Galore Creek joint venture partner.
- In 2022, Newmont increased its ownership interest in Yanacocha to 100% by acquiring Buenaventura's 43.65% noncontrolling interest and Sumitomo's 5% noncontrolling interest.
- Resource estimates provided by Barrick, the operator of Pueblo Viejo.
- Amounts presented herein have been rounded to the nearest 10,000 for ounces and 100,000 for tonnes and therefore may not agree to the respective Technical Report Summaries provided for certain properties as provided under exhibit 96 of the Newmont 2022 Annual Report for the year ended 31 December 2022.
- Project is currently undeveloped. Resource estimates provided by the NuevaUnión joint venture.
- Project is currently undeveloped. Resource estimates provided by the Norte Abierto joint venture.
- Resource estimates provided by Barrick, the operator of the NGM joint venture.

6. Profile of the Newmont Group

6.4 Resources and reserves *continued*

Table 6.4.8: Newmont's measured, indicated and inferred copper resources as at 31 December 2022

Copper resources at 31 December 2022^{1,2}

Deposits/ Districts	Newmont Share	Measured resources			Indicated resources			Measured and indicated resources			Inferred resources			Metallurgical Recovery ³
		Tonnage (000 tonnes)	Grade (Cu%)	Pounds (millions)	Tonnage (000 tonnes)	Grade (Cu%)	Pounds (millions)	Tonnage (000 tonnes)	Grade (Cu%)	Pounds (millions)	Tonnage (000 tonnes)	Grade (Cu%)	Pounds (millions)	
Galore Creek, Canada ⁴	50%	212,800	0.44%	2,060	385,600	0.47%	4,020	598,400	0.46%	6,080	118,900	0.26%	690	93%
Conga, Peru ⁵	100%	—	—	—	693,800	0.26%	3,970	693,800	0.26%	3,970	230,500	0.19%	950	84%
Yanacocha Open Pits	100%	—	—	—	94,600	0.39%	810	94,600	0.39%	810	36,400	0.39%	310	81%
Yanacocha Underground	100%	500	0.18%	—	6,200	0.12%	20	6,700	0.12%	20	3,400	0.13%	10	97%
Total Yanacocha, Peru ⁵		500	0.18%	—	100,800	0.37%	830	101,300	0.37%	830	39,700	0.37%	320	81%
NuevaUnión, Chile ⁶	50%	164,300	0.19%	700	349,900	0.34%	2,650	514,100	0.30%	3,360	602,200	0.39%	5,170	89%
Norte Abierto, Chile ⁷	50%	57,600	0.24%	310	551,300	0.19%	2,340	608,900	0.20%	2,640	361,800	0.18%	1,450	90%
Boddington, Western Australia	100%	92,800	0.11%	230	167,400	0.11%	420	260,200	0.11%	650	2,800	0.08%	10	82%
NGM, Nevada ⁸	38.5%	2,600	0.14%	10	116,900	0.14%	350	119,500	0.14%	360	19,900	0.13%	60	65%
Total Copper		530,600	0.28%	3,310	2,365,500	0.28%	14,580	2,896,100	0.28%	17,890	1,375,800	0.28%	8,640	88%

Notes:

- Resources are reported exclusive of reserves. Amounts presented may not recalculate in total due to rounding.
- Resources, at sites in which Newmont is the operator, are estimated at a copper price of \$4.00 per pound for 2022. Resources provided by other operators may use pricing that differs. Tonnage amounts have been rounded to the nearest 100,000.
- Pounds are estimates of metal contained in ore tonnages and do not include allowances for processing losses. Metallurgical recovery rates represent the estimated amount of metal to be recovered through metallurgical extraction processes. Pounds may not recalculate as they are rounded to the nearest 10 million.
- Project is currently undeveloped. Resource estimates provided by Teck Resources.
- In 2022, Newmont increased its ownership interest in Yanacocha to 100% by acquiring Buenaventura's 43.65% noncontrolling interest and Sumitomo's 5% noncontrolling interest. Refer to Note 1 of Newmont's consolidated financial statements for year ended 31 December 2022 for further information.
- Project is currently undeveloped. Resource estimates provided by the NuevaUnión joint venture.
- Project is currently undeveloped. Resource estimates provided by the Norte Abierto joint venture.
- Resource estimates provided by Barrick, the operator of the NGM joint venture.



6.4 Resources and reserves continued

Table 6.4.9: Newmont's measured, indicated and inferred silver resources as at 31 December 2022

Silver resources at 31 December 2022^{1,2}

Deposits/ Districts	Newmont Share	Measured resources			Indicated resources			Measured and indicated resources			Inferred resources			Metallurgical Recovery ³
		Tonnage (000 tonnes)	Grade (g/tonne)	Ounces (000)	Tonnage (000 tonnes)	Grade (g/tonne)	Ounces (000)	Tonnage (000 tonnes)	Grade (g/tonne)	Ounces (000)	Tonnage (000 tonnes)	Grade (g/tonne)	Ounces (000)	
Peñasquito, Mexico	100%	47,400	23.94	36,510	263,500	23.99	203,240	311,000	23.98	239,740	84,700	27.24	74,220	86%
Noche Buena, Mexico	50%	—	—	—	19,900	13.99	8,970	19,900	13.99	8,970	1,600	10.98	550	25%
Galore Creek, Canada ⁴	50%	212,800	4.08	27,950	385,600	4.77	59,100	598,400	4.52	87,040	118,900	2.60	9,940	73%
Conga, Peru ⁵	100%	—	—	—	693,800	2.06	45,910	693,800	2.06	45,910	175,000	1.13	6,330	70%
Yanacocha Open Pits	100%	12,500	3.30	1,330	108,100	11.11	38,610	120,600	10.30	39,930	29,600	12.52	11,920	41%
Yanacocha Underground	100%	500	0.37	10	6,200	37.02	7,350	6,700	34.23	7,350	3,400	40.45	4,390	83%
Total Yanacocha, Peru ⁵		13,000	3.19	1,330	114,200	12.51	45,950	127,200	11.56	47,290	33,000	15.38	16,310	49%
Cerro Negro Underground	100%	200	42.43	210	1,500	51.31	2,490	1,700	50.51	2,690	5,700	35.10	6,450	76%
Cerro Negro Open Pit	100%	1,200	6.77	260	1,200	6.63	250	2,400	6.70	520	300	6.68	70	60%
Total Cerro Negro Argentina		1,400	10.72	470	2,700	31.64	2,740	4,100	24.64	3,210	6,000	33.66	6,520	75%
Pueblo Viejo, Dominican Republic ^{6,7}	40%	7,300	7.68	1,810	33,200	8.28	8,840	40,600	8.17	10,650	3,000	10.49	1,030	74%
NuevaUnión, Chile ⁸	50%	164,300	0.96	5,080	349,900	1.19	13,370	514,100	1.12	18,440	602,200	1.16	22,530	66%
Norte Abierto, Chile ⁹	50%	77,200	1.20	2,990	596,900	1.07	20,550	674,200	1.09	23,540	369,600	0.95	11,340	78%
NGM, Nevada ¹⁰	38.5%	2,400	5.33	410	81,700	5.46	14,340	84,100	5.46	14,760	18,700	5.57	3,350	38%
Total Silver		525,900	4.53	76,550	2,541,500	5.18	423,010	3,067,400	5.07	499,560	1,412,800	3.35	152,120	75%

Notes:

- Resources are reported exclusive of reserves. Amounts presented may not recalculate in total due to rounding.
- Resources, at sites in which Newmont is the operator, are estimated at a silver price of \$23 per ounce for 2022. Resources provided by other operators may use pricing that differs. Tonnage amounts have been rounded to the nearest 100,000.
- Ounces are estimates of metal contained in ore tonnages and do not include allowances for processing losses. Metallurgical recovery rates represent the estimated amount of metal to be recovered through metallurgical extraction processes. Ounces may not recalculate as they are rounded to the nearest 10,000.
- Project is currently undeveloped. Resource estimates provided by Teck Resources.
- In 2022, Newmont increased its ownership interest in Yanacocha to 100% by acquiring Buenaventura's 43.65% noncontrolling interest and Sumitomo's 5% noncontrolling interest. Refer to Note 1 to Newmont's consolidated financial statements for the year ended 31 December 2022 for further information.
- Resource estimates provided by Barrick, the operator of the Pueblo Viejo.
- Amounts presented herein have been rounded to the nearest 10,000 for ounces and 100,000 for tonnes and therefore may not agree to the respective Technical Report Summaries provided for certain properties as provided under exhibit 96 in the Newmont 2022 Annual Report for the year ended 31 December 2022.
- Project is currently undeveloped. Resource estimates provided by the NuevaUnión joint venture.
- Project is currently undeveloped. Resource estimates provided by the Norte Abierto joint venture.
- Resource estimates provided by Barrick, the operator of the NGM joint venture.

6. Profile of the Newmont Group

6.4 Resources and reserves *continued*

Table 6.4.10: Newmont's measured, indicated and inferred lead resources as at 31 December 2022

Lead resources at 31 December 2022^{1,2}

Deposits/ Districts	Newmont Share	Measured resource			Indicated resource			Measured and indicated resource			Inferred resource			Metallurgical Recovery ³
		Tonnage (000 tonnes)	Grade (Pb%)	Pounds (millions)	Tonnage (000 tonnes)	Grade (Pb%)	Pounds (millions)	Tonnage (000 tonnes)	Grade (Pb%)	Pounds (millions)	Tonnage (000 tonnes)	Grade (Pb%)	Pounds (millions)	
Peñasquito, Mexico	100%	47,400	0.26%	270	263,500	0.23%	1,360	311,000	0.24%	1,630	84,700	0.23%	440	72%
Total Lead		47,400	0.26%	270	263,500	0.23%	1,360	311,000	0.24%	1,630	84,700	0.23%	440	72%

Notes:

- Resources are reported exclusive of reserves.
- Resources are estimated at a lead price of \$1.20 per pound for 2022. Tonnage amounts have been rounded to the nearest 100,000.
- Pounds are estimates of metal contained in ore tonnages and do not include allowances for processing losses. Metallurgical recovery rates represent the estimated amount of metal to be recovered through metallurgical extraction processes. Pounds may not recalculate as they are rounded to the nearest 10 million.

Table 6.4.11: Newmont's measured, indicated and inferred zinc resources as at 31 December 2022

Zinc resources at 31 December 2022^{1,2}

Deposits/ Districts	Newmont Share	Measured resource			Indicated resource			Measured and indicated resource			Inferred resource			Metallurgical Recovery ³
		Tonnage (000 tonnes)	Grade (Zn%)	Pounds (millions)	Tonnage (000 tonnes)	Grade (Zn%)	Pounds (millions)	Tonnage (000 tonnes)	Grade (Zn%)	Pounds (millions)	Tonnage (000 tonnes)	Grade (Zn%)	Pounds (millions)	
Peñasquito, Mexico	100%	47,400	0.62%	650	263,500	0.53%	3,080	311,000	0.54%	3,740	84,700	0.53%	1,000	81%
Total Zinc		47,400	0.62%	650	263,500	0.53%	3,080	311,000	0.54%	3,740	84,700	0.53%	1,000	81%

Notes:

- Resources are reported exclusive of reserves.
- Resources are estimated at a zinc price of \$1.45 per pound for 2022. Tonnage amounts have been rounded to the nearest 100,000.
- Pounds are estimates of metal contained in ore tonnages and do not include allowances for processing losses. Metallurgical recovery rates represent the estimated amount of metal to be recovered through metallurgical extraction processes. Pounds may not recalculate as they are rounded to the nearest 10 million.

Table 6.4.12: Newmont's measured, indicated and inferred molybdenum resources as at 31 December 2022

Molybdenum resources at 31 December 2022^{1,2}

Deposits/ Districts	Newmont Share	Measured resource			Indicated resource			Measured and indicated resource			Inferred resource			Metallurgical Recovery ³
		Tonnage (000 tonnes)	Grade (Mo%)	Pounds (millions)	Tonnage (000 tonnes)	Grade (Mo%)	Pounds (millions)	Tonnage (000 tonnes)	Grade (Mo%)	Pounds (millions)	Tonnage (000 tonnes)	Grade (Mo%)	Pounds (millions)	
NuevaUnión, Chile ⁴	50%	159,500	0.01%	20	231,500	0.01%	40	391,000	0.01%	70	362,300	0.01%	100	52%
Total Molybdenum		159,500	0.01%	20	231,500	0.01%	40	391,000	0.01%	70	362,300	0.01%	100	52%

Notes:

- Resources are reported exclusive of reserves.
- Resources for NuevaUnión are estimated based on a molybdenum price set by NuevaUnión joint venture. Tonnage amounts have been rounded to the nearest 100,000.
- Pounds are estimates of metal contained in ore tonnages and do not include allowances for processing losses. Metallurgical recovery rates represent the estimated amount of metal to be recovered through metallurgical extraction processes. Pounds may not recalculate as they are rounded to the nearest 10 million.
- Project is currently undeveloped. Resource estimates provided by NuevaUnión joint venture.

See the cautionary statement in section 6.2.



6.4 Resources and reserves *continued*

c) ASX Listing Rule 5.12 disclosures

ASX explanation	Newmont commentary
<p>The source and date of the historical estimates or foreign estimates.</p> <p><i>ASX Listing Rule 5.12.1</i></p>	<p>The foreign estimates in respect of Newmont's operations and properties were prepared by Newmont. The mineral resources and mineral reserves are prepared in accordance with Subpart 1300. The source of Newmont's foreign estimates is the Newmont FY22 Annual Report, which has been publicly disclosed and filed with the SEC. A copy of the Newmont FY22 Annual Report is available on the Newmont website at www.newmont.com. The foreign estimates are effective as at 31 December 2022 and, so far as Newmont is concerned, are the most recent available mineral resources and mineral reserves estimates for Newmont's operations and projects.</p>
<p>Whether the historical estimates or foreign estimates use categories of mineralisation other than those defined in Appendix 5A (JORC Code) and if so, an explanation of the differences.</p> <p><i>ASX Listing Rule 5.12.2</i></p>	<p>The Newmont foreign estimates of mineral resources and mineral reserves have been prepared using the categories of mineralisation set forth in Subpart 1300. Newmont considers the foreign estimates to be consistent with the requirements of Subpart 1300.</p> <p>The reporting requirements prescribed by Subpart 1300 and with which Newmont's reporting complies, and the Australian and Canadian Standards have similar goals in terms of conveying an appropriate level of confidence in the disclosures being reported, but embody different approaches and definitions and differ in several respects. For example, the terms "Ore Reserve", "Proved Ore Reserve", "Probable Ore Reserve", "Mineral Resource", "Measured Mineral Resource", "Indicated Mineral Resource" and "Inferred Mineral Resource" are Australian mining terms as defined in the JORC Code, and their definitions differ from the definitions of the terms "mineral reserve", "proven mineral reserve", "probable mineral reserve", "mineral resource", "measured mineral resource", "indicated mineral resource" and "inferred mineral resource" as included in the Subpart 1300. Additionally, the JORC Code allows (i) Measured and Indicated Mineral Resources to be reported inclusive of Mineral Resources modified to produce its Ore Reserves and (ii) the inclusion of Inferred Mineral Resources in an estimate of Ore Reserves, on the condition that such Inferred Resources are treated as waste material for the purpose of financial evaluation. By contrast, Subpart 1300 requires mineral resources to be reported exclusive of mineral reserves and does not allow the inclusion of inferred mineral resources or unclassified material in an estimate of mineral reserves.</p>
<p>The relevance and materiality of the historical estimates or foreign estimates to the entity.</p> <p><i>ASX Listing Rule 5.12.3</i></p>	<p>The Newmont foreign estimates are material to the Merged Group as they form a significant portion of the overall mineral reserve and mineral resource inventory.</p>
<p>The reliability of historical estimates or foreign estimates to the entity.</p> <p><i>ASX Listing Rule 5.12.4</i></p>	<p>The foreign estimates are considered reliable by Newmont for the following reasons:</p> <ul style="list-style-type: none"> – the foreign estimates have been reported in the Newmont FY22 Annual Report by an individual who is considered to be a Qualified Person as defined in Subpart 1300. Newmont has robust and longstanding processes and procedures that support this individual taking responsibility for the declared reserves and resources; and – the methodologies for preparing the mineral resources and mineral reserves have not changed significantly in comparison to previous reporting.
<p>To the extent known, a summary of work programs on which the historical estimates or foreign estimates are based and a summary of the key assumptions, mining and processing parameters and methods used to prepare the historical or foreign estimates.</p> <p><i>ASX Listing Rule 5.12.5</i></p>	<p>Key geological, mining and metallurgical assumptions used in the estimation of mineral resources and mineral reserves are based on extensive operating experience and historical performance for the operating sites and at least pre-feasibility studies (as defined in Subpart 1300) for the projects. A summary of the key assumptions, including gold price and cut-off grades, are set forth in the notes to the tables included in the Proven and Probable Reserves and Measured, Indicated and Inferred Resources sections in the Newmont FY22 Annual Report. More detailed information has been provided for Newmont's material sites in Technical Report Summary documents that have been filed with the SEC and are publicly available.</p>
<p>Any more recent estimates or data relevant to the reported mineralisation available to the entity.</p> <p><i>ASX Listing Rule 5.12.6</i></p>	<p>No more recent estimates have been completed on Newmont's operations and projects since the mineral reserves and mineral resources disclosed in the Newmont FY22 Annual Report.</p>

6. Profile of the Newmont Group

6.4 Resources and reserves *continued*

ASX explanation

The evaluation and/or exploration work that needs to be completed to verify the historical estimates or foreign estimates as mineral resources or ore reserves in accordance with ASX Listing Rules Appendix 5A (JORC Code).

ASX Listing Rule 5.12.7

The proposed timing of any evaluation and/or exploration work that the entity intends to undertake and a comment on how the entity intends to fund that work.

ASX Listing Rule 5.12.8

A cautionary statement proximate to, and with equal prominence as, the reported historical estimates or foreign estimates stating that:

- The estimates are historical estimates or foreign estimates and are not reported in accordance with the JORC Code;
- A competent person has not done sufficient work to classify the historical estimates or foreign estimates as mineral resources or ore reserves in accordance with the JORC Code; and
- It is uncertain that following evaluation and/or further exploration work that the historical estimates or foreign estimates will be able to be reported as mineral resource or ore reserves in accordance with the JORC Code.

ASX Listing Rule 5.12.9

A statement by a named competent person or persons that the information in the market announcement provided under rules 5.12.2 to 5.12.7 is an accurate representation of the available data and studies for the material mining project. The statement must include the information referred to in rule 5.22(b) and (c).

ASX Listing Rule 5.12.10

Newmont commentary

Newmont intends for all future mineral reserves and mineral resources estimates released for Newmont and Newcrest operations and projects to be prepared in accordance with Subpart 1300.

Ongoing evaluation work is planned to be completed during 2023 and will be reported in Newmont's mineral reserves and mineral resources update included in the Newmont Annual Report for the year ended 31 December 2023. There is no intention to verify Newmont's reserves and resources estimates for Newmont in accordance with the JORC Code.

Newmont cautions that mineral resources and mineral reserves for the Newmont operations and projects are not reported in accordance with the JORC Code.

A competent person has not yet completed sufficient work to classify the foreign estimates of mineral resources or mineral reserves as Mineral Resources or Ore Reserves in accordance with the JORC Code.

It is currently uncertain whether, following evaluation and/or further exploration work, these foreign estimates will be able to be reported as Mineral Resources or Ore Reserves in accordance with the JORC Code.

Refer to section 11.13(b).

6.5 Environment, social and governance

Environmental, social and governance (**ESG**) is a key part of how Newmont makes investment decisions and central to its culture and purpose to create value and improve lives through sustainable and responsible mining. Safety and Sustainability is integrated into Newmont's business through global policies, standards, strategies, business plans and remuneration plans.

a) Health and safety

Safety is one of Newmont's core values and the health, safety, wellbeing and security of its employees and communities is Newmont's first priority. As set out in Newmont's global Health, Safety and Security Policy, Newmont aims to achieve this priority by focusing on people, consistently applying leading practices and systems across its business and taking a balanced approach to health, safety, wellbeing and security to ensure a focus on actual and potential severity.

Newmont's health, safety, wellbeing and security standards, guidelines, operating procedures and systems detail the accountabilities, mandatory controls and minimum requirements for managing work-related and community safety and health risks. Newmont also partners with its contractors to ensure its health, safety, wellbeing and security requirements and objectives are met.

Newmont's Health, Safety and Security Strategy is reviewed by the Newmont Board's Safety and Sustainability Committee and its Health & Safety Management System is audited regularly by Newmont as part of Newmont's assurance and governance processes.

Detailed reports on health, safety and security performance are provided to both Newmont's Board and its Safety and Sustainability Committee on a quarterly basis. The Newmont Board also reviews all significant health and safety matters, including fatalities, significant potential events and pandemics.

Newmont's health and safety statistics between 2018 – 2022

	2018	2019	2020	2021	2022
Fatalities	1	0	0	0	0
Lost Time Injury Frequency Rate (LTIFR)	0.24	0.27	0.18	0.22	0.22
Total Recordable Injury Frequency Rate (TRIFR)	0.36	0.41	0.30	0.41	0.41
Occupational Illness Frequency Rate (OIFR)	0.08	0.07	0.05	0.06	0.01



6.5 Environment, social and governance *continued*

b) Sustainability

Sustainability is one of Newmont's core values, and Newmont is committed to serving as a catalyst for positive change and sustainable development through leading ESG practices. Newmont's refreshed Sustainability and External Relations, People, and Health, Safety and Security Strategies address the growing expectations of investors, governments, communities and other key stakeholders and aim to drive performance through clear targets, open communications and transparent reporting.

1) Governance

Strong corporate governance, which requires constructive relationships among stakeholders and a clear structure of policies, standards, processes and responsibilities, helps control risk, supports ethical conduct and effectively guides the direction and operation of Newmont. At Newmont, management accountability and active oversight of an experienced, diverse board of directors are integral to having a culture of integrity, meeting stakeholder expectations and fulfilling Newmont's sustainability commitments.

The Newmont Board is responsible for providing oversight and holding management accountable for Newmont's safety and sustainability performance. The Newmont Board delegates specific matters to each of the Newmont Board's committees.

The Safety and Sustainability Committee provides advice and oversight on Newmont's efforts to adopt practices in the promotion of a healthy and safe work environment, and environmentally sound and socially responsible mining and resource development.

Primary responsibility for the daily implementation and management of sustainability matters rests with Newmont management. All Newmont executives are actively engaged in sustainability matters and the associated risks. Although Newmont's President and CEO has overall responsibility for alignment of sustainability with Newmont's corporate strategy, Newmont has sustainability-focused leaders on its executive leadership and senior leadership teams.

Newmont's governance structure for Sustainability



Further details are available in Newmont's 2022 Sustainability Report, available via the Newmont website.

2) Environmental areas of focus

There are a number of areas that Newmont includes in its management of performance and risk for environmental management including water, tailings, energy and climate change, biodiversity, materials, and closure and reclamation.

- **Water:** Access to clean, safe water is a human right. Mining activities require water and can potentially impact local water supplies. Newmont's Global Water Strategy guides its efforts to understand shared challenges, reduce water-related risks and improve its water management performance. Newmont is transitioning to an approach that integrates nature, identifying co-benefits and improving the health, wellbeing and resiliency of ecosystems and other shared natural resources.

6. Profile of the Newmont Group

6.5 Environment, social and governance continued

2) Environmental areas of focus continued

- **Tailings:** Mining and mineral processing activities produce tailings, which are a waste product that, if not managed properly, can threaten human health and the environment. Newmont aims to manage all wastes, including tailings, by implementing best practices. Newmont is committed to conforming with Global Industry Standard on Tailings Management (**GISTM**) and achieving the goal of zero harm to people and the environment.
- **Energy & climate change:** Climate change remains an existential threat to the world. Newmont's stakeholders, including investors, expect action to transition toward a more resilient low-carbon economy and to do so in a way that minimises risks and maximises social and economic opportunities. Newmont's global Energy and Climate Strategy uses science-based targets to reduce greenhouse gas (**GHG**) emissions and takes an integrated approach, working alongside governments and communities, to accelerate an equitable transition to a low-carbon economy.

Specifically, in 2020 Newmont set public climate targets to reduce GHG emissions by 32% for Scope 1 and 2 (compared to 2018 baseline) and by 30 percent for Scope 3 (compared to 2019 baseline) by 2030 and ultimately be carbon neutral by 2050. Newmont's 2030 emissions reduction targets align with the Science Based Targets initiative's (**SBTi's**) science-based criteria, which ensures objectives support the Paris Agreement's goal of limiting global warming to well below 2°C compared to pre-industrial levels. In 2021, Newmont received approval for such targets from SBTi. Changes to the calculation methodology in 2022 required Newmont to rebase Scope 3 emissions, and Newmont resubmitted Scope 3 targets to SBTi, which approved them in 2022. Newmont's targets are set forth below.

2030 Climate targets

Target	Base year	2030
32% reduction of Scope 1 and 2 emissions ¹ (million tones of carbon dioxide equivalent)	3.57	2.40
32% reduction of Scope 1 and 2 emissions intensity ¹ (thousand tones of carbon dioxide equivalent)	0.61	0.41
30% reduction of Scope 3 emissions ² (million tones of carbon dioxide equivalent)	5.72	4.00

Notes:

1. 2018 base year.
2. 2019 base year.

To achieve 2030 emissions reduction targets, Newmont has developed a pathway with planned short and medium-term decarbonisation projects. For example, Newmont's targeted investment areas in connection with Scope 1 and 2 emissions reduction activities, which include (i) development of renewable power sources at Boddington, Tanami, Merian and Peñasquito; (ii) implementation of energy management and efficiencies in equipment, process optimisation, energy recovery and other areas at prioritised sites; (iii) transition of diesel to electric vehicles for mining production, referred to as Newmont's Vision Zero (**VO**) strategic alliance with Caterpillar; and (iv) other initiatives that support improved visibility of energy consumption and support efforts to reduce emissions across Newmont's portfolio.

- **Biodiversity:** Biodiversity spans four areas of nature: land, fresh water, ocean and atmosphere, and it is critical for sustaining and stabilising ecosystems to remedy the global challenge of environmental degradation and habitat loss. Newmont recognises that local communities and its operations rely on healthy and functioning ecosystems to thrive. Newmont's commitment to No Net Loss of Key Biodiversity Values (**KBVs**) due to mine-related activities is integrated into its approach and essential to achieving positive nature outcomes.

In conformance with Newmont's global Risk Management System, all operating sites and projects must conduct biodiversity and ecosystem impact assessments to identify risks and impacts. If a Newmont site identifies KBVs it must develop a biodiversity action plan to achieve site-specific objectives that will (i) seek to avoid and/or minimise impacts to KBVs; (ii) engage with stakeholders and partner on solutions; and (iii) integrate long-term goals and measurable targets. Where avoidance and/or minimisation are not possible, then rehabilitation and/or restoration actions are taken to achieve conservation outcomes. If No Net Loss of KBVs cannot be achieved through these measures, then a biodiversity offset is required. Many of Newmont's operations have KBVs within the relevant area of influence and a biodiversity action plan to mitigate potential impacts. Currently, four Newmont sites, Akyem, Boddington, Yanacocha and Merian, require offsets to achieve No Net Loss to KBVs.

- **Materials:** Monitoring materials and waste that can possibly harm people and the environment is essential to every business. Throughout the life of a mine, many activities require materials and generate waste, including items such as chemicals, mercury and waste rock, that may pose a risk if not managed properly. Newmont has robust management systems and controls in place to mitigate and prevent potential negative impacts on people and the environment while reducing long-term liabilities throughout the mine lifecycle.
- **Closure and Reclamation:** All mines have a finite operating life, making responsible closure planning essential to address the complex social, economic, environmental and regulatory impacts related to the end of mining operations. Newmont's global Closure Strategy integrates closure planning across the business and throughout the life of each operation. Newmont seeks to leave long-term positive and sustainable legacies long after mining ceases.



6.5 Environment, social and governance *continued*

3) Reporting and performance

Newmont believes that engagement and transparency are essential to building trust and credibility with stakeholders. Newmont's leadership, through participation, engagement and reporting, seeks to reduce risks and build accountability and trust.

Reporting is completed annually by Newmont with the Sustainability Report and Climate Report, as well as other supporting external disclosures (e.g. Carbon Disclosure Project and Corporate Sustainability Assessment). Performance data reflects the annual disclosure of Newmont's sustainability performance at wholly owned operations and joint ventures where Newmont is the operator. Any variances from these boundaries are noted. The methodology and basis of data preparation related to the selected performance metrics for 2022 Sustainability Report and Climate Report is available via the Newmont website.

Newmont uses metrics, indices and public targets to assess performance in managing sustainability risks and opportunities.

Further details, including as to Newmont's progress against its targets, are available in Newmont's 2022 Sustainability Report, accessible via www.newmont.com/sustainability/sustainability-reporting/, and its 2022 Climate Report, accessible via www.newmont.com/sustainability/Climate-Change/.

6.6 Strategy

As the world's leading gold company, Newmont's strategy is to create value for all Newmont Stockholders and stakeholders through efforts to:

- Deliver superior operational execution by ensuring fatality risks are managed at all times with strong leadership and systems, continually improving operational performance, and meeting commitments without fail.
- Sustain a global portfolio of long-life assets by growing margins, reserves and resources from profitable expansions, exploration and value accretive investments.
- Lead the gold sector in profitability and responsibility by consistently generating superior returns, demonstrating Newmont's values, and leading in environmental, social and governance performance.

To support this strategy, Newmont is focussed on five foundational principles.

- **Health and Safety:** Maintaining a fatality, injury and illness free performance and culture by ensuring visible and caring leadership, fatality prevention and physical and mental wellbeing.
- **Operational Excellence:** Growing margins and delivering a culture of continuous improvement through full potential and a rigorous application of operating, technical and exploration discipline.
- **Growth:** Optimising Newmont's project pipeline of world-class assets in top-tier jurisdictions to support value accretive growth and a focus on industry-leading return on capital employed.
- **People:** Developing competitive advantage through people with industry leading engagement, leadership and commitment to inclusion and diversity.
- **Environmental, Social and Governance:** Seeking to achieve long-term competitive advantage through leading sustainability practices to enable business continuity and growth, support positive social transformation and create shared, long-term value for all stakeholders.

6.7 Dividend framework and history

In 2020, Newmont introduced a non-binding dividend framework.⁴⁹ The dividend payout ranges within the dividend framework are periodically assessed by the Newmont Board, including every year through annual business planning process, and for 2023, are based on the price of gold and evaluated in increments of \$300 per ounce. Newmont's non-binding dividend framework for 2023 provides Newmont Stockholders with a stable base dividend of \$1.00/share calibrated at Newmont's gold reserve price assumption and a variable component based on incremental free cash flow above that base assumption.

49. Newmont's future dividends have not yet been approved or declared by the Newmont Board. The dividend framework is non-binding and an annualised dividend payout level has not been declared by the Board. Newmont's dividend framework and expected 2023 dividend payout ranges are non-binding and do not represent a legal commitment. Future dividends beyond the dividend payable on 21 September 2023 to holders of record at the close of business on 7 September 2023 have not yet been approved or declared by the Newmont board of directors. Newmont management's expectations with respect to future dividends, annualised dividends, payout ranges or dividend yield are "forward-looking statements". The declaration and payment of future dividends remain at the discretion of the Newmont Board and will be determined based on Newmont's financial results, balance sheet strength, cash and liquidity requirements, future prospects, gold and commodity prices, and other factors deemed relevant by the Board. The duration, scope and impact of COVID-19 presents additional uncertainties with respect to future dividends and no assurance is being provided that Newmont will pay future dividends at the increased payment level. The Newmont Board periodically reviews and assesses this non-binding dividend framework and reserves all powers related to the declaration and payment of dividends. Consequently, in determining the dividends to be declared and paid on Newmont Shares, the Newmont Board may revise or terminate the payment level at any time without prior notice.

6. Profile of the Newmont Group

6.8 Newmont Board

a) Board profiles

As at the date of this Scheme Booklet, the Newmont Board comprises the following directors:

Name and position	Profile
Gregory H. Boyce Independent Chair of the Board; Chair of the Corporate Governance and Nominating Committee	<p>Gregory H. Boyce has served as Independent Chair of the Newmont Board since 2021 and as director since 2015. Prior to joining Newmont, Mr. Boyce served as Executive Chairman of Peabody Energy from 2007 to 2015. He joined Peabody in 2003 as Chief Operating Officer, and assumed responsibility for Peabody as Chief Executive Officer from 2006-2015. His previous leadership roles also include Chief Executive Officer, Energy for Rio Tinto; President and Chief Executive Officer of Kennecott Energy Company; and President of Kennecott Minerals Company. Mr. Boyce is a past Chair of the Coal Industry Advisory Board of the International Energy Agency and is a former Chair of the National Mining Association. He previously served on the Board of Directors of the US- China Business Council, and was a member of The Business Council, Business Roundtable and the National Coal Council. Mr. Boyce holds a Bachelor of Science degree in mining engineering from the University of Arizona and an Advanced Management Program degree from Harvard University's Graduate School of Business.</p> <p>Mr. Boyce has extensive knowledge and experience in operations and global mining, including public company chair and chief executive officer experience.</p>
Thomas R. Palmer President; Chief Executive Officer and Director	<p>Thomas R. Palmer has served as President and Chief Executive Officer and director of the Newmont Board since October 2019. He served as President since June 2019 and as President and Chief Operating Officer from November 2018 until June 2019. Previously, he served as Executive Vice President and Chief Operating Officer since May 2016. Mr. Palmer was elected Senior Vice President, Asia Pacific in February 2015 after serving as Senior Vice President, Indonesia since March 2014. Prior to joining Newmont, he served as Chief Operating Officer, Pilbara Mines at Rio Tinto Iron Ore. Over a 20-year career with Rio Tinto, Mr. Palmer worked in a variety of roles across a number of commodities, including General Manager, Technology for the Bauxite and Alumina business; General Manager, Operations at Hail Creek coal mine; and General Manager, Asset Management at Palabora Mining Company in South Africa. Mr. Palmer holds a Master of Engineering Science degree and a Bachelor of Engineering degree from Monash University in Melbourne, Australia.</p> <p>Mr. Palmer has extensive experience leading teams and delivering production while implementing safety culture programs and improving diversity. Mr Palmer also has proven experience with delivery of synergies and business integration.</p>
Patrick G. Awuah, Jr. Independent Director	<p>Patrick G. Awuah, Jr. is the Founder and President of Ashesi University, a private, not-for-profit institution that has quickly gained a reputation for innovation and quality education in Ghana. Before founding Ashesi University, Mr. Awuah worked as a Program Manager for Microsoft where, among other things, he spearheaded the development of dial-up internet working technologies and gained a reputation for bringing difficult projects to completion. Mr. Awuah is also a Fellow of the Africa Leadership Initiative (a branch of the Aspen Global Leadership Network), and a member of the United States Council on Foreign Relations and the Pacific Council on International Policy. He served on the Advisory Committee on Voluntary Foreign Aid (ACVFA) of the US Agency for International Development from 2010 to 2016. He was awarded the distinction of the Membership of the Order of the Volta, one of Ghana's highest awards, given to individuals who exemplify the ideal of service to the country. In 2015, Mr. Awuah was listed by Fortune Magazine as number 40 in world's 50 greatest leaders and was awarded a MacArthur Fellowship. Mr. Awuah holds a Bachelor of Science in Engineering and Bachelor of Arts in Economics from Swarthmore College, a Master of Business Administration from the University of California, Berkeley and four honorary doctorates.</p> <p>Mr. Awuah has extensive international experience as a global leader in world economics.</p>
Bruce R. Brook Independent Director; Chair of the Audit Committee	<p>Bruce R. Brook retired from WMC Resources Limited in 2005 where he was Chief Financial Officer. Mr. Brook also held key executive roles including Deputy Chief Finance Officer of ANZ Banking Group Limited, Group Chief Accountant of Pacific Dunlop Limited and General Manager, Group Accounting positions at CRA Limited and Pasminco Limited. Mr. Brook has extensive board, Audit Committee and executive leadership experience in diverse industries, including mining, finance, manufacturing and chemicals. Mr. Brook holds a Bachelor of Commerce and Accounting from University of the Witwatersrand.</p> <p>Mr. Brook is an expert in accounting and financial reporting, including internal control over financial reporting.</p>
Maura J. Clark Independent Director	<p>Maura J. Clark retired from Direct Energy, a subsidiary of Centrica plc, in March 2014 where she was President of Direct Energy Business, a leading energy retailer in Canada and the United States. Previously, Ms. Clark was Executive Vice President of North American Strategy and Mergers and Acquisitions for Direct Energy. Ms. Clark's prior experience includes investment banking and serving as Chief Financial Officer of an independent oil refining and marketing company. Ms. Clark has extensive board, Audit Committee, strategic finance and executive leadership experience. She is a member of the Association of Chartered Professional Accountants of Ontario. Ms. Clark holds a Bachelor of Arts in Economics from Queen's University.</p> <p>Ms. Clark has extensive experience as a leader in the energy industry including managing matters related to regulatory, policy and social responsibility.</p>



6.8 Newmont Board *continued*

Name and position	Profile
Emma FitzGerald Independent Director	<p>Dr. Emma FitzGerald currently serves on the Boards of Seplat Energy plc, UPM Kymmene Oyj and Graphene Manufacturing Group. Dr. FitzGerald stepped down as Chief Executive and Executive Director of Puma Energy International, a global energy business, focused on delivering energy solutions in Central America, Africa and Asia, in 2021. Prior to joining Puma Energy, Dr. FitzGerald served as Executive Director of Severn Trent plc, a United Kingdom water & waste services business, from 2015 to 2018. From 2013 to 2015 she served as Chief Executive Officer of gas distribution at National Grid plc, a United Kingdom utility, and prior to that she spent over 20 years with Royal Dutch Shell in various senior leadership roles in their Downstream business. Dr. FitzGerald holds a Master of Business Administration from Manchester Business School and a Doctor of Philosophy in Surface Chemistry from Balliol College, Oxford University.</p> <p>Dr. FitzGerald has extensive international business experience and has served on plc, privately owned and not for profit Boards in both an Executive and Non Executive Director capacity for 12 years.</p>
Mary A. Laschinger Independent Director	<p>Mary A. Laschinger retired from Veritiv Corporation in 2020 as Chair of the board and Chief Executive Officer. Previously, Ms. Laschinger served as Senior Vice President of International Paper Company from 2007 to July 2014, and as President of xpedx, International Paper's distribution business, from January 2010 to July 2014. She also served as President of the Europe, Middle East, Africa and Russia business at International Paper from 2005 until 2010, Vice President and General Manager of International Paper's Wood Products and Pulp businesses, as well as in other senior management roles in sales, marketing, manufacturing and supply chain throughout the organisation. Ms. Laschinger holds a Bachelor of Arts degree in business from the University of Wisconsin and a Master of Business Administration from the University of Connecticut. She also completed postgraduate studies in executive management at the Kellogg School of Management at Northwestern University.</p> <p>Ms. Laschinger has extensive knowledge and experience in operations, including public company chief executive officer experience.</p>
José Manuel Madero Independent Director	<p>José Manuel Madero is the Founder and Managing Partner of Bizwp SC, a consulting firm with a strong focus on advising companies in increasing Social/Financial Profitability based out of Mexico City. Mr Madero currently serves on the Board of Constellation Brands, Inc. since 2019, and in July 2023 was appointed Interim Chairman of the Board. From 2015 to 2019, Mr. Madero served as Chief Executive Officer at Grupo Bepensa, a Mexican business conglomerate comprised of 40 companies across the industrial, automotive, financial services, and non-alcoholic and alcoholic beverage sectors and from 2005 to 2015, Mr. Madero held various senior management positions at Monsanto Company. Mr. Madero holds a Bachelor of Science in Mine Engineering from the Colorado School of Mines and a Master of Business Administration in Entrepreneurship and International Business Finance from FW Ollin Graduate School of Business at Babson College.</p> <p>Mr. Madero has expertise in executive leadership, international business matters, operations, finance, and strategic planning.</p>
René Médori Independent Director	<p>René Médori retired from Anglo American plc in 2018 where he was Finance Director since 2005. Until 2017, Mr. Médori was a non-executive director of De Beers and Anglo American Platinum Limited. He was a non-executive director of SSE plc until December 2017 and Cobham plc until January 2020. Mr. Médori holds a doctorate in economics and degrees in finance and economics from the Université de Paris-Dauphine, France, and completed the Financial Management Programme at the Graduate School of Business, Stanford University.</p> <p>Mr. Médori has significant financial and commercial expertise from capital intensive businesses, supplying products to the oil refining, steel and mining industries and experience in international finance in the United Kingdom, Europe and the United States.</p>
Jane Nelson Independent Director; Chair of the Safety and Sustainability Committee	<p>Jane Nelson is Founding Director of the Corporate Responsibility Initiative at Harvard Kennedy School, and a non-resident senior fellow at the Global Economy and Development Program at the Brookings Institution.</p> <p>Ms. Nelson is a current Commissioner of the Business Commission to Tackle Inequality, hosted by the World Business Council for Sustainable Development. Ms. Nelson is a member of the World Economic Forums Global Future Council (GFC) on Good Governance and was previously a member of the GFC on Transparency and Anti-Corruption. She has also served on the South32 Board of Directors since May 2023. From 1993 to 2009, Ms. Nelson was a Director at the International Business Leaders Forum, and a senior advisor until 2013. She has also been a senior associate of the Programme for Sustainability Leadership at Cambridge University. Ms. Nelson holds a Master of Arts and Bachelor of Arts in Philosophy, Politics and Economics from the University of Oxford and a Bachelor of Science in Agriculture with a major in Economics (cum laude) from the University of Natal (now University of Kwazulu-Natal), South Africa, and a former Rhodes Scholar.</p> <p>Ms. Nelson has significant experience in corporate responsibility, public-private partnerships, and global economics.</p>

6. Profile of the Newmont Group

6.8 Newmont Board *continued*

Name and position	Profile
Julio M. Quintana Independent Director; Chair of the Leadership Development and Compensation Committee	<p>Julio M. Quintana currently serves on the Board of SM Energy Company since 2006 and in May 2023 was appointed Chairman of the Board. Mr. Quintana currently also serves on the Board of California Resources Corporation since 2020. Mr. Quintana retired from Tesco Corporation in 2014 as President and Chief Executive Officer and as a Director from September 2004 to May 2015. From 2004 to 2005, Mr. Quintana served as Tesco's Executive Vice President and Chief Operating Officer. From 1999 to 2004, Mr. Quintana served in various executive roles for Schlumberger Technology Corporation. Prior to joining Schlumberger, Mr. Quintana spent nearly 20 years in the oil and gas exploration and production business in various operational roles for Unocal Corporation. Mr. Quintana holds a Bachelor of Science degree in Mechanical Engineering from the University of Southern California, Los Angeles and is a licensed professional petroleum engineer in the State of California.</p> <p>Mr. Quintana has strong experience in upstream operations, a deep understanding of asset management technologies, and broad human resources management skills and experience.</p>
Susan N. Story Independent Director	<p>Susan N. Story retired from American Water Works Company, Inc. in 2020 as President and Chief Executive Officer. She joined American Water as Senior Vice President and Chief Financial Officer in 2013. Prior to joining American Water, Ms. Story served as Executive Vice President of Southern Company, and in other executive positions with subsidiaries of Southern, including President and Chief Executive Officer of Southern Company Services from 2011 to 2013 and President of Gulf Power Company from 2003 to 2010. Ms. Story holds a Bachelor of Science in Industrial Engineering from Auburn University and a Master of Business Administration from the University of Alabama at Birmingham.</p> <p>Ms. Story has deep knowledge in the areas of finance, operations, cost optimisation and human resources and significant executive leadership experience.</p>

b) Newmont Board interests

As at the Last Practicable Date, the interests of the Newmont Directors are as follows:

1) Shareholding interests in Newmont

The Newmont Directors have the following beneficial ownership interests in Newmont Shares:

Name	Common stock	Restricted Stock, Restricted Stock Units (RSUs) & Director Stock Units (DSUs)	Beneficial Ownership Total
Gregory H. Boyce		37,445 DSUs	37,445
Thomas R. Palmer	142,154	113,885 RSUs	256,039
Patrick G. Awuah Jr.		9,100 DSUs	9,100
Bruce R. Brook	24,933	25,002 DSUs	49,935
Maura J. Clark		11,709 DSUs	11,709
Emma FitzGerald		7,556 DSUs	7,556
Mary A. Laschinger		7,556 DSUs	7,556
José Manuel Madero		9,100 DSUs	9,100
René Médori		20,292 DSUs	20,292
Jane Nelson		49,935 DSUs	49,935
Julio M. Quintana		37,445 DSUs	37,445
Susan N. Story		10,585 DSUs	10,585

2) Fees or benefits given or agreed to be given in connection with the Scheme

No fees or benefits have been given or agreed to be given to any Newmont Director of Newmont in connection with the Scheme.

3) Material contracts with directors

The Newmont Board has determined that all current members of the Newmont Board, other than the President and the Chief Executive Officer (Mr. Thomas R. Palmer, who is an executive director), are independent.

In making this determination, the Newmont Board considered the following circumstances. Mr. Brook serves as a non-executive director at Incitec Pivot Limited (**IPL**), which, indirectly through its subsidiaries and joint ventures, engages in commercial transactions with Newmont related to the supply of explosives. The relationship with IPL was considered by the Corporate Governance and Nominating Committee and the Newmont Board. The relationship with IPL meets the categorical independence standard, which provides that service as a director of a supplier of goods or services is not considered to be a material relationship for purposes of assessing independence if the annual sales to Newmont are less than \$1 or two percent of the gross revenues or sales of the supplier, whichever is greater. Given that the relationship arises only as a result of Mr. Brook's position as an independent director and that no other financial, personal or other relationship exists that might influence a reasonable person's objectivity, the Corporate Governance and Nominating Committee and the Board determined that the relationship was not material for independence purposes.



6.9 Newmont senior management

a) Profiles

As at the date of this Scheme Booklet, the senior management of Newmont comprises the following individuals:

Name and position	Profile
Thomas R. Palmer President and Chief Executive Officer	See section 6.8.
Robert D. Atkinson Executive Vice President and Chief Operating Officer	Robert D. Atkinson is Executive Vice President and Chief Operating Officer of Newmont, positions he has held since June 2019. ⁵⁰ Prior to joining Newmont, Mr. Atkinson served as Head of Productivity and Technical Support for Rio Tinto from June 2016 to February 2019. He also served as Chief Operating Officer for Rio Tinto's portfolio of copper interests in Mongolia, the United States, Chile and Indonesia from September 2013 to May 2016. Prior to that Mr. Atkinson lead ASX-listed Energy Resources of Australia as Chief Executive and Director from September 2008 to August 2013 and served as General Manager of Weipa Bauxite from June 2005 to August 2008. Mr. Atkinson holds a First Class Honours Bachelor of Mining and Petroleum Engineering from Strathclyde University in Scotland.
Karyn F. Ovelmen Executive Vice President and Chief Financial Officer	Karyn F. Ovelmen is Executive Vice President and Chief Financial Officer of Newmont, positions she has held since May 2023. Ms. Ovelmen has more than 30 years of financial, accounting and operating experience across the energy, manufacturing and distribution industries, including over 12 years in Chief Financial Officer roles and most recently served as a non-executive and independent director of Hess Corporation, including as a member of the Audit Committee, and as a non-executive and independent director of ArcelorMittal since May 2015, including as lead independent director, chair of the Audit & Risk Committee and chair of the Appointment Remuneration and Corporate Governance Committee. Ms. Ovelmen also spent 12 years with PricewaterhouseCoopers, primarily serving energy industry accounts. Ms. Ovelmen holds a Bachelor of Arts degree from the University of Connecticut and is a Certified Public Accountant.
Jennifer Cmil Executive Vice President and Chief People Officer	Jennifer Cmil is Executive Vice President and Chief People Officer of Newmont, positions she has held since October 2019. Ms. Cmil first joined Newmont in 2010 as Senior Director, Human Resources. Prior to joining Newmont, Ms. Cmil held leadership positions in human resources across multiple industries, including Vice President of Human Resources at Level 3 Telecommunications, Senior Human Resources Director at KB Home and Human Resources Partner at Sun Microsystems, where she began her career in 1994. Ms. Cmil holds a Bachelor of Science degree from Syracuse University and a Masters of Industrial and Labor Relations from Cornell University.
Dean Gehring Executive Vice President and Chief Integration Officer	Mr. Gehring is Executive Vice President and Chief Integration Officer of Newmont, positions he has held since May 2023. Mr. Gehring joined Newmont in 2017 as Regional Senior Vice President, South America and was appointed Executive Vice President and Chief Technology Officer since June 2019 after serving as since June 2017. Mr. Gehring served as Executive Vice President and Chief Development Officer – Peru to lead the Newmont's Yanacocha operations and the Sulfides project since July 2022. Prior to joining Newmont, Mr. Gehring served 14 years with Rio Tinto in a variety of executive roles including President and Chief Executive Officer of Rio Tinto Minerals from October 2014 to October 2016. Prior roles also included Global Head of Safety and Security and General Manager of Resource Development for the Oyu Tolgoi mine in Mongolia. Mr. Gehring previously worked as Manager of Technical Services at Freeport's Grasberg mine and held various operational and technical roles with BHP Billiton prior that. Mr. Gehring holds a Bachelor of Science degree in Mining Engineering from the University of Idaho and a Master of Science in Project Management from the University of Aberdeen in Scotland.
Mark D. Ebel Interim Chief Legal Officer	Mark D. Ebel was appointed Interim Chief Legal Officer of Newmont in June 2023, after previously serving as Vice President and Associate General Counsel since June 2019. Mr. Ebel joined Newmont in 2011 and served as Associate General Counsel from 2011 to 2019. He is responsible for M&A, financing and a variety of additional transactional and compliance matters. Prior to joining Newmont, Mr. Ebel was CFO and General Counsel at Eyeris Inc., and Partner at Holland & Hart, LLP. Mr. Ebel holds a J.D. degree from Stanford University and a Bachelor of Arts degree in Mathematics and Political Science from Duke University.

50. Newmont Corporation announced that Ms. Natascha Viljoen will join Newmont as Executive Vice President and Chief Operating Officer at a date to be subsequently determined. Ms. Viljoen is currently expected to join Newmont's Executive Leadership Team effective as of October 2, 2023. Mr. Rob Atkinson is expected to continue reporting directly to Newmont's President and Chief Executive Officer, focused on ensuring a planful transition with Ms. Viljoen and driving strategic initiatives to strengthen Newmont's responsible gold leadership position. For more information, see Newmont's media release 'Newmont Announces Appointment of Mining Veteran Natascha Viljoen as Incoming Chief Operating Officer' dated 15 February 2023, available on Newmont's website at <https://www.newmont.com/investors/news-release/news-details/2023/Newmont-Announces-Appointment-of-Mining-Veteran-Natascha-Viljoen-as-Incoming-Chief-Operating-Officer/default.aspx>.

6. Profile of the Newmont Group

6.9 Newmont senior management *continued*

Name and position	Profile
Peter Toth Executive Vice President and Chief Development Officer	Peter Toth is Executive Vice President and Chief Development Officer of Newmont, positions he has held since June 2023. Mr. Toth joined Newmont in July 2022 as Executive Vice President, Strategic Development and his role was expanded in September 2022 to Executive Vice President and Chief Strategy and Sustainability Officer. Prior to joining Newmont, Mr. Toth worked at Rio Tinto from April 2014, with his last role being Group Executive, Strategy and Development, with accountability for business development/M&A, strategic partnerships, climate and sustainability strategy, closure, and exploration. Mr. Toth has more than 25 years of leadership experience working in the resources industry across various commodities. Mr. Toth has held senior strategic, commercial, and operational roles across Europe, Singapore, Australia and the United Kingdom with Rio Tinto, BHP, and OM Holdings. Mr. Toth holds a Bachelor of Business degree from Monash University, a Graduate Certificate in Management from Deakin University, and a Master of International Business degree from the University of Melbourne, in addition to executive development programs at INSEAD, Stanford and Oxford University.
Aaron Puna Executive Vice President and Chief Technology Officer	Aaron Puna is Executive Vice President and Chief Technology Officer of Newmont, positions he has held since January 2023. Prior to joining Newmont, he served as Chief Executive Officer of Anglo American's copper business in Chile following a series of operating and technical positions within that organisation including as Group Head of Open Pit Mining. Mr. Puna has experience across a diverse range of commodities, and further strengthens Newmont's technical, operational and management capability. Mr. Puna holds a Bachelor of Engineering degree (Mining) from the Ballarat School of Mines in Australia.
Suzanne Retallack Executive Vice President and Chief Safety and Sustainability Officer	Suzanne Retallack joined Newmont in 2019 and was appointed as Executive Vice President and Chief Sustainability Officer of Newmont, in June 2023, after previously serving as Senior Vice President for Health, Safety and Security. Prior to joining Newmont, Ms. Retallack held several senior roles in Health and Safety, Environment and Security within Rio Tinto. She earned her Bachelor of Science degree in Psychology from the University of Western Australia, in addition to a Bachelor of Science in Occupational Therapy and a Master of Business Administration from Curtin University in Australia.

b) Fees or benefits given or agreed to be given in connection with the Scheme

No fees or benefits have been given or agreed to be given to any senior manager of Newmont in connection with the Scheme.

c) Material contracts with executive officers

The Newmont Board has adopted written policies and procedures for approving related person transactions. Any transaction with a related person, other than transactions available to all employees generally or involving aggregate amounts of less than \$120,000, must be approved or ratified by the Newmont Audit Committee, the Leadership Development and Compensation Committee for compensation matters, or disinterested members of the Newmont Board. The policies apply to all executive officers, Newmont Directors and their family members and entities in which any of these individuals has a substantial ownership interest or control.

No transaction with a related person has been approved in accordance with this policy for the year ended 31 December 2022.

6.10 Newmont employee incentive plans and Non-executive directors' stock awards

Newmont currently operates the following incentive plans:

- **Annual incentive program** for executive officers which is a cash plan which rewards eligible executive officers for achievement of short-term strategic objectives which are aligned to Newmont's annual goals and purpose. It offers variable, performance-based cash compensation capped at 200% of the target based on company performance.
- **Long-term incentive program** for executive officers which is an equity-based plan designed to reward executive officers for stock price appreciation and relative company out-performance in comparison to peers over the long-term. It offers variable equity-based compensation tied to company performance in the form of Restricted Stock Units (**RSUs**) and Performance Stock Units (**PSUs**). These equity plans represent a significant portion of the executives' pay mix and are used to create a strong link between individual and company performance and payouts.
- **Non-executive director stock incentive** called the 2020 Stock Incentive Compensation Plan, under which Newmont issues \$180,000 of common stock or director stock units (**DSUs**) to each non-executive Director every year. The fair market value is determined on the first business day following election by the Board or re-election at Newmont's Annual Meeting, or as soon as administratively possible.

RSUs are time-based awards, which vest on a straight-line basis over periods of three years or more, unless the holder becomes retirement eligible prior to the vesting date. Upon vesting, each RSU will convert on a one-on-one basis to Newmont common stock.

Similar to an RSU, a PSU represents one share of Newmont common stock, but has both time-based and performance-based vesting requirements to align executive compensation to long-term performance. PSU grants are measured based on the results of the three-year performance period.

Prior to vesting, holders of RSUs and PSUs do not have the right to vote the underlying shares; however, RSUs and PSUs are eligible for accrued dividends. Dividends will accrue on Newmont RSU and PSU awards from the date of grant through their vest date, with payment upon vesting. The accrued dividend equivalents are not paid if the awards are forfeited.

DSUs represent the right to receive shares of common stock and are immediately fully vested and non-forfeitable. The holders of DSUs do not have the right to vote the underlying shares; however, the DSUs accrue dividend equivalents, which are paid at the time the common shares are issued. Upon retirement from the Board of Directors, the holder of DSUs is entitled to receive one share of common stock for each DSU.



6.11 Recent Newmont Share price history

The following chart shows the performance of Newmont Shares on NYSE over the last 12 months.

60.0 US\$/sh



At the close of trading on NYSE on the Last Practicable Date:

- the last recorded trading price of Newmont Shares on NYSE was \$39.32; and
- the lowest and highest closing prices of Newmont Shares during the previous three months were \$38.20 and \$45.47 respectively.

As at 3 February 2023, being the last trading day prior to the announcement of Newmont's initial proposal for Newcrest, the undisturbed closing price of Newmont Shares on NYSE was \$49.85.

As at 12 May 2023, being the last trading day before Newcrest and Newmont publicly announced that they had entered into the Scheme Implementation Deed, the closing price of Newmont Shares on NYSE was \$45.94.

6.12 Rationale for proposed acquisition of Newcrest

There are four key pillars to Newmont's rationale for the Scheme, which will benefit shareholders of both companies:

- **The New Sustainability Standard:** Newmont will apply its proven leading sustainability practices to bring clear focus on mitigating safety risks; meaningful social engagement in order to be a partner of choice; commitment to leading and environment stewardship practices and climate goals; and a diverse, inclusive and equitable workplace.
- **World-Class Portfolio:** The combined portfolio will have the industry's highest concentration of Tier 1 gold assets⁵¹ primarily in favourable, low-risk mining jurisdictions, as well as the industry's largest gold reserve and resource base.⁵² The high quality production portfolio alongside an extensive portfolio of greenfield and brownfield growth options and a meaningful increase in copper reserves will position the Merged Group to drive strong, stable and lasting returns over many decades.
- **Delivering Synergies:** Newmont's scalable, integrated operating model is expected to support the anticipated delivery of approximately \$500 in annual pre-tax synergies within 24 months of implementing the Scheme, leveraging Newmont's integration experience from the 2019 acquisition of Goldcorp Inc.⁵³ Further value creation opportunities are anticipated over time as the transaction brings together key talent and processes in complementary jurisdictions and ore bodies, including, among other things, the benefits from the experience of Newcrest's world-class block caving team.
- **Driving Capital Allocation:** The Merged Group will remain committed to its capital allocation strategy, which is underpinned by a strong and flexible investment grade balance sheet. Together with the sector's largest reserve and resource base, and even stronger, lower cost, diversified portfolio, the Merged Group can advance its most value-accretive development opportunities while remaining committed to Newmont's industry-leading, non-binding dividend framework to drive leading returns through the price cycle.⁵⁴

On this basis, the Newmont Board is confident in Newmont's ability to continue to deliver sector leading returns for the benefit of all of Newmont's and Newcrest's shareholders going forward.

See also section 1.3 for further information regarding the merits and strategic rationale of the Scheme.

51. A Tier 1 asset is defined by Newmont as +500k gold equivalent ounces/year consolidated, average AISC/oz in the lower half of the industry cost curve and a mine life >10 years in countries that are classified in the A and B rating ranges for each of Moody's, S&P and Fitch.

52. Comprising Newmont's Subpart 1300 resources and reserves (see section 5.5 for more information) and Newcrest's JORC reserves and resources (see section 6.4 for more information).

53. Refer to section 8.2(b) for information regarding the risks associated with the Merged Group achieving the anticipated synergies.

54. Refer to sections 6.7 and 7.3(d) for further details on Newmont's non-binding dividend framework.

6. Profile of the Newmont Group

6.13 Corporate governance

a) Overview

Newmont's corporate governance framework is underpinned by its Corporate Governance Guidelines and the charters and key practices of its Board committees. Full copies of Newmont's corporate governance documents can be found on Newmont's website at www.newmont.com/about-us/governance-and-ethics.

b) Newmont Board

The highest level of oversight at Newmont resides with the Newmont Board. The Newmont Board plays a critical role overseeing Newmont's business strategy and the overall goal of delivering long-term value creation for Newmont Stockholders and other stakeholders.

The Newmont Directors bring a broad range of backgrounds, experiences and talents, along with ethnic, racial and gender diversity to Newmont's governance process. As at 30 June 2023, the Newmont Board was comprised of 12 directors (11 independent non-executive directors and one executive director) with more than 70% of the independent directors with a form of ethnic, racial or gender diversity to the Newmont Board, with 45% female representation among independent directors.

All Newmont Board committee members are independent directors.

Newmont's Corporate Governance Guidelines set out the following guidelines for Board governance:

Director qualifications	Newmont directors should possess the following minimum qualifications: <ul style="list-style-type: none">– the highest personal and professional ethics, integrity and values;– commitment to representing the long-term interest of Newmont stockholders;– broad experience at the policy-making level in business, government, education, technology or public interest; and– sufficient time to effectively fulfil their duties as a Newmont Board member.
Independence	The Newmont Board will have a substantial majority (75% or more) of directors who meet the criteria for independence required by NYSE and any applicable laws, rules, regulations or guidelines.
Board size	Newmont's by-laws specify that the Newmont Board may be composed of between eight and 17 directors.
Board composition	The Newmont Board considers skills, qualifications and diversity in deciding on nominees. When evaluating candidates, the Corporate Governance and Nominating Committee (the Governance Committee) considers a broad range of diversity, including diversity in terms of professional experience, skills and background, as well as diversity of domicile, nationality, race and gender. Newmont's Governance Committee and the Newmont Board review the appropriate skills and characteristics required of Board members in the context of the current make-up of the Newmont Board and any perceived needs on an annual basis.
Director election	Directors are elected each year by Newmont Stockholders at the annual meeting of stockholders. The Newmont Board will propose nominees to the Newmont Stockholders for election to the Newmont Board.
Chair	The Newmont Board elects a Non-Executive Chair on an annual basis from Newmont's independent directors. The Non-Executive Chair is responsible for the leadership, management, development and effective functioning of the Newmont Board.



6.13 Corporate governance *continued*

c) Newmont Board committees

The Newmont Board is assisted in carrying out its responsibilities by four core Board committees: the Audit Committee, the Corporate Governance and Nominating Committee, the Leadership Development and Compensation Committee and the Safety and Sustainability Committee:

1) Audit Committee

Newmont's Audit Committee's responsibilities include providing oversight of the integrity of Newmont's financial statements and compliance with legal and regulatory requirements and corporate policies and controls. This includes reviewing Newmont's Business Integrity and Compliance program and charter and evaluating and approving any material changes to Newmont's Code of Conduct. In addition to annual and quarterly financial reporting, the Audit Committee also provides oversight of Newmont's Taxes and Royalties Contribution Report, which discloses Newmont's tax strategy and significant economic contributions to host communities and governments as part of Newmont's commitment to creating shared value.

2) Corporate Governance and Nominating Committee

Newmont's Corporate Governance and Nominating Committee's responsibilities include ensuring that the Newmont Board is composed of qualified individuals who will serve in the best interests of Newmont Stockholders and key stakeholders. This includes providing oversight and advice on corporate governance issues, Newmont Board leadership and succession planning.

3) Leadership Development and Compensation Committee

Newmont's Leadership Development and Compensation Committee has the responsibility to develop and oversee Newmont's executive compensation policies and programs. This includes ensuring executives are held accountable for Newmont's health, safety and sustainability performance through an effective performance-based compensation structure. The Leadership Development and Compensation Committee also oversees leadership development, succession planning and talent management, and the global inclusion and diversity approach. The Leadership Development and Compensation Committee reviews Newmont's People Strategy and oversees the efforts to create a more diverse and inclusive workplace.

4) Safety and Sustainability Committee

Newmont's Safety and Sustainability Committee provides advice and oversight on Newmont's efforts to adopt practices in the promotion of a healthy and safe work environment, and environmentally sound and socially responsible mining and resource development.

The Safety and Sustainability Committee provides oversight of matters relating to health, safety, loss prevention and operational security, sustainable development, environmental management and affairs, relations with communities and civil society, government relations, human rights, cultural heritage and related risks.

The Safety and Sustainability Committee's meetings include in-depth discussions on policies, standards and strategies designed to mitigate safety and sustainability risks, compliance with regulations and policies; performance against standards, internal and external commitments and public targets; and the associated review of ESG-related incentive plan metrics. The Safety and Sustainability Committee provides input on Newmont's annual materiality assessment to identify sustainability risks and concerns, and reviews and approves Newmont's Annual Sustainability Report and Climate Report.

In addition to the four core board committees listed above, Newmont's by-laws also establish the authority of the Executive-Finance Committee to support the Newmont Board in execution of its duties and responsibilities. The Executive-Finance Committee meets on an as needed basis and performs transaction, expense and project reviews and also provides administrative approvals between regular meetings of the Newmont Board.

6.14 Financing arrangements

Newmont believes its existing consolidated cash and cash equivalents, time deposits, available capacity on its revolving credit facility, and cash generated from continuing operations will be adequate to satisfy working capital needs, fund future growth, meet debt obligations and meet other liquidity requirements for the foreseeable future. At 30 June 2023, Newmont's borrowing capacity on its revolving credit facility was \$3,000, and Newmont had no borrowings outstanding under the revolving credit facility. As at the date of this Scheme Booklet, Newmont continues to remain compliant with covenants and does not currently anticipate any events or circumstances that would impact Newmont's ability to access funds available on this facility.

6. Profile of the Newmont Group

6.15 Historical financial information of Newmont

a) Overview

The historical financial information of the Newmont Group set out in this section 6.15 comprises:

- Newmont historical consolidated statements of operations for the six months ended 30 June 2023 and years ended 31 December 2022 (CY22) and 31 December 2021 (CY21) (**Newmont Historical Statements of Operations**);
- Newmont historical consolidated balance sheet as at 30 June 2023 (**Newmont Historical Balance Sheet**); and
- Newmont historical consolidated statements of cash flows for the six months ended 30 June 2023 and CY22 and CY21 (**Newmont Historical Statements of Cash Flows**),

(collectively, the **Newmont Historical Financial Information**).

The Newmont Historical Financial Information has been reviewed by Ernst & Young Strategy and Transactions Limited (as Investigating Accountant), in accordance with the Australian Standard on Assurance Engagements ASAE 3450 *Assurance Engagements involving Corporate Fundraisings and/or Prospective Financial Information*, as stated in its Independent Limited Assurance Report, included in Annexure 2. Newcrest Shareholders should note the scope and limitations of the Independent Limited Assurance Report.

The Newmont Group's consolidated financial statements, including all notes to those consolidated financial statements and a description of the Newmont Group's significant accounting policies can be found in:

- the historical unaudited consolidated financial statements of Newmont for the six months ended 30 June 2023 included in Newmont's Quarterly Report on Form 10-Q, filed with the SEC on 20 July 2023; and
- the historical audited consolidated financial statements of Newmont for the years ended 31 December 2022 and 2021, included in the Newmont Annual Report for the year ended 31 December 2022, filed with the SEC on 23 February 2023, as updated by Newmont's Current Report on Form 8-K, filed with the SEC on 20 July 2023.

The full reports are available on Newmont's website at www.newmont.com.

This section 6.15 should be read in conjunction with the risks to which Newmont is subject and the risks associated with the Scheme, as set out in section 8.

b) Basis of preparation

The Newmont Historical Financial Information is intended to present Newcrest Shareholders with information to assist them in understanding the historical financial performance, financial position and cash flows of the Newmont Group. Newmont management is responsible for the preparation and presentation of the Newmont Historical Financial Information.

The Newmont Historical Financial Information has been prepared on a going concern basis, which assumes continuity of normal business activities and the realisation of assets and the settlement of liabilities in the ordinary course of business.

The Newmont Historical Financial Information has been prepared in a manner consistent with Newmont Group accounting policies applied by Newmont in preparing the Newmont Quarterly Report for the quarter ended 30 June 2023 and the Annual Report for the year ended 31 December 2022. The accounting principles used in the preparation of the Newmont Historical Financial Information are consistent with those set out in Newmont's Quarterly Report for the quarter ended 30 June 2023 and the Annual Report for the year ended 31 December 2022.

The Newmont Historical Financial Information for the years ended 31 December 2021 and 31 December 2022 has been derived from the Newmont Group's consolidated financial statements prepared for the Newmont Annual Reports for the respective years, as updated by Newmont's Current Report on Form 8-K, filed with the SEC on 20 July 2023. These consolidated financial statements were prepared in accordance with United States Generally Accepted Accounting Principles (**US GAAP**). Newmont Group's consolidated financial statements for the years ended 31 December 2021 and 31 December 2022 were audited by Ernst & Young LLP, Independent Registered Public Accounting Firm for Newmont, in accordance with the standards of the Public Company Accounting Oversight Board (United States) and they issued unqualified audit opinions on these consolidated financial statements. The auditor's report issued by Ernst & Young LLP notes that the financial statements of Nevada Gold Mines LLC, in which Newmont has a 38.5% owned investment and which is proportionately consolidated into Newmont, were audited by other auditors and Ernst & Young LLP's audit opinions, insofar as it relates to the amounts included for Nevada Gold Mines LLC, is based solely on the reports of the other auditors.

The Newmont Historical Financial Information as at and for the six months ended 30 June 2023 has been derived from the Newmont Group's interim consolidated financial statements prepared for the Newmont 10-Q Quarterly Report for the quarter ended 30 June 2023. These interim consolidated financial statements in Newmont's 10-Q Quarterly Report were prepared in accordance with US GAAP and the applicable rules and regulations of the SEC for interim financial information. Accordingly, they do not include all of the information and footnotes required by US GAAP for full financial statements. Ernst & Young LLP performs reviews of the Newmont Group's interim consolidated financial statements filed with the SEC in accordance with the standards of the Public Company Accounting Oversight Board (United States).

The Newmont Historical Financial Information is presented in USD and unless otherwise noted, is rounded to nearest USD millions.

The Newmont Historical Financial Information is presented in an abbreviated form insofar as it does not include all the presentation, disclosures, statements, or comparative information that is required by US GAAP applicable to full financial statements or financial statements prepared in accordance with the applicable rules and regulations of the SEC.

6.15 Historical financial information of Newmont continued

c) Newmont Historical Statements of Operations

Table 6.15.1 Newmont Historical Statements of Operations

Newmont Historical Statements of Operations for the six months ended 30 June 2023, the year ended 31 December 2022 and the year ended 31 December 2021 are set out in the table below.

	Six months ended 30 June 2023 \$ millions	Year ended 31 December 2022 \$ millions	Year ended 31 December 2021 \$ millions
Sales	5,362	11,915	12,222
Costs and expenses:			
Costs applicable to sales ¹	3,025	6,468	5,435
Depreciation and amortisation	947	2,185	2,323
Reclamation and remediation	132	921	1,846
Exploration	114	231	209
Advanced projects, research and development	79	229	154
General and administrative	145	276	259
Impairment charges ²	—	1,320	25
Loss on assets held for sale	—	—	571
Other expense, net	49	82	143
	4,491	11,712	10,965
Other income (expense):			
Gain on asset and investment sales, net	—	35	212
Other income (loss), net ³	82	(62)	(87)
Interest expense, net of capitalised interest	(114)	(227)	(274)
	(32)	(254)	(149)
Income/ (loss) before income and mining tax and other items	839	(51)	1,108
Income and mining tax benefit (expense)	(376)	(455)	(1,098)
Equity income (loss) of affiliates	41	107	166
Net income (loss) from continuing operations	504	(399)	176
Net income (loss) from discontinued operations	14	30	57
Net income (loss)	518	(369)	233
Net loss (income) attributable to non-controlling interests	(12)	(60)	933
Net income (loss) attributable to Newmont stockholders	506	(429)	1,166

Notes:

1. Excludes Depreciation and amortisation and Reclamation and remediation.
2. For the six months ended 30 June 2023, *Impairment charges*, included in *Other expense, net*, were \$8.
3. Includes \$36 related to *Gain on asset and investment sales, net* for the six months ended 30 June 2023.

6. Profile of the Newmont Group

6.15 Historical financial information of Newmont continued

d) Newmont Historical Balance Sheet

Table 6.15.2 Newmont Historical Balance Sheet

Newmont Historical Balance Sheet as at 30 June 2023 is set out in the table below.

	30 June 2023
	\$ millions
Assets	
Cash and cash equivalents	2,829
Time deposits and other investments	409
Trade receivables	185
Inventories	1,111
Stockpiles and ore on leach pads	858
Other current assets	742
Current assets	6,134
Property, plant and mine development, net	24,284
Investments	3,172
Stockpiles and ore on leach pads	1,737
Deferred income tax assets	166
Goodwill	1,971
Other non-current assets	669
Total assets	38,133
Liabilities	
Accounts payable	565
Employee-related benefits	313
Income and mining taxes	155
Lease and other financing obligations	96
Other current liabilities	1,564
Current liabilities	2,693
Debt	5,574
Lease and other financing obligations	441
Reclamation and remediation liabilities	6,604
Deferred income tax liabilities	1,795
Employee-related benefits	399
Silver streaming agreement	786
Other non-current liabilities	426
Total liabilities	18,718
Equity	
Common stock	1,281
Treasury stock	(261)
Additional paid-in capital	17,407
Accumulated other comprehensive income (loss)	13
Retained earnings (accumulated deficit)	785
Newmont stockholders' equity	19,225
Noncontrolling interests	190
Total equity	19,415
Total liabilities and equity	38,133

6.15 Historical financial information of Newmont continued

e) Newmont Historical Statements of Cash Flows

Table 6.15.3 Newmont Historical Statements of Cash Flows

Newmont Historical Statements of Cash Flows for the six months ended 30 June 2023, the year ended 31 December 2022 and the year ended 31 December 2021 are set out in the table below.

	Six months ended 30 June 2023 \$ millions	Year ended 31 December 2022 \$ millions	Year ended 31 December 2021 \$ millions
Operating activities:			
Net income (loss)	518	(369)	233
Non-cash adjustments:			
Depreciation and amortisation	947	2,185	2,323
Impairment charges	—	1,320	25
Loss on assets held for sale	—	—	571
(Gain) loss on asset and investment sales, net	(36)	(35)	(212)
Net loss (income) from discontinued operations	(14)	(30)	(57)
Reclamation and remediation	120	892	1,827
Charges from pension settlement	—	137	4
Stock-based compensation	42	73	72
Deferred income taxes	21	(278)	(109)
Change in fair value of investments	1	46	135
Other non-cash adjustments ¹	7	98	(5)
Net change in operating assets and liabilities	(469)	(841)	(541)
Net cash provided by (used in) operating activities of continuing operations	1,137	3,198	4,266
Net cash provided by (used in) operating activities of discontinued operations	7	22	13
Net cash provided by (used in) operating activities	1,144	3,220	4,279
Investing activities:			
Additions to property, plant & mine development	(1,142)	(2,131)	(1,653)
Purchases of investments	(542)	(940)	(59)
Contributions to equity method investees	(64)	(194)	(150)
Proceeds from asset and investment sales	214	171	194
Proceeds from maturities of investments	981	93	—
Return of investment from equity method investees	30	62	18
Acquisitions, net ²	—	(15)	(328)
Proceeds from sales of mining operations and other assets, net	—	16	84
Other	23	(45)	26
Net cash provided by (used in) investing activities	(500)	(2,983)	(1,868)

TABLE 6.15.3 CONTINUES ON NEXT PAGE

6. Profile of the Newmont Group

6.15 Historical financial information of Newmont continued

Table 6.15.3 Newmont Historical Statements of Cash Flows continued

	Six months ended 30 June 2023 \$ millions	Year ended 31 December 2022 \$ millions	Year ended 31 December 2021 \$ millions
Financing activities:			
Dividends paid to common stockholders	(636)	(1,746)	(1,757)
Acquisition of noncontrolling interests	—	(348)	—
Distribution to noncontrolling interests	(66)	(191)	(200)
Funding from noncontrolling interests	75	117	100
Repayment of debt	—	(89)	(1,382)
Payments of lease and other financing obligations	(32)	(66)	(73)
Payments for withholding of employee taxes related to stock-based compensation	(22)	(39)	(32)
Proceeds from issuance of debt, net	—	—	992
Repurchases of common stock	—	—	(525)
Other	(3)	6	(81)
Net cash provided by (used in) financing activities	(684)	(2,356)	(2,958)
Effect of exchange rate changes on cash, cash equivalents and restricted cash	(4)	(30)	(8)
Net change in cash, cash equivalents and restricted cash	(44)	(2,149)	(555)
Cash, cash equivalents and restricted cash at beginning of period	2,944	5,093	5,648
Cash, cash equivalents and restricted cash at end of period	2,900	2,944	5,093

Notes:

1. Includes \$8 of Impairment Charges for the six months ended 30 June 2023.
2. *Acquisitions, net* for the year ended 31 December 2021 is primarily related to the asset acquisition of the remaining 85.1% of GT Gold Corp.

6.16 Material changes in financial position (since 30 June 2023)

To the knowledge of the Newmont Directors, there have been no material changes to the financial position of Newmont and the Newmont Group since 30 June 2023.

6.17 Capital structure

As at the Last Practicable Date, the capital structure of Newmont was:

Type of security	Number on issue
Newmont shares	794,795,993 common shares outstanding 6,011,122 treasury shares 800,807,115 total issued (inclusive of treasury shares)
Newmont Equity Incentives	2,141,021 shares in connection with Restricted Stock Units (RSUs) awarded but subject to vesting (other than 225,725 Deferred Stock Units (DSUs), which are fully vested, entitling holders to receive one share of Newmont common stock upon retirement from the Board of Directors) 1,253,707 shares based on Performance Share Unit (PSU) target set (assuming 100% of targets; but subject to performance and not yet formally awarded as RSUs)



6.18 Substantial holders

As at the Last Practicable Date,⁵⁵ the substantial shareholders of Newmont Shares were:

Substantial holder	Number of Newmont Shares	Voting power in Newmont
Blackrock, Inc.	92,123,660	11.6%
The Vanguard Group Inc.	69,210,466	8.72%
State Street Corporation	40,484,102	5.10%

6.19 Newmont's interests in Newcrest Shares

a) Interests in Newcrest Shares

As at the Last Practicable Date, none of Newmont or any of its Associates had any Relevant Interest or voting power in any Newcrest Shares.⁵⁶

b) No dealings in Newcrest Shares in previous four months

None of Newmont or any of its Associates has provided, or agreed to provide, consideration for Newcrest Shares under any purchase or agreement during the four months before the date of this Scheme Booklet.

c) No inducing benefits given during previous four months

During the period of four months before the date of this Scheme Booklet, none of Newmont or any of its Associates gave, or offered to give, or agreed to give a benefit to another person which was likely to induce the other person, or an Associate of the other person, to:

- vote in favour of the Scheme; or
- dispose of Newcrest Shares,

where the benefit was not offered to all Newcrest Shareholders.

d) Benefits to current Newcrest officers

Other than as disclosed in this Scheme Booklet, none of Newmont or any of its associates will be making any payment or giving any benefit to any current director, secretary or executive officer of Newcrest or any of its related bodies corporate as compensation or consideration for, or otherwise in connection with, their resignation from their respective offices if the Scheme is implemented.

6.20 No other material information

Other than as disclosed in this section 6 and in this Scheme Booklet generally, there is no information regarding Newmont, or its intentions regarding Newcrest, that is material to the making of a decision by a Newcrest Shareholder on whether or not to vote in favour of the Scheme that is within the knowledge of any director of Newmont as at the date of this Scheme Booklet that has not been previously disclosed to Newcrest Shareholders.

55. Based solely on information contained in the most recent filed Schedule 13G/A of each of BlackRock, Inc., The Vanguard Group, and State Street Corporation filed with the SEC on 27 January 2023, on 9 February 2023 and on 7 February 2023, respectively, each reflecting beneficial ownership as of 31 December 2022.

56. For completeness, Ms. Story is the holder of a separately managed account in which 128 Newcrest Shares are held, but Ms. Story does not have the power to vote or dispose of, or to cause the voting or disposal of, those Newcrest Shares or otherwise direct investments within such account.

7. Profile of the Merged Group

This section 7 contains information in relation to the Merged Group if the Scheme is implemented.

7.1 Overview of the Merged Group

If the Scheme is implemented, Newcrest will become a wholly owned indirect Subsidiary of Newmont, and Newmont will add Newcrest's gold mining assets to its world leading portfolio.

Following implementation of the Scheme, Newmont will focus on its strategic objectives to create value for all shareholders and stakeholders to deliver superior operational execution, sustain a global portfolio of long-life assets and lead the gold sector in profitability and responsibility.

7.2 Synergies

Newmont believes that the addition of the Newcrest assets to its existing portfolio combines two world-class companies with meaningful overlap in key gold and copper mining jurisdictions in Australia and Canada, which will provide the Merged Group with the ability to unlock significant strategic and operational synergies.

Leveraging experience from Newmont's acquisition of Goldcorp in 2019, the Newmont management team has experience integrating assets and identifying and delivering synergy results. Based upon that proven experience and due diligence assessments of Newcrest's assets, Newmont has identified value creation opportunities from scale, cost efficiencies and access to top talent, as well as the potential for productivity gains from technology, complementary ore body experience and functional excellence.

Newmont believes that the complementary businesses of Newmont and Newcrest will position the Merged Group to deliver estimated annual pre-tax synergies of approximately \$500 million within the first 24 months following implementation of the Scheme.⁵⁷ As set out in figure 1 below, expected synergies for the Merged Group are comprised of:

- **General and administrative (G&A):** Approximately \$100 million of pre-tax general and administrative synergies driven by Newmont's scalable, integrated operating model with existing regional teams in Australia and Canada.
- **Supply Chain:** Approximately \$200 million of supply chain synergies from best-in-class pricing and existing strong partnerships with key suppliers, smelters and equipment manufacturers through increased economies of scale.
- **Full Potential Improvements:** Approximately \$200 million of benefits from Newmont's full potential continuous improvement program, which improves costs and productivity through replication of leading processes and advanced technology.

Figure 1: Expected annual synergies of the Merged Group

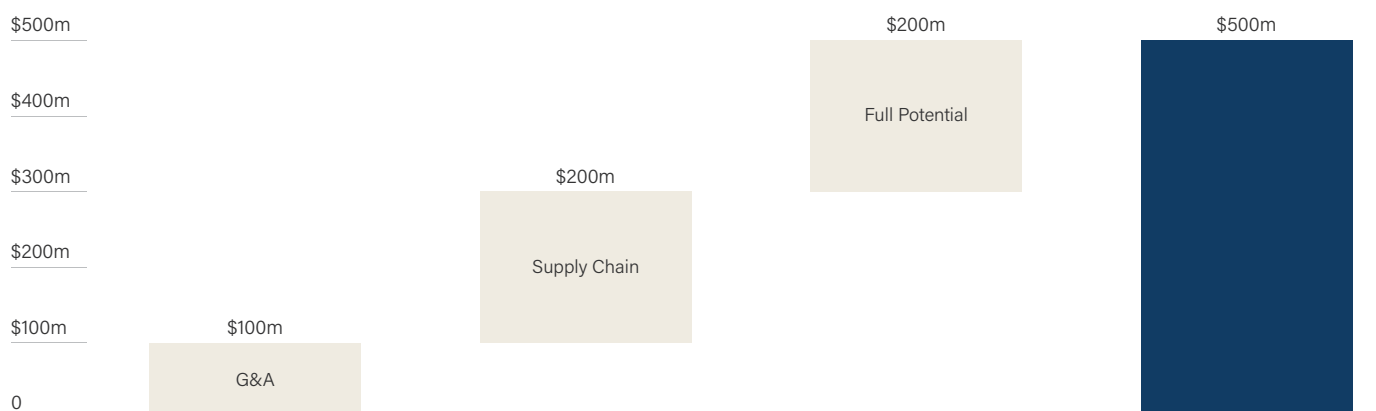

\$500m of Annual Synergies Expected Within 24 Months

Newmont also believes that the Merged Group will have the opportunity to enhance near-term cash flows, and plans to target at least \$2 billion in incremental cash flow in the first two years following implementation of the Scheme through portfolio optimisation, based upon a combination of project re sequencing and divestitures.

These expected synergies have been identified by Newmont and are the responsibility of Newmont. Newcrest and its officers and advisers do not assume any responsibility for any statement relating to synergies expected to be realised by Newmont as a result of the Scheme.

57. Refer to section 8.2(b) for information regarding the risks associated with the Merged Group achieving the anticipated synergies.

7.3 Newmont's intentions

a) Overview

This section 7.3 sets out Newmont's current intentions in relation to Newcrest and the Merged Group if the Scheme is implemented.

b) Corporate structure

If the Scheme is implemented:

- Newmont Overseas will become the holder of all Newcrest Shares;
- Newcrest will become a wholly owned indirect Subsidiary of Newmont; and
- Newcrest will apply to be removed from the ASX, TSX and PNGX.

c) Strategy

Newmont's ongoing strategy will be to create value for all Newmont Stockholders and stakeholders through efforts to:

- **Deliver superior operational execution** by ensuring fatality risks are managed at all times with strong leadership and systems, continually improving operational performance and meeting commitments without fail.
- **Sustain a global portfolio of long-life assets** by growing margins, reserves and resources from profitable expansions, exploration and value accretive investments.
- **Lead the gold sector in profitability and responsibility** by consistently generating superior returns, demonstrating Newmont's values, and leading in environmental, social and governance performance.

d) Dividend framework

It is expected that Newmont's current dividend framework, as outlined in section 6.7, will be the dividend framework of the Merged Group, following implementation of the Scheme.⁵⁸

e) Current Newcrest employees

Newcrest's existing workforce is expected to join Newmont's employees following implementation of Scheme, subject to arrangements regarding the composition of the Merged Group Board and senior management, as set out in section 7.4.

In due course following implementation of the Scheme, Newmont intends to conduct a comprehensive review of employees to determine suitability for roles in the Merged Group. Employees that are not offered employment within the Merged Group will receive their full contractual and statutory entitlements, which would be paid from Newmont's cash reserves.

f) Employee incentive arrangements

Newcrest's existing employee incentive plans will no longer be applicable following implementation of the Scheme. Newmont intends to continue utilising its existing incentive arrangements to provide incentives to its employees, as described in section 6.10.

g) Delisting

1) ASX

If the Scheme is implemented, Newcrest will request to be removed from the Official List of the ASX. Following its delisting from the ASX, Newcrest Shareholders will no longer be able to acquire or trade in Newcrest Shares on the ASX.

2) PNGX

If the Scheme is implemented, Newcrest will also apply for the termination of the official quotation of Newcrest Shares on the PNGX and for Newcrest to be removed from PNGX.

3) TSX

If the Scheme is implemented, Newcrest will also apply for the termination of the official quotation of Newcrest Shares on TSX and for Newcrest to be removed from TSX.

h) Headquarters

If the Scheme is implemented, the Merged Group's corporate operations will be headquartered at Newmont's corporate offices in Denver, Colorado (United States). Newmont intends to conduct a review of the Merged Group's Australian offices following implementation of the Scheme to determine the optimal Australian office arrangements for the Merged Group.

58. Newmont's future dividends have not yet been approved or declared by the Newmont Board. The dividend framework is non-binding and an annualised dividend payout level has not been declared by the Board. Newmont's dividend framework and expected 2023 dividend payout ranges are non-binding and do not represent a legal commitment. Future dividends beyond the dividend payable on 21 September 2023 to holders of record at the close of business on 7 September 2023 have not yet been approved or declared by the Newmont board of directors. Newmont management's expectations with respect to future dividends, annualised dividends, payout ranges or dividend yield are "forward-looking statements". The declaration and payment of future dividends remain at the discretion of the Newmont Board and will be determined based on Newmont's financial results, balance sheet strength, cash and liquidity requirements, future prospects, gold and commodity prices, and other factors deemed relevant by the Board. The duration, scope and impact of COVID-19 presents additional uncertainties with respect to future dividends and no assurance is being provided that Newmont will pay future dividends at the increased payment level. The Newmont Board periodically reviews and assesses this non-binding dividend framework and reserves all powers related to the declaration and payment of dividends. Consequently, in determining the dividends to be declared and paid on Newmont Shares, the Newmont Board may revise or terminate the payment level at any time without prior notice.

7. Profile of the Merged Group

7.4 Board and management

a) Board

1) Existing Newmont Directors

It is expected that each of the existing Newmont Directors will continue as directors following implementation of the Scheme. See section 6.8 for further details of the Newmont Directors.

2) Newcrest Directors appointed to the Merged Group Board

If the Scheme is implemented, Newmont will invite two current Newcrest Directors to join the Newmont Board on similar terms as Newmont's existing non-executive directors as set out in section 6.8.

b) Management

It is expected that the existing members of Newmont's senior leadership team will continue following implementation of the Scheme. See section 6.9 for further details of Newmont's senior management.

7.5 Resources and reserves

Details of Newcrest's resources and reserves are set out in section 5.5.

Details of Newmont's resources and reserves are set out in section 6.4.

7.6 Capital structure

a) Share capital

The table below summarises the shares that will be on issue in the Merged Group on the Implementation Date:

Timing	Number
On issue as at the date of this Scheme Booklet	794,795,993 ¹
To be issued under the Scheme	357,692,293 ²
Pro forma	1,152,488,286

Notes:

1. Excluding treasury shares. See section 6.17 for details regarding the treasury shares on issue.
2. Based on 894,230,732 Newcrest Shares on issue as at the date of this Scheme Booklet (see section 5.11) and the fixed exchange ratio of 0.400 Newmont Securities for each Newcrest Share held.

b) Pro forma ownership

On the Implementation Date, Newcrest Shareholders will own approximately 31.1% of the Merged Group (including Newmont Shares to be issued to the Sale Agent that would otherwise be issued to Ineligible Foreign Shareholders).

7.7 Pro forma historical financial information of the Merged Group

a) Overview

This section 7.7 contains the pro forma historical financial information of the Merged Group (**Merged Group Pro Forma Historical Financial Information**) comprising the:

- Merged Group pro forma historical statements of operations for the six months ended 30 June 2023 and the year ended 31 December 2022 (**Merged Group Pro Forma Historical Statements of Operations**), as set out in section 7.7(c); and
- Merged Group pro forma historical balance sheet as at 30 June 2023 (**Merged Group Pro Forma Historical Balance Sheet**), as set out in section 7.7(d).

The Merged Group Pro Forma Historical Financial Information has been reviewed by Ernst & Young Strategy and Transactions Limited (as Investigating Accountant), in accordance with the Australian Standard on Assurance Engagements ASAE 3450 Assurance Engagements involving Corporate Fundraisings and/or Prospective Financial Information, as stated in its Independent Limited Assurance Report included in Annexure 2. Newcrest Shareholders should note the scope and limitations of the Independent Limited Assurance Report.

The Merged Group Pro Forma Historical Financial Information is based on and should be read in conjunction with:

- the accompanying notes to the Merged Group Pro Forma Historical Financial Information;
- the Newcrest Historical Financial Information presented in section 5.8; and
- the Newmont Historical Financial Information presented in section 6.15.

This section 7.7 should also be read in conjunction with the risks to which Newmont and the Merged Group are subject and the risks associated with the Scheme, as set out in section 8.



7.7 Pro forma historical financial information of the Merged Group continued

b) Basis of preparation

The Merged Group Pro Forma Historical Financial Information included in this section 7.7 is intended to present Newcrest Shareholders with information to assist them in understanding the pro forma historical financial performance and financial position of the Merged Group. Newmont management is responsible for the preparation and presentation of the Merged Group Pro Forma Historical Financial Information.

The Merged Group Pro Forma Historical Financial Information has been prepared on a going concern basis, which assumes continuity of normal business activities and the realisation of assets and the settlement of liabilities in the ordinary course of business.

The Merged Group Pro Forma Historical Financial Information has been prepared in a manner consistent with Newmont Group accounting policies applied by Newmont in preparing the Newmont Quarterly Report for the quarter ended 30 June 2023 and the Annual Report for the year ended 31 December 2022, using the assumptions set out in section 7.7(e).

The accounting principles used in the preparation of the Merged Group Pro Forma Historical Financial Information are consistent with those set out in the Newmont Quarterly Report for the quarter ended 30 June 2023 and the Newmont Annual Report for the year ended 31 December 2022.

The Merged Group Pro Forma Historical Financial Information presents the combination of the Newmont Historical Financial Information and the Newcrest Historical Financial Information after giving effect to the Scheme which is assumed to have occurred on:

- 1 January 2022 for the Merged Group Pro Forma Historical Statements of Operations; and
- as at 30 June 2023 for the Merged Group Pro Forma Historical Balance Sheet.

As discussed in section 5.8, the consolidated financial statements for Newcrest for the years ended 30 June 2022 and 30 June 2023 have been audited by Newcrest's auditor, Ernst & Young. Ernst & Young also performed a review of Newcrest's interim consolidated financial statements for the six months ended 31 December 2021 and 31 December 2022 and on which unqualified limited assurance conclusions were issued. As further discussed in section 6.15, the consolidated financial statements for Newmont for the year ended 31 December 2022 were audited by Ernst & Young LLP, Independent Registered Public Accounting Firm for Newmont. Ernst & Young LLP performs reviews of Newmont's interim consolidated financial statements filed with the SEC in accordance with standards of the Public Company Accounting Oversight Board (United States).

The Merged Group Pro Forma Historical Statements of Operations for the year ended 31 December 2022 was derived from the:

- Newmont Historical Statements of Operations for the year ended 31 December 2022 as outlined in section 6.15;
- Newcrest Historical Statements of Operations for the year ended 30 June 2022 as outlined in section 5.8 adjusted to exclude the financial performance for the six months from 1 July 2021 to 31 December 2021 and include the financial performance for the six months from 1 July 2022 to 31 December 2022 based on the information in the Newcrest half year financial reports for the six months ended 31 December 2021 and 31 December 2022 respectively;
- Newcrest Historical Statements of Operations for the year ended 31 December 2022 as derived above further adjusted for reclassifications and US GAAP conversion and accounting policy adjustments, as detailed in Notes 2 and 3 of section 7.7(e); and
- adjusted for the effects of pro forma adjustments described in Note 4 Transaction Accounting Adjustments of section 7.7(e).

The Merged Group Pro Forma Historical Financial Information as at and for the six months ended 30 June 2023 has been derived from the:

- Newmont Historical Balance Sheet as at 30 June 2023 and the Newmont Historical Statements of Operations for the six months ended 30 June 2023 as outlined in section 6.15;
- Newcrest Historical Balance Sheet as at 30 June 2023 and the Newcrest Historical Statements of Operations for the year ended 30 June 2023 as outlined in section 5.8 and for the purposes of the Merged Group Pro Forma Historical Statements of Operations adjusted to exclude the financial performance for the six months from 1 July 2022 to 31 December 2022 based on the information in Newcrest's half year financial report for the six months ended 31 December 2022;
- Newcrest Historical Balance Sheet as at 30 June 2023 and the Newcrest Historical Statements of Operations for the six months ended 30 June 2023 as derived above, further adjusted for reclassifications and US GAAP conversion and accounting policy adjustments, as detailed in Notes 2 and 3 of section 7.7(e); and
- adjusted for the effects of proforma adjustments described in Note 4 Transaction Accounting Adjustments of section 7.7(e).

7. Profile of the Merged Group

7.7 Pro forma historical financial information of the Merged Group *continued*

Implementation of the Scheme remains subject to the satisfaction of various Conditions Precedent, including Newcrest Shareholder approval, Court, regulatory and other approvals. Newmont notes that the Scheme has not been implemented, and may never be implemented, including due to reasons outside of Newmont's control.

No pro forma historical cash flows for the Merged Group have been presented on the basis of consistency with the Newmont Proxy Statement.

The Merged Group Pro Forma Historical Financial Information is presented for informational purposes only and is not intended to present or be indicative of what the results from operations or financial position would have been had the events actually occurred on the dates indicated, nor is it meant to be indicative of future results from operations or financial position for any future period or as of any future date. The Merged Group Pro Forma Historical Financial Information does not give effect to the potential impact of current financial conditions, or any anticipated revenue enhancements, cost savings or operating synergies that may result from the implementation of the Scheme and the integration of the two businesses.

The pro forma adjustments are based upon currently available information and certain assumptions that Newmont believes are reasonable. Assumptions underlying the pro forma adjustments are described in the accompanying notes, which should be read in conjunction with the Merged Group Pro Forma Historical Financial Information.

The actual adjustments to the Newmont Group's financial statements will depend upon a number of factors and additional information that will be available on or after the implementation of the Scheme. Accordingly, the actual adjustments that will appear in the Newmont Group's financial statements will differ from these pro forma adjustments, and those differences may be material.

The Newmont Group conducted an initial review of the Newcrest financial statements, which comply with IFRS, and the accounting policies of Newcrest to determine material differences in accounting policies and financial statement presentation between Newmont and Newcrest that may require alignment or reclassification to conform to Newmont's accounting policies and financial statement presentations. The Newcrest Historical Financial Information has also been adjusted, in accordance with the SEC's Rule 11-02 of Regulation S-X, for differences between IFRS and US GAAP. The assessment of differences between IFRS and US GAAP is based on Newmont management's best estimates which remain subject to change as additional information becomes available.

Newmont prepares its financial statements on the basis of a fiscal year ended 31 December and its presentation currency is USD. The financial statements of Newcrest Group have historically been prepared on the basis of a fiscal year ended 30 June and Newcrest's presentation currency is USD. The Merged Group Pro Forma Historical Financial Information is presented in USD and, unless otherwise noted, rounded to the nearest USD million.

Due to its nature, the Merged Group Pro Forma Historical Financial Information does not represent the Merged Group's actual or prospective financial position and financial performance.

The Merged Group Pro Forma Historical Financial Information contained in section 7.7 is presented in an abbreviated form as it does not include all the disclosures, statements or comparative information that are required by:

- US GAAP applicable to full financial statements or to financial statements prepared in accordance with the applicable rules and regulations of the SEC; and
- IFRS applicable to full financial statements or financial statements prepared in accordance with the Corporations Act.

The Merged Group Pro Forma Historical Financial Information contained in sections 7.7(c) and 7.7(d) is as follows:

- Merged Group Pro Forma Historical Statements of Operations for the six months ended 30 June 2023 and the year ended 31 December 2022 (table 7.7.1).
- Merged Group Pro Forma Historical Balance Sheet as at 30 June 2023 (table 7.7.4).

Sections 7.7(c) and 7.7(d) should be read in conjunction with the accompanying notes in section 7.7(e) "Notes to the Merged Group Pro Forma Historical Financial Information" which is comprised of:

- Note 1 – Overview of Notes.
- Note 2 – Reclassification adjustments to conform the presentation of Newcrest Historical Statements of Operations and Newcrest Historical Balance Sheet presentation to that of Newmont.
- Note 3 – IFRS to US GAAP and Accounting Policy Alignment Adjustments.
- Note 4 – Transaction Accounting Adjustments.
- Note 5 – Acquisition Method of Accounting.
- These notes are cross referenced on the tables presented in sections 7.7(c) and 7.7(d).



7.7 Pro forma historical financial information of the Merged Group continued

c) Merged Group Pro Forma Historical Statements of Operations

The following table presents the Merged Group Pro Forma Historical Statements of Operations for the six months ended 30 June 2023 and the year ended 31 December 2022. Refer to tables 7.7.2 and 7.7.3 of section 7.7(c) for the reconciliation.

Table 7.7.1: Merged Group Pro Forma Historical Statements of Operations for the six months ended 30 June 2023 and the year ended 31 December 2022

	Six months ended 30 June 2023 \$ millions	Year ended 31 December 2022 \$ millions
Sales	7,718	16,418
<i>Costs and expenses:</i>		
Costs applicable to sales	4,231	8,755
Depreciation and amortisation	1,316	2,966
Reclamation and remediation	140	934
Exploration	160	328
Advanced projects, research and development	81	233
General and administrative	211	398
Impairment charges	—	1,320
Other expense, net	78	686
	6,217	15,620
<i>Other income (expense):</i>		
Other income (loss), net	198	182
Interest expense, net of capitalised interest	(211)	(400)
	(13)	(218)
Income (loss) before income and mining tax and other items	1,488	580
Income and mining tax benefit (expense)	(553)	(781)
Equity income (loss) of affiliates	49	106
Net income (loss) from continuing operations ¹	984	(95)
Net loss (income) attributable to noncontrolling interests	(12)	(60)
Net income (loss) from continuing operations attributable to Newmont stockholders	972	(155)

Note:

- Newmont had Net income (loss) from discontinued operations of \$14 million for the six months ended 30 June 2023 and \$30 million for the year ended 31 December 2022. These have been excluded from the Merged Group Pro Forma Historical Statements of Operations given these are not reflective of the business going forward.

7. Profile of the Merged Group

7.7 Pro forma historical financial information of the Merged Group *continued*

The following table reconciles the Merged Group Pro Forma Historical Statements of Operations with Newmont and Newcrest historical consolidated statements of operations for the six months ended 30 June 2023.

Table 7.7.2: Reconciliation of the Merged Group Pro Forma Historical Statements of Operations for the six months ended 30 June 2023

\$ millions	Historical	Reclassified Historical ¹	IFRS to US GAAP and Accounting Policy Adjustments (Note 3)		Transaction Accounting Adjustments (Note 4)		Pro Forma Historical Merged Group
	Newmont	Newcrest (Note 2)		(Note)		(Note)	
Sales	5,362	2,387	(31)	3(a)	—		7,718
<i>Costs and expenses:</i>							
Costs applicable to sales ²	3,025	1,226	56	3(a)(c)(g)(i)(j)	(76)	4(b)	4,231
Depreciation and amortisation	947	433	(88)	3(b)(c)(d)(g)(j)	24	4(b)(c)(e)	1,316
Reclamation and remediation	132	8	—	—	—	4(e)	140
Exploration	114	38	8	3(e)	—		160
Advanced projects, research and development	79	2	—		—		81
General and administrative	145	66	—		—		211
Other expense, net	49	22	7	3(a)	—		78
	4,491	1,795	(17)		(52)		6,217
<i>Other income (expense):</i>							
Other income (loss), net	82	114	2	3(f)(h)	—		198
Interest expense, net of capitalised interest	(114)	(63)	2	3(j)	(36)	4(f)	(211)
	(32)	51	4		(36)		(13)
Income (loss) before income and mining tax and other items	839	643	(10)		16		1,488
Income and mining tax benefit (expense)	(376)	(177)	5	3(b)(e)(g)(i)	(5)	4(g)	(553)
Equity income (loss) of affiliates	41	19	4	3(f)	(15)	4(d)	49
Net income (loss) from continuing operations	504	485	(1)		(4)		984
Net loss (income) from continuing operations attributable to noncontrolling interests	(12)	—	—		—		(12)
Net income (loss) from continuing operations attributable to Newmont stockholders	492	485	(1)		(4)		972

Notes:

1. Refer to Table 7.7.7. Note that the signage for Costs and expenses has changed to align with the Newmont presentation.
2. Excludes *Depreciation and amortisation* and *Reclamation and remediation*.

In the above table, the figures reported in the:

- ‘Reclassified Historical Newcrest’ column contains certain financial information line items which have been aligned to Newmont’s financial period (refer to table 7.7.5 in section 7.7(e)) and reclassified to align with Newmont’s presentation (refer to Note 2 in section 7.7(e) for details).
- ‘IFRS to US GAAP and Accounting Policy Adjustments’ column relate to US GAAP adjustments and accounting policy adjustments as detailed in Note 3 in section 7.7(e).
- ‘Transaction Accounting Adjustments’ column relate to certain preliminary purchase price accounting and other pro forma adjustments. Refer to Note 4 in section 7.7(e) for details.

7.7 Pro forma historical financial information of the Merged Group *continued***Table 7.7.3: Reconciliation of the Merged Group Pro Forma Historical Statements of Operations for the year ended 31 December 2022**

The following table reconciles the Merged Group Pro Forma Historical Statements of Operations with Newmont and Newcrest historical statements of operations for the year ended 31 December 2022.

\$ millions	Historical	Reclassified Historical ¹	IFRS to US GAAP and Accounting Policy Adjustments (Note 3)	Transaction Accounting Adjustments (Note 4)	Pro Forma Historical Merged Group ²		
	Newmont	Newcrest (Note 2)	(Note)	(Note)	(Note)		
Sales	11,915	4,613	(110)	3(a)	—	16,418	
<i>Costs and expenses:</i>							
Costs applicable to sales ³	6,468	2,318	137	3(a)(c)(g)(i)(j)	(168)	4(b)	8,755
Depreciation and amortisation	2,185	916	(197)	3(b)(c)(d)(g)(j)	62	4(b)(c)(e)	2,966
Reclamation and remediation	921	13	—	—	—	4(e)	934
Exploration	231	80	17	3(e)	—	—	328
Advanced projects, research and development	229	4	—	—	—	—	233
General and administrative	276	122	—	—	—	—	398
Impairment charges	1,320	—	—	—	—	—	1,320
Other expense, net	82	121	(74)	3(a)	557	4(a)	686
	11,712	3,574	(117)		451		15,620
<i>Other income (expense):</i>							
Other income (loss), net ⁴	(27)	272	(63)	3(f)(h)	—	—	182
Interest expense, net of capitalised interest	(227)	(105)	3	3(j)	(71)	4(f)	(400)
	(254)	167	(60)		(71)		(218)
Income (loss) before income and mining tax and other items	(51)	1,206	(53)		(522)		580
Income and mining tax benefit (expense)	(455)	(363)	1	3(b)(e)(g)(i)	36	4(g)	(781)
Equity income (loss) of affiliates	107	24	5	3(f)	(30)	4(d)	106
Net income (loss) from continuing operations	(399)	867	(47)	—	(516)	—	(95)
Net loss (income) from continuing operations attributable to noncontrolling interests	(60)	—	—	—	—	—	(60)
Net income (loss) from continuing operations attributable to Newmont stockholders	(459)	867	(47)		(516)		(155)

Notes:

1. Refer to Table 7.7.8. Note that the signage for *Costs and expenses* has changed to align with the Newmont presentation.
2. Newcrest acquired Pretium Resources Inc. on 25 February 2022. Pretium Resources Inc. has been consolidated into Newcrest Historical Financial Information from the date of acquisition. This approach is consistent with the treatment in the Newmont Proxy Statement.
3. Excludes *Depreciation and amortisation* and *Reclamation and remediation*.
4. *Other income (loss), net* of \$(27) million for Newmont includes \$35 million of *Gain on asset and investment sales, net*.

In the above table, the figures reported in the:

- ‘Reclassified Historical Newcrest’ column contains certain financial information line items which have been aligned to Newmont’s financial period (refer to table 7.7.6) and reclassified to align with Newmont’s presentation (refer to Note 2 in section 7.7(e) for details).
- ‘IFRS to US GAAP and Accounting Policy Adjustments’ column relate to US GAAP adjustments and accounting policy adjustments as detailed in Note 3 in section 7.7(e).
- ‘Transaction Accounting Adjustments’ column relate to certain preliminary purchase price accounting and other pro forma adjustments. Refer to Note 4 in section 7.7(e) for details.

7. Profile of the Merged Group

7.7 Pro forma historical financial information of the Merged Group continued

d) Merged Group Pro Forma Historical Balance Sheet

Table 7.7.4: Merged Group Pro Forma Historical Balance Sheet as at 30 June 2023

\$ millions	Historical	Reclassified Historical	GAAP and Accounting Policy Adjustments	(Note)	Transaction Accounting Adjustments	(Note)	Pro Forma Historical Merged Group
	Newmont	Newcrest (Note 2)	(Note 3)		(Note 4)		
Assets							
Cash and cash equivalents	2,829	586	—		—		3,415
Time deposits and other investments	409	—	—		—		409
Trade receivables	185	143	—		—		328
Inventories	1,111	536	8	3(g)	30	4(b)	1,685
Stockpiles and ore on leach pads	858	79	18	3(g)	66	4(b)	1,021
Other current assets	742	309	(7)	3(h)	—		1,044
Current assets	6,134	1,653	19		96		7,902
Property, plant and mine development, net	24,284	13,028	62	3(b)(c)(e)(j)	1,928	4(c)	39,302
Investments	3,172	483	(3)	3(f)	570	4(d)	4,222
Stockpiles and ore on leach pads	1,737	1,116	655	3(g)	(1,644)	4(b)	1,864
Deferred income tax assets	166	50	—		—		216
Goodwill	1,971	686	—		1,848	4(i)	4,505
Other non-current assets	669	505	50	3(h)(j)	8		1,232
Total assets	38,133	17,521	783		2,806		59,243
Liabilities							
Accounts payable	565	679	—		—		1,244
Employee-related benefits	313	166	—		—		479
Income and mining taxes	155	37	—		—		192
Lease and other financing obligations	96	45	(32)	3(j)	—		109
Debt	—	—	—		1,282	4(f)	1,282
Other current liabilities	1,564	57	32	3(j)	550	4(a)(e)	2,203
Current liabilities	2,693	984	—		1,832		5,509
Debt	5,574	1,935	—		(486)	4(f)	7,023
Lease and other financing obligations	441	65	(57)	3(j)	—		449
Reclamation and remediation liabilities	6,604	499	—		(118)	4(e)	6,985
Deferred income tax liabilities	1,795	2,314	174	3(b)(c)(e)(g)(h)(i)	(261)	4(a)(g)	4,022
Employee-related benefits	399	12	205	3(i)	—		616
Silver streaming agreement	786	—	—		—		786
Other non-current liabilities	426	—	57	3(j)	—		483
Total liabilities	18,718	5,809	379		967		25,873
Equity							
Common stock	1,281	—	—		572	4(h)	1,853
Treasury stock	(261)	—	—		—		(261)
Additional paid-in capital	17,407	13,931	—		(38)	4(h)	31,300
Accumulated other comprehensive income (loss)	13	(779)	8	3(c)(e)(f)	771	4(h)	13
Retained earnings (accumulated deficit)	785	(1,440)	396		534	4(h)	275
Newmont stockholders' equity	19,225	11,712	404		1,839		33,180
Noncontrolling interests	190	—	—		—		190
Total equity	19,415	11,712	404		1,839		33,370
Total liabilities and equity	38,133	17,521	783		2,806		59,243



7.7 Pro forma historical financial information of the Merged Group continued

In Table 7.7.4 on previous page, the figures reported in the:

- ‘Reclassified Historical Newcrest’ column contains certain financial information line items which have been reclassified to align with Newmont’s presentation (refer to Note 2 in section 7.7(e) for details).
- ‘IFRS to US GAAP and Accounting Policy Adjustments’ column relate to US GAAP adjustments and accounting policy adjustments as detailed in Note 3 in section 7.7(e).
- ‘Transaction Accounting Adjustments’ column relate to certain preliminary purchase price accounting and other pro forma adjustments. Refer to Note 4 in section 7.7(e) for details.

e) Notes to the Merged Group Pro Forma Historical Financial Information

Note 1 – Overview of Notes

Newcrest’s historical financial information has been adjusted to align the financial reporting period to Newmont Group’s 31 December year end.

The Newcrest Historical Financial Information included in section 5.8 of this Scheme Booklet has been prepared in accordance with the recognition and measurement principles of AAS issued by the AASB, which are consistent with IFRS issued by the IASB. Certain differences exist between IFRS and US GAAP, which are material to understanding the Merged Group Pro Forma Historical Financial Information included in this Scheme Booklet.

Newcrest’s historical financial information has been adjusted, in accordance with the SEC’s Rule 11-02 of Regulation S-X, for differences between IFRS and US GAAP. These adjustments are based on a preliminary analysis by Newmont’s management. The principal differences between IFRS and US GAAP which are material to the preparation of the Merged Group Pro Forma Historical Financial Information and required reclassification or adjustment are described below. This summary does not include all differences that exist between IFRS and US GAAP and is not intended to provide a comprehensive listing of all such differences specifically related to Newcrest, Newmont, or the industry in which Newcrest and Newmont operate. When Newmont’s management completes a final review of Newcrest’s accounting policies, additional differences may be identified that, when conformed, could have a material impact on the Merged Group Pro Forma Historical Financial Information.

The differences described below in Note 2 and Note 3 reflect only those differences in accounting policies in force at the time of the preparation of the Newcrest Historical Financial Information and the Newmont Historical Financial Information included in this Scheme Booklet. There has been no attempt to identify future differences between IFRS and US GAAP as the result of prescribed changes in accounting standards, transactions or events that may occur in the future.

Adjustments have also been made to the Merged Group Pro Forma Historical Financial Information to reflect certain preliminary purchase price accounting and other pro forma adjustments. These adjustments are described below in Note 4 Transaction Accounting Adjustments.

7. Profile of the Merged Group

7.7 Pro forma historical financial information of the Merged Group *continued*

Table 7.7.5: Reconciliation of Newcrest Historical Statements of Operations for the six months ended 30 June 2023

The following table provides a reconciliation of the Newcrest Historical Statements of Operations for the six months ended 30 June 2023.

	(A)	(B)	(A)-(B)
	Annual Report for year ended 30 June 2023 \$ millions	Half-year Financial Report for six months ended 31 December 2022 \$ millions	Historical for six months ended 30 June 2023 \$ millions
Revenue	4,508	2,121	2,387
Cost of sales	(3,282)	(1,632)	(1,650)
Gross profit	1,226	489	737
Exploration expenses	(76)	(38)	(38)
Corporate administration expenses	(138)	(63)	(75)
Other income/(expenses)	141	72	69
Share of profit/(loss) of associates	19	—	19
Profit before interest and income tax	1,172	460	712
Finance income	41	20	21
Finance costs	(137)	(66)	(71)
Net finance costs	(96)	(46)	(50)
Profit before income tax	1,076	414	662
Income tax expense	(298)	(121)	(177)
Profit after income tax	778	293	485

In the table above, 'Historical for six months ended 30 June 2023' column is the historical consolidated statements of operations for the Newcrest Group, calculated as the difference between:

- (A) Newcrest's historical consolidated statements of operations for the year ended 30 June 2023, which has been derived from Newcrest's Annual Report for the year ended 30 June 2023; and
- (B) Newcrest's historical consolidated statements of operations for the six months ended 31 December 2022, which has been derived from the Half-year Financial Report for the six months ended 31 December 2022.

7.7 Pro forma historical financial information of the Merged Group *continued***Table 7.7.6: Reconciliation of Newcrest Historical Statements of Operations for the year ended 31 December 2022**

The following table provides a reconciliation of the Newcrest Historical Statements of Operations for the year ended 31 December 2022.

	(A)	(B)	(C)	(A)-(B)+(C)
	Annual Report for year ended 30 June 2022 \$ millions	Half-year Financial Report for six months ended 31 December 2021 \$ millions	Half-year Financial Report for six months ended 31 December 2022 \$ millions	Historical for six months ended 30 June 2022 \$ millions
Revenue	4,207	1,715	2,121	4,613
Cost of sales	(2,853)	(1,269)	(1,632)	(3,216)
Gross profit	1,354	446	489	1,397
Exploration expenses	(76)	(34)	(38)	(80)
Corporate administration expenses	(138)	(61)	(63)	(140)
Other income/(expenses)	119	76	72	115
Share of profit/(loss) of associates	45	21	—	24
Profit before interest and income tax	1,304	448	460	1,316
Finance income	25	13	20	32
Finance costs	(100)	(48)	(66)	(118)
Net finance costs	(75)	(35)	(46)	(86)
Profit before income tax	1,229	413	414	1,230
Income tax expense	(357)	(115)	(121)	(363)
Profit after income tax	872	298	293	867

In the table above, 'Historical for the year ended 31 December 2022' column is the historical consolidated statements of operations for the Newcrest Group, calculated as the sum of:

- (A) Newcrest's historical consolidated statements of operations for the year ended 30 June 2022; less
- (B) Newcrest's historical consolidated statements of operations for the six months ended 31 December 2021; plus
- (C) Newcrest's historical consolidated statements of operations for the six months ended 31 December 2022.

7. Profile of the Merged Group

7.7 Pro forma historical financial information of the Merged Group *continued*

Note 2 – Reclassification adjustments to conform the presentation of the Newcrest Historical Statements of Operations and Newcrest Historical Balance Sheet presentation to that of the Newmont Historical Statements of Operations and Newmont Historical Balance Sheet respectively

Statements of Operations reclassifications

The reclassification adjustments to conform the Newcrest Group's historical consolidated statements of operations presentation to that of the Newmont Group's statements of operations have no impact on the profit after income tax for the six months ended 30 June 2023 and the year ended 31 December 2022 and are summarised in the tables below.

Table 7.7.7: Reconciliation of Newcrest Historical Statements of Operations for the six months ended 30 June 2023 for Reclassification Adjustments

Newcrest Financial Statement Line	Newcrest Historical Amount \$ millions	Reclassifications \$ millions	Newcrest Historical Reclassified \$ millions	Newmont Financial Statement Line
Revenue	2,387	—	2,387	Sales
Cost of sales	(1,650)	424 ¹	(1,226)	Costs applicable to sales
	—	(433) ¹	(433)	Depreciation and amortisation
	—	(8) ²	(8)	Reclamation and remediation
Exploration expenses	(38)	—	(38)	Exploration
	—	(2) ³	(2)	Advanced projects, research and development
Corporate administration expenses	(75)	9 ¹	(66)	General and administrative
Other income/(expenses)	69	(91) ^{3,4}	(22)	Other expense, net
Share of profit/(loss) of associates	19	(19) ⁵	—	
Finance income	21	93 ⁴	114	Other income (loss), net
Finance costs	(71)	8 ²	(63)	Interest expense, net of capitalised
Income tax expense	(177)	—	(177)	Income and mining tax benefit (expense)
	—	19 ⁵	19	Equity income (loss) of affiliates
Profit after income tax	485	—	485	Net income from continuing operations

Notes:

1. Represents a reclassification of Newcrest's depreciation and amortisation, historically included in *Cost of sales* and *Corporate administration expenses*, to *Depreciation and amortisation* at Newmont.
2. Represents a reclassification of Newcrest's accretion expense, historically included in *Finance costs*, to *Reclamation and remediation* at Newmont.
3. Represents a reclassification of Newcrest's exploration, evaluation, and research and development expenses, historically included in *Other income/(expenses)*, to *Advanced projects, research and development* at Newmont.
4. Represents a reclassification of Newcrest's other income, historically included in *Other income/(expenses)*, to *Other income (loss), net* at Newmont.
5. Represents a reclassification of Newcrest's share of earnings from equity method investments, historically included in *Share of profit/(loss) of associates*, to *Equity income (loss) of affiliates* at Newmont.

Table 7.7.8: Reconciliation of Newcrest Historical Statements of Operations for the year ended 31 December 2022 for Reclassification Adjustments

Newcrest Financial Statement Line	Newcrest Historical Amount \$ millions	Reclassifications \$ millions	Newcrest Historical Reclassified \$ millions	Newmont Financial Statement Line
Revenue	4,613	—	4,613	Sales
Cost of sales	(3,216)	898 ¹	(2,318)	Costs applicable to sales
	—	(916) ¹	(916)	Depreciation and amortisation
	—	(13) ²	(13)	Reclamation and remediation
Exploration expenses	(80)	—	(80)	Exploration
	—	(4) ³	(4)	Advanced projects, research and development
Corporate administration expenses	(140)	18 ¹	(122)	General and administrative
Other income/(expenses)	115	(236) ^{3,4}	(121)	Other expense, net
Share of profit/(loss) of associates	24	(24) ⁵	—	
Finance income	32	240 ⁴	272	Other income (loss), net
Finance costs	(118)	13 ²	(105)	Interest expense, net of capitalised interest
Income tax expense	(363)	—	(363)	Income and mining tax benefit (expense)
	—	24 ⁵	24	Equity income (loss) of affiliates
Profit after income tax	867	—	867	Net income from continuing operations

Notes:

1. Represents a reclassification of Newcrest's depreciation and amortisation, historically included in *Cost of sales* and *Corporate administration expenses*, to *Depreciation and amortisation* at Newmont.
2. Represents a reclassification of Newcrest's accretion expense, historically included in *Finance costs*, to *Reclamation and remediation* at Newmont.
3. Represents a reclassification of Newcrest's exploration, evaluation, and research and development expenses, historically included in *Other income/(expenses)*, to *Advanced projects, research and development* at Newmont.
4. Represents a reclassification of Newcrest's other income, historically included in *Other income/(expenses)*, to *Other income (loss), net* at Newmont.
5. Represents a reclassification of Newcrest's share of earnings from equity method investments, historically included in *Share of profit/(loss) of associates*, to *Equity income (loss) of affiliates* at Newmont.

7.7 Pro forma historical financial information of the Merged Group continued

Balance sheet reclassifications

The reclassification adjustments to conform the presentation of the Newcrest Historical Balance Sheet presentation to that of the Newmont Group's as at 30 June 2023 has no material impact on net assets as at 30 June 2023 and are summarised below.

Table 7.7.9: Reconciliation of Newcrest Historical Balance Sheet for Reclassification Adjustments as at 30 June 2023

Newcrest Financial Statement Line	Newcrest Historical Amount \$ millions	Reclassifications \$ millions	Newcrest Historical Reclassified \$ millions	Newmont Financial Statement Line
Assets				Assets
Current: Cash and cash equivalents	586	—	586	Current: Cash and cash equivalents
Current: Trade and other receivables	254	(111) ¹	143	Current: Trade receivables
Current: Inventories	615	(79) ²	536	Current: Inventories
	—	79 ²	79	Current: Stockpiles and ore on leach pads
Current: Other financial assets	60	—	60	Current: Other current assets
Current: Current tax assets	58	—	58	Current: Other current assets
Current: Other assets	80	111 ¹	191	Current: Other current assets
Trade and other receivables	109	—	109	Other non-current assets
Inventories	1,116	—	1,116	Stockpiles and ore on leach pads
Other financial assets	351	—	351	Other non-current assets
Property, plant and equipment	12,996	32 ³	13,028	Property, plant and mine development, net
Goodwill	686	—	686	Goodwill
Other intangible assets	32	(32) ³	—	
Deferred tax assets	50	—	50	Deferred income tax assets
Investment in associates	483	—	483	Investments
Other assets	45	—	45	Other non-current assets
Total assets	17,521	—	17,521	Total assets
Liabilities				Liabilities
Current: Trade and other payables	693	(14) ⁴	679	Current: Accounts payable
	—	166 ⁴	166	Current: Employee-related benefits
Current: Lease liabilities	45	—	45	Current: Lease and other financing obligations
Current borrowings	—	—	—	Current: Debt
Current: Provisions	176	(152) ⁴	24	Current: Other current liabilities
Current: Current tax liability	37	—	37	Current: Income and mining taxes
Current: Other financial liabilities	33	—	33	Current: Other current liabilities
Borrowings	1,935	—	1,935	Debt
Lease liabilities	65	—	65	Lease and other financing obligations
Provisions	511	(12) ⁵	499	Reclamation and remediation liabilities
Deferred tax liabilities	2,314	—	2,314	Deferred income tax liabilities
	—	12 ⁵	12	Employee-related benefits
Other financial liabilities	—	—	—	Other non-current liabilities
Total liabilities	5,809	—	5,809	Total liabilities
Equity				Equity
Issued capital	13,764	(13,764) ⁶	—	Common stock
	—	13,931 ^{6,7}	13,931	Additional paid-in capital
Accumulated losses	(1,440)	—	(1,440)	Retained earnings (accumulated deficit)
Reserves	(612)	(167) ⁷	(779)	Accumulated other comprehensive income (loss)
Total equity	11,712	—	11,712	Total equity

Notes:

1. Represents a reclassification of Newcrest's other accounts receivable, historically included in *Trade and other receivables*, to *Other current assets* at Newmont.
2. Represents a reclassification of Newcrest's stockpiles, historically included in *Inventories*, to *Stockpiles and ore on leach pads* at Newmont.
3. Represents a reclassification of Newcrest's software, historically included in *Other intangible assets*, to *Property, plant and mine development, net* at Newmont.
4. Represents a reclassification of Newcrest's employee-related benefits, historically included in *Trade and other payables* and *Provisions*, to current *Employee-related benefits* at Newmont.
5. Represents a reclassification of Newcrest's non-current employee-related benefits, historically included in *Provisions*, to *Employee-related benefits* at Newmont.
6. Represents a reclassification of Newcrest's ordinary shares, which have no par value and were historically included in *Issued capital*, to *Additional paid-in capital* at Newmont.
7. Represents a reclassification of Newcrest's share-based payment reserve, historically included in *Reserves*, to *Additional paid-in capital* at Newmont.

7. Profile of the Merged Group

7.7 Pro forma historical financial information of the Merged Group *continued*

Note 3 – IFRS to US GAAP and Accounting Policy Alignment Adjustments

IFRS differs in certain material respects from US GAAP. The following material adjustments have been made to reflect Newcrest's historical consolidated statements of operations for the six months ended 30 June 2023 and the year ended 31 December 2022 and Newcrest Historical Balance Sheet as at 30 June 2023 on a US GAAP basis for the purposes of the Merged Group Pro Forma Historical Financial Information. In addition, material adjustments have also been made to align Newcrest's significant accounting policies under IFRS to Newmont's significant accounting policies under US GAAP when there is no specific difference between IFRS and US GAAP.

a) *By-product versus co-product revenue accounting*

Under Newmont's accounting policy, a metal is considered a by-product when sales represent less than 10 percent and up to 20 percent of the total sales from all metals on a life of mine basis and revenue from by-product metal sales is recognised as a reduction to *Cost applicable to sales*. Additionally, mark-to-market impacts related to provisionally priced by-product sales are recognised in *Cost applicable to sales*, while mark-to-market impacts related to provisionally priced co-product sales are recognised in *Sales*.

Newcrest's accounting policy is to recognise proceeds from sales of all metals in sales and all mark-to-market impacts of provisionally priced sales within *Other expense, net*.

The following table reflects the impact of reclassifying sales for certain metals that are considered by-products metals by Newmont, and the reclassification of mark-to-market impacts of provisionally priced co-product sales from *Other expense, net to Sales*:

	For the six months ended 30 June 2023 \$ millions	For the year ended 31 December 2022 \$ millions
Statements of Operations		
Decrease to sales	(31)	(110)
Decrease to cost applicable to sales	(38)	(36)
Increase (decrease) to other expense, net	7	(74)

b) *Impairment charges*

Under both US GAAP and IFRS, long-lived assets are tested for impairment when events or changes in circumstances indicate that the carrying amounts may be impaired. Under US GAAP, an asset group is first tested for recoverability by determining if the carrying amount exceeds the expected future cash flows from the asset group on an undiscounted basis. If the asset group is determined not to be recoverable on an undiscounted basis, an impairment expense is recorded for the excess of the asset group's carrying amount over its fair value. Further, future reversal of a previously recognised impairment loss is prohibited.

Under IFRS, when an impairment indicator is determined to exist, an impairment expense is recorded for the excess of a cash generating unit's carrying amount over the greater of its fair value less costs of disposal and its value in use. Impairment expense previously recorded is reversible in subsequent periods under certain conditions.

The following table reflects the reversal of impairment expense recognised by Newcrest under IFRS, when assessed under US GAAP on an undiscounted cash flow basis, after adjusting the carrying value of the property, plant and mine development for

- i) incremental depreciation expense which would have been recorded had the asset not been impaired,
- ii) the exclusion of resources from recoverable ounces, utilised in calculating depreciation expense, to align with Newmont's accounting policy, and
- iii) reversing mine development and stripping costs capitalised by Newcrest, as outlined in Note 3(c) in section 7.7(e):

	As at 30 June 2023 \$ millions	For the six months ended 30 June 2023 \$ millions	For the year ended 31 December 2022 \$ millions
Balance Sheet			
Increase to property, plant and mine development, net	973		
Increase to deferred income tax liabilities	292		
Statements of Operations			
Increase to depreciation and amortisation		15	32
Increase to income and mining tax benefit (expense)		5	10

7.7 Pro forma historical financial information of the Merged Group *continued*

c) Mine development and stripping costs

Under US GAAP, Newmont capitalises mine development costs and stripping costs to access the main ore body after mineralisation is classified as proven and probable reserves, and before the production phase of the mine. After the production phase of a mine is achieved, stripping costs are included as variable production costs of stockpiles and ore on leach pads.

Under IFRS, Newcrest capitalises mine development costs, including stripping costs to remove overburden and waste to access the main ore body, and in addition, Newcrest continues to capitalise stripping costs after the production phase of a mine if certain conditions are met and when the strip ratio exceeds the estimated life of mine strip ratio of the open pit mine. The capitalised stripping costs are depreciated over the expected useful life of the identified component of the ore body that is made more accessible by the activity, on a units-of-production basis.

The following table reflects the reversal of mine development and stripping costs capitalised by Newcrest before mineralisation is classified as proven and probable reserves and after the production phase of a mine is achieved, net of depreciation and amortisation. These costs are included as variable production costs, as further outlined in Note 3(g) in section 7.7(e):

	As at 30 June 2023 \$ millions	For the six months ended 30 June 2023 \$ millions	For the year ended 31 December 2022 \$ millions
Balance Sheet			
Decrease to property, plant and mine development, net	(364)		
Decrease to deferred income tax liabilities	(116)		
Decrease to accumulated other comprehensive income (loss)	(1)		
Statements of Operations			
Increase to cost applicable to sales		98	229
Decrease to depreciation and amortisation		(98)	(235)

d) Depreciation and amortisation

Under US GAAP, Newmont's accounting policy is to amortise certain mine development costs using the units-of-production method based on estimated recoverable ounces or pounds in proven and probable reserves. Under IFRS, Newcrest includes estimated recoverable ounces contained in proven and probable reserves and, at certain operations, a portion of resources that are considered to be highly probable of being economically recovered.

The impact of excluding resources from recoverable ounces in units-of-production method based depreciation expense calculations is included in certain adjustments and is noted where applicable.

e) Exploration and evaluation costs

Under US GAAP, Newmont incurs exploration and evaluation costs during exploration and development phases. Costs incurred during the exploration phase and before mineralisation is classified as proven and probable reserves are expensed. Costs incurred during the development phase and after mineralisation is classified as proven and probable reserves are capitalised.

Under IFRS, an entity is able to make an accounting policy election on whether to expense or capitalise exploration, evaluation and deferred feasibility costs. Newcrest capitalises exploration, evaluation and deferred feasibility costs if either such costs are expected to be recouped, significant exploration activity is ongoing with a reasonable assessment of the existence of economically recoverable reserves, or when expenditures are incurred to enable a development decision.

The following table reflects the impact of expensing a portion of the exploration, evaluation and deferred feasibility costs capitalised by Newcrest under IFRS as those costs were incurred before declaration of proven and probable reserves as required for capitalisation under US GAAP:

	As at 30 June 2023 \$ millions	For the six months ended 30 June 2023 \$ millions	For the year ended 31 December 2022 \$ millions
Balance Sheet			
Decrease to property, plant and mine development, net	(464)		
Decrease to deferred income tax liabilities	(134)		
Increase to accumulated other comprehensive income (loss)	3		
Statements of Operations			
Increase to exploration		8	17
Increase to income and mining tax benefit (expense)		3	6

7. Profile of the Merged Group

7.7 Pro forma historical financial information of the Merged Group continued

f) Equity method investments

Under US GAAP, the equity method is applied if an investor has the ability to exercise significant influence over the operating and financial policies of an investee. A common stock investment in a corporate entity that provides an investor with ownership of 20% or more of the investee's voting stock, but with less than a controlling financial interest, leads to a presumption that the investor has the ability to exercise significant influence over the investee. Conversely, an investment of less than 20% of the voting stock of an investee leads to a presumption that an investor does not have the ability to exercise significant influence unless such ability can be demonstrated. Newmont's accounting policy considers both ownership percentage and other factors impacting the ability to exercise significant influence, such as present voting rights related to board representation and other advisory arrangements, when assessing whether an investor has significant influence. The evaluation of significant influence is generally consistent under both IFRS and US GAAP, except US GAAP considers only present voting rights while IFRS also takes into consideration potential voting rights that are currently exercisable.

Certain investments held by Newcrest are below the presumed 20% ownership, have the current rights to board representation that are unfulfilled, and have separate advisory arrangements. Therefore, the presumption of significant influence is not met under US GAAP.

The following table reflects the impact of converting certain interests held by Newcrest from the equity method of accounting under IFRS to a marketable equity security under US GAAP as the percentage ownership is less than 20 percent:

	As at 30 June 2023 \$ millions	For the six months ended 30 June 2023 \$ millions	For the year ended 31 December 2022 \$ millions
Balance Sheet			
Decrease to investments	(3)		
Increase to accumulated other comprehensive income (loss)	6		
Statements of Operations			
Increase (decrease) to other income (loss), net		2	(61)
Increase to equity income (loss) of affiliates		4	5

g) Stockpiles and ore on leach pads

Under US GAAP, costs that are incurred in or benefit the production process are accumulated as stockpiles and ore on leach pads. Stockpiles and ore on leach pads are carried at the lower of average cost or net realisable value. Net realisable value represents the estimated future sales price of the product based on current and long-term metals prices, less the estimated costs to complete production and bring the product to sale. Costs are added to stockpiles and ore on leach pads based on current mining costs, including stripping costs incurred during the production phase of a mine (refer to Note 3(c) in section 7.7(e)), and applicable depreciation and amortisation relating to mining operations. Costs are removed from stockpiles and ore on leach pads based on the average cost per estimated recoverable ounces as material is processed.

Under IFRS, ore stockpiles are largely accounted for in the same manner with the exception of stripping costs during the production phase of a mine, which are capitalised when certain conditions are met. Under Newcrest's accounting policy, costs are added to stockpiles based on current mining costs incurred including applicable overheads and depreciation and amortisation on a unit of production basis for mining operations and removed on the basis of each stockpile's average cost per tonne as material is processed. Production stripping costs are capitalised separately for each component of the mine, which is defined as a specific volume of the ore body that is made accessible by the stripping activity and amortised on a unit of production basis.



7.7 Pro forma historical financial information of the Merged Group *continued*

The following table reflects the impact to the carrying value of ore stockpiles under US GAAP, including alignment to Newmont's accounting policies on inventory valuation methodology, and is comprised of:

- i) the reversal of stripping costs capitalised by Newcrest, as outlined in Note 3(c) in this section 7.7(e);
- ii) the reversal of previous impairment expense recognised by Newcrest, as outlined in Note 3(b) in this section 7.7(e);
- iii) the allocation of mining costs per ounce on the basis of recoverable ounces as compared to on a per tonne basis; and
- iv) alignment relating to the capitalisation of costs for ore stockpiles.

	As at 30 June 2023 \$ millions	For the six months ended 30 June 2023 \$ millions	For the year ended 31 December 2022 \$ millions
Balance Sheet			
Increase to inventories	8		
Increase to current stockpiles and ore on leach pads	18		
Increase to stockpiles and ore on leach pads ¹	655		
Increase to deferred income tax liabilities	204		
Statements of Operations			
Decrease to costs applicable to sales		(25)	(93)
Increase to depreciation and amortisation		11	35
Decrease to income and mining tax benefit (expense)		(4)	(17)

Note:

1. Comprised of \$188 million for reversal of stripping costs, \$74 million for reversal of previous impairment expense and \$411 million related to Newmont's valuation methodology.

h) Derivatives

Under US GAAP, the definition of a derivative requires the existence of a notional amount, a payment provision or both. In circumstances in which a notional amount is not determinable (e.g., when the quantification of such an amount is highly subjective and relatively unreliable) and no payment provision exists, the contract would not be accounted for as a derivative. Under IFRS, the definition of a derivative does not require the existence of a notional amount or payment provision.

The following table reflects the impact of the reversal of fair value associated with the derivative instruments determined not to meet the definition of a derivative under US GAAP:

	As at 30 June 2023 \$ millions	For the six months ended 30 June 2023 \$ millions	For the year ended 31 December 2022 \$ millions
Balance Sheet			
Decrease to other current assets	(7)		
Decrease to other non-current assets	(33)		
Decrease to deferred income tax liabilities	(8)		
Statements of Operations			
Decrease to other income (loss), net		—	(2)

7. Profile of the Merged Group

7.7 Pro forma historical financial information of the Merged Group *continued*

i) Employee-related benefits

Under US GAAP, an entity uses the service period approach to account for termination benefits when certain conditions are met. Benefits accumulate over time based on length of service. Under this approach, the benefit cost is accrued over an employee's service period.

Under IFRS, an entity recognises termination benefits as a liability and an expense only when an entity is demonstrably committed to the redundancies by having (i) a detailed plan for the terminations and (ii) when it can no longer withdraw the offer made in relation to termination benefits. This generally results in termination benefits being recognised when the closure date for a mine site has been announced and other recognition criteria have been met.

The following table reflects the accrual of employee severance for Newcrest and its consolidated Subsidiaries as well as the impact of revaluation of the accrual for the periods presented:

	As at 30 June 2023 \$ millions	For the six months ended 30 June 2023 \$ millions	For the year ended 31 December 2022 \$ millions
Balance Sheet			
Increase to employee-related benefits	205		
Decrease to deferred income tax liabilities	(64)		
Statements of Operations			
Increase to costs applicable to sales		3	5
Increase to income and mining tax benefit (expense)		1	2

j) Lease and other financing obligations

Under US GAAP, a lessee identifies a lease at inception of the agreement and classifies it as either a finance lease or an operating lease based on the application of five specific criteria. Under IFRS, similar to US GAAP, a lessee identifies a lease at inception of the agreement but does not distinguish between an operating lease and a finance lease. A single recognition and measurement model is applied to all leases under IFRS.

While the initial measurement and recognition of a lease is similar under US GAAP and IFRS, the subsequent measurement differs. Under US GAAP, a straight-line expense is recognised for an operating lease, as opposed to IFRS, which yields a higher expense in earlier years of the lease term.

The following table reflects the impact of reclassifying certain Newcrest leases as operating leases under US GAAP:

	As at 30 June 2023 \$ millions	For the six months ended 30 June 2023 \$ millions	For the year ended 31 December 2022 \$ millions
Balance Sheet			
Decrease to property, plant and mine development, net	(83)		
Increase to other non-current assets	83		
Decrease to current lease and other financing obligations	(32)		
Increase to other current liabilities	32		
Decrease to lease and other financing obligations	(57)		
Increase to other non-current liabilities	57		
Statements of Operations			
Increase to cost applicable to sales		18	32
Decrease to depreciation and amortisation		(16)	(29)
Decrease to interest expense, net of capitalized interest		2	3

7.7 Pro forma historical financial information of the Merged Group continued

k) Reclamation and remediation liabilities

Under US GAAP, the initial recognition of the reclamation and remediation liability is recognised at fair value, generally utilising a present value technique to estimate the liability discounted at a credit-adjusted risk-free interest rate, and further adjusted for inflation and market risk premium. Subsequently, period-to-period revisions to either the timing or amount of the original estimate of undiscounted cash flows are treated as separate layers of the obligation.

Under IFRS, reclamation and remediation liabilities are generally measured as the best estimate of the expenditure to settle the obligation utilising a present value technique to estimate the liability, discounted at a pretax rate that reflects current market assessments of the time value of money and the risks specific to the liability. Subsequently, period-to-period revisions for changes in the estimate of expected undiscounted cash flows or discount rate are re-measured for the entire obligation by using an updated discount rate that reflects current market conditions as of the balance sheet date.

The Merged Group Pro Forma Historical Financial Information does not reflect the impact of converting Newcrest's reclamation and remediation liabilities and related reclamation and remediation expenses on a US GAAP basis as it is impractical to re-estimate the impact of period-to-period revisions to the timing or amount of the original reclamation liability over historical periods using the layering approach and credit-adjusted risk-free rates. In addition, the impact of converting reclamation and remediation liabilities from IFRS to US GAAP is not meaningful because, under the acquisition method of accounting, reclamation and remediation liabilities are recorded at fair value as of the closing date of the Transaction. Therefore, Newmont has reflected the adjustment to recognise *Reclamation and remediation liabilities*, and related reclamation and remediation expense, at their estimated fair value on the Implementation Date. Refer to Note 4(e) in section 7.7(e) below for additional information.

Note 4 – Transaction Accounting Adjustments

The following adjustments have been made to the Merged Group Pro Forma Historical Financial Information to reflect certain preliminary purchase price accounting and other pro forma adjustments. Further review may identify additional adjustments that could have a material impact on the Merged Group Pro Forma Historical Financial Information. At this time, Newmont is not aware of any additional transaction-related adjustments that would have a material impact on the Merged Group Pro Forma Historical Financial Information that are not reflected or disclosed in the pro forma adjustments.

a) Transaction costs and other one-time charges

The increase in *Other expense*, net of \$557 million for the year ended 31 December 2022 and the corresponding increase in *Other current liabilities* of \$557 million, of which \$430 million relates to stamp duty, and a decrease in *Deferred income tax liabilities* of \$47 million as at 30 June 2023, reflects the adjustment to recognise transaction costs and other non-recurring charges expected to be incurred in connection with the Transaction. For the six months ended 30 June 2023, \$21 million and \$14 million were recognised in *Other expense, net* by Newmont and Newcrest within their historical financial information, respectively, relating to transaction costs and non-recurring charges incurred.

b) Inventories and Stockpiles and ore on leach pads

The increase in *Inventories* and decrease in *Stockpiles and ore on leach pads* by \$30 million and \$1,578 million reflect the adjustments to recognise the fair value estimates as of 30 June 2023, respectively.

As a result of the decrease, there was a decrease to Costs applicable to sales of \$76 million and \$168 million for the six months ended 30 June 2023 and the year ended 31 December 2022, respectively, and a decrease to *Depreciation and amortisation* by \$13 million and \$26 million for the six months ended 30 June 2023 and the year ended 31 December 2022, respectively.

c) Property, plant and mine development, net

The adjustment to increase *Property, plant and mine development, net* by \$1,928 million reflects the fair value estimate of property, plant, and mine development as of 30 June 2023, and the related increase to *Depreciation and amortisation* of \$37 million and \$88 million for the six months ended 30 June 2023 and the year ended 31 December 2022, respectively.

d) Investments

The adjustment to increase *Investments* by \$570 million reflects the fair value estimate of equity method investments as of 30 June 2023. The increase in fair value of equity method investments resulted in a basis difference, which is amortised into *Equity income (loss) of affiliates*, resulting in a decrease of \$15 million and \$30 million for the six months ended 30 June 2023 and the year ended 31 December 2022, respectively.

e) Reclamation and remediation liabilities

The fair value of *Reclamation and remediation liabilities* decrease of \$125 million as of 30 June 2023, \$7 million of which is included in *Other current liabilities*, reflects an adjustment to recognise reclamation and remediation liabilities at fair value as of 30 June 2023. The resulting decrease in *Reclamation and remediation expense* and *Depreciation and amortisation* of the related reclamation and remediation liabilities and property, plant and mine development net for the six months ended 30 June 2023 and the year ended 31 December 2022, respectively, is not material.

7. Profile of the Merged Group

7.7 Pro forma historical financial information of the Merged Group continued

f) Debt

The adjustment to current and non-current *Debt* reflects the increase of \$796 million and is comprised of:

- i) a \$298 million reclassification from non-current *Debt* to current *Debt* as a result of the Transaction which will trigger a change of control clause and a potential repayment of the committed unsecured bilateral bank debt facility ("Revolver facility") within 90 days, subject to obtaining a bank waiver;
- ii) a \$188 million decrease in the fair value of Newcrest's assumed \$1,747 million Corporate Bonds as of 30 June 2023; and
- iii) an expected \$984 million increase in the assumed Newcrest Revolver facility as of 30 June 2023. Newcrest expects to utilise its Revolver facility to make the special dividend payment to its shareholders of \$1.10 per Newcrest share immediately prior to the consummation of the Transaction.

As a result of the increase to the *Debt*, *Interest expense, net of capitalised interest* increased by \$36 million and \$71 million for the six months ended 30 June 2023 and the year ended 31 December 2022, respectively.

g) Income taxes

Deferred income taxes have been recognised based on the pro forma IFRS to US GAAP conversion, accounting policy alignment, and fair value adjustments to identifiable assets acquired and liabilities assumed of Newcrest using the statutory tax rate on a jurisdictional basis. In addition, an estimate of the reset in tax basis in the Australian assets has been made, with any fair value uplifts being tax effected. The \$261 million decrease in *Deferred tax liabilities* reflects the preliminary estimate of deferred tax assets and liabilities recognised on the new book to tax basis differences of assets acquired and liabilities assumed.

The estimated income and mining tax expense impact of the pro forma adjustments (except for the impact of certain transaction costs for which no tax benefit is expected due to a valuation allowance) has been recognised based upon the statutory tax rates applicable on a jurisdictional basis.

h) Newcrest shareholders' equity

The adjustment reflects the elimination of \$12,116 million of Newcrest's shareholders' equity, which represents the historical book value of Newcrest's net assets including IFRS to US GAAP and accounting policy adjustments of \$404 million, as a result of the application of purchase price accounting.

The adjustment reflects an increase of \$572 million and decrease of \$38 million to *Common stock* and *Additional paid-in capital*, respectively, to reflect the issuance of 358 million Newmont Shares with a par value of \$1.60 per share to satisfy the issuance of 0.400 Newmont Shares for each Newcrest Share outstanding pursuant to the Scheme, assuming a closing price of Newmont Shares on 3 August 2023 of \$40.44 per share.

In addition, *Retained earnings (accumulated deficit)* and *Accumulated other comprehensive income (loss)* have been adjusted by \$1,044 million and \$771 million, respectively, to eliminate Newcrest's historical equity balances, adjusted for IFRS to US GAAP differences and transaction accounting adjustments as at 30 June 2023.

The table below reflects elimination of Newcrest's shareholders' equity after adjustments for IFRS to US GAAP differences and purchase price accounting and other pro forma adjustments as at 30 June 2023:

\$ millions	Reclassified Historical Newcrest	IFRS to US GAAP and Accounting Policy	Transaction Accounting Adjustments	Equity Adjustments	Pro Forma Newcrest ¹
Common stock	—	—	—	572 ²	572
Additional paid-in capital	13,931	—	—	(38) ³	13,893
Accumulated other comprehensive income (loss)	(779)	8	—	771 ⁴	—
Retained earnings (accumulated deficit)	(1,440)	396	(510)	1,044 ⁵	(510)
Total Newcrest equity	11,712	404	(510)	2,349	13,955

Notes:

1. Excludes Newmont's equity.
2. Represents issuance of 358 million Newmont Shares with a par value of \$1.60 per share in exchange of 894 million Newcrest Shares.
3. Represents adjustment to *Additional paid-in capital*, to record issuance of 358 million shares of Newmont Shares for \$13,893 million, calculated by deducting the \$572 million common stock (see (1) above) from the preliminary purchase consideration of \$14,465 million.
4. Represents adjustment to write-off Newcrest's historical *Accumulated other comprehensive income (loss)* of \$(779) million, net of \$8 million for IFRS to US GAAP and accounting policy adjustments.
5. Represents adjustment to write-off Newcrest's historical *Retained earnings (accumulated deficit)* of \$(1,440) million, net of \$396 million for IFRS to US GAAP and accounting policy adjustments. The remaining \$(510) million represents transaction costs, inclusive of tax impacts, as discussed in Note 4(a) in section 7.7(e).



7.7 Pro forma historical financial information of the Merged Group continued

i) Goodwill

Goodwill is calculated as the difference between the preliminary estimated purchase price and the fair values assigned to the identifiable tangible and intangible assets acquired and liabilities assumed of Newcrest. The fair value of assets acquired and liabilities assumed is preliminary and will be finalised upon completion of the Transaction. Based on the preliminary purchase price allocation, Newmont has recognised \$2,534 million of *Goodwill* after adjusting for \$686 million of reclassified historical Newcrest *Goodwill* in the Merged Group Pro Forma Historical Balance Sheet. This amount may increase or decrease based on the final purchase price allocation. Goodwill recorded in connection with the acquisition is not deductible for income tax purposes.

j) Earnings per share

The pro forma combined diluted earnings per share presented below reflects the adjustment to weighted average number of shares outstanding based on 0.400 Newmont Shares for each Newcrest Share as at 3 August 2023 as follows:

\$ millions, except per share	For the six months ended 30 June 2023	For the year ended 31 December 2022
Pro forma net income (loss) from continuing operations attributable to Newmont Stockholders	\$972	\$(155)
Pro forma basic weighted average Newmont Shares outstanding ¹	1,152	1,152
Pro forma basic earnings (loss) per share	\$0.84	\$(0.13)
Pro forma diluted weighted average Newmont Shares outstanding ²	1,153	1,153
Pro forma diluted earnings (loss) per share ³	\$0.84	\$(0.13)

Notes:

- For the six months ended 30 June 2023 and the year ended 31 December 2022, basic shares outstanding of 1,152 million is comprised of 794 million shares of Newmont common stock and 358 million shares of Newmont common stock to be exchanged for 894 million shares of issued and outstanding Newcrest ordinary shares as of 3 August 2023.
- For the six months ended 30 June 2023 and the year ended 31 December 2022, diluted shares outstanding of 1,153 is comprised of 795 million shares of Newmont common stock and 358 million shares of Newmont common stock to be exchanged for 894 million shares of issued and outstanding Newcrest ordinary shares as of 3 August 2023.
- Potentially dilutive shares were excluded in the computation of diluted loss per share for the year ended 31 December 2022 as they were antidilutive.

Note 5 – Acquisition Method of Accounting

The Transaction will be accounted for using the acquisition method of accounting, as prescribed in *Accounting Standards Codification 805, Business Combinations, (ASC 805)*, under US GAAP, which requires an allocation of the purchase price to the assets acquired and liabilities assumed, based on their fair values as of the date of the Transaction. As of the date of this Scheme Booklet, Newmont has not completed the detailed valuation study necessary to arrive at the required final estimates of the fair value of Newcrest's assets to be acquired and liabilities to be assumed and the related allocations of purchase price.

Material adjustments have been made to reflect Newcrest's historical consolidated financial information on a US GAAP basis for purposes of Merged Group Pro Forma Historical Financial Information and to align Newcrest's historical significant accounting policies under IFRS to Newmont's significant accounting policies under US GAAP. As of the date of this Scheme Booklet, Newmont has not identified all adjustments necessary to convert Newcrest's historical consolidated financial information prepared in accordance with IFRS to US GAAP and to conform Newcrest's accounting policies to Newmont's accounting policies.

A final determination of the fair value of Newcrest's assets and liabilities, including property, plant and mine development, will be based on the actual property, plant and mine development of Newcrest that exist as of the closing date of the Transaction and, therefore, cannot be made prior to the implementation of the Scheme. In addition, the value of the purchase consideration to be paid by Newmont upon the implementation of the Scheme will be determined based on the closing price of Newmont Shares on the Implementation Date. As a result of the foregoing, the pro forma adjustments are preliminary and are subject to change as additional information becomes available and as additional analysis is performed. The preliminary pro forma adjustments have been made solely for the purpose of providing the Merged Group Pro Forma Historical Financial Information presented herein. Newmont has estimated the fair value of Newcrest's assets and liabilities based on discussions with Newcrest's management, preliminary valuation studies, due diligence and information presented in Newcrest's filings with the ASX.

Until the Scheme is implemented, both Newcrest and Newmont are limited in their ability to share certain information. Upon implementation of the Scheme, a final determination of fair value of Newcrest's assets and liabilities will be performed. Any increases or decreases in the fair value of assets acquired and liabilities assumed upon completion of the final valuations will result in adjustments to the Merged Group Pro Forma Historical Financial Information. The final purchase price allocation may be materially different than that reflected in the pro forma purchase price allocation presented herein.

7. Profile of the Merged Group

7.7 Pro forma historical financial information of the Merged Group continued

Purchase Consideration

The total preliminary estimated purchase price of approximately \$14,465 million was determined as of 3 August 2023, based on Newcrest's issued and outstanding ordinary shares, which includes equity awards outstanding under Newcrest's equity incentive plans that are expected to vest before the close of the Transaction. The number of shares of Newmont common stock to be issued is based on the number of Newcrest ordinary shares outstanding multiplied by the 0.400 exchange ratio, adjusted for fractional shares.

The final purchase consideration will be based on the actual closing price per share of Newmont common stock on the closing date, which could differ materially from the assumed Newmont common stock price used to estimate purchase consideration for the purposes of the Merged Group Pro Forma Historical Financial Information. For purposes of the Merged Group Pro Forma Historical Financial Information, such common stock and equity awards are assumed to remain outstanding as of the closing date of the Transaction. Further, no effect has been given to any other new Newcrest ordinary shares or other equity awards that may be issued or granted subsequent to the date of this Scheme Booklet and before the closing date of the Transaction.

In all cases in which Newmont's closing stock price is a determining factor in arriving at the final purchase consideration, the stock price assumed for the total preliminary purchase price is the closing price of Newmont's common stock on 3 August 2023 (\$40.44 per share), the most recent date practicable prior to the mail date of this Scheme Booklet. A hypothetical 10 percent change in Newmont's closing stock price as of 3 August 2023, would have an approximate \$1,447 million impact on the purchase price, which would result in \$1,447 million additional goodwill or a reduction to goodwill of \$1,447 million.

\$ millions, except share and per share data	Shares	Per Share	Preliminary Purchase Consideration
Stock Consideration			
Shares of Newmont exchanged for Newcrest outstanding ordinary shares ¹	357,692,293	\$40.44	\$14,465
Total Preliminary Purchase Price			\$14,465

Note:

- Assumes that 358 million shares of Newmont Shares will be exchanged for 894 million shares of issued and outstanding Newcrest Shares as of 3 August 2023. Newcrest Shareholders will receive 0.400 of a share of Newmont common stock, par value \$1.60 per Newmont Share.

Preliminary Purchase Price Allocation

The table below summarises the preliminary allocation of purchase price to the assets acquired and liabilities assumed of Newcrest for the purposes of the Merged Group Pro Forma Historical Financial Information as if the Transaction had occurred on 30 June 2023:

Preliminary Purchase Price Allocation	\$ millions
Cash and cash equivalents	586
Trade receivables	143
Investments	1,050
Inventories	574
Stockpiles and ore on leach pads	290
Property, plant & mine development, net	15,018
Deferred income tax assets	50
Goodwill	2,534
Other assets	865
Total assets	21,110
Debt	2,731
Accounts payable	679
Employee-related benefits	383
Income and mining tax payable	37
Lease and other financing obligations	21
Reclamation and remediation liabilities	381
Deferred income tax liabilities	2,274
Other liabilities	139
Total liabilities	6,645
Total Preliminary Purchase Price	14,465

The *Goodwill* balance is comprised of amounts attributable to the assembled workforce, operating synergies anticipated upon the integration of the operations of Newmont and Newcrest, potential strategic and financial benefits, including the financial flexibility to execute capital priorities, and new book to tax basis differences of assets acquired and liabilities assumed.



7.8 Newmont Shares and Newmont CDIs

a) Newmont Shares

The Newmont Shares provided as Scheme Consideration will rank equally in all respects with all other Newmont Shares on issue from the time of issue. The Newmont Shares will be listed and traded on NYSE and TSX. Newmont has agreed to use its best endeavours to ensure that the Newmont Shares provided as Scheme Consideration are approved by NYSE and TSX and ensure that trading in the Newmont Shares commences on a normal settlement basis on NYSE and TSX from the first Business Day after the Implementation Date (New York time). Newmont Shares will not be quoted or traded on ASX. Accordingly, investors who wish to trade Newmont Shares on the open market must do so on NYSE or TSX. Such trades must be undertaken through a broker entitled to trade on NYSE or TSX. It is the responsibility of Newcrest Shareholders to ensure that appropriate arrangements are in place if they wish to hold and trade Newmont Shares on NYSE or TSX.

As trading in Newmont Shares on NYSE will be in US dollars, and on TSX in Canadian dollars, the Australian dollar value of the Newmont Shares will depend on the AUD:USD and AUD:CAD exchange rate.

b) Newmont CDIs

CDIs are a type of depository receipt, used to enable trading on the ASX of financial products issued by entities domiciled in countries whose laws may not recognise uncertificated holders or electronic transfer of title through CHES, and to allow investors in the Australian market to obtain all the economic benefits of owning foreign securities without actually holding legal title to them.

A CDI represents a unit of beneficial ownership in an underlying security that is held on trust for the CDI holder by CDN. This allows investors to trade interests in foreign securities on the ASX by trading the relevant CDIs.

In the case of the Newmont CDIs provided as Scheme Consideration, each Newmont CDI will represent a beneficial interest in one Newmont Share and will have rights that are economically equivalent to the rights attaching to a Newmont Share, except for certain differences noted in section 7.8(d).

Newmont will issue the Newmont Shares to which the Newmont CDIs relate to CDN, who will hold legal title to those Newmont Shares on behalf of the holders of the Newmont CDI holders. Currently, CDN is the only depository nominee offering CDI services for ASX quoted securities. CDN will issue the Newmont CDIs to relevant Scheme Shareholders in parallel.

Newmont CDIs will be quoted and traded on the ASX in Australian dollars under the symbol "NEM". Newmont CDIs will not be quoted or traded on NYSE or TSX.

c) Key features of Newmont CDIs

1) General

Except for certain differences noted in section 7.8(d), the rights attached to Newmont CDIs are economically equivalent to the rights attaching to Newmont Shares, and Newmont will generally be required to treat holders of Newmont CDIs as if they were holders of the Newmont Shares represented by those Newmont CDIs.

2) Ratio

Each Newmont CDI will represent one Newmont Share.

3) Voting

Holders of Newmont CDIs will be sent notices of meetings of Newmont Stockholders at the same time as they are sent to Newmont Stockholders.

As holders of Newmont CDIs are not registered holders of the Newmont Shares represented by Newmont CDIs, they will not be automatically entitled to vote at a meeting of Newmont Stockholders. However, the holder of a Newmont CDI can direct CDN to cast votes in a particular manner on their behalf to exercise the votes attaching to the Newmont Shares represented by the holder's Newmont CDIs.

Except as mentioned in this section 7.8(c)(3), if a holder of a Newmont CDI wishes to vote at a meeting of Newmont Stockholders in their personal capacity, the holder must first transmute their Newmont CDIs into the underlying Newmont Shares in sufficient time before the record date for the meeting.

4) Takeovers

Under the ASX Settlement Rules, CDN will not accept a takeover offer in respect of any Newmont CDIs representing Newmont Shares unless instructed to do so by holders of Newmont CDIs. It is CDN's responsibility to ensure that the bidder processes those acceptances.

5) Communications from Newmont

Newmont will communicate directly with holders of Newmont CDIs with respect to corporate actions. To the extent practicable, Newmont will send notices and other documents (e.g. notices of meetings) to holders of Newmont CDIs at the same time as they are sent to Newmont Stockholders.

7. Profile of the Merged Group

7.8 Newmont Shares and Newmont CDIs

6) Trading

Following quotation of the Newmont CDIs on the ASX, Newmont CDIs can be traded on the ASX. Newmont CDIs will not be tradeable on NYSE or TSX. If a holder of Newmont CDIs wishes to trade on NYSE or TSX, they must transmute the Newmont CDIs into Newmont Shares (see section 7.8(c)(9)).

7) Dividends

In accordance with the ASX Settlement Rules, Newmont will distribute any dividend declared on Newmont Shares directly to holders of Newmont CDIs.

Dividend record and payment dates will be the same for Newmont Shares and Newmont CDIs. See section 7.3(d) for further details on Newmont's intentions in relation to dividends.

8) Evidence of ownership

If Newmont CDIs are issued to you under the Scheme, you will receive a holding statement or confirmation advice in respect of your Newmont CDIs rather than a holding statement for the underlying Newmont Shares. Revised holding statements will be provided on a periodic basis if there is a change in the number of Newmont CDIs held by you. Newmont CDIs may be held on an issuer sponsored subregister or on a CHESSE subregister.

Newmont CDIs issued under the Scheme will be received:

- on the Newmont CDI issuer sponsored subregister, to the extent they are issued for Newcrest Shares held on the Newcrest issuer sponsored subregister as at the Record Date; and
- on the Newmont CDI CHESSE subregister, to the extent they are issued for Newcrest Shares held on the Newcrest CHESSE subregister as at the Record Date.

9) Converting Newmont CDIs to Newmont Shares

Holders of Newmont CDIs may at any time (following the Implementation Date) request to convert (or "transmute") their Newmont CDIs into Newmont Shares listed on NYSE by contacting:

- the Newmont CDI registry, if their Newmont CDIs are held directly on the Newmont CDI issuer sponsored subregister. Newmont CDI holders will be provided with a CDI cancellation request form for completion and return to the Newmont CDI registry; or
- their sponsoring participant (usually their broker), if their Newmont CDIs are held on the Newmont CDI CHESSE subregister. In this case, your sponsoring broker will arrange for completion of the relevant form and its return to the Newmont CDI registry.

The Newmont CDI registry will then arrange for the transfer of Newmont Shares from CDN to the former Newmont CDI holder and, depending on the request made, issue the Newmont Shares to the former Newmont CDI holder in book-entry form directly on the United States share register or deliver to their account held with a participant within The Depository Trust Company, United States central securities depository. Trading on the ASX will no longer be possible.

It is expected that requests for conversion will ordinarily be processed by the next business day, provided that the Newmont CDI registry is in receipt of a duly completed and valid CDI cancellation request form. However, no guarantee can be given about the time for this conversion to take place.

The Newmont CDI registry will not charge an individual Newmont CDI holder a fee for transmuting Newmont CDIs into Newmont Shares, although a cross-border transaction fee may be charged by any intermediaries.

No trading of the underlying Newmont Shares can take place on NYSE until the conversion process has been completed. The decision whether to transmute Newmont CDIs to Newmont Shares will depend on your individual circumstances. You should seek advice from your own independent and appropriately licensed financial, legal and tax advisers before deciding whether to transmute Newmont CDIs to Newmont Shares.

10) Converting Newmont Shares to Newmont CDIs

Newcrest Shareholders that receive Newmont Shares instead of Newmont CDIs, and existing Newmont Stockholders, may at any time (following the Implementation Date) transmute them into Newmont CDIs by contacting the Newmont Share registry in the United States. The Newmont Share registry will not charge a fee to a shareholder seeking to transmute Newmont Shares to CDIs, although a cross-border transaction fee may be charged by any intermediaries.

In this instance, underlying Newmont Shares will be transferred to CDN and a holding statement for the Newmont CDIs will be issued to the relevant security holder. No trading in Newmont CDIs on the ASX can take place until this conversion process is complete.

The decision whether to transmute Newmont Shares to Newmont CDIs will depend on your individual circumstances. You should seek advice from your own independent and appropriately licensed financial, legal and tax adviser before deciding whether to transmute Newmont Shares to Newmont CDIs.

7.8 Newmont Shares and Newmont CDIs

d) Differences between holding Newmont Shares and Newmont CDIs

1) Principal differences between holding Newmont Shares and Newmont CDIs

The principal difference between holding a Newmont CDI and holding a Newmont Share is that the holder of a Newmont CDI has an indirect, beneficial interest in the Newmont Share underlying their Newmont CDI instead of directly owning the Newmont Share. This means that the holder of the Newmont CDI is not the registered legal holder of the underlying Newmont Share and therefore:

- cannot directly trade the underlying Newmont Share; and
- is a beneficial holder (rather than a registered legal holder) of the underlying Newmont Share.

2) Other differences

A) Exercise of shareholder rights

As holders of Newmont CDIs are not registered Newmont Stockholders, the rights attaching to Newmont Shares which underlie their Newmont CDIs must be exercised by CDN. A holder of Newmont CDIs may instruct CDN to exercise those rights on their behalf.

In contrast, a registered Newmont Stockholder can directly exercise the rights attaching to their Newmont Shares in such a manner as they choose. For example, as described above, a holder of a Newmont CDI cannot vote directly at a Newmont Stockholder meeting in their personal capacity as a Newmont Stockholder but can direct CDN how to vote at that Newmont Stockholder meeting.

B) *Newmont CDIs will be quoted and trade on the ASX and Newmont Shares will be quoted and trade on NYSE and TSX*

Newmont Shares will be tradeable on NYSE and TSX only. They will not be quoted or tradeable on the ASX.

Accordingly, investors who wish to trade Newmont Shares on the open market must do so on NYSE and TSX. Such trades must be undertaken through a broker entitled to trade on NYSE and TSX. It is the responsibility of Scheme Shareholders to ensure that appropriate arrangements are in place if they wish to hold and trade Newmont Shares on NYSE.

Newmont CDIs will be tradeable on the ASX only. This may be attractive to Newcrest Shareholders, as it allows Newmont CDIs to be traded during Australian business hours using Australian brokers in prices quoted in AUD.

See section 8.4 for further discussion of the liquidity of the market for Newmont CDIs and the potential risk that they may trade at a discount to Newmont Shares on NYSE and/or TSX.

e) Newmont Foreign Exempt Listing on the ASX

Newmont intends to apply for admission to the official list of the ASX as a Foreign Exempt Listing, subject to customary conditions and the Scheme becoming Effective.

Once listed on the ASX as a Foreign Exempt Listing, Newmont will be exempt from complying with most of the ASX Listing Rules. However, ASX Listing Rules with regard to Foreign Exempt Listings will apply to Newmont, including:

- providing the ASX with copies of its public filings;
- continuing to comply with the NYSE Listing Rules;
- registering as a foreign company carrying on business in Australia under the Corporations Act; and
- complying with certain ASX Listing Rules concerning procedural and administrative matters, including lodging announcements, trading halt, suspension and removal.

f) Commencement of trading of Newmont Shares and Newmont CDIs

Deferred settlement trading of Newmont CDIs is expected to be available on the ASX from Friday, 27 October 2023. Newmont CDIs are expected to commence trading on the ASX on a normal settlement basis on the ASX from Tuesday, 7 November 2023.

Trading of Newmont Shares on NYSE and TSX is expected to commence on the Business Day after the Implementation Date on Monday, 6 November 2023 (Eastern Time).

g) Newmont PDIs

See section 11.6 for information regarding Newmont PDIs.

8. Risks

8.1 Overview

In considering the Scheme, Newcrest Shareholders should be aware that there are a number of risks, both general and specific, associated with the Scheme. This section 8 describes a number of risks associated with:

- the business and operations of the Merged Group (section 8.2);
- Newmont Shares and Newmont CDIs (section 8.3); and
- the Newcrest Group if the Scheme is not implemented (section 8.4).

A number of these risks are, or will be, risks to which Newcrest Shareholders are already exposed. However, the nature of the Merged Group's business will differ from that of Newcrest as a standalone business and Newcrest Shareholders may be subject to additional risks in respect of the Merged Group.

In deciding whether to vote in favour of the Scheme, Newcrest Shareholders should read this Scheme Booklet in full and consider the risks. These risks do not take into account the individual investment objectives, financial situation, position or particular needs of Newcrest Shareholders. In addition, this section 8 is a summary only and is not an exhaustive list of all risks related to the Merged Group, Newmont Shares and Newmont CDIs, Newcrest, and the Scheme. There may be additional risks and uncertainties not currently known to Newcrest or Newmont or that are currently considered immaterial, which may become important factors that can have a material adverse effect on the Merged Group's operating and financial performance.

Sections 8.2 and 8.3 have been prepared by Newmont. Newcrest and its officers and advisers do not assume any responsibility for the accuracy or completeness of this information.

8.2 Risks relating to the business and operations of the Merged Group

This section 8.2 sets out some of the key risks relating to the business and operations of the Merged Group.

a) Change in risk and investment profile

On and from the Implementation Date, Newcrest Shareholders who receive Newmont Securities under the Scheme will be exposed to risks relating to Newmont, the Merged Group and the integration of Newcrest and Newmont.

b) Failure to realise benefits, including synergies

On and from the Implementation Date, the Merged Group will pursue those strategies, operational objectives and benefits contemplated by this Scheme Booklet, including the synergies detailed in section 7.2.

There is a risk that the Merged Group may not achieve the strategies, operational objectives and benefits (in whole or in part) or that they will not materialise, or will not materialise to the extent that the Merged Group contemplates, or they will be delayed. This may occur due to matters beyond the control of the Merged Group. A failure to achieve these strategies, operational objectives and benefits could have an adverse impact on the Merged Group's operations, financial performance and financial position.

There is also a risk that the Merged Group will not benefit (in whole or in part) from the synergies detailed in section 7.2, or they will be delayed.

c) Integration risk

The success of the Scheme and the Merged Group will depend on, among other things, the ability of the Merged Group to realise the anticipated benefits from combining the businesses of Newmont and Newcrest. The Merged Group's ability to realise these anticipated benefits depends on the successful integration of the Newmont and Newcrest businesses. This will be a complex and time consuming process.

Newmont expects that value can be added by acquiring all Newcrest Shares. However, the risk exists that the integration of the Newcrest and Newmont businesses may take longer than expected and integration is achieved over a longer time period than expected. This may impact the Merged Group's financial performance.

8.2 Risks relating to the business and operations of the Merged Group *continued*

d) Risks related to the Scheme

1) There are significant transaction and transaction-related costs in connection with the Scheme

Both Newmont and Newcrest have, and will, incur significant costs associated with the Scheme and combining the Newmont and Newcrest businesses. Fees and expenses related to the Scheme include financial adviser fees, filing fees, taxes, legal and accounting fees, soliciting fees and regulatory fees. Some of these fees will be paid regardless of whether the Scheme is implemented or becomes Effective. The Merged Group will incur costs associated with combining the two companies, however it is difficult to predict the amount of these costs before the integration process begins. The Merged Group may incur additional unanticipated costs as a consequence of difficulties arising from efforts to integrate the companies.

2) The Scheme is subject to satisfaction or waiver of a number of conditions

The Scheme is conditional upon, among other things:

- approval by the Newmont Stockholders of the issuance of the Newmont Shares (proposed to be issued to Newcrest Shareholders in exchange for their Newcrest Shares or proposed to underlie the issue of Newmont CDIs or Newmont PDIs to Newcrest Shareholders in exchange for their Newcrest Shares, as applicable) pursuant to the Scheme Implementation Deed;
- approval by the Newcrest Shareholders of the Scheme and by the Court of the Scheme; and
- Newmont and Newcrest's receipt of certain regulatory approvals, including approval of competition or antitrust authorities in Australia, Canada, Japan, PNG, South Korea and the Philippines and foreign investment authorities in Australia. As at the date of this Scheme Booklet, clearance has been received from the Canadian Competition Bureau, the ICCC, the Korea Fair Trade Commission and the Australian Competition and Consumer Commission.

In addition, certain regulatory approvals will need to be obtained in connection with the Scheme that are not conditions to the Scheme. The regulatory approval processes may take a lengthy period of time to complete. There can be no assurance that any or all such approvals will be obtained or will be obtained in a timely manner. Even if such approvals or conditional approvals are obtained, no assurance can be given as to the terms, conditions and timing of the approvals or whether they will be acceptable to Newmont (in terms of any impact on the Scheme or the Merged Group's operations). In addition, Newmont and Newcrest may waive certain of these conditions either before or after the special meeting of Newmont Stockholders without requiring the further approval of Newmont Stockholders.

3) The Scheme Implementation Deed may be terminated in certain circumstances

Each of Newmont and Newcrest has the right to terminate the Scheme Implementation Deed in certain circumstances. For instance, either party may terminate the Scheme Implementation Deed if there is or may be a failure of a Condition Precedent to be satisfied or waived (where capable of waiver) in accordance with its terms and Newmont and Newcrest are unable to agree on a revision to the terms of the Scheme Implementation Deed after such failure of the Condition Precedent or the Scheme has not become Effective by 11:59pm (Melbourne time) on the End Date. Failure to complete the Scheme could negatively impact the trading price of Newmont Shares or otherwise adversely affect Newmont's business.

4) Newmont does not currently control Newcrest and its Subsidiaries

Newmont will not control Newcrest and its Subsidiaries until the Implementation Date and the business and results of operations of the Merged Group may be adversely affected by events that are outside of the Merged Group's control during the intervening period. The performance of Newcrest may be influenced by, among other factors, economic downturns, changes in commodity prices, political instability in the countries in which Newcrest operates, changes in applicable laws, expropriation, increased environmental regulation, volatility in the financial markets, unfavourable regulatory decisions, litigation, regulatory action, rising costs, civil and labour unrest, disagreements with joint venture partners, delays in ongoing exploration and development projects and other factors beyond the Merged Group's control. As a result of any one or more of these factors, among others, the operations and financial performance of Newcrest may be negatively affected, which may adversely affect the future financial results of the Merged Group.

8. Risks

8.2 Risks relating to the business and operations of the Merged Group *continued*

5) Newcrest and Newmont may be the targets of legal claims, securities class actions, derivative lawsuits and other claims and negative publicity related to the Scheme

Newcrest and Newmont may be the target of securities class actions and derivative lawsuits related to the Scheme which could result in substantial costs and may delay or prevent implementation of the Scheme. Securities class action lawsuits and derivative lawsuits may be brought against companies that have entered into an agreement to acquire a public company or to be acquired. Third parties may also attempt to bring claims against Newmont or Newcrest seeking to restrain the Scheme or seeking monetary compensation or other remedies. Even if the lawsuits are without merit, defending against these claims can result in substantial costs and divert management time and resources. Additionally, if a plaintiff is successful in obtaining an injunction prohibiting implementation of the Scheme, then that injunction may delay or prevent implementation.

In addition, political and public attitudes towards the Scheme could result in negative press coverage and other adverse public statements affecting Newmont and Newcrest. Adverse press coverage and other adverse statements could lead to investigations by regulators, legislators and law enforcement officials or in legal claims or otherwise negatively impact the ability of the Merged Group to take advantage of various business and market opportunities. The direct and indirect effects of negative publicity, and the demands of responding to and addressing it, may have a material adverse effect on the Merged Group's business, financial condition and results of operations.

6) The exchange ratio is fixed and will not be adjusted in the event of any change in either Newmont's or Newcrest's share price

Upon implementation of the Scheme, Newcrest Shareholders as of the Scheme Record Date will be entitled to receive, for each Newcrest Share, 0.400 Newmont Securities.

This exchange ratio was fixed in the Scheme Implementation Deed and will not be adjusted to reflect changes in the market price of either Newcrest Shares or Newmont Shares before the Implementation Date. Share price changes may result from a variety of factors (many of which are beyond Newmont's and Newcrest's control), including the following:

- changes in Newmont's and Newcrest's respective businesses, operations and prospects;
- investor behaviour and strategies, including market assessments of the likelihood that the Scheme will be implemented, including related considerations regarding Court approval and regulatory clearance of the Scheme;
- interest rates, general market and economic conditions and other factors generally affecting the price of Newmont Shares and Newcrest Shares; and
- federal, state and local legislation, governmental regulation and legal developments in the businesses in which Newmont and Newcrest operate.

The price of a Newmont Share at the Implementation Date will vary from its price on the date on which the Scheme Implementation Deed was executed, on the date of this Scheme Booklet and on the date of the Scheme Meeting. As a result, the market value represented by the exchange ratio will also vary. For example, based on the range of closing prices of Newmont Shares during the period from 12 May 2023, the last trading day before public announcement of the Scheme Implementation Deed, through the Last Practicable Date, the exchange ratio represented a market value ranging from a low of \$16.38 to a high of \$19.94 for each Newcrest Share. Therefore, because the exchange ratio is fixed, prior to the implementation of the Scheme, Newcrest Shareholders cannot be sure of the market value of the consideration that will be issued to Newcrest Shareholders on the Implementation Date.

7) Market response to the Scheme or significant delays in implementation of the Scheme could negatively affect the price of Merged Group shares or have an adverse impact on the Merged Group's business and operations

The market price of the Merged Group shares may vary significantly from the price on the date of the Scheme Implementation Deed. Negative market response to the Scheme or any significant delays in implementation of the Scheme could negatively affect the Merged Group share price.

In addition, there can be no assurance that the Conditions Precedent under the Scheme Implementation Deed will be satisfied in a timely manner or at all. If implementation of the Scheme is delayed, the market price of Newmont Shares (and therefore the Merged Group shares) may decline significantly, particularly to the extent the market price reflects a market assumption that the Scheme will be implemented in a particular timeframe. Share price changes may result from a variety of factors that are beyond the Merged Group's control, including:

- market assessment of the likelihood of the Scheme being implemented;
- changes in the respective businesses, operations or prospects of Newmont or Newcrest, including their respective ability to meet earnings estimates;
- governmental or litigation developments or regulatory considerations affecting Newmont or Newcrest or the mining industry;
- general business, market, industry or economic conditions;
- the worldwide supply/demand balance for gold and copper and the prevailing commodity price environment; and
- other factors beyond the Merged Group's control, including those described elsewhere in this section 8.

8.2 Risks relating to the business and operations of the Merged Group *continued*

e) Risks related to implementation of the Scheme

1) Significant demands will be placed on the Merged Group as a result of the Scheme

As a result of the pursuit and implementation of the Scheme, significant demands will be placed on the managerial, operational and financial personnel and systems of the Merged Group. There can be no assurance that the systems, procedures and controls of Newmont and Newcrest will be adequate to support the expansion of operations and associated increased costs and complexity following and resulting from implementation of the Scheme. The future operating results of the Merged Group will be affected by the ability of its officers and key employees to manage changing business conditions, to integrate Newcrest, to implement a new business strategy and to improve its operational and financial controls and reporting systems.

2) The Merged Group may not realise the anticipated benefits of the Scheme and the integration of Newcrest may not occur as planned

The Scheme has been pursued by Newmont with the expectation that its implementation will result in an increase in sustained profitability, cost savings and enhanced growth opportunities for the Merged Group. These anticipated benefits will depend in part on whether Newcrest's and Newmont's operations can be integrated in an efficient and effective manner. A significant number of operational and strategic decisions and certain staffing decisions with respect to integration of the two companies have not yet been made. These decisions and the integration of the two companies will present challenges to management, including the integration of systems and personnel of the two companies which may be geographically separated, anticipated and unanticipated liabilities, unanticipated costs (including substantial capital expenditures required by the integration) and the loss of key employees.

The performance of the Merged Group's operations after implementation could be adversely affected if, among other things, the Merged Group is not able to achieve the anticipated savings and synergies expected to be realised in pursuing the Scheme, or retain key employees to assist in the integration and operation of Newcrest and Newmont. The implementation of the Scheme may pose special risks, including one-time write-offs, restructuring charges and unanticipated costs. In addition, the integration process could result in diversion of the attention of management and disruption of existing relationships with suppliers, employees, customers and other constituencies of each company. Although Newmont and its advisors have conducted due diligence on the operations of Newcrest, there can be no guarantee that Newmont is aware of any and all liabilities of the Newcrest group. As a result of these factors, it is possible that certain benefits expected from the combination of Newcrest and Newmont may not be realised.

3) The Merged Group's public filings will be subject to United States disclosure standards, which differ from Australian disclosure requirements

Newmont is (and therefore the Merged Group will be) a United States issuer that is required to prepare and file its periodic and other filings in accordance with United States securities laws. As a result, certain information about Newmont that is contained in this Scheme Booklet, including any financial statements, was prepared in accordance with United States disclosure regulations, rather than the requirements that would apply to Newcrest or other issuers in Australia. Because United States disclosure requirements are different from Australian disclosure requirements, the information about Newmont contained in its proxy statements and other public filings including any financial statements may not be comparable to similar information available about Newcrest or other Australian issuers.

Please refer to section 10 for a comparison of relevant Australian and United States laws as they relate to Newcrest and Newmont (and therefore the Merged Group).

In addition, Newmont's mineral reserve and mineral resource estimates have been prepared in accordance with Subpart 1300. Newcrest's reporting of mineral reserves and mineral resource estimates complies with the reporting requirements of, and is based on, the confidence categories defined in the JORC Code, and the reporting requirements of the ASX Listing Rules Chapter 5, as well as NI 43-101 and the rules of the TSX, all of which differ from the requirements of Subpart 1300. Newcrest has not been involved in the preparation of Newmont's mineral reserves and mineral resources.

Subpart 1300 and the JORC Code have similar goals in terms of conveying an appropriate level of confidence in the disclosures being reported, but embody different approaches and definitions. See section 11.12(b) for a comparison of key terms used in JORC Code and Subpart 1300.

Expectations regarding the mineral reserves and mineral resources of Newmont and Newcrest following the implementation of the Scheme will remain subject to adjustment, pending continuing review of Newcrest's mineral resources in accordance with Subpart 1300. Future adjustment may occur due to differing standards, required study levels, price assumptions, future divestments and acquisitions and other factors. No assurances can be made that all historical Newcrest Ore Reserves or Mineral Resources will be recognised as Newmont mineral reserves or mineral resources and any differences may be material.

8. Risks

8.2 Risks relating to the business and operations of the Merged Group *continued*

4) The Merged Group Pro Forma Historical Financial Information is presented for illustrative purposes only and may not be indicative of the results of operations or financial condition of the Merged Group following implementation of the Scheme

The Merged Group Pro Forma Historical Financial Information included in section 7.7 is presented for illustrative purposes only to show the effect of implementation of the Scheme, and should not be considered to be an indication of the financial condition or results of operations of the Merged Group following implementation. For example, the Merged Group Pro Forma Historical Financial Information has been prepared using the historical consolidated financial statements of Newmont and of Newcrest for certain specific periods and do not represent a financial forecast or projection. The Merged Group Pro Forma Historical Financial Information in section 7.7 is based in part on certain assumptions regarding the Scheme and certain adjustments and assumptions have been made regarding the Merged Group after giving effect to the Scheme. The information upon which these adjustments and assumptions have been made is preliminary, and these types of adjustments and assumptions are difficult to make with complete accuracy, and other factors may affect the Merged Group's results of operations or financial condition following implementation of the Scheme.

In addition, in preparing the Merged Group Pro Forma Historical Financial Information contained in this Scheme Booklet, effect has been given to, among other things, implementation of the Scheme and the issuance of the Scheme Consideration. The Merged Group Pro Forma Historical Financial Information does not reflect all of the costs that are expected to be incurred in connection with the Scheme. For example, the impact of any incremental costs incurred in integrating Newmont and Newcrest is not reflected in the Merged Group Pro Forma Historical Financial Information. See the notes to the Merged Group Pro Forma Historical Financial Information in section 7.7 for further details.

Accordingly, the Merged Group Pro Forma Historical Financial Information included in this Scheme Booklet does not necessarily represent the Merged Group's results of operations and financial condition had Newmont and Newcrest operated as a combined entity during the periods presented, or of the Merged Group's results of operations and financial condition following implementation of the Scheme.

The actual financial condition and results of operations of the Merged Group following implementation may not be consistent with, or evident from, the Merged Group Pro Forma Historical Financial Information. In addition, the assumptions used in preparing the Merged Group Pro Forma Historical Financial Information may not prove to be accurate, and other factors may affect the Merged Group's financial condition or results of operations following implementation of the Scheme. Any potential decline in the Merged Group's financial condition or results of operations may cause a significant decrease in the Merged Group share price.

5) The Merged Group will face new political risks in certain jurisdictions in which Newcrest operates

Newcrest's principal operations, development and exploration activities will expose the Merged Group to new jurisdictions, including PNG, Ecuador and Fiji, some of which may be considered to have an increased degree of political and sovereign risks. Newcrest conducts operations, development and exploration activities and holds significant investments in Australia, the United States, Chile, PNG, Canada, Ecuador and Fiji. Any material adverse changes in the government policies or legislation of such countries or any other country in which Newcrest has economic interests may affect the viability and profitability of the Merged Group following implementation of the Scheme.

While the governments in PNG, Ecuador and Fiji have historically supported the development of natural resources by foreign companies, there is no assurance that such governments will not in the future adopt different regulations policies or interpretations with respect to, but not limited to, foreign ownership of mineral resources, royalty rates, taxation, rates of exchange, environmental protection, labour relations, repatriation of income or return of capital, restrictions on production or processing, price controls, export controls, currency remittance, or Newcrest's obligations under its respective mining codes and stability conventions. The possibility that such governments may adopt substantially different policies or interpretations, which might extend to the expropriation of assets, may have a material adverse effect on the Merged Group following implementation of the Scheme. Political risk also includes the possibility of terrorism, civil or labour disturbances and political instability. No assurance can be given that applicable governments will not revoke or significantly alter the conditions of the applicable exploration and mining authorisations nor can assurance be given that such exploration and mining authorisations will not be challenged or impugned by third parties. The effect of any of these factors may have a material adverse effect on the Merged Group's results of operations and financial condition.

6) Implementation of the Scheme may result in one or more ratings organisations taking actions which may adversely affect the Merged Group's business, financial condition and operating results, as well as the market price of the Merged Group's shares

Rating organisations regularly analyse the financial performance and condition of companies and may re-evaluate the Merged Group's credit ratings following implementation of the Scheme. Factors that may impact the Merged Group's credit ratings include debt levels, planned asset purchases or sales and near-term and long-term production growth opportunities, liquidity, asset quality, cost structure, product mix and commodity pricing levels. If a ratings downgrade were to occur in connection with the Scheme, the Merged Group could experience higher borrowing costs in the future and more restrictive covenants which would reduce profitability and diminish operational flexibility. No assurance can be provided that Newmont's current ratings will remain in effect following implementation of the Scheme for any given period of time or that a rating will not be lowered by a rating agency if, in its judgment, circumstances so warrant.

7) The Merged Group will face new legislation and tax risks in certain Newcrest operating jurisdictions

Newcrest has operations and conducts business in certain jurisdictions in which Newmont does not currently operate or conduct business, including PNG and Fiji, which may increase the Merged Group's susceptibility to sudden tax changes. Taxation laws in these jurisdictions are complex, subject to varying interpretations and applications by the relevant tax authorities and subject to changes and revisions in the ordinary course. In addition, following implementation of the Scheme, the Merged Group may be subject to tax liabilities that may exist at Newcrest or that may arise in connection with the implementation of the Scheme which are currently unknown. Any unexpected taxes imposed on the Merged Group could have a material and adverse impact on the Merged Group's financial position.

8.2 Risks relating to the business and operations of the Merged Group *continued*

8) Failure by Newmont or Newcrest to comply with applicable laws prior to the Scheme could subject the Merged Group to penalties and other adverse consequences following implementation of the Scheme

Newcrest is subject to anti-corruption and anti-bribery laws, including the United States Foreign Corrupt Practices Act, the Australian *Criminal Code Act 1995* (Cth) and the Corruption of Foreign Public Officials Act (Canada). The foregoing laws prohibit companies and their intermediaries from making improper payments to officials, require the maintenance of records relating to such transactions and also require an adequate system of internal controls. The Merged Group may be liable for any violation of the foregoing laws attributable to Newmont or Newcrest prior to implementation of the Scheme.

Newcrest and Newmont are also subject to a wide variety of laws relating to the environment, health and safety, taxes, employment, labour standards, money laundering, terrorist financing and other matters. Failure by Newmont or Newcrest to comply with any of the foregoing legislation prior to the Implementation Date could result in severe criminal or civil sanctions, and may subject the Merged Group to other liabilities, including fines, prosecution and reputational damage, all of which could have a material adverse effect on the business, consolidated results of operations and consolidated financial condition of the Merged Group following implementation of the Scheme. The compliance mechanisms and monitoring programs adopted and implemented by Newmont or Newcrest prior to implementation may not adequately prevent or detect possible violations of such applicable laws. Investigations by governmental authorities related to any actual or perceived violation of the foregoing laws could also have a material adverse effect on the business, consolidated results of operations and consolidated financial condition of the Merged Group following implementation of the Scheme.

9) The pendency of the Scheme may cause disruptions in Newcrest's and Newmont's business, which could have an adverse effect on the Merged Group's business, financial condition or results of operations

Parties with which Newmont and Newcrest do business may experience uncertainty associated with the Scheme, including with respect to current or future business relationships with Newmont, Newcrest or the Merged Group. Newmont's and Newcrest's relationships may be subject to disruption as customers, suppliers and other persons with whom Newmont and Newcrest have a business relationship may delay or defer certain business decisions or might decide to seek to terminate, change or renegotiate their relationships with Newmont or Newcrest, as applicable, or consider entering into business relationships with parties other than Newmont or Newcrest. In addition, Newmont's current and prospective associates may experience uncertainty about their future roles, which might adversely affect Newmont's ability to attract and retain key personnel and key management and other employees may be difficult to retain or may become distracted from day-to-day operations because matters related to the Scheme may require substantial commitments of their time and resources. These disruptions could have an adverse effect on the results of operations, cash flows and financial position of Newmont, Newcrest or the Merged Group following implementation of the Scheme, including an adverse effect on the Merged Group's ability to realise the expected synergies and other benefits of the Scheme. The risk, and adverse effect, of any disruption could be exacerbated by a delay in implementation of the Scheme or the termination of the Scheme Implementation Deed.

f) Risks related to the Merged Group's business and operations

The Merged Group and its business and industry will be subject to a number of business and operational risks, including risks that are outside of its control, which could negatively impact on the Merged Group's actual results. A non-exhaustive summary of these risks is set out in this section 8.2(f).

1) A substantial or extended decline in gold, silver, copper, zinc or lead prices

The Merged Group's business is dependent on the prices of gold, silver, copper, zinc and lead which fluctuate on a daily basis and are affected by numerous factors beyond its control. Factors tending to influence prices include:

- gold sales, purchases or leasing by governments and central banks;
- speculative short positions taken by significant investors or traders in gold, copper, silver, zinc, lead or other metals;
- the relative strength of the US dollar;
- the monetary policies employed by the world's major Central Banks;
- the fiscal policies employed by the world's major industrialised economies;
- expectations of the future rate of inflation;
- interest rates;
- recession or reduced economic activity in the United States, China, India and other industrialised or developing countries;
- decreased industrial, jewellery, base metal or investment demand;
- increased import and export taxes;
- increased supply from production, disinvestment and scrap;
- forward sales by producers in hedging or similar transactions;
- availability of cheaper substitute materials; and
- changing investor or consumer sentiment, including in connection with transition to a low-carbon economy, investor interest in crypto currencies and other investment alternatives and other factors.

8. Risks

8.2 Risks relating to the business and operations of the Merged Group *continued*

Any decline in realised commodity prices will adversely impact the Merged Group's revenues, net income and operating cash flows, particularly in light of its strategy of not engaging in hedging transactions with respect to sales of gold, silver, copper, lead or zinc.

In addition, sustained lower gold, silver, copper, zinc or lead prices can:

- reduce revenues further through production declines due to cessation of the mining of deposits, or portions of deposits, that become uneconomic at sustained lower metal prices;
- reduce or eliminate the profit that the Merged Group expects from ore stockpiles and ore on leach pads and increase the likelihood and amount that the Merged Group might be required to record write downs related to the carrying value of its stockpiles and ore on leach pads;
- halt or delay the development of new projects;
- reduce funds available for exploration and advanced projects with the result that depleted reserves may not be replaced; and
- reduce existing reserves by removing ores from reserves that can no longer be economically processed at prevailing prices.

2) Gold, silver, copper, zinc or lead reserves becoming depleted and being unable to be replaced

Mining companies must continually replace reserves depleted by production to maintain production levels over the long term and provide a return on invested capital. Depleted reserves can be replaced in several ways, including expanding known ore bodies, by locating new deposits or acquiring interests in reserves from third parties. Exploration is highly speculative in nature, involves many risks and uncertainties and is frequently unsuccessful in discovering significant mineralisation. Accordingly, the Merged Group's current or future exploration programs may not result in new mineral producing operations. Even if significant mineralisation is discovered, it will likely take many years from the initial phases of exploration until commencement of production, during which time the economic feasibility of production may change.

The Merged Group may consider, from time to time, the acquisition of ore reserves from others related to development properties and operating mines. Such acquisitions are typically based on an analysis of a variety of factors including historical operating results, estimates of and assumptions regarding the extent of ore reserves, the timing of production from such reserves and cash and other operating costs. Other factors that affect a decision to make any such acquisitions may also include the Merged Group's assumptions for future gold, silver, copper, zinc or lead prices or other mineral prices and the projected economic returns and evaluations of existing or potential liabilities associated with the property and its operations and projections of how these may change in the future. In addition, in connection with any acquisitions the Merged Group may rely on data and reports prepared by third parties (including ability to obtain permits and compliance with existing regulations) and which may contain information or data that the Merged Group is unable to independently verify or confirm. Other than historical operating results, all of these factors are uncertain and may have an impact on the Merged Group's revenue, cash flow and other operating issues, as well as contributing to the uncertainties related to the process used to estimate reserves and resources. In addition, there may be intense competition for the acquisition of attractive mining properties.

As a result of these uncertainties, the Merged Group's exploration programs and any acquisitions which the Merged Group may pursue may not result in the expansion or replacement of current production with new ore reserves or operations, which could have a material adverse effect on the Merged Group's business, prospects, results of operations and financial position.

The Merged Group's ability to sustain or increase its current level of production in the future is in part dependent on the development of new projects and the expansion of existing operations. The Merged Group will need to maintain and expand its organic growth portfolio to provide additional gold and copper production to offset production drop-off from existing operations and increase production spread. As multiple factors influence the successful delivery of new or expansion projects, including project management expertise, project planning and execution, cost control, latent technical conditions, performance of engineering partners and receipt of regulatory approvals and permits in a timely manner, the Merged Group will be exposed to a broad range of major project execution risks. For example, a delay in expansion of an existing asset could require the Merged Group to amend the existing mine plan in a way that leads to higher operating costs due to the need to mine sub-optimal grade material for longer. Impacts could be exacerbated by external factors, including higher prices for goods and services, supply chain disruptions, labour shortages or permitting delays. Failure to execute on any one or more of the major projects on time, at cost, as per the approved scope or at all may materially adversely affect its operating results and financial condition.

3) Estimates of proven and probable reserves and measured, indicated and inferred resources and the volume and grade of ore actually recovered are uncertain and may not be indicative of future results

The estimates of proven and probable reserves referred to in this Scheme Booklet (or in Newmont's or Newcrest's public filings) are subject to considerable uncertainty. Such estimates are, or will be, to a large extent, based on the prices of gold, silver, copper, zinc and lead and interpretations of geologic data obtained from drill holes and other exploration techniques, which data may not necessarily be indicative of future results. If either Newcrest or Newmont's reserve estimations are required to be revised due to significantly lower gold, silver, zinc, copper and lead prices, increases in operating costs, reductions in metallurgical recovery or other modifying factors, this could result in material write-downs of the Merged Group's investment in mining properties, goodwill and increased amortisation, reclamation and closure charges.

Producers use feasibility studies for undeveloped ore bodies to derive estimates of capital and operating costs based upon anticipated tonnage and grades of ore to be mined and processed, the predicted configuration of the ore body, expected recovery rates of metals from the ore, the costs of comparable facilities, the costs of operating and processing equipment and other factors. Actual operating and capital cost and economic returns on projects may differ significantly from original estimates. Further, it may take many years from the initial phases of exploration until commencement of production, during which time, the economic feasibility of production may change.

8.2 Risks relating to the business and operations of the Merged Group *continued*

Estimates of measured, indicated and inferred resources are subject to further exploration and development, and are, therefore, subject to considerable uncertainty. Inferred resources, in particular, have a greater amount of uncertainty as to their existence and their economic and legal feasibility. The Merged Group cannot be certain that any part or parts of the resource will ever be converted into reserves.

In addition, if the price of gold, silver, copper, zinc or lead declines from recent levels, if production costs increase, grades decline, recovery rates decrease or if applicable laws and regulations are adversely changed, the indicated level of recovery may not be realised or mineral reserves or resources might not be mined or processed profitably. If the Merged Group determines that certain of its mineral reserves have become uneconomic, this may ultimately lead to a reduction in the Merged Group's aggregate reported reserves and resources. Consequently, if the Merged Group's actual mineral reserves and resources are less than current estimates, its business, prospects, results of operations and financial position may be materially impaired.

Estimates of Newmont's reserves and resources that are disclosed in this Scheme Booklet have been prepared in accordance with Subpart 1300. In 2021, Newmont transitioned its approach to reporting and internal methodologies to take into account the required change from the SEC's Industry Guide 7 to Subpart 1300. Newmont intends for all future reserves and resource estimates released for the Merged Group's operations and projects to be prepared in accordance with Subpart 1300. To the extent that regulators adopt new requirements and issue or modify related guidance and interpretations in the future, it could result in changes to mineral reserve and mineral resource estimates and associated information.

4) Estimates relating to projects and mine plans of existing operations are uncertain and the Merged Group may incur higher costs and lower economic returns than estimated

Mine development and expansion projects typically require a number of years and significant expenditures during the development phase before production is possible and/or sustainable. Such projects could experience unexpected problems and delays during development, construction and mine start-up. A decision to develop a project is typically based on the results of studies, which estimate the anticipated economic returns of a project. The actual project profitability or economic feasibility may differ from such estimates as a result of any of the following factors, among others:

- changes in tonnage, grades and metallurgical characteristics of ore to be mined and processed;
- changes in input commodity and labour costs;
- the quality of the data on which engineering assumptions were made;
- increases in development capital and investment costs;
- adverse geotechnical conditions;
- availability of adequate and skilled labour force;
- availability, supply and cost including water, reagents, and power;
- costs related to environmental management and sales including waste management, monitoring and transport, storage of product sales, changing regulations and commitments, closure and meeting public targets on climate;
- fluctuations in inflation and currency exchange rates;
- availability and terms of financing;
- delays in obtaining environmental or other government permits or approvals or changes in the laws and regulations related to the Merged Group's operations or project development;
- changes in tax laws, the laws and/or regulations around royalties and other taxes due to regional and national governments and royalty agreements;
- government instability, including but not limited to decreased support for development of mining projects;
- weather or severe climate impacts, including, without limitation, prolonged or unexpected precipitation, drought and/or subzero temperatures;
- potential delays and restrictions in connection with health and safety issues, including pandemics (such as COVID-19 and related variants) and other infectious diseases;
- potential delays relating to social and community issues, including, without limitation, issues resulting in protests, road blockages or work stoppages; and
- potential challenges to mining activities or to permits or other approvals or delays in development and construction of projects based on claims of disturbance of cultural resources or the inability to secure consent for such disturbance.

8. Risks

8.2 Risks relating to the business and operations of the Merged Group *continued*

New projects require, among other things, the successful completion of feasibility studies, attention to various fiscal, tax and royalty matters, obtainment of, and compliance with, required governmental permits and approvals. The Merged Group may also have to identify adequate sources of water and power for new projects, ensure that appropriate community infrastructure (for example, reliable rail, ports, roads, and bridges) is developed to support the project and secure appropriate financing to fund a new project. These infrastructures and services are often provided by third parties whose operational activities will be outside of the Merged Group's control. Establishing infrastructure for development projects requires significant resources, identification of adequate sources of raw materials and supplies, and the cooperation of national and regional governments, none of which can be assured. In addition, new projects have no operating history upon which to base estimates of future financial and operating performance, including future cash flow. Thus, it is possible that actual costs may increase significantly and economic returns may differ materially from estimates. Consequently, future development activities may not result in the expansion or replacement of current production with new production, or one or more of these new production sites or facilities may be less profitable than currently anticipated or may not be profitable at all, any of which could have a material adverse effect on the Merged Group's results of operations and financial position.

Mine plans for existing operations are based on geological and metallurgical assumptions, financial projections and commodity price estimates. These estimates are periodically updated to reflect changes in operations, including modifications to proven and probable reserves and resources, revisions to environmental obligations, changes in legislation and/or political or economic environments, and other significant events associated with mining operations. Further, future positive revisions, if any, remain subject to improvements in costs, recovery, commodity price or a combination of these and other factors. Additionally, the Merged Group will review its operations for events and circumstances that could indicate that the carrying value of its long-lived assets may not be recoverable. If indicators of impairment are determined to exist at the Merged Group's mine operations, and an impairment charge is incurred, such charges are not reversible under US GAAP at a later date even when favourable modifications to proven and probable reserves and measured, indicated and inferred resources, favourable revisions to environmental obligations, favourable changes in legislation and/or political or economic environments, and other favourable events occur. As a result of these uncertainties, actual results may be less favourable than estimated returns and initial financial outlook.

5) Increased operating and capital costs could affect profitability

Costs at any particular mining location are subject to variation due to a number of factors, such as variable ore grade, changing metallurgy and revisions to mine plans in response to the physical shape and location of the ore body, as well as the age and utilisation rates for the mining and processing related facilities and equipment. In addition, costs are affected by the price and availability of input commodities, such as fuel, electricity, labour, chemical reagents, explosives, steel, concrete and mining and processing related equipment and facilities. Commodity costs are, at times, subject to volatile price movements, including increases that could make production at certain operations less profitable. Further, changes in laws and regulations can affect commodity prices, uses, and transport. Reported costs may also be affected by changes in accounting standards. A material increase in costs at any significant location could have a significant effect on profitability and operating cash flow.

The Merged Group's operational costs, including, without limitation, labour costs, can be impacted by inflation. Certain of the Merged Group's operations are located in countries that have in the past experienced high rates of inflation, such as in Argentina, Suriname, and Ghana. It is possible that in the future, high inflation in the countries in which the Merged Group operates may result in an increase in operational costs in local currencies (without a concurrent devaluation of the local currency of operations against the US dollar or an increase in the dollar price of gold, silver, copper, zinc or lead). A material increase in costs at any significant location could have a significant effect on the Merged Group's profitability and operating cash flow.

The Merged Group could have significant increases in capital and operating costs over the next several years in connection with new projects, costs related to closure reclamation activities, and in the sustaining and/or expansion of existing mining and processing operations. Costs associated with capital expenditures may increase in the future as a result of factors beyond the Merged Group's control. Increased capital expenditures may have an adverse effect on the profitability of and cash flow generated from existing operations, as well as the economic returns anticipated from new projects. Significantly higher and sustained increases in operational costs or capital expenditures could result in the deferral or closure of projects and mines in the event that costs become prohibitive.

6) Mine closure, reclamation and remediation costs for environmental liabilities may exceed the provisions that the Merged Group has made

Natural resource extractive companies are required to close their operations and rehabilitate the lands that they mine in accordance with a variety of environmental laws and regulations. Estimates of the total ultimate closure and rehabilitation costs for gold, silver, copper, zinc and lead mining operations are significant and based principally on current legal and regulatory requirements and mine closure plans that may change materially.

Additionally, the Merged Group may be held responsible for the costs of addressing contamination at the site of current or former activities or at third party sites or be held liable to third parties for exposure to hazardous substances should those be identified in the future. Under the United States Comprehensive Environmental Response, Compensation, and Liability Act of 1980 (**CERCLA**) and its state law equivalents, as well as under similar types of legislation and regulation in other applicable jurisdictions, current or former owners of properties may be held jointly and severally liable for the costs of site clean up or required to undertake remedial actions in response to unpermitted releases of hazardous substances at such property, in addition to, among other potential consequences, liability to governmental entities for the cost of damages to natural resources, which may be significant. These subject properties are referred to in the United States as "superfund" sites. It is possible that certain of the Merged Group's current or former operations, projects or exploration locations in the United States could be designated as a superfund site in the future, exposing the Merged Group to potential liability under CERCLA.

8.2 Risks relating to the business and operations of the Merged Group *continued*

The laws and regulations governing mine closure and reclamation in a particular jurisdiction are subject to review at any time and may be amended to impose additional requirements and conditions which may cause the Merged Group's provisions for environmental liabilities to be underestimated and could materially affect the Merged Group's financial position or results of operations. In addition, regulators are increasingly requesting security in the form of cash collateral, credit, trust arrangements or guarantees to secure the performance of environmental obligations, which could have an adverse effect on the Merged Group's financial position. Any underestimated or unanticipated retirement and rehabilitation costs could materially affect the Merged Group's financial position, results of operations and cash flows. Environmental liabilities are accrued when they become known, are probable and can be reasonably estimated. Whenever a previously unrecognised remediation liability becomes known, or a previously estimated reclamation cost is increased, the amount of that liability and additional cost will be recorded at that time and could materially reduce the consolidated net income attributable to the Merged Group shareholders and potentially result in impairments.

7) COVID-19 pandemic and future pandemics, epidemics and other health emergencies may affect the Merged Group's operations and business

The Merged Group faces risks related to health epidemics and other outbreaks of communicable diseases, which could significantly disrupt operations and may materially and adversely affect its business and financial conditions. The global COVID-19 pandemic has had major impacts on the world, the Merged Group's industry and the Merged Group. COVID-19 and its variants present ongoing risks and challenges, and could continue to impact the Merged Group's people, operations and surrounding communities. Efforts to control the spread of COVID-19 impacted the operation of the Merged Group's mines and the development of projects and exploration activities and may continue to do so in the future. The governments in many of the jurisdictions in which the Merged Group will operate implemented restrictive measures such as travel bans, quarantine and self-isolation at various times during the pandemic and may do so again in the future. The scope and duration of any such restrictions remains outside of the Merged Group's control. The Merged Group will carefully consider government restrictions and the needs of its employees and host communities. Additionally, based upon evolving contagion rates or occurrences at operating sites, senior management or the Merged Group's Board may be required to or decide to reduce or limit operational activities to essential care and maintenance procedures including the management of critical environmental systems. Reductions in the Merged Group's operational activities due to COVID-19, or another pandemic, epidemic or health outbreak, could result in additional sites being placed into care and maintenance for extended periods of time and/or have a material adverse impact on the Merged Group's business, or financial condition, results of operations and cash flows. If the majority of Merged Group sites are placed into care and maintenance, this could significantly reduce cash flow and impact the Merged Group's ability to meet certain covenants related to its revolving credit facility and borrowing capacity.

The Merged Group could continue to incur costs as a result of actions taken to protect against the impacts of the COVID-19 pandemic and to comply with local mandates, including but not limited to additional health screenings, incremental travel, security and employee-related costs. Other impacts of changing government restrictions and the evolving health environment in connection with pandemics, epidemics or health outbreaks and emergencies could include prolonged travel restraints, more stringent shipment restraints, delays in product refining and smelting due to restrictions or temporary closures, other supply chain disruptions and workforce interruptions, including loss of life, and reputational damage in connection with challenges or reactions to action or perceived inaction by the Merged Group, which could have a material adverse effect on the Merged Group cash flows, earnings, results of operations and financial position.

8) Damage to the Merged Group's reputation resulting in decreased investor confidence, damaged community relations and additional obstacles to developing projects

Damage to the Merged Group's reputation can be the result of the actual or perceived occurrence of a variety of events and circumstances, and could result in negative publicity (for example, with respect to handling of environmental, employee, safety and security matters, dealings with local community organisations or individuals, community commitments, handling of cultural sites or resources, human rights and various other matters).

Newmont has provided, and the Merged Group will provide, greater transparency on environmental, social and governance performance in response to stakeholder engagement and requests in recent years, along with supplemental disclosures in an 'Annual Sustainability Report', an annual 'Climate Report' and other sustainability reports in connection with stakeholder concerns and issues. Such increased transparency may result in greater scrutiny and impact how the Merged Group is perceived.

The growing use of social media to generate, publish and discuss community news and issues and to connect with others has made it significantly easier, among other things, for individuals and groups to share their opinions of the Merged Group and its activities, whether true or not. The Merged Group will not have direct control over how it is perceived by others and any resulting loss of reputation could have a material adverse effect on the Merged Group's business, financial position and results of operations.

9) The Merged Group may experience problems in managing new acquisitions and integrating them with its existing operations, together with risks associated with divestments

The Merged Group's ability to execute acquisitions and challenges or delays in achieving the successful integration of any such acquisitions could have an adverse effect on its operating results and financial condition. The Merged Group may also be liable for the acts or omissions of predecessors, or otherwise be exposed to liabilities that are unforeseen or greater than anticipated.

The Merged Group may have ongoing exposures to divested businesses or assets, including through the provision of continued services and infrastructure or an agreement to retain certain liabilities of the divested businesses or assets through warranties and indemnities, which may have a materially adverse impact on the Merged Group's operating results and financial condition.

8. Risks

8.2 Risks relating to the business and operations of the Merged Group *continued*

10) Being dependent on information technology and operational technology systems which are subject to disruption, damage, failure and risks associated with implementation of the Scheme, upgrade, operations and integration

The Merged Group is dependent upon information technology and operational technology systems. The operating and control systems at Merged Group mines increasingly leverage technology-based solutions based on a combination of on-premises and cloud-based platforms. These systems are crucial for operating Merged Group mines safely and efficiently. The Merged Group's systems, and those of third-party service providers and vendors, may be targeted by increasingly sophisticated threat actors. These threats include continually evolving cybersecurity risks from a variety of sources, including, without limitation, malware, computer viruses, cyber threats, extortion, employee error, malfeasance, security breaches, cyberattacks, natural disasters and defects in design. Cybersecurity risk is increasingly difficult to identify and quantify and cannot be fully mitigated because of the rapidly evolving nature of the threats, and the increasing sophistication of the threat actors. Additionally, unauthorised parties may attempt to gain access to these systems for Merged Group information through fraud or other means of deceiving the Merged Group's third-party service providers, employees or vendors. Newmont and Newcrest have previously experienced attempts by external parties to compromise its networks and systems.

Given the unpredictability of the timing, nature and scope of information technology disruptions, the Merged Group could potentially be subject to production downtimes, operational delays, the compromising of confidential or otherwise protected information, destruction or corruption of data, security breaches, other manipulation or improper use of the Merged Group's systems and networks or financial losses from remedial actions. Outages in the Merged Group's operational technology may affect operations related to health and safety and could result in putting lives at risk of harm or death. In addition, as technologies evolve and cybersecurity attacks become more sophisticated, the Merged Group may incur significant costs to upgrade or enhance its security measures to protect against such attacks and may face difficulties in fully anticipating or implementing adequate preventive measures or mitigating potential harm. Such efforts may prove insufficient to deter future cybersecurity attacks or prevent all security breaches.

11) Interests in current or future joint ventures are subject to the risks normally associated with the conduct of joint ventures

To the extent the Merged Group holds or acquires interests in any joint ventures or enters into any joint ventures in the future, the existence or occurrence of one or more of the following circumstances and events could have a material adverse impact on the Merged Group's profitability or the viability of its interests held through joint ventures, which could have a material adverse impact on the Merged Group's future cash flows, earnings, results of operations and financial condition:

- inconsistent economic, political or business interests or goals between joint venture partners or disagreements with joint venture partners on strategy for the most efficient development or operation of mines;
- inability to control certain strategic decisions made in respect of properties;
- exercise of majority rights by joint venture partners so as to take actions for which the Merged Group may not believe to be in the joint venture's best interests, including but not limited to decisions related to day to day operations, labour relations, litigation, government relations, political contributions, community relations, project approval and project funding mechanisms;
- inability of joint venture partners to meet their financial and other obligations to the joint venture or third parties; and
- litigation between joint venture partners regarding management, funding or other decisions related to the joint venture.

To the extent that the Merged Group is not the operator of a joint venture property, such that it will be unable to control the activities of the operator, the success of such operations will be beyond the Merged Group's control. In many cases the Merged Group will be bound by the decisions made by the operator in the operation of such property, and will rely on the operator to manage the property and to provide accurate information related to such property. The Merged Group can provide no assurance that all decisions of operators of properties it does not control will achieve the expected results. Further, operators of a joint venture property may take decisions that may result in circumstances that have a material adverse impact on the reputation and relationship with stakeholders and communities of the Merged Group.

Additionally, the Merged Group is subject to certain funding requirements in connection with its joint ventures. Joint venture funding requirements, as well as the ability of partners to meet their financial and other obligations, may result in increases to the Merged Group's costs and required capital expenditures.

g) Financial risks

The Merged Group and its businesses, and the industries in which they operate, are subject to a number of financial risks, including risks that are outside of the Merged Group's control, which could negatively impact on the Merged Group's actual operational or financial results. A non-exhaustive summary of these risks is set out in this section 8.2(g).

1) Increased exposure to foreign exchange fluctuations and capital controls may adversely affect the Merged Group's earnings and the value of the Merged Group's assets

The Merged Group's reporting currency will be the US dollar and the majority of its earnings and cash flows will be denominated in US dollars. The operations of Newcrest are also conducted in US dollars, but Newcrest conducts some of its business in currencies other than the US dollar. As a result, following implementation of the Scheme, the Merged Group's consolidated earnings and cash flows may also be impacted by movements in the exchange rates to a greater extent than prior to the Scheme. In particular, any change in the value of the currencies of the Australian Dollar, Canadian Dollar, the Papua New Guinean Kina, the Chilean Peso or the Fijian Dollar versus the US dollar could negatively impact the Merged Group's ability to realise all of the anticipated benefits of the Scheme.

8.2 Risks relating to the business and operations of the Merged Group *continued*

In addition, from time to time, emerging market countries such as those in which the Merged Group will operate adopt measures to restrict the availability of the local currency or the repatriation of capital across borders. These measures are imposed by governments or central banks, in some cases during times of economic instability, to prevent the removal of capital or the sudden devaluation of local currencies or to maintain in-country foreign currency reserves. In addition, many emerging market countries require consents or reporting processes before local currency earnings can be converted into US dollars or other currencies and/or such earnings can be repatriated or otherwise transferred outside of the operating jurisdiction. These measures may have a number of negative effects on the Merged Group, including reducing the immediately available capital that the Merged Group could otherwise deploy for investment opportunities or the payment of expenses.

In addition, measures that restrict the availability of the local currency or impose a requirement to operate in the local currency may create other practical difficulties for the Merged Group.

In particular, PNG is currently experiencing a backlog by foreign and domestic companies and governmental agencies to convert Kina into foreign currencies, particularly in the US dollar. Revenue generation and profitability in respect of foreign exchange transactions are dependent on volumes and margins, which are subject to volatility and regulatory intervention by the Bank of Papua New Guinea. There is a risk that continued volatility, and further changes in applicable regulations or policy, may adversely impact future revenue and profitability.

There have also been talks of devaluation of the Kina which, if implemented, may also negatively impact the Merged Group's ability to realise some of the anticipated benefits of the Scheme.

See also risks set out in sections 8.2(i)(4), 8.2(i)(5) and 8.2(i)(6).

2) Future funding requirements may affect the Merged Group's business, ability to pursue business opportunities, invest in existing and new projects, pay cash dividends or engage in share repurchase transactions

Potential future investments, including projects in the Merged Group's project pipeline, acquisitions and other investments, will require significant funds for capital expenditures. Depending on gold, silver, copper, zinc and lead prices, the Merged Group's operating cash flow may not be sufficient to meet all of these expenditures, depending on the timing of development of these and other projects. As a result, new sources of capital may be needed to meet the funding requirements of these investments, fund ongoing business activities, and fund construction and operation of potential future projects. The Merged Group's ability to raise and service significant new sources of capital will be a function of macroeconomic conditions, future gold, silver, copper, zinc and lead prices as well as the Merged Group's operational performance, current cash flow and debt position, among other factors. The Merged Group may determine that it may be necessary or preferable to issue additional equity or other securities, defer projects or sell assets. However, United States and global markets have, from time to time, experienced significant dislocations and liquidity disruptions. For example, the COVID-19 pandemic and events related to the conflict and related sanctions in Ukraine, Russia and/or Belarus increased, and may continue to increase, volatility and pricing in the capital markets. Additional financing may not be commercially available when needed or, if available, the terms of such financing may not be favourable to the Merged Group and, if raised by offering equity securities, any additional financing may involve substantial dilution to existing shareholders. In the event of lower gold, silver, copper, zinc or lead prices, unanticipated operating or financial challenges, or new funding limitations, the Merged Group's ability to pursue new business opportunities, invest in existing and new projects, fund ongoing business activities, retire or service all outstanding debt, fund share repurchase programs and transactions and pay dividends could be significantly constrained.

In addition, the Merged Group's joint venture partners may not have sufficient funds or borrowing ability in order to make their capital commitments. In the case that the Merged Group's joint venture partners do not make their economic commitments, the Merged Group may be prevented from pursuing certain development opportunities or may assume additional financial obligations, which may require new sources of capital.

3) The Merged Group's long-lived assets and goodwill could become impaired

If indicators of impairment are determined to exist at the Merged Group's mine operations, the Merged Group will review the recoverability of the carrying value of long-lived assets by estimating the future undiscounted cash flows expected to result from the use and eventual disposition of the asset. The Merged Group will also review the goodwill for impairment annually and when events or changes in circumstances indicate that the carrying value of a reporting unit exceeds its fair value. The Merged Group management will make multiple assumptions in estimating future cash flows, which include production levels based on life of mine plans, future costs of production, estimates of future production levels based on value beyond proven and probable reserves at the Merged Group's operations, prices of metals, the historical experience of the Merged Group's operations and other factors. There are numerous uncertainties inherent in estimating production levels of gold, silver, copper, zinc and lead and the costs to mine recoverable reserves, including many factors beyond the Merged Group's control that could cause actual results to differ materially from expected financial and operating results or result in future impairment charges. The Merged Group may be required to recognise material non-cash charges relating to impairments of long-lived assets and/or goodwill in the future if actual results differ materially from the Merged Group management's estimates, which include metal prices, the Merged Group's ability to reduce or control production costs or capital costs through strategic mine optimisation initiatives, increased costs or decreased production due to regulatory issues or if the Merged Group does not realise the mineable reserves, resources or exploration potential at its mining properties. Additions to asset retirement costs also could result in impairment charges.

8. Risks

8.2 Risks relating to the business and operations of the Merged Group *continued*

The Merged Group will evaluate strategic priorities and deployment of capital to projects in the pipeline. A decision to reprioritise, sell or abandon a development project could result in a future impairment charge.

If an impairment charge is incurred, such charges are not reversible under US GAAP at a later date even when favourable modifications to the Merged Group's proven and probable reserves and measured, indicated and inferred resources, favourable revisions to environmental obligations, favourable changes in legislation and/or the Merged Group's political or economic environment, or other favourable events occur. As a result of these uncertainties, the Merged Group's operating results may be significantly impacted from both the impairment and the underlying trends in the business that triggered the impairment, and actual results may be less favourable than estimated returns and initial financial outlook.

4) The Merged Group's ability to recognise the benefits of deferred tax assets is dependent on future cash flows and taxable income

The Merged Group will recognise the expected future tax benefit from deferred tax assets when the tax benefit is considered to be more likely than not of being realised, otherwise, a valuation allowance is applied against deferred tax assets under US GAAP. Assessing the recoverability of deferred tax assets will require the Merged Group management to make significant estimates related to expectations of future taxable income. Estimates of future taxable income are based on historical results of operations, forecasted cash flows from operations, and the application of existing tax laws in each jurisdiction. To the extent that future cash flows and taxable income differ significantly from estimates, the Merged Group's ability to realise the deferred tax assets could be impacted. In the future, the Merged Group's estimates could change requiring a valuation allowance or impairment of the Merged Group's deferred tax assets. Additionally, future changes in tax laws could limit the Merged Group's ability to obtain the future tax benefits represented by the Merged Group's deferred tax assets.

5) Downgrades in the credit ratings assigned to the Merged Group's debt securities could increase the Merged Group's future borrowing costs and adversely affect the availability of new financing

There can be no assurance that any rating currently assigned by Standard & Poor's Rating Services or Moody's Investors Service to Newcrest or Newmont, or which will be assigned to the Merged Group, will remain unchanged for any given period of time or that a rating will not be lowered if, in that rating agency's judgment, future circumstances relating to the basis of the rating so warrant. If the Merged Group is unable to maintain its outstanding debt and financial ratios at levels acceptable to the credit rating agencies, or should the Merged Group's business prospects or financial results deteriorate, the Merged Group's ratings could be downgraded by the rating agencies. Newcrest and Newmont's credit ratings have been subject to change over the years. A downgrade by the rating agencies could adversely affect the value of Merged Group securities, Newmont's existing debt and the ability of the Merged Group to obtain new financing on favourable terms, if at all, and increase borrowing costs, which in turn could impair the results of the Merged Group's operations and financial position.

6) Uncertain returns for investments in pension plans maintained for certain employees which provide for specified payments after retirement

Newmont maintains pension plans for certain employees which provide for specified payments after retirement. Newmont's qualified pension plans are funded with cash contributions in compliance with United States regulatory requirements. Newmont's non-qualified and other benefit plans are currently not funded, but exist as general corporate obligations.

The Merged Group will review its retirement benefit programs on a regular basis and will consider market conditions and the funded status of its qualified pension plans in determining whether additional contributions are appropriate. The ability of the pension plans described above to provide the specified benefits depends on the Merged Group funding the plans and returns on investments made by the plans. Returns, if any, on investments are subject to fluctuations based on investment choices and market conditions. A sustained period of low returns or losses on investments could require the Merged Group to fund the pension plans to a greater extent than anticipated. If future plan investment returns are not sufficient, the Merged Group may be required to increase the amount of future cash contributions.

8.2 Risks relating to the business and operations of the Merged Group *continued*

h) Industry risks

The Merged Group will operate in mining and extractive industries which are subject to a number of industry-specific risks, including risks that are outside of its control, which could negatively impact on the Merged Group's actual operational and financial results. A non-exhaustive summary of these risks is set out in this section 8.2(h).

1) Increased costs or losses resulting from the hazards and uncertainties associated with mining

The exploration for natural resources and the development and production of mining operations are activities that involve a high level of uncertainty. These can be difficult to predict and are often affected by risks and hazards which will be outside of the Merged Group's control. These factors include, but are not limited to:

- environmental hazards, including discharge of metals, concentrates, pollutants or hazardous chemicals;
- industrial accidents, including in connection with the operation of mining equipment, milling equipment and/or conveyor systems and accidents associated with the preparation and ignition of large-scale blasting operations, milling and processing;
- accidents in connection with transportation, including transportation of chemicals, explosions or other materials, transportation of large mining equipment and transportation of employees and business partners to and from sites;
- social, community or labour force disputes resulting in work stoppages or shipping delays or related loss of social acceptance of community support;
- changes and/or increasingly stringent legal and regulatory requirements;
- delays in permitting due to regulator or community concerns, or reduced resources and capacity for review and formulation of permits at regulatory agencies;
- security incidents, including activities of illegal or artisanal miners, gold bullion or concentrate theft, including in transport, and corruption and fraud;
- shortages in materials or equipment and energy and electrical power supply interruptions or rationing;
- failure of unproven or evolving technologies or loss of information integrity or data;
- unexpected geological formations or conditions (whether in mineral or gaseous form);
- metallurgical conditions and gold, silver, copper, lead, zinc and other metal recovery, including unexpected decline of ore grade;
- unanticipated changes in inventory levels at heap-leach operations;
- ground and surface water conditions;
- seismic activity and fall-of-ground accidents in underground operations;
- failure of mining pit slopes and tailings dam walls;
- earthquake and other similar natural phenomena;
- surface or underground fires or floods; and
- other natural phenomena, such as lightning, cyclonic or tropical storms, floods or other inclement weather conditions, including those impacting operations or the ability to access and supply sites.

The occurrence of one or more of these events in connection with the Merged Group's exploration activities, development and production and closure of mining operations may result in the death of, or personal injury to, the Merged Group's employees, other personnel or third parties, the loss of mining equipment, damage to or destruction of mineral properties or production facilities, monetary losses, deferral or unanticipated fluctuations in production, environmental damage and potential legal liabilities, all of which may adversely affect the Merged Group's reputation, business, prospects, results of operations and financial position.

2) Competition with other natural resource companies and shortages of critical parts and equipment

The Merged Group will compete with other natural resource companies for specialised equipment and supplies necessary for exploration and development, as well as for rights to mine properties containing gold, silver, copper, zinc, lead and other minerals. The mining industry has been impacted, from time to time, by increased demand for critical resources such as input commodities, drilling equipment, trucks, shovels and tires. These shortages can impact the efficiency of mining operations and result in cost increases and delays in construction of projects; thereby impacting operating costs, capital expenditures and production and construction schedules. The Merged Group may be unable to obtain the services of skilled personnel and contractors or specialised equipment or supplies, or to acquire additional rights to mine properties, which could have an adverse effect on the Merged Group's competitive position or adversely impact the Merged Group's results of operations.

8. Risks

8.2 Risks relating to the business and operations of the Merged Group *continued*

3) Merged Group's ability to obtain or retain necessary permits and leases

The Merged Group's mining and processing operations and development and exploration activities are subject to extensive permitting requirements. The requirements to obtain and/or achieve or maintain full compliance with such permits can be costly and involve extended timelines. The Merged Group will strive to obtain and comply with all required permits, however there can be no assurance that the Merged Group will obtain all such permits and/or achieve or maintain full compliance with such permits at all times. Previously obtained permits may be suspended or revoked for a number of reasons, including through government or court action. Failure to obtain and/or comply with required permits can have serious consequences, including damage to the Merged Group's reputation, cessation of the development of a project, increased costs of development or production and litigation or regulatory action, any of which could materially adversely affect the Merged Group's business, results of operations or financial condition.

The Merged Group's ability to obtain the required permits and approvals to explore for, develop and operate mines and to successfully operate near communities in the jurisdictions in which it operates depends in part on the Merged Group's ability to develop, operate and close mines in a manner that is consistent with the creation of social and economic benefits in the surrounding communities, which may or may not be required by law. The Merged Group's ability to obtain permits and approvals and to operate near certain communities may be adversely impacted by real or perceived detrimental events associated with Merged Group's activities or those of other mining companies affecting the environment, health and safety of communities in which it operates. Key permits and approvals may be revoked or suspended or may be adjusted in a manner that adversely affects the Merged Group's operations, including its ability to explore or develop properties, commence production or continue operations. Permit review and approval could be delayed, adversely impacting project implementation due to delays in review and development of permits from limited resources at the regulatory agencies.

Certain of the Merged Group's mining and processing operations, including tailings storage, and project expansion and development activities require the lease of land, rights and properties. Obtaining and/or maintaining and renewing lease arrangements can be costly, and no assurance can be provided that all necessary lease arrangements and renewals will be achieved or maintained at all times. For example, the Boddington operation is primarily located on mining leases with renewal dates commencing in 2028 and no assurances can be provided that such renewals and additional lease scope for further tailings capacity will be secured at similar cost or at all. Failure to obtain necessary leases can have serious consequences, including cessation of operations and processing or the development of a project and/or increased costs, litigation or regulatory action, any of which could materially adversely affect the Merged Group's business, results of operations or financial condition.

See also risks set out in sections 8.2(h)(11) and 8.2(k)(2).

4) Increasing requirements for mining companies to consider and provide benefits to the communities and countries in which they operate in order to maintain operations

Greater scrutiny on the private sector broadly and multi-national companies specifically, to contribute to sustainable outcomes in the places where they operate, has led to a proliferation of standards and reporting initiatives focused on environmental stewardship, social performance and transparency. Extractive industries, and mining in particular, have seen significant increases in stakeholder expectations. These businesses are increasingly required to meaningfully engage with impacted stakeholders, understand and avoid or mitigate negative impacts while optimising economic development and employment opportunities associated with their operations. The expectation is for companies to create shared value for shareholders, employees, governments, local communities and host countries. Such expectations tend to be particularly focused on companies whose activities are perceived to have high socio-economic and environmental impacts. In response, Newmont has developed, and the Merged Group will continue to evolve, a robust system of ESG management that includes standards, guidance, assurance, participation in international organisations focused on improved performance and outcomes for host communities and the environment.

Despite the Merged Group's commitment to ongoing engagement with communities and stakeholders, no assurances can be provided that increased stakeholder expectations will not result in adverse financial and operational impacts to the business, including, without limitation, project development or operational disruption, increased costs, increased investment obligations and increased taxes and royalties payable to governments.

5) Illegal mining and artisanal mining occurs on or adjacent to certain Merged Group properties and exposes those sites to security risks

Artisanal and illegal miners have been active on, or adjacent to, some of Newmont's African and South American properties, including in Suriname and Ghana in recent years. For example, in Ghana in 2019, illegal miners attacked a field team of security guards employed by a security contractor, tragically resulting in a fatality. Illegal mining, which involves trespass into the development or operating area of the mine, is both a security and safety issue, which may present a security threat to property and human life. The illegal miners from time to time have clashed with security staff and law enforcement personnel who have attempted to move them away from the facilities. Although, under certain circumstances, artisanal mining may be a legally sanctioned activity, artisanal mining is also associated with a number of negative impacts, including environmental degradation, poor working practices, erosion of civil society, human rights abuses and funding of conflict. The environmental, social, safety and health impacts of artisanal and illegal mining are frequently attributed to formal large scale mining activity, and it is often assumed that artisanally-mined gold is channelled through large-scale mining operators, even though artisanal and large-scale miners normally have separate and distinct supply chains. These misconceptions impact negatively on the reputation of the industry. The activities of the illegal miners could cause damage to the Merged Group's properties or result in inappropriate or unlawful use of force for which the Merged Group could potentially be held responsible. The presence of illegal miners could lead to exploration and project delays and disputes regarding the development or operation of commercial gold deposits. Illegal mining and theft could also result in lost gold production and reserves, mine and development stoppages, and have a material adverse effect on financial condition or results of operations or project development.

8.2 Risks relating to the business and operations of the Merged Group *continued*

6) Civil disturbances and criminal activities can disrupt business and expose the Merged Group to liability

Civil disturbances and criminal activities such as trespass, illegal mining, sabotage, theft, blockades, organised crime and vandalism may cause disruptions and could result in the suspension of operations, delays to project development and negative impacts on exploration activities at certain sites. Additionally, some areas in which the Merged Group conducts operations and develops projects and exploration activities are affected by persistent violence and organised crime involving significant drug cartels, such as in Mexico.

Although security measures have been implemented by each of Newmont and Newcrest to protect employees, community members, property and assets, such measures will not guarantee that such civil disturbances and criminal activities will not continue to occur in the future, or result in harm to the Merged Group's employees, community members or trespassers, decrease operational efficiency or construction delays, increase community tensions or result in liabilities or reputational harm to the Merged Group. Security incidents, in the future, may have a material adverse effect on the Merged Group's operations, development projects, exploration and reclamation activities, especially if criminal activity and violence continue to escalate. Such incidents may halt or delay production, increase operating costs, result in harm to employees, contractors, visitors or community members, decrease operational efficiency due to employee absenteeism and other factors, increase community tensions or otherwise adversely affect the Merged Group's ability to conduct business. The manner in which the Merged Group's personnel, national police or other security forces respond to civil disturbances and criminal activities can give rise to additional risks where those responses are not conducted in a manner consistent with international and Merged Group standards relating to the use of force and respect for human rights. Although each of Newmont and Newcrest have implemented a number of significant measures and safeguards which are intended to ensure that personnel understand and uphold these standards, the implementation of these measures will not guarantee that personnel, national police or other security forces will uphold these standards in every instance. The evolving expectations related to human rights, Indigenous rights, and environmental protections may result in opposition to the Merged Group's current and future operations, the development of new projects and mines, and exploration activities. Such opposition may take the form of legal or administrative proceedings or manifestations such as protests, roadblocks or other forms of public expression against the Merged Group's activities, and may have a negative impact on the Merged Group's local or global reputation and operations. Opposition by community and activist groups to the Merged Group's operations may require modification of, or preclude the operation or development of, the Merged Group's projects and mines or may require the Merged Group to enter into agreements with such groups or local governments with respect to the Merged Group's projects and mines or exploration activities, in some cases, causing increased costs and significant delays to the advancement of the Merged Group's projects. The failure to conduct operations in accordance with the Merged Group's standards may result in harm to employees, community members or trespassers, increase community tensions, reputational harm to the Merged Group or result in criminal and/or civil liability and/or financial damages or penalties.

7) Substantial regulation of health and safety

The Merged Group's operations are subject to extensive and complex laws and regulations governing worker health and safety across its operating regions and failure to comply with applicable legal requirements can result in substantial penalties. Future changes in applicable laws, regulations, permits and approvals or changes in their enforcement or regulatory interpretation could substantially increase costs to achieve compliance, lead to the revocation of existing or future exploration or mining rights or otherwise have an adverse impact on the Merged Group's results of operations and financial position.

The Merged Group's mines are inspected on a regular basis by government regulators who may issue citations and orders when they believe a violation has occurred under local mining regulations. If inspections result in an alleged violation, the Merged Group may be subject to fines, penalties or sanctions and the Merged Group's mining operations could be subject to temporary or extended closures.

In addition to potential government restrictions and regulatory fines, penalties or sanctions, the Merged Group's ability to operate (including the effect of any impact on the Merged Group's workforce) and thus, the Merged Group's results of operations and financial position (including because of potential related fines and sanctions), could be adversely affected by accidents, injuries, fatalities or events detrimental (or perceived to be detrimental) to the health and safety of the Merged Group's employees, the environment or the communities in which the Merged Group operates.

8) Extensive environmental laws and regulations

The Merged Group's exploration, development, mining and processing operations, and closed facilities are subject to extensive laws and regulations governing land use and the protection of the environment, which generally apply to air and water, protection of endangered, protected or other specified species, hazardous and non-hazardous waste management and reclamation. Many of the countries in which the Merged Group operates have laws and regulations related to water (quality and quantity), nature and greenhouse gas (GHG) emissions which are becoming increasingly more stringent. Newmont has made, and the Merged Group expects to make in the future, significant expenditures to comply with such laws and regulations. Compliance with these laws and regulations imposes substantial costs and burdens, and can cause delays in obtaining, failure to obtain or renew, or cancellation of, government permits and approvals which may adversely impact the Merged Group's project developments, operations and closure processes. Increased global attention or regulation on consumption of shared resources and use products or development of waste that have the potential to impact human health and the environment could similarly have an adverse impact on the Merged Group's results of operations and financial position due to increased compliance and input costs.

8. Risks

8.2 Risks relating to the business and operations of the Merged Group *continued*

9) Risks related to transitioning the business to meet regulatory, societal and investor expectations for operating in a low carbon economy

Climate change and the transition to a low-carbon economy is expected to impact the Merged Group in a number of ways. Producing gold, silver, copper, zinc, lead and other minerals is an energy-intensive business, currently resulting in a significant carbon footprint. Transitioning to a lower-carbon economy will require significant investment and may entail extensive policy, legal, technology, and market changes to address mitigation and adaptation requirements related to climate change. Depending on the nature, speed, focus and jurisdiction of these changes, transition risks may pose varying levels of financial and reputational risk to the business.

A number of governments or governmental bodies have introduced or are contemplating regulatory changes in response to the potential impacts of climate change that are viewed as the result of emissions from the combustion of carbon-based fuels. At the 21st Conference of the Parties of the United Nations Framework Convention on Climate Change (**UNFCCC**) held in Paris in 2015, the Paris Agreement was adopted which was intended to govern emission reductions beyond 2020. Newmont supports the UNFCCC goal of limiting global warming to “well below 2°C” compared to pre-industrial levels and plans to transition its operations to meet this goal by 2030, with an aspiration of carbon neutrality by 2050. In 2020, Newmont also announced plans to significantly invest in climate change initiatives in support of this goal, and additional material investments and capital expenditures will be required in order to meet the Merged Group's climate targets in the future. Inconsistent implementation or significant delay in the implementation of country-level policy related to the Paris Agreement and enhanced framework objectives announced at the most recent annual UN Climate Change Conference of the Parties (**COP27**) in November 2022 are likely to increase the risk for future regulatory impacts and rapid shifts to low-carbon technologies.

Policy and regulatory risk related to actual and proposed changes in climate- and water-related laws, regulations and taxes developed to regulate the transition to a low-carbon economy may result in increased costs for the Merged Group's operations, venture partners and suppliers, including increased energy, capital equipment, environmental monitoring and reporting and other costs to comply with such regulations. Regulatory uncertainty may incur higher costs and lower economic returns than originally estimated for new development projects and operations, including closure reclamation obligations. For example, operational and capital expenses are expected to increase in order to meet renewable portfolio standard requirements by 50% or greater from current costs over the next 10 years in Australia, Canada, Mexico and the United States. Carbon taxes, fuel switching and the transition to cleaner purchased power and/or on-site renewable energy generation will require significant upfront capital expenditures and may also increase operating costs. As another example, the carbon tax in Canada of C\$30/tonne of CO₂ increased to C\$50/tonne in 2022 may impact operating costs at the Merged Group's Canadian operations. The Merged Group expects the potential for similar tax increases in other jurisdictions. Additionally, the Merged Group does not maintain insurance policies against such climate-related risks or taxes.

The development and deployment of technological improvements or innovations will be required to support the transition to a low-carbon economy, which could result in write-offs and early retirement of existing assets, increased costs to adopt and deploy new practices and processing including planning and design for mines, development of alternative power sources, site level efficiencies and other capital investments. The Merged Group is also considering the limited use of carbon offsets to support meeting its 2050 carbon neutral goal by neutralising hard to abate residual emissions.

There will be varied and complex market impacts due to climate change and the transition to a low-carbon economy. There will be shifts in supply and demand for certain commodities, products and services in connection with evolving consumer and investor sentiments. Market perceptions of the mining sector, and, in particular, the role that certain metals will or will not play in the transition to a low-carbon economy remains uncertain. Potential financial impacts may include reduced investment in gold due to shift in investor sentiment, increased production costs due to changing input prices, re-pricing of land valuation and assets, increased global competition for key materials needed for new technologies (for example, lithium, copper and rare earth minerals used in solar technology), potential cost increases by insurers and lenders, and potential increases in taxation of the mining and metals sector.

Should the mining and metals sector not respond quickly enough to meeting globally accepted science-based reductions required to mitigate the long-term impacts of climate change, industry members may be subject to an increased risk of future climate litigation. In the United States and Canada, lawsuits have been filed against oil and gas companies to assign liability for climate-related impacts. Over time, litigation may also apply to other resource intensive sectors that fail to set and/or meet long-term reduction targets. While the Merged Group is not currently subject to any lawsuits related to climate, no assurances can be provided that similar suits will not be brought in the future.

The Merged Group's failure to meet its climate strategy commitments and/or societal or investor expectations could also result in damage to the Merged Group's reputation, decreased investor confidence and challenges in maintaining positive community relations, which can pose additional obstacles to the Merged Group's ability to conduct its operations and develop its projects, which may result in a material adverse impact on the Merged Group's business, financial position, results of operations and growth prospects. Further, the Merged Group's financing strategy will be tied to its ESG commitments. The interest rate of Newmont's \$1 billion aggregate principal amount of 2.6% Sustainability-Linked Senior Notes due 2032 (**Notes**) is linked to Newmont's performance against key ESG commitments regarding 2030 emissions reduction targets and the representation of women in senior leadership roles target. The interest rate margin of Newmont's \$3 billion sustainability-linked revolving credit facility is also subject to adjustment based on Newmont's ESG scores. As such, a failure to meet Newmont's climate and sustainability targets can result in further expense and impact the Merged Group's liquidity and financial condition.

8.2 Risks relating to the business and operations of the Merged Group *continued*

Newmont's targets are uniquely tailored to its business, operations and capabilities, which do not easily lend to benchmarking against similar sustainability performance targets, and the related performance, of other companies. The Merged Group will review its targets and sustainability framework from time to time, which may result in amendments in the future. The Merged Group may choose to adopt more ambitious targets in the future in connection with evolving best practices and market demand, which may be increasingly challenging and costly to achieve. Additionally, the methodologies that the Merged Group uses to calculate its Scope 1, Scope 2 and Scope 3 GHG emissions may change over time based upon changing industry standards, which may impact, positively or negatively, its ability to satisfy its targets, which could in turn adversely affect its reputation. Any major acquisition, merger, consolidation or divestiture or any series of related acquisitions, mergers, consolidations or divestitures by or involving the Merged Group may impact its ability to achieve its targets and commitments. There is currently no generally accepted global definition (legal, regulatory or otherwise) of, nor market consensus as to what criteria qualify as, "green," "social," "sustainable" or "sustainability-linked" (and, in addition, the requirements of any such label may evolve from time to time), and therefore no assurance is or can be given that the Merged Group will meet any or all investor expectations.

10) Transitional and physical risks related to climate change

Climate change has the potential to impact the regions and sites in which the Merged Group operates, as well as the surrounding communities. Long-term potential physical climate risks include, but are not limited to, higher temperature in all regions, higher intensity storm events in all regions, impacts to annual precipitation depending upon the latitude and proximity of the site to oceans, and more extreme heat for sites near the equator or in Australia.

Physical risks related to extreme weather events such as extreme precipitation, flooding, longer wet or dry seasons, increased temperatures and drought, landslides, wildfires or brushfires, or more severe storms may have financial implications for the Merged Group business. For example, severe flooding occurred in early 2017 at Newmont's Tanami mine in Australia which led to shutdown of operations for several weeks. In 2019, Tanami completed the construction of a natural gas pipeline to deliver fuel to the site to replace diesel fuel that is trucked to the site on roads that regularly flood due to increasing seasonal rainfall. The Merged Group's operations in Suriname and Peru have also experienced delays in the connection with the delivery of key production supplies due to temporary flooding. There is also the potential for disruption to transport routes (for example, road or rail) associated with the distribution of Merged Group products. Severe storm events can also result in unpermitted off-site discharges, mine pit slope instability, mine pit erosion and structural failures, tailings storage facility overtopping and other impacts, including water storage and treatment facility capacity considerations. Extended dry seasons or unseasonal dry conditions could exacerbate dust generation from operating activities that may require additional controls for continued operation or result in compliance breaches. Changing climatic conditions may also affect the likelihood of meeting closure success criteria and require adjustments to mine site rehabilitation and closure plans. The higher potential for extreme heat conditions may affect equipment efficiency.

Such events can temporarily slow or halt operations due to physical damage to assets, reduced worker productivity for safety protocols on site related to extreme temperatures or lightening events, disruption to worker aviation and bus transport to or from the site, and local or global supply route disruptions that may limit transport of essential materials, chemicals and supplies, and products which could have an adverse impact on the Merged Group's project developments, operations and financial position. Additional financial impacts could include increased capital or operating costs to increase water storage and treatment capacity, obtain or develop maintenance and monitoring technologies, increase resiliency of facilities and establish supplier climate resiliency and contingency plans.

An increase in frequency and duration of extreme weather conditions can be followed by extended power outages. Energy disruptions can have an adverse impact on the Merged Group's results of operations and financial position due to production delays or additional costs to ensure business continuity through reliable sources of on-site power generation. Energy transmission and supply may be impacted by wildfires, such as those that occurred in Australia in 2020, which may interrupt electrical power transmission lines to mine sites, and that may pose risks to on-site facilities and energy generators, fuel dispensing systems and supplies. In jurisdictions that rely on purchased hydroelectric power, such as in Ghana and Peru, extreme drought and extended dry seasons may impact the electric utility's water supplies needed to generate hydroelectric power purchased by the mine to run operations, which would result in higher costs and/or limit energy availability for continuity of operations as well as impact the Merged Group's environmental systems and processes.

For additional information, see the risks under sections 8.2(h)(11) and 8.2(h)(13).

8. Risks

8.2 Risks relating to the business and operations of the Merged Group *continued*

11) Continued geotechnical challenges, which could adversely impact production and profitability

The Merged Group and the mining industry are facing continued geotechnical challenges due to the older age of certain of its mines and a trend toward mining deeper pits and more complex deposits. This leads to higher pit walls, more complex underground environments and increased exposure to geotechnical instability and hydrogeological impacts. As the Merged Group's operations are maturing, the open pits at many of its sites are getting deeper. Newmont has experienced geotechnical failures (such as pit wall and slope failures) at some of its mines, including, without limitation, at Newmont's operations in Australia, Ghana, Peru, Canada, Colorado and at Nevada Gold Mines in Nevada.

Unanticipated adverse geotechnical and hydrogeological conditions may occur. For example, seismic activity, such as seismic activity experienced at Newmont's Éléonore mine, surface or underground fires, floods, landslides and pit wall failures, can be difficult to predict. Such conditions are often affected by risks and hazards outside of the Merged Group's control, such as severe weather and considerable rainfall, which may lead to periodic floods, mudslides, wall instability and seismic activity, which may result in slippage of material. Such events may not be detected in advance.

In addition, the Merged Group has both operational (active and inactive) and closed tailings storage facilities (**TSFs**) in a variety of climatic and geographic settings. Annually, Newmont manages and disposes more than 100 million tonnes of milled rock slurry, referred to as tailings, that are placed within engineered, surface containment facilities, or placed as structural backfill paste in underground mines. Newmont has experienced seepage at site TSFs in the past which required Newmont to re-evaluate its emergency response systems and make facility and storage modifications. TSF seepage or failures event could occur in the future. The failure of a TSF embankment or a water storage dam at one of the Merged Group's mine sites could cause severe, and in some cases catastrophic, property and environmental damage and loss of life.

A geotechnical failure of a TSF, dam, or pit slope could result in limited or restricted access to mine sites, suspension of operations, government investigations, regulatory actions or penalties, increased monitoring costs, remediation costs and other impacts, which could result in a material adverse effect on the Merged Group's results of operations and financial position.

See also the risks under sections 8.2(h)(1), 8.2(h)(4) and 8.2(h)(8).

12) Rising energy prices or energy shortages

The Merged Group's mining operations and development projects require significant amounts of energy. Some of the Merged Group's operations are in remote locations requiring long-distance transmission of power, and in some locations, the Merged Group competes with other companies for access to third party power generators or electrical supply networks. A disruption in the transmission of energy, inadequate energy transmission infrastructure or the termination of any of the Merged Group's energy supply contracts could interrupt the Merged Group's energy supply and adversely affect its operations.

The Merged Group's principal energy sources are purchased electricity, diesel fuel, gasoline, natural gas and coal. Increasing global demand for energy, concerns about nuclear power and the limited growth of new energy sources are affecting the price and supply of energy. A variety of factors, including higher energy usage in emerging market economies, actual and proposed taxation of carbon emissions as well as concerns surrounding unrest and the war in Ukraine and conflict elsewhere, could result in increased competition and demand or limited supply of energy and/or sharply escalating diesel fuel, gasoline, natural gas and other energy prices. Availability of renewable power sources or conflicting government regulations, such as the proposed reform of the energy market in Mexico, may have an impact on the Merged Group's ability to meet its reduction targets within a specific timeline. Changes in energy laws and regulations in various jurisdictions, restrictions on energy supply and increased energy prices could negatively impact the Merged Group's operating costs and cash flow.

As the Merged Group's operations move to reduce GHG emissions, power sources and technology at Merged Group operations will continue to be evaluated and implemented. Such transitions are likely to require capital expenditures and may result in additional costs. Certain of the Merged Group's operations may also become more dependent upon access to electrical power supply as certain mines advance projects aimed at the electrification of large haulage fleets. The availability to access renewable power (with greater competition) and the readiness of technology to support decarbonisation with the timeframe of the 2030 and 2050 targets remains subject to uncertainties, which could impact the Merged Group's ability to achieve targets.

See also the risks under section 8.2(h)(9).

8.2 Risks relating to the business and operations of the Merged Group *continued*

13) Availability of sufficient water supplies and water-related risks

The Merged Group recognises the right to clean, safe water and that reliable water supplies are vital for hygiene, sanitation, livelihoods and the health of the environment. Water is also critical to the Merged Group's business, and the increasing pressure on water resources will require the Merged Group to consider both current and future conditions in its management approach. Newmont has set annual water efficiency targets at each of Newmont's operating sites. Additionally, the Merged Group will aim to achieve ambitious long-term water stewardship actions, which integrate the Merged Group's operations and value chain and support collective management of water through external partnerships and collaborations. A failure to meet the Merged Group's water targets and/or societal or investor expectations could also result in damage to its reputation, decreased investor confidence and challenges in maintaining positive community relations, which can pose additional obstacles to the Merged Group's ability to develop its projects. This may result in a material adverse impact on the Merged Group's business, financial position, results of operations and growth prospects.

The Merged Group operates water treatment plants, including at Yanacocha. Newmont is conducting detailed studies to better estimate water management and other closure activities that will ensure water quality and quantity discharge requirements, including the modifications promulgated by the Ministry of the Environment of Peru, and is performing a comprehensive update to the Yanacocha reclamation plan to address changes in closure activities and estimated closure costs while preserving optionality for potential future projects at Yanacocha. The results of these and other studies and reviews, including reviews of post-closure management costs, could result in future material increases to the reclamation obligation at Yanacocha. This may result in a material adverse impact on the Merged Group's business, financial position and cash flows, results of operations and growth prospects.

Across the globe, water is a shared and regulated resource. The Merged Group operates in areas where watersheds are under stress with limited supply, increasing population and water demand, and impacted water in various forms. Increasing pressure and competition on water use may occur due to in-migration of communities and increased populations in proximity to the Merged Group's operations. Although each of the Merged Group's operations currently have sufficient water rights, claims and contracts to cover its operational demands, the Merged Group cannot predict the potential outcome of pending or future legal proceedings or community negotiations relating to the Merged Group's water rights, claims, contracts and uses.

Water shortages and surplus may also result from weather or climate impacts outside of the Merged Group's control. Changes in the quantity of water, whether in excess or deficient amounts, may impact exploration and development activities, mining and processing operations, water management and treatment facilities, tailings storage facilities, closure and reclamation efforts, and may increase levels of dust in dry conditions and land erosion and slope stability in case of prolonged wet conditions.

Seasonality and changes in the levels of rainfall can also impact the Merged Group's operations. For example, in January 2023, Newmont's Tanami site in Australia experienced unexpected and significant rain resulting in flooding and road closure limiting Newmont's ability to get supplies to the site, causing mill backup and impacts to production. Similarly, at Boddington in Australia severe weather and heavy rainfall at Boddington caused delays and impacted productivity during the third quarter of 2021 and 2022. There is also a risk at Boddington that extended below average rainfall or the occurrence of drought in southwest Australia could impact raw water supply for the site. While Newmont has incorporated systems to address the impact of the dry season and water shortages as part of Newmont's operating plans, the Merged Group can make no assurances that those systems will be sufficient to address all shortages in water supply, which could result in production and processing interruptions.

Increased precipitation and severe storm events may potentially impact tailings storage facilities in the future by exceeding water management capacity, overtopping the facility, and/or undermining the geotechnical stability of the structure. Newmont has experienced impacts at various sites in recent years due to heavy rainfall and severe storms. For example, in 2022, Yanacocha experienced heavy rainfall, above average historical levels, which resulted in significant water balance stress and required active emergency management. Increased amounts of water may also result in flooding of mine pits, maintenance and storage facilities, or may exceed current water management and treatment capacity to store and treat water, physical conditions resulting in an unintended overflow and discharge either on or off of the mine site property.

Operations have identified seepage from infrastructure (tailings, waste rock and seepage) that may have an impact on groundwater. Newmont is currently managing this risk through monitoring, collection and treatment systems. There is a risk that the seepage could have an impact on beneficial use of groundwater resulting in increased requirements for collection and treatment as well as the potential requirement to provide alternative water sources.

Laws and regulations may be introduced in some jurisdictions in which the Merged Group operates which could limit the Merged Group's access to sufficient water resources at its operations, thus adversely affecting the Merged Group's operations. Additionally, laws, regulations and permit requirements focused on water management and discharge requirements for operations and water treatment in closure are becoming increasingly stringent. For example, at Newmont's Peñasquito operation, regulators have asserted non-conformance of water wells and subsequent use of ground water. A failure to resolve such allegations of non-compliance with regulators could result in loss of permits and restriction of such wells, which could impact the Merged Group's ability to operate the site. Newmont is also seeing increasingly stringent regulations of surface and groundwater at a number of Newmont's sites, resulting in increased monitoring and potentially the need for pump back systems and treatment in the future. New requirements and regulation have resulted or may result in increased costs and could negatively impact the Merged Group's operating costs and cash flows in the future.

See also the risks under section 8.2(f)(6), 8.2(h)(9) and 8.2(h)(11).

8. Risks

8.2 Risks relating to the business and operations of the Merged Group *continued*

i) Risks related to the jurisdictions in which the Merged Group operates

The Merged Group and its businesses, and the industries in which they operate, are subject to a number of risks related to the jurisdictions in which the Merged Group operates, including risks that are outside of its control, which could negatively impact on the Merged Group's actual operation and financial results. A non-exhaustive summary of these risks is set out in this section 8.2(i).

1) Risks associated with doing business in multiple jurisdictions

Exploration, development, production and mine closure activities are subject to regional, political, economic, community and other risks of doing business in multiple jurisdictions, including:

- potential instability of foreign governments and changes in government policies, including relating to or in response to changes of United States laws or foreign policies;
- expropriation or nationalisation of property;
- restrictions on the ability to pay dividends offshore or to otherwise repatriate funds;
- restrictions on the ability of local operating companies to sell gold and other metals offshore for US dollars, or on the ability of such companies to hold US dollars or other foreign currencies in offshore bank accounts;
- import and export regulations, including restrictions on the export of gold, silver, copper, zinc and/or lead;
- disadvantages relating to submission to the jurisdiction of foreign courts or arbitration panels or enforcement or appeals of judgments at foreign courts or arbitration panels against a sovereign nation within its own territory;
- royalty and tax increases or claims, including retroactive increases and claims and requests to renegotiate terms of existing investment agreements, contracts of work, leases, royalties and taxes, by governmental entities, including such increases, claims and/or requests by the governments in the jurisdictions in which the Merged Group operates;
- changes in laws or regulations in the jurisdictions in which the Merged Group operates, including in changes resulting from changes in political administrations;
- risk of increased taxation related to impacts to government revenue as a result of challenging socioeconomic conditions, including recessions and/or in connection with health and community emergencies, such as COVID-19 and other pandemics, epidemics or outbreaks;
- fines, fees, and sanctions imposed for failure to comply with the laws and regulations of the jurisdictions in which the Merged Group operates;
- risk of loss due to inability to access the Merged Group's properties or operations;
- other risks arising out of foreign sovereignty over the areas in which the Merged Group's operations are conducted, including risks inherent in contracts with government owned entities such as unilateral cancellation or renegotiation of contracts, licenses or other mining rights;
- delays in obtaining or renewing, or the inability to obtain, maintain or renew, necessary governmental permits, mining or operating leases and other agreements and/or approvals;
- risk of loss due to civil strife, acts of war, guerrilla activities, insurrection and terrorism;
- claims for increased mineral royalties or ownership interests or profit sharing and challenges by local or Indigenous communities;
- risk of loss due to criminal activities such as trespass, blockade, local artisanal or illegal mining, organised crime by drug cartels, theft and vandalism;
- delays in obtaining or renewing collective bargaining or certain labour agreements;
- disadvantages of competing against companies from countries that are not subject to the rigorous laws and regulations of the United States or other jurisdictions, including without limitation, the United States Foreign Corrupt Practices Act, the UK Bribery Act 2010 and the Dodd-Frank Wall Street Reform and Consumer Protection Act;
- increases in training and other costs and challenges relating to requirements by governmental entities to employ the nationals of the country in which a particular operation is located;
- increased financing costs;
- currency fluctuations, particularly in countries with high inflation;
- foreign exchange controls;
- increases in costs relating to, or restrictions or prohibitions on, the use of ports for concentrate storage and shipping, or in relation to the Merged Group's ability to procure economically feasible ports for developing projects;
- risk of disruption, damage or failure of information technology systems, and risk of loss and operational delays due to impacts to operational technology systems, such as due to cyber-attacks, malicious software computer viruses, security breaches, design failures and natural disasters;
- risk of loss due to disease, such as malaria or the zika virus, and other potential medical endemic or pandemic issues, such as Ebola or COVID-19, as a result of the potential related impact to employees, disruption to operations, supply chain delays, trade restrictions and impact on economic activity in affected countries or regions; and
- disadvantage and risk of loss due to the limitations of certain local health systems and infrastructure to contain diseases and potential endemic health issues.

Consequently, the Merged Group's exploration, development and production activities may be affected by these and other factors, many of which are beyond the Merged Group's control, some of which could materially adversely affect the Merged Group's financial position or results of operations.

8.2 Risks relating to the business and operations of the Merged Group *continued*

2) Changes in mining or investment policies or shifts in political and social attitudes in the Merged Group's operating jurisdictions

The Merged Group's operations may be affected in a number of ways by laws and regulations which are related, but not limited to: restrictions on production; price controls; export controls; and import restrictions, such as restrictions applicable to, among other things, equipment, services and supplies, currency remittance, income taxes, expropriation of property, foreign investment, maintenance of mineral claims, environmental legislation, land use, surface land access, land claims of local communities, water use, and mine safety. Failure to comply strictly with applicable laws, regulations and local practices relating to mineral right applications and tenure could result in loss, reduction or expropriation of entitlements, or the imposition of additional local or foreign parties as partners with carried or other interests, any of which may adversely affect the Merged Group's operations or profitability.

In addition, as governments continue to struggle with deficits and concerns over the potential and actual effects of depressed economic conditions (including in connection with COVID-19 impacts), many of them have targeted the mining and metals sector in order to raise revenue. Governments are continually assessing the fiscal terms of the economic rent for a mining company to exploit resources in their countries. Numerous countries have implemented changes to their mining regimes that reflect increased government control over or participation in the mining sector, including, but not limited to, changes of law affecting foreign ownership and takeovers, mandatory government participation in mining enterprises, taxation and royalties, working conditions, rates of exchange, exchange controls, exploration licensing, export duties, requirements to sell to the government, repatriation of income or return of capital, environmental protection, as well as requirements intended to boost the local economy, including usage of local goods and employment of local and community staff or contractors, among other benefits to be provided to local residents. The effects of the various requirements and uncertainties related to the economic risks of operating in diverse jurisdictions cannot be accurately predicted and could have a material adverse effect on the Merged Group's financial position or results of operations. Some concern exists with respect to investments in parts of the world where civil unrest, war, nationalist movements, political violence or economic crises are possible. These countries may also pose heightened risks of expropriation of assets, business interruption, increased taxation or unilateral modification of concessions and contracts. The Merged Group will not maintain insurance policies against political risk. Occurrence of events for which the Merged Group is not insured may affect the Merged Group's results of operations and financial position.

3) Political and social unrest risks at Yanacocha operations and Conga project in Peru

Minera Yanacocha S.R.L. (**Yanacocha**), including the mining operations at Yanacocha and the Conga project in Peru, has been the target of local political and community protests, some of which blocked the road between the Yanacocha mine and Conga project complexes and the City of Cajamarca in Peru and resulted in vandalism and equipment damage. While recently roadblocks and protests have diminished and focused on local political activism and labour disputes, Newmont cannot predict whether similar or more significant incidents will occur in the future. The recurrence of significant political or community opposition or protests could continue to adversely affect the Conga project's development, other new projects in the area and the continued operation of Yanacocha.

Construction activities on Newmont's Conga project were suspended in 2011, at the request of Peru's central government following protests in Cajamarca by anti-mining activists led by the regional president. At the request of the Peruvian central government, the environmental impact assessment prepared in connection with the project was reviewed by independent experts in an effort to resolve allegations around the environmental viability of Conga. This review concluded that the environmental impact assessment complied with international standards and provided recommendations to improve water management. Based on its internal project portfolio evaluation process, Newmont has reprioritised other projects ahead of the Conga project, and therefore do not anticipate developing Conga in the next ten years. Due to the uncertainty surrounding the project's development timeline, Newmont has allocated exploration and development capital to other projects in its portfolio. As a result, the Conga project is currently in care and maintenance and Newmont will continue to evaluate long-term options to progress development of the Conga project. Should the Merged Group be unable to develop the Conga project or conclude that future development is not in the best interest of the business, a future impairment charge may result.

4) Political and economic risks at Merian operation in Suriname

The Merged Group will hold a 75% interest in the Merian gold mine (**Merian**) in the mid-eastern part of Suriname. Suriname has experienced political instability and uncertainty in the past which may continue in future years. Suriname is faced with high debts to foreign creditors, significant inflation rates and has experienced a hyperinflationary economy. Significant devaluation of the Surinamese dollar against the US dollar in recent years has resulted in an increase of the prices of certain goods and services within Suriname, including without limitation, the price of fuel, which had been subsidised by successive governments. The government of Suriname recently passed a new law to introduce Value Added Tax, which came into effect on 1 January 2023 and has drastically increased the cost of living and negatively impacts the purchasing power of the residents of Suriname, including Newmont employees. These impacts and negative economic trends can cause social unrest, which may present risks for the Merged Group's operations in Suriname.

Operations and development in Suriname are governed by a mineral agreement with the Republic of Suriname. The mineral agreement was approved by parliament and requires approval by parliament to change. However, in 2021, the government made requests for prepayment of taxes and special solidarity payments in light of budgetary concerns. As such, it is possible that the government may request changes to the mineral agreement in the future. While the government is generally considered by Newmont to be mining friendly, it is possible that the current or future government may adopt substantially different policies, make changes in taxation treatment or regulations, take arbitrary action which might halt operations, increase costs, or otherwise impact mining and exploration rights and/or permits, any of which could have a material and adverse effect on the Merged Group's future cash flows, earnings, results of operations and/or financial condition.

8. Risks

8.2 Risks relating to the business and operations of the Merged Group *continued*

The government of Suriname previously exercised an option to participate in a fully funded 25% equity ownership stake in Merian. Suriname manages its participation through Staatsolie Maatschappij Suriname N.V. (**Staatsolie**), a Surinamese corporation with the Republic of Suriname as sole shareholder. If Staatsolie does not have sufficient funds or borrowing ability to make their capital commitments in accordance with the terms of the partnership agreement, the Merged Group's operations in Suriname could be impacted. See also the risks under section 8.2(g)(2).

5) Political, economic and other risks at Ahafo and Akyem operations in Ghana

Newmont operates in Ghana pursuant to a Revised Investment Agreement ratified by Ghana's Parliament in 2015, which established a fixed fiscal and legal regime, including fixed royalty and tax rates, for Newmont operations in Ghana. The Merged Group will operate in Ghana on a similar basis. The financial and tax stability periods established by such agreements expire as early as 2025 for Ahafo and 2027 for Akyem. The Republic of Ghana has experienced worsening socioeconomic conditions in recent years. The Ghanaian cedi has experienced significant depreciation with inflation accelerating to 54.1% at the end of 2022. Ghana's credit rating worsened to speculative grade, at near default to default levels, as the Ghanaian Finance Ministry announced suspension of debt service payments in December 2022 on the majority of its external debt, including commercial and bilateral loans, and that Ghana was seeking to restructure its debt. Efforts in early 2023 to put in place a domestic debt exchange program have faced setbacks from pension funds and by individual bond holders leading to amended terms. Continued economic recession and/or unfavourable macroeconomic indicators have also resulted in pressures from the Government of Ghana to obtain more revenue and benefits from mining companies on the back of anti-mining sentiment and perceived inequities that the industry is not contributing its fair share. To address budgetary deficits, the Government of Ghana has in the past initiated measures to generate additional revenue from the mining industry and other sectors of the economy as it attempts to increase revenue collection through various tax audits and investigations, proposed new fees, increased revenue and tax initiatives and other vehicles, such as the proposed Growth and Stabilisation Levy as well as new local content regulation. Other risks include impacts to supply chain, restrictions and local procurement requirements, increase in key commodity prices, more restrictive local banking requirements including requirements for repatriation of proceeds to banks domiciled in Ghana, limitations on capacity of banks to provide reclamation bonds, requests for further local employment requirements, requests for contract renegotiation and increases in contract rates and other costs. Additionally, the government may grant artisanal mining rights or alternative mining rights, such as sand and gravel, in locations in which Newmont has land rights, but no active operations, impacting the Merged Group's non-operational land positions. Economic setbacks and anti-mining sentiment can also result in an increase in community frustration and friction with artisanal small-scale mining resulting in conflicts, which can negatively impact the Merged Group's operations in Ghana.

6) Risks as a result of labour unrest and economic and political instability in Argentina

There continue to be risks relating to the uncertain and unpredictable political and economic environment in Argentina, especially at the provincial level in Santa Cruz where Newmont's Cerro Negro mine is located. Inflation remains a challenge in Argentina and Argentina's central bank enacted a number of foreign currency controls in 2019 and 2020 in an effort to stabilise the local currency. Maintaining operating revenues in Argentine pesos could expose the Merged Group to the risks of peso devaluation and high domestic inflation.

In recent years, Newmont has experienced work stoppages by miners represented by unions at the Cerro Negro mine. Disruptions may arise again in the future with the unions at the Cerro Negro mine or with the local communities and unions that could adversely affect access to, and operations at, the Cerro Negro mine.

7) Social, political, regulatory and economic risks at the Peñasquito operation in Mexico

Newmont's Peñasquito operation has in the past, and may in the future, be affected significantly and adversely by social, political, regulatory, or economic developments in Mexico. A wide range of general and industry-specific Mexican federal and state environmental laws and regulations apply to Newmont's operations and will continue to apply to the Merged Group. These laws and regulations are often difficult and costly to comply with and carry substantial penalties for non-compliance. For example, in the State of Zacatecas, Mexico, environmental taxes became effective in 2017 with little clarity on how the taxes are to be calculated. An ecological tax agreement was ratified in 2021 which provides clarity for 2021 to 2024, after which, the Merged Group, along with other companies in the State of Zacatecas, will need to engage with governmental authorities to understand how the environmental tax would be levied year-over-year. Additionally, in May 2023, the Mexican government published several amendments to laws relating to the country's mining industry, which includes changes to Mexico's Mining Law, National Waters Law, General Law of Ecological Equilibrium and Environmental Protection and General Law for the Prevention and Integral Handling of Wastes (**Mining Reform**). The Mining Reform is expected to add significant uncertainty for foreign investors in Mexico and companies operating in the mining sector, including the Merged Group. As a result of the Mining Reform, Newmont expects that it will be more difficult for the Merged Group to access and maintain rights to land and water, thereby negatively impacting mining activities within Mexico, raising concerns around exploration programs, security of concessions, and out of cycle community negotiations. If political and regulatory trends continue in a manner that is increasingly less supportive of mining, it can have an adverse impact on the Merged Group's operations and financial results.

8.2 Risks relating to the business and operations of the Merged Group *continued*

Production at the Peñasquito operation is dependent upon the efforts of employees and, consequently, the maintenance of good relationships with employees. In recent years, Newmont has had several disputes with the National Union of Mine and Metal Workers of the Mexican Republic (**Union**). Following negotiations in 2022, Newmont and the Union reached a Collective Bargaining Agreement (**CBA**) in June 2022 whereby Union represented workforce will participate in uncapped profit-sharing bonus up to 10%, which resulted in increased labour costs. In June 2023, the Union made claims regarding violations of legal regulations and labour agreements (which Newmont refuted) and notified Newmont of a strike action demanding an increase in the uncapped profit-sharing benefit provided for in the CBA from 10% to 20%, representing a 100% increase. Newmont urged the Union to abide by the mutually agreed CBA and engaged in dialogue with the Union and the government, but the disagreement remains unresolved. In response to the strike notice, Minera Peñasquito suspended operations and the related shut down remains ongoing. A failure to successfully resolve ongoing Union complaints could result in continuation of work stoppages and/or other future disruptions in production and labour issues that could adversely affect the Merged Group's operations and financial performance and its ability to achieve expected results and guidance. Prolonged failure to resolve disputes and disruptions at Newmont's Peñasquito operation could also cause the Merged Group to reassess investments in Mexico in the future. See also section 8.2(j)(1).

A deterioration in Mexico's economy, social instability, political unrest, or other adverse social developments in Mexico could also adversely affect operating results at Peñasquito, as well as the safety and security of the site and workforce. For example, in recent years, Mexico has experienced a period of increasing criminal activity, primarily due to the activities of drug cartels and related criminal organisations, including in the State of Zacatecas. Any increase in the level of violence or a concentration of violence near or around the Peñasquito mine could have an adverse effect on the Merged Group's operating results. See also section 8.2(h)(6) for further information on the risk of civil disturbances and criminal activities.

j) Risks related to the Merged Group's workforce

The Merged Group and its businesses, and the industries in which they operate, are subject to a number of workforce risks, including risks that are outside of the Merged Group's control, which could negatively impact on the Merged Group's actual operational and financial results. A non-exhaustive summary of these risks is set out in this section 8.2(j).

1) The maintenance of good relations with the Merged Group's employees

Production at the Merged Group mines is dependent upon the efforts of employees and, consequently, the Merged Group maintaining good relationships with its employees. Due to union activities or other employee actions, the Merged Group could experience labour disputes, work stops or other disruptions in production that could adversely affect it. For example, at 31 December 2022, various unions represented approximately 33% of Newmont's employee workforce worldwide. Future disputes at the Merged Group's operations, projects or joint ventures may not be resolved without disruptions.

2) The Merged Group being unable to recruit, hire, retain and develop key personnel and a qualified and diverse workforce

The Merged Group will depend upon the services of a number of key executives and management personnel, and the contributions of its highly skilled and experienced workforce. The Merged Group's ability to achieve its operating goals depends upon its ability to recruit, hire, retain and develop qualified and diverse personnel to execute on its strategy. The Merged Group will be fundamentally committed to creating and maintaining a work environment in which employees are treated fairly, with dignity, decency, respect and in accordance with all applicable laws. A failure by the Merged Group to comply with relevant law and policies applicable in respect of its workforce could have a financial and/or reputational impact. Newmont recognises that bullying, sexual harassment and harassment based on other protected categories, including race, have been prevalent in every industry, including the mining industry. Features of the mining industry, such as being a historically hierarchical and male-dominated culture, create risk factors for harmful workplace behaviour. While Newmont does not, and the Merged Group will not, tolerate discrimination and harassment of any kind (including but not limited to sexual orientation, gender identity, race, religion, ethnicity, age, or disability, among others), their policies and processes may not prevent or detect all potential harmful workplace behaviours. Newmont occasionally identifies or is apprised of information or allegations that certain employees, affiliates, agents or associated persons may have engaged in harmful behaviours and improper, inappropriate or unlawful conduct, including but not limited to bullying, discrimination and harassment. If the Merged Group fails to maintain a safe, respectful and inclusive work environment, it could impact the Merged Group's ability to retain talent and maintain a diverse workforce and damage its reputation. There continues to be competition over highly skilled personnel in the mining industry. If the Merged Group loses key personnel, or one or more members of its senior management team, and fails to develop adequate succession plans, or if fails to hire, retain and develop qualified and diverse employees, its business, financial condition, results of operations and cash flows could be harmed.

The Merged Group's business is dependent upon its workforce being able to safely perform their jobs, including the potential for physical injuries or illness. If the Merged Group experiences periods where its employees are unable to perform their jobs for any reason, including as a result of illness (such as COVID-19), its operations could be adversely affected. In addition to physical safety, protecting the psychological safety of employees is necessary to maintaining a safe, respectful and inclusive work environment. If the Merged Group fails to maintain a safe environment that is free of harassment, discrimination or bullying, it could adversely impact employee engagement, performance and productivity, result in potential legal claims and/or damage the Merged Group's reputation, which could have a material adverse effect on its business, financial position and results of operations or adversely affect its market value.

See also the risks under sections 8.2(f)(7) and 8.2(f)(8).

8. Risks

8.2 Risks relating to the business and operations of the Merged Group *continued*

3) The Merged Group will rely on contractors to conduct a significant portion of its operations and construction projects

A significant portion of Newmont's operations and construction projects are currently conducted in whole or in part by contractors, and this will remain the case for the Merged Group. As a result, its operations are subject to a number of risks, some of which are outside the Merged Group's control, including:

- negotiating agreements with contractors on acceptable terms;
- new legislation limiting or altering the ability to utilise contractors or outsourced resources;
- the inability to replace a contractor and its operating equipment in the event that either party terminates the agreement;
- reduced control over those aspects of operations which are the responsibility of the contractor;
- failure of a contractor to perform under its agreement;
- interruption of operations or increased costs in the event that a contractor ceases its business due to insolvency or other unforeseen events;
- failure of a contractor to comply with applicable legal and regulatory requirements, to the extent it is responsible for such compliance; and
- problems of a contractor with managing its workforce, labour unrest or other employment issues; and
- liability to third parties as a result of the actions of contractors.

In addition, law and regulations relating to the use of contractors may vary in the jurisdictions in which the Merged Group operates, and changes in legal and regulatory restrictions may also impact its ability to utilise contractors and outsourcing services. Further changes in law and the occurrence of one or more of these risks could adversely affect the Merged Group's results of operations and financial position.

k) Legal risks

The Merged Group and its businesses, and industries in which they operate, are subject to a number of legal risks, including risks that are outside of its control, which could negatively impact on the Merged Group's actual operational and financial results. A non-exhaustive summary of these risks is set out in this section 8.2(k).

1) The Merged Group's business will be subject to the United States Foreign Corrupt Practices Act and other anti-bribery laws and regulations, breach or violation of which could lead to substantial sanctions and civil and criminal prosecution, as well as fines and penalties, litigation, loss of licenses or permits and other collateral consequences and reputational harm

The Merged Group will operate in certain jurisdictions that have experienced governmental and private sector corruption to some degree, and, in certain circumstances, compliance with anti-bribery laws and heightened expectations of enforcement authorities may be in tension with certain local customs and practices. The United States Foreign Corrupt Practices Act and other laws with extraterritorial reach, including the UK Bribery Act 2010, and anti-bribery laws in other jurisdictions in which the Merged Group operates generally prohibit companies and their intermediaries from making improper payments for the purpose of obtaining or retaining business or other commercial advantage.

The Merged Group could be held responsible if its internal control policies and procedures fail to protect it from misinterpretation of or non-compliance with applicable anti-bribery laws, regulations and internal policies, recklessness, fraudulent behaviour, dishonesty or other inappropriate acts committed by the Merged Group's affiliates, employees, agents or associated persons for which the Merged Group might be claimed to be responsible. As such, the Merged Group's corporate policies and processes may not prevent or detect all potential breaches of law or other governance practices.

In addition, the compliance mechanisms and monitoring programs adopted and implemented by Goldcorp prior to Newmont's acquisition of Goldcorp in April 2019 may not have adequately prevented or detected possible violations of the United States Foreign Corrupt Practices Act and the Corruption of Foreign Officials Act (Canada) attributable to Goldcorp prior to Newmont's acquisition of Goldcorp and the Merged Group may be held liable for any such violations. Newmont has occasionally identified or been apprised of information or allegations that certain employees, affiliates, agents or associated persons may have engaged in improper or unlawful conduct for which the Merged Group might be held responsible. The Merged Group's policy when receiving credible information or allegations will be to conduct internal investigations and compliance reviews to evaluate that information, determine compliance with applicable anti-bribery laws and regulations and policies and take such remedial steps as may be warranted. In appropriate circumstances, the Merged Group will communicate with authorities in the United States and elsewhere about those investigations and reviews. Violations of these laws, or allegations of such violations, could lead to substantial sanctions and civil and criminal prosecution, as well as fines and penalties, litigation, loss of operating licenses or permits and other collateral consequences, and may damage the Merged Group's reputation, which could have a material adverse effect on its business, financial position and results of operations or cause the market value of Newmont Securities to decline.

8.2 Risks relating to the business and operations of the Merged Group *continued*

2) Title to some of the Merged Group's properties may be insufficient, defective or challenged

The sufficiency or validity of the Merged Group's rights, titles, or interests in and to its properties (**Legal Title**) may be uncertain or challenged by third parties, including governmental authorities, Indigenous or communal peoples, or private parties. For example, at Newmont's Conga project in Peru, Newmont continues to seek resolution to a land dispute with local residents. In Mexico, exploration and mining rights are granted through a mining concession, pertaining to the mineral estate, and do not include rights of ownership, possession, or access in or to the corresponding surface estate. Such rights in and to the surface estate are acquired through purchase, lease, or easement from private parties, local communities, or governmental authorities. Newmont enters into temporary occupation agreements ranging from five to 30 years with the Ejido communities, which allow Newmont to use the surface of the lands for its mining operations, and at any particular time Newmont may be involved in negotiations to enter into new temporary occupation agreements or other surface access agreements or amend existing agreements. Failure to reach new agreements or disputes regarding existing agreements may cause blockades, suspension of operations, delays to projects, and on occasion, may lead to legal disputes.

In addition, certain Australian and Canadian properties are owned by Indigenous peoples or are subject to certain inherent aboriginal rights, treaty rights, and/or asserted rights in and to their traditional territories, and the Merged Group's ability to acquire necessary rights to explore, develop, or mine these properties is dependent on agreements with them. The Merged Group's ability to secure such agreements may be dependent on formal determinations of Indigenous or Native title rights issued by governmental authorities, the lack or delay of which may impede the Merged Group's ability to explore, develop, or mine. In French Guiana, Ghana and Suriname, Legal Title may be subject to challenge based on the presence and activities of artisanal miners. A determination of insufficient or defective Legal Title or risks in connection with a challenge to Legal Title could result in loss of Legal Title, litigation, insurance claims, the impairment, preclusion, or cessation of exploration, development, or mining operations, and potential losses affecting the Merged Group's business as a whole.

See also the risks under section 8.2(h)(5).

l) The Merged Group will be subject to the operational risks faced by Newcrest

If the Scheme is implemented, the operational risks faced by Newcrest, including those in section 8.4(b), will apply to the Merged Group.

For more information, see the risks set out in section 8.4(b).

8.3 Risks relating to Newmont Shares and Newmont CDIs

a) Liquidity and flowback

There is a risk that the market for Newmont CDIs may be less liquid than the market for Newmont Shares. If this risk is realised, the volume of Newmont Shares that can be bought and sold on the ASX and the speed with which they can be bought and sold will be reduced. This may result in Newmont CDIs trading at a discount to Newmont Shares trading on NYSE.

As set out in section 7.8(c)(9), holders of Newmont CDIs can convert their Newmont CDIs into Newmont Shares. If those Newcrest Shareholders who receive Newmont CDIs as Scheme Consideration (or future Newmont CDI holders) subsequently convert their Newmont CDIs into Newmont Shares, this may further reduce the liquidity in the market for Newmont CDIs and increase the likelihood that Newmont CDIs will trade at a discount to Newmont Shares.

Newmont was previously admitted to the Official List of the ASX on 25 February 2002 and its securities traded on the ASX by way of Newmont CDIs. Newmont was subsequently delisted from the ASX on 17 February 2010 due to low levels of trading in Newmont CDIs as a result of the transmutation of Newmont CDIs to Newmont Shares.

In addition, if a large number of Newcrest Shareholders do not intend to continue to hold the Newmont Shares or Newmont CDIs received as Scheme Consideration and instead choose to sell, there is a risk that the trading price of Newmont Shares and Newmont CDIs will be adversely impacted by selling.

As set out in section 11.5, the Sale Agent will be issued Newmont Shares attributable to certain Ineligible Foreign Shareholders and will be seeking to sell those securities on NYSE as soon as reasonably practicable, which may also contribute to any potential adverse impact on the trading price of the Newmont Shares.

b) Volatility of Newmont CDIs

Newmont CDIs will be quoted and trade on the ASX in Australian dollars, whereas Newmont Shares will be quoted and trade on NYSE in US dollars. The price of Newmont CDIs will be subject to, and reflect movements in, both the Newmont Share price and the AUD:USD exchange rate. These dual movements may cause Newmont CDIs to be more volatile than Newcrest Shares have historically been.

c) Trading of Newmont CDIs during deferred settlement trading period

Scheme Shareholders who are to receive Newmont CDIs will not necessarily know the exact number of Newmont CDIs they will receive (if any) until a number of days after those securities can be traded on the ASX on a deferred settlement basis. Scheme Shareholders who trade Newmont CDIs on a deferred settlement basis without knowing the exact number of Newmont CDIs they will receive as Scheme Consideration may risk adverse financial consequences if they purport to sell more Newmont CDIs than they ultimately receive.

d) Different rights - Newmont Shares

If the Scheme is implemented, the rights attaching to Newmont Shares issued as Scheme Consideration will be primarily governed by the DGCL, the United States federal securities laws, NYSE Listing Rules and Newmont's certificate of incorporation and by-laws.

8. Risks

8.3 Risks relating to Newmont Shares and Newmont CDIs *continued*

e) Different rights – Newmont CDIs

The holder of a Newmont CDI has an indirect, beneficial interest in the Newmont Share underlying their Newmont CDI instead of directly owning the Newmont Share. This means that the holder of the Newmont CDI is not the registered legal holder of the underlying Newmont Share and therefore:

- cannot directly trade the underlying Newmont Share; and
- is a beneficial holder (rather than a registered legal holder) of the underlying Newmont Share.

The differences between Newmont Shares and Newmont CDIs are summarised in section 7.8(d).

f) Volatility of the market price of Newmont Shares

As a publicly traded company listed on the NYSE and TSX, the market price and volume of Newmont Shares may be subject to significant fluctuations due not only to general stock market conditions but also to a change in sentiment in the market regarding Newmont's operations, business prospects or liquidity. In addition to the factors discussed in this section 8 and elsewhere in this Scheme Booklet, among the factors that could affect the price of Newmont Shares are:

- changes in gold, and to a lesser extent, silver, copper, zinc or lead prices;
- operating and financial performance that vary from the expectations of management, securities analysts and investors or Newmont's financial outlook;
- developments in Newmont's business or in the mining sector generally;
- regulatory changes affecting Newmont's industry generally or Newmont's business and operations;
- the operating and share price performance of companies that investors consider to be comparable to Newmont;
- announcements of strategic developments, acquisitions and other material events by Newmont or its competitors;
- Newmont's ability to integrate and operate the companies and the businesses that it acquires;
- the perception of Newmont's ESG performance and its ability to deliver on ESG commitments and expectations, including in connection with Newmont's climate strategy;
- response to activism; and
- changes in global financial markets and global economies and general market conditions, such as interest or exchange rates, stock, commodity, credit or asset valuations or volatility.

Additionally, the stock markets in general have experienced extreme volatility that has at times been unrelated to the operating performance of particular companies, and the COVID-19 pandemic has increased, and may continue to increase, volatility and pricing in the capital markets. These broad market fluctuations may adversely affect the trading price of Newmont Shares.

In addition, the market price of Newmont Shares may be adversely impacted if a large number of Newcrest Shareholders choose to sell their Newmont Shares or Newmont CDIs following implementation of the Scheme.

g) The market price of Newmont Shares may be adversely affected as a result of the Scheme

On implementation of the Scheme, a significant number of additional Newmont Shares will be issued and available for trading in the public market. The increase in the number of Newmont Shares may lead to sales of such shares or the perception that such sales may occur (commonly referred to as "market overhang"), either of which may adversely affect the market for, and the market price of, Newmont Shares (and Newmont CDIs).

In addition, if the Scheme is not implemented, the market price of Newmont Shares could decline to the extent that it reflects an assumption that the Scheme will be implemented or is material to Newmont's business strategy.

h) Holders of Newmont Shares and Newmont CDIs may not receive dividends

Newmont Stockholders (including those who hold Newmont CDIs) are entitled to receive only such dividends as the Newmont Board of Directors may declare out of funds legally available for such payments. Newmont is incorporated in the State of Delaware and governed by the DGCL. DGCL allows a corporation to pay dividends only out of surplus, as determined under DGCL or, if there is no surplus, out of net profits for the fiscal year in which the dividend was declared and for the preceding fiscal year. Under DGCL, however, Newmont cannot pay dividends out of net profits if, after it pays the dividend, its capital would be less than the capital represented by the outstanding stock of all classes having a preference upon the distribution of assets. The Merged Group's ability to pay dividends will be subject to its future earnings, capital requirements, financial condition, compliance with covenants and financial ratios related to existing or future indebtedness and other factors deemed relevant by the Newmont Board. Although Newmont has historically declared cash dividends on its Newmont Shares, the Merged Group is not required to declare cash dividends on Newmont Shares (and, by extension, Newmont CDIs). An annualised dividend payout level has not been declared by the Newmont Board, and the declaration and payment of future dividends, including future quarterly dividends, remains at the discretion of the Newmont Board. Newmont's dividend framework is non-binding, and the Newmont Board may modify the dividend framework or reduce, defer or eliminate the Newmont Share dividend in the future.⁵⁹

59. Refer to sections 6.7 and 7.3(d) for further details on Newmont's non-binding dividend framework.

8.4 Risks relating to the Newcrest Group if the Scheme is not implemented

If the Scheme does not proceed, Newcrest will continue as a standalone entity and Newcrest Shareholders will retain their Newcrest Shares. In these circumstances, Newcrest may be subject to the risks set out in this section 8.4.

a) Risks arising from the consequences of the Scheme not being implemented

1) Newcrest Shareholders will not receive the Scheme Consideration or Special Dividend

If the Scheme is not implemented, Newcrest Shareholders will retain their Newcrest Shares and will not receive the Scheme Consideration or Special Dividend. If the Scheme is not implemented, Newcrest would remain listed on ASX, TSX and PNGX and would continue to operate its business. In those circumstances, Newcrest Shareholders will continue to be exposed to the risks and benefits of owning Newcrest Shares and Newcrest's dividend policy will continue to apply.

2) If the Scheme does not proceed, the price of a Newcrest Share may fall below its recent trading price, in the absence of a Superior Proposal

The market price of a company's publicly traded securities is affected by many variables, including those variables described in section 8.3(f). There can be no assurance that such fluctuations will not affect the price of Newcrest Shares in the future if the Scheme does not proceed.

The trading price of a Newcrest Share rose by 9.3% on the day of the announcement of the initial approach by Newmont, and also rose 1.5% on the day it was announced that the Scheme Implementation Deed had been agreed. Since market close on 3 February 2023 (being the last day on which Newcrest Shares traded before the initial offer from Newmont was announced), the Newcrest Share price has increased 14.8% up to a closing price of A\$25.77 on the Last Practicable Date, outperforming its peers on the ASX Gold Index and VanEck Miners Index by 9.1% and 11.1% respectively.

If the Scheme is not approved and no comparable proposal or Superior Proposal emerges it is expected that the trading price of Newcrest Shares will fall.

3) Transaction costs will be incurred

If the Scheme is not implemented, Newcrest's transactions costs will be borne by Newcrest alone, subject to any off-set by way of any reverse break fee payment from Newmont (if applicable). Newcrest may also be required to pay a break fee to Newmont, depending on the circumstances in which the Scheme does not proceed. Further information regarding the break fee and the circumstances in which it may become payable are described in section 11.4 (together with the reverse break fee that may become payable by Newmont).

4) Reliance on personnel

The responsibility of overseeing the day-to-day operations and the strategic management of Newcrest depends substantially on its senior management and Newcrest's Directors. In addition, Newcrest is reliant on the contributions made by its workforce.

While Newcrest will make every effort to attract and retain personnel required to support its business, the loss of personnel, or an inability to attract suitably qualified personnel, could disrupt Newcrest's operations and may have a material adverse impact on Newcrest's revenues, financial performance and growth potential. Newcrest's efforts to retain, attract and develop key personnel may also result in additional expenses which could adversely impact its financial performance and profitability.

At the time of the offer made by Newmont for Newcrest, the Newcrest Board had appointed Sherry Dube as Newcrest's Interim Chief Executive Officer and was conducting a global internal and external search for a new Chief Executive Officer. If the Scheme does not proceed, the Newcrest Board intends to continue that search, which may take some time to conclude.

Company culture is a key factor in achieving Newcrest's strategic goals, as Newcrest seeks to create a high-performing, inclusive culture that contributes to collaboration, creativity where employees maintain an owner's mindset. Enhancing culture is therefore a commitment made by the Executive Management team and is the responsibility of all senior leaders of Newcrest and is the expectation of the workforce. While the Scheme has not diminished Newcrest's focus on and commitment to culture, the pendency of the transaction and potential uncertainty regarding the future in light of the transaction may adversely impact on culture. If the Scheme is not implemented, Newcrest will work towards restoring, and eliminating any adverse impact on, the company's culture, which may take time and will be linked to the ability to continue to attract, retain and develop personnel. Newcrest would seek to continue to adopt and implement policies and processes that reinforce the values and behaviours expected in the workplace and also continue to conduct training on inclusive leadership skills for leaders across the organisation.

5) The benefits associated with the Merged Group will not be realised

If the Scheme is not implemented, Newcrest will remain listed on the ASX, TSX and PNGX as a standalone entity, and the benefits anticipated from the Merged Group will not be realised.

8. Risks

8.4 Risks relating to the Newcrest Group if the Scheme is not implemented *continued*

b) Other risks for Newcrest as a standalone entity

Irrespective of whether the Scheme is implemented, or the Scheme does not proceed, Newcrest will continue to be exposed to ongoing risks, including those which currently apply to an investment in Newcrest.

Many of the risks described in section 8.2 also apply to an investment in Newcrest as a standalone entity. Some or all of the risks described in section 8.2 may be more concentrated or have a more significant adverse effect on Newcrest as a standalone entity than they would on the Merged Group. In addition, Newcrest Shareholders may be subject to the following risks that are specific to Newcrest (including to the extent they represent specific examples of risks that are described more broadly in section 8.2) and will also apply to an investment in the Merged Group if the Scheme is implemented.

1) Gold and copper mining companies are subject to extensive environmental laws and regulations, and noncompliance with these requirements can result in sanctions, including suspension of environmental permits, fines and temporary or permanent disruptions to mining operations and projects, claims for damages, complaints from the local community and reputational harm

As described in section 8.2(h)(8), mining activities, including those conducted by Newcrest, are subject to extensive environmental laws and regulations in the various jurisdictions in which these operations are conducted. Compliance with environmental laws and regulations are subject to regular change and require significant expenditure, and noncompliance may result in enforcement action, fines, prosecutions or other sanctions, requirements to take improvement actions, including changes to production and investments in pollution control technologies, claims for personal injury or property damage or other loss, or inability to maintain or secure necessary licenses and permits, as well as reputational harm. Specific examples where Newcrest faces such risks include the following.

A) Waste Rock and Tailings Management

Newcrest's mining and ore refining/metals extraction processes generate waste by-products such as waste rock (managed in waste rock dumps or, in the case of Lihir, harbour waste rock platforms and permitted barge dumping locations) and tailings (managed by the use of tailings storage facilities, lacustrine deposition in the case of Brucejack or DSTP in the case of Lihir and as proposed at Wafi-Golpu). Tailings storage facilities are constructed progressively throughout the life of the mine to support increasing capacity requirements. If there is a failure in the integrity of a tailings storage facility, there is a risk that tailings or large volumes of water and/or potentially contaminating materials may be released and cause material harm to human health and/or the environment downstream of the facility. Such an occurrence could severely damage Newcrest's reputation and materially adversely impact its operating results and financial condition. It may also subject Newcrest to civil and or criminal action, penalties and claims from environmental and planning regulators and/or affected third parties, and may lead to the suspension or disruption of Newcrest's operations and projects.

B) Tailings Storage Facilities and Dust Emissions at Cadia

Tailings deposition was suspended at Cadia Holdings Pty Ltd's (**Cadia Holdings**) tailings storage facilities in March 2018 following an embankment slump of its Northern Tailings Storage Facility (**NTSF**), and deposition is expected to remain suspended until repairs of the NTSF wall are completed. In December 2019, Cadia Holdings received approval from the New South Wales Department of Planning and Environment (**NSW DPE**) to fully utilise the decommissioned Cadia Hill mine pit for deposition of dewatered tailings. In December 2021, the NSW DPE granted approval to increase the permitted processing capacity from 32 to 35 million tonnes of ore in a calendar year. Such approval was subject to certain conditions, including that Cadia Holdings commission and publish an independent air quality audit report that includes a description of the details and scheduling of all reasonable and feasible best practice measures that are being implemented by Cadia Holdings to minimise off-site air quality impacts of the mine.

The independent air quality audit report published by Cadia in August 2022 indicated that dust emitted from two ventilation exhaust rises which vent emissions from underground processing operations exceeded levels permitted by applicable law. During the quarter ended June 2023, the New South Wales Environment Protection Authority (**NSW EPA**) issued variations to its Environment Protection Licence (**EPL**), a Prevention Notice and Notices to Provide Information regarding the management of, and investigation into potential breaches relating to, dust emissions and other air pollutants from the Tailings Storage Facilities and ventilation rises. The licence variations largely formalised the actions Cadia had developed in consultation with the NSW EPA and were already undertaking across a range of measures.

Cadia Holdings received a letter from the NSW EPA in June 2023 requiring it to immediately comply with specific statutory requirements and EPL conditions. Adjustments were implemented underground, including a reduction in mining rates, modifications to the ventilation circuit and the installation of additional dust sprays and spray curtains.

In August 2023, the NSW EPA commenced proceedings in the Land and Environment Court of NSW against Cadia Holdings, alleging that air emissions from Cadia in March 2022 exceeded the standard of concentration for total solid particles permitted under applicable laws due to the use of surface exhaust fans at the mine. The NSW EPA's investigation regarding the management of air emissions from the mine is ongoing.

Failure to maintain compliance with applicable law or Cadia Holdings' EPL may result in the NSW EPA suspending or revoking Cadia Holdings' EPL, seeking court orders or issuing additional prevention notices to modify or cease certain activities. Ongoing enforcement, and challenges in maintaining compliance, may impact Cadia Holdings' ability to secure a future expansion of its project approval to extend the life of mine from 2031 to 2055. In addition, Cadia Holdings has previously been, and may in the future be, subject to prosecutions and penalties for noncompliance with air quality requirements or the terms of its EPL, including in respect of emissions from any vent rise or emissions from its NTSF and Southern Tailings Storage Facility (**STSF**). Operational changes required to achieve or maintain compliance, including reductions in mining rates and other limitations on mining or processing operations, or additional requirements to install costly pollution control equipment, may adversely impact Newcrest's operating results and financial condition and/or result in other consequences of the kind described above at the outset of this sub-section 8.4(b)(1).

8.4 Risks relating to the Newcrest Group if the Scheme is not implemented *continued*

C) Environmental Sampling in the Cadia Area

In early 2023, residents living near Cadia raised concerns about potential impacts to drinking water supplies by various contaminants, including metals such as lead, nickel and copper, which they allege are related to emissions from the vent rises at Cadia, as well as periodic dust emission events at NTSF and STSF. In response to community concerns, the New South Wales Ministry of Health tested the quality of residents' kitchen tap water and reported that it was safe to drink. The NSW EPA also undertook water testing in the local area and initial results show that the majority of results from the kitchen tap samples show metal concentrations below the Australian Drinking Water Guidelines values. External experts retained by Newcrest also conducted sampling of more than 100 residential rainwater tanks, the results of which indicated only eight instances in which applicable quality standards were not satisfied. The majority of the instances of non-compliance that were identified are believed to be influenced by building and plumbing materials. A particulate characterisation study, which was undertaken by the Australian government's Australian Nuclear Science Technology Organisation (ANSTO) and commissioned by Cadia Holdings in collaboration with the local community, assessed the PM_{2.5} dust contribution from Cadia to the regional air shed over a 12 month period and concluded that Cadia contributed only a small percentage of soil particulate matter. In fact, soil was determined to be the least significant source of air pollution over the 12 month period, contributing less than 10% to the total PM_{2.5} mass. The ANSTO study also determined that metals of concern recently identified by the community, such as lead, nickel, selenium and chromium, occurred at very low levels in the PM_{2.5} fraction and did not exceed any national standard. The report is part of a comprehensive suite of independent air and water quality investigations, including with respect to sampling of drinking water sources, air quality monitoring, dispersion modelling and lead fingerprinting, that have been or are being conducted to determine the source of metals within the local airshed and to assess any health risks to the local community, if any, from air emissions from the Cadia mine site. In light of these developments at Cadia, there is a heightened level of community concern relating to the perceived impact of mining activities on the health of the community, and the condition of residential properties, located in proximity to Cadia. These developments, including community complaints associated with Newcrest's activities at Cadia could give rise to reputational harm, operational disruptions, increased regulatory scrutiny of mining activities, delays to project development and/or result in other consequences of the kind described above at the outset of this sub-section 8.4(b)(1).

D) New South Wales Parliamentary inquiry

In July 2023, a New South Wales Parliamentary inquiry (Legislative Council's *Portfolio Committee No. 2 – Health*) was commenced into current and potential community impacts of the gold, silver, lead and zinc mining on human health, land, air and water quality in New South Wales. The inquiry process will include written submissions, public hearings and witness testimony. The committee's terms of reference for the inquiry state that the committee will publish a report containing its findings, as well as its non-binding recommendations to the NSW Government, in November 2023. Although it is uncertain at this stage, it is possible that the inquiry's findings may result in new regulation. Newcrest has provided a submission to the committee.

2) Newcrest's operations and projects may be subject to risks related to Newcrest's relationships and/or agreements with local communities and laws for the protection of cultural heritage, which could materially adversely impact Newcrest's operating results and financial condition

Newcrest's relationships with the communities that are located near its operations or on whose land it operates are essential to the success of its existing operations, exploration activities and the construction and development of its projects. A failure to manage relationships with such communities may lead to local dissatisfaction which, in turn, may lead to interruptions to Newcrest's operations, exploration activities and development projects. Specific challenges in community relations include community concerns over management of increased traffic, migratory workforces, environmental impacts and resource depletion, social, environmental and cultural heritage impacts, increasing expectations regarding the level of benefits that communities receive, benefits sharing with Indigenous peoples' governments, concerns focused on the level of transparency regarding the payment of compensation and the provision of other benefits to affected landholders and the wider community. In particular, opposition by Indigenous communities to Newcrest's activities may require modifications to or preclude operation or development of its projects or may require entry into additional agreements with Indigenous communities, which may result in additional costs. Newcrest's current and future operations are subject to a risk that one or more Indigenous communities in the locations in which Newcrest operates may oppose continued operation, further development or new development of its projects or operations. Claims and protests driven by such opposition may disrupt or delay activities, including permitting, at Newcrest's operations and projects.

The negotiation and review of agreements, including components such as business development, participation, co-management and compensation and other benefits, involve complicated and sensitive issues, associated expectations and often competing interests. The nature and subject matter of these negotiations may result in community unrest which, in some instances, may lead to interruptions to Newcrest's exploration programs, operational activities or delays to project implementation or development.

Additionally, the evolving obligations of governments and Indigenous people under international, national and local legislation and international conventions pertaining to the rights of Indigenous people may impact Newcrest's operations and projects. For example, the Government of British Columbia, Canada has adopted the *Declaration on the Rights of Indigenous Peoples Act (2019)* to implement the United Nations Declaration on the Rights of Indigenous Peoples (UNDRIP) in British Columbia, which may impact Red Chris and Brucejack.

8. Risks

8.4 Risks relating to the Newcrest Group if the Scheme is not implemented *continued*

Newcrest is also subject to laws and regulations that provide for the protection and management of cultural heritage in the jurisdictions in which Newcrest operates. For example, following the destruction of Indigenous heritage sites at Juukan Gorge in Western Australia in 2020 and the inquiry and reports issued by the Commonwealth Parliament Joint Standing Committee on Northern Australia in 2021, mining companies have come under heightened scrutiny regarding cultural heritage management, including, for example, with respect to their governance and management processes and procedures around cultural heritage, engagement with Indigenous communities and protection of cultural landscapes. Although the parliamentary inquiry focused on Indigenous cultural heritage, laws to protect and manage cultural heritage also cover non-Indigenous (historic) heritage. Another example, in Western Australia, where Telfer and Havieron, in which Newcrest holds a 70% interest, are located, a new *Aboriginal Cultural Heritage Act 2021 (WA)* came into force in July 2023, replacing the *Aboriginal Heritage Act 1972 (WA)* and introducing new offences and increased penalties aimed at better protecting Aboriginal cultural heritage in Western Australia. On 8 August 2023, the WA Premier announced that the *Aboriginal Cultural Heritage Act 2021 (WA)* will be completely repealed, with an amended *Aboriginal Heritage Act 1972 (WA)* replacing it.

Further, Newcrest's operations could inadvertently disturb protected cultural heritage assets, resulting in international scrutiny by investors and non-governmental organisations, negative impact on shareholder value, compensation and/or offset claims, increased costs to projects and operations, delays impacting construction or production or project development, court action or other legal proceedings and lasting reputational damage.

3) Newcrest's operations at Lihir and Wafi-Golpu in PNG are subject to political and regulatory risks and other uncertainties

Lihir, which comprises an open pit mine that produces gold doré, is located on the island of Aniolum, PNG. Newcrest also holds a 50% interest in a joint venture that owns Wafi-Golpu, which is located in the province of Morobe, PNG. The current PNG administration, led by Prime Minister James Marape, has stated that it wants to increase benefits for PNG from extractive projects. Potential policy changes could include introducing a new production sharing regime for minerals and oil/gas, amending or replacing the PNG Mining Act of 1992, introducing domestic processing/refining requirements, changing the level and manner of local equity participation in projects and introducing new taxation regimes, banking and foreign exchange controls and/or controls pertaining to the holding of cash and remittance of profits and capital to parent companies. Any such change could impact Newcrest's operating results and financial condition.

In 2020, the PNG government prepared and submitted to the National Parliament of PNG (the **PNG Parliament**) a proposed new organic law to introduce a production sharing regime for the mining sector. The proposed organic law will require the approval of a two thirds majority of the PNG Parliament and, if passed in its current proposed form, purports to transfer ownership of minerals from the State of PNG to state-owned entities who would then be responsible for negotiating mineral production sharing arrangements. As currently drafted, the bill containing the proposed organic law will not apply to Lihir, but could potentially apply to Wafi-Golpu if a mining lease or mining development contract is not in place before the effective date for the proposed organic law. Prime Minister Marape has indicated that the law is intended to become effective in 2025. The bill is yet to be debated in the PNG Parliament.

On 29 October 2021, Prime Minister Marape announced proposed legislation which, if enacted, would regulate the export of gold from PNG and require that mining companies operating in PNG refine gold with a new national mint. At this stage, it is unclear whether this proposed legislation will become law and, if so, when it would take effect. In addition, in June 2023, the PNG government released a new national gold bullion policy setting out the government's objective of establishing a domestic gold bullion program to refine gold, hold gold reserves and eventually enter into trading in the world gold market. It is unclear when or how the new national gold bullion policy will be implemented, and how the policy will interact with the legislation proposed in 2021. Under the terms of the Lihir mining development contract, Newcrest may be required to refine a portion of its Lihir gold production within PNG if certain quality and security requirements are met and the terms offered are commercially competitive, but it is otherwise free to enter into arms' length refining contracts with refineries outside of PNG.

The PNG government has also announced that it is considering replacing the current PNG Income Tax Act with a new Income Tax Act (**NITA**) with limited consultation undertaken to date. The latest draft legislation provides that the NITA will come into force from 1 January, 2024. If passed in the current proposed form, the NITA would introduce significant tax uncertainty and potentially adverse tax outcomes for Newcrest. For example, the NITA is incomplete in its current form due to the lack of transitional provisions, key regulations and other key ancillary pieces of legislation. Without these key provisions, it is not clear how existing tax attributes of mining companies would be treated under the NITA, which may have a material adverse effect on Newcrest given the material tax attributes held by Lihir and Wafi-Golpu. The PNG Government has indicated that transitional provisions, regulations and other required legislation will be introduced, but no drafts have been released or made available for public consultation to date. Any adverse changes to income tax laws will affect Lihir because it has no fiscal stability agreement with the PNG government and may also affect Wafi-Golpu depending on the terms of any project agreements that may be entered into with the PNG government.

8.4 Risks relating to the Newcrest Group if the Scheme is not implemented *continued*

There is also the potential for legal challenges to the Wafi-Golpu permitting process as it progresses towards completion, including by PNG provincial governments, landowner groups and civil society organisations. For example, in March 2021 and December 2022, the Governor of Morobe Province and certain residents of the surrounding areas of Wafi-Golpu, respectively, commenced judicial review applications against the State of PNG, challenging the December 2020 grant of the environmental permit for Wafi-Golpu. Both reviews are still to be heard and determined. Any such legal challenges may adversely impact the Wafi-Golpu permitting process. In addition, WGJV is currently engaging with the State of PNG to progress the permitting of Wafi-Golpu and has commenced discussions in relation to its application for a special mining lease, which was submitted to the PNG Mineral Resources Authority in 2016. On 6 April 2023, WGJV signed a Framework Memorandum of Understanding with the State of PNG, which confirmed the parties' intent to proceed with the project at Wafi-Golpu, subject to finalising the permitting process and approvals of the boards of both Newcrest and Harmony Gold, and progress toward signing a mining development contract, which is a prerequisite to granting a special mining lease. The timing for completing the discussions is uncertain and there is no assurance of the outcomes.

Changes in the laws, regulations and policies described above, or to the manner in which they are interpreted or applied to Newcrest, may also adversely impact Newcrest's ability to extend the Lihir special mining lease upon its expiration in 2035. See section 8.4(b)(1) for further information on risks relating to changes in the laws.

4) Newcrest's operations at Red Chris and Brucejack in British Columbia, Canada are subject to political and regulatory risks and other uncertainties

Newcrest holds a 70% interest in the Red Chris operation (**Red Chris**), which comprises an open pit mine that produces gold, copper and silver concentrate, located in British Columbia, Canada. Newcrest's Brucejack operation (**Brucejack**), which comprises an underground mine that produces gold/silver doré and flotation concentrate and hosts the Valley of the Kings high-grade gold deposit, is also located in British Columbia, Canada. In British Columbia, as well as in Canada more generally, the nature and extent of Indigenous rights and title remains the subject of active debate, claims and litigation. First Nations in British Columbia have made claims in respect of Indigenous rights and title to substantial portions of land and water in the province. Some of these claims are made outside of treaty and other processes. The effect of such claims on any particular area of land will not be determinable until the exact nature of historical use, occupancy and rights to such property have been clarified, whether by a decision of the Canadian courts or definition in a treaty or otherwise. First Nations in British Columbia are seeking settlements with respect to these claims, including compensation from governments, and are seeking rights to regulate activities by companies within their traditional territories. The effect of these claims cannot be estimated at this time. The federal and provincial governments in Canada have been seeking to negotiate settlements with respective groups throughout British Columbia in order to resolve many of these claims. Although none of these claims have had material adverse impacts on Red Chris or Brucejack, the issues surrounding Indigenous title and rights remain ongoing.

In addition, the government of British Columbia has adopted the Declaration on the Rights of Indigenous Peoples Act (2019) to implement the UNDRIP in British Columbia. The legislation commits to systematically review the province's laws for alignment with UNDRIP principles, while also encouraging new agreements with Indigenous groups that are intended to address outstanding governance questions around the nature of Indigenous rights and title interests in British Columbia.

On 15 June, 2021, the province of British Columbia was directed to negotiate an agreement with the Tahltan Central Government (**TCG**) of the Tahltan Nation with respect to Red Chris, which agreement would require that decisions under the British Columbia Environmental Assessment Act be exercised either jointly by the province of British Columbia and the TCG or by the province of British Columbia, subject to the prior informed consent of the TCG. Decisions under the British Columbia Environmental Assessment Act will be required for the construction and operation of a block cave mine at Red Chris. A consent agreement or process is not yet in place and the impacts of such an agreement or process on the permitting for the proposed development and operation of the Red Chris block cave mine are therefore currently unknown.

Additionally, several First Nations in British Columbia have recently launched challenges against the constitutionality of the "free entry" mineral staking regime in the province and the government of British Columbia pledged to reform the Mineral Tenure Act, which governs the acquisition and holding of mineral tenures in British Columbia, in consultation with First Nations and First Nation organisations. The impacts of these developments on the acquisition and renewal of mineral tenures in British Columbia are not yet known.

5) Legal proceedings, investigations, regulatory actions and disputes could expose Newcrest to significant liabilities and materially adversely affect its operating results and financial condition

Legal proceedings, investigations, regulatory actions and disputes (including tax audits and disputes) could have a material adverse effect on Newcrest's operating results and financial condition. Newcrest engages in activities that may expose it to legal proceedings, investigations, regulatory actions and disputes in the ordinary course of its business, including in relation to personal injury and wrongful death claims, actual or potential impacts to the environment, labour and landowner disputes, as well as commercial disputes with customers, suppliers and service providers. Newcrest may also be found liable for the wrongful acts or omissions of its contractors or service providers. Additionally, the tax authorities in the jurisdictions in which Newcrest operates could dispute tax positions held by it based on changes in law, jurisprudence, policy or interpretation. Regardless of the ultimate outcome of such proceedings, investigations and disputes, and whether involving regulatory action or civil or criminal claims, there may be a material adverse impact on Newcrest as a result of the associated costs (some of which may not be recoverable) and the impact on management resources.

8. Risks

8.4 Risks relating to the Newcrest Group if the Scheme is not implemented *continued*

Newcrest evaluates the litigation claims and legal proceedings to which it or its businesses are a party to assess the likelihood of unfavourable outcomes and to estimate, if possible, the amount of potential losses. Based on these assessments and estimates, if any, Newcrest establishes provisions and discloses the relevant litigation claims or legal proceedings as appropriate, including in the notes to Newcrest's audited consolidated financial statements as of and for the years ended 30 June 2023, 2022 and 2021, which are prepared in accordance with AAS as issued by the AASB and IFRS as issued by the IASB, and the notes thereto. These assessments and estimates are based on the information available to management at the time and involve significant management judgment. Adverse outcomes in such legal proceedings in excess of the amounts that Newcrest has provided for, or changes in management's evaluations or predictions about the proceedings, could have a material adverse effect on Newcrest's operating results and financial condition.

The New South Wales Resources Regulator is investigating two safety incidents at Cadia, in response to a serious injury that occurred to a team member from one of Cadia's contracting partners in June 2023, and a separate incident resulting in serious injuries to a team member that occurred in October 2021. Newcrest remains committed to learning from these incidents to ensure that safety remains at the forefront of every activity across the business.

6) Newcrest faces geotechnical, geothermal and hydrogeological challenges, which could materially adversely impact Newcrest's operating results and financial condition

Newcrest faces geotechnical, geothermal and hydrogeological challenges, in particular due to a trend toward mining more complex deposits, the use of deeper and larger pits and the use of deep, bulk or selective underground mining techniques. This leads to higher pit walls, more complex underground environments and increased exposure to geotechnical, geothermal and hydrogeological impacts.

There are a number of risks and uncertainties associated with the block cave mining methods applied by Newcrest at Cadia, which is located in New South Wales, Australia. These risks include a cave not propagating as anticipated, excessive air gaps forming during the cave propagation, unplanned ground movement occurring due to changes in stresses released in the surrounding rock and larger or more frequent mining-induced seismicity than anticipated. Additionally, during cave establishment and propagation, higher levels of seismic activity, and higher likelihood of damage to excavations from seismic events, are expected. This has been observed during the cave establishment phase of Cadia's PC2-3 project and is expected during the establishment of Cadia's PC1-2 project in the coming years. Such seismic events and associated damage may require changes to the mining plan and upgrades to ground support systems, which could take several months. Large seismic events may also occur after cave establishment and propagation and during steady state caving, although the likelihood of this is lower. Excessive water ingress, disturbance and the presence of fine materials may also give rise to unplanned releases of material of varying properties and of water through drawbells. Cadia recorded sudden unplanned releases of both dry fine ore material and wet mud material through drawbells during the year ended 30 June 2023.

In addition, there are a number of risks and uncertainties associated with the application of techniques used in the civil engineering industry for the stabilisation of steep open pit slopes by Newcrest at Lihir, which is located in Papua New Guinea. These risks include variation to technical models when compared to actual conditions, performance of reinforcement system in hot ground and delays with the execution of the civil works due to lack of experience with these techniques.

The success of Newcrest's operations depends, in part, on implementing engineering solutions to particular geotechnical, hydrogeological and geothermal conditions. For example, at Newcrest's underground operations, large vertical shafts need to be excavated in order to provide ventilation to the underground environment, and sometimes these shafts are excavated using unsupported techniques such as raiseboring, whereby the walls of the shafts cannot be supported until the excavation is completed. If adverse and unexpected geotechnical and hydrogeological conditions are encountered, the shaft walls may become unstable. To prevent this type of incident occurring, thorough geotechnical and hydrogeological investigations and stability assessments are required and, if needed, alternate excavation locations or techniques need to be implemented. One such shaft wall failure incident occurred at Cadia in July 2022, resulting in the need to abandon and backfill a shaft shortly after the completion of excavation to prevent further unravelling of the shaft wall and potential interruptions to other operations.

In addition, preconditioning techniques need to be implemented at Cadia to reduce the magnitude of large seismic events and reduce the risk associated with airblast. At Cadia and Telfer, ground support systems need to be designed and installed to contain potential energy release that may result from a seismic event. At Cadia, semi-autonomous equipment is used due to the safety risk associated with any unplanned release of material, including mud and dry fine ore, from the drawpoints. Significant removal of both groundwater and sea water inflow and geothermal control is required at Lihir before and during mining. Also at Lihir, equipment with reinforced windows and remote controlled equipment is required to mitigate the impact of geysers and geothermal outburst, and blasting of outburst prone areas is required to reduce frequency and severity of outburst events.

A failure to safely resolve any unexpected problems relating to these conditions at a commercially reasonable cost may result in damage to infrastructure or equipment or injury to personnel and may adversely impact Newcrest's operating results and financial position.

8.4 Risks relating to the Newcrest Group if the Scheme is not implemented *continued*

7) Newcrest's operations may be materially adversely affected by challenges to operating conditions and natural disasters

Some of Newcrest's operations may also experience challenges to operating conditions, such as inundation, inrush of water or other materials, airblast and those relating to elevated temperatures (including management and discharge of hot water encountered in the underground workings). These risks could result in damage to, or destruction of, mineral properties, production facilities, equipment or other properties, personal injury or death of employees or third parties, environmental damage, community outrage, delays in mining, increased production costs, monetary losses and possible legal liability.

Newcrest may also be subject to risks associated with a natural disaster, which include risk of tsunami, wildfires, mine flooding, geysers and outbursts at Lihir, cyclones at Telfer, flooding and drought conditions at Cadia, avalanches at Brucejack and landslides at Red Chris. In addition, seismic activity may impact Newcrest's operations that are located in seismically active areas and subject to risks of earthquakes, such as Cadia and, as regards the related risks of tidal surge and tsunamis, Lihir. For instance, a large seismic event in April 2017 impacted Cadia resulting in a temporary suspension of operations.

Newcrest maintains a range of insurance policies. However, Newcrest's insurance policies do not cover all actual or potential risks associated with its business. Newcrest may also elect not to insure or to self-insure against certain risks in certain circumstances. The occurrence of events for which Newcrest is not insured or for which insurance is inadequate may adversely affect Newcrest's operating results and financial condition.

8) Newcrest's operations involve a high degree of risk, including hazards related to the use of explosives and hazardous chemicals and critical equipment failure

Newcrest's operations are subject to risks associated with the transportation, storage, handling and use of explosives and hazardous chemicals. These include unplanned detonation of explosives and catastrophic release of hazardous chemicals (for example, due to vessel rupture resulting in an explosion or toxic gas release). Critical equipment related risks that apply at all Newcrest sites include for example, mill failure arising from catastrophic failure of a component, or unavailability of mine haul fleet. Other critical equipment related risks may be site specific; for example, impacts on asset integrity at Lihir due to the proximity of the mine to a corrosive marine environment. The occurrence of such catastrophic events may result in work stoppages, damage to or destruction of mines and other producing facilities, damage to or loss of life and property, environmental damage and possible legal liability for any or all damage or loss and may adversely affect Newcrest's operating results and financial condition.

9) Newcrest is subject to a range of climate change risks

Newcrest is subject to a range of climate change risks related to the transition to a lower-carbon economy, including increased climate change-related regulation and requirements, uncertainties regarding the development and availability of low-carbon technologies and the cost of carbon pricing, reputational risks, increased capital costs as well as cost of inputs, energy and raw materials, reduced availability of equipment and raw materials supply and inability to access external funding and insurance. For example, in Australia, as of July 2023, large industrial emitters like Newcrest are subject under the Safeguard Mechanism to progressive regulatory limitations on greenhouse gas (GHGs) emissions at covered facilities, which currently only include Telfer, which require Newcrest to achieve GHG emissions reductions from its operations or to purchase and surrender carbon credits at market prices for GHG emissions above permitted levels. In addition, in British Columbia, Canada, a carbon tax on carbon dioxide or carbon dioxide equivalent emissions applies for operations at Brucejack and Red Chris. Newcrest has completed an initial climate adaptation review for Brucejack, Red Chris, Telfer and Lihir with Cadia planned to commence during FY24.

Newcrest is also subject to physical risks related to climate change, including the increasing frequency and intensity of extreme heat, wildfires, changes in rainfall patterns, flood, snow storms, water scarcity and extreme weather events that may adversely impact Newcrest's operations. Physical risks related to climate change may exacerbate the risks associated with natural disasters that may impact Newcrest, which include risk of tsunami, mine flooding, geysers and outbursts at Lihir, cyclones at Telfer, flooding and drought conditions at Cadia, avalanches at Brucejack and landslides at Red Chris. In particular, the effects of changes in rainfall patterns and intensities, water shortages and changing storm patterns have from time to time adversely impacted, and may in the future adversely impact, the cost, production levels and financial performance of Newcrest's operations. For example, in FY23, Lihir's operating and financial performance was impacted by lower feed grade reflecting a higher proportion of low grade expit material being processed in the second half, following extreme rainfall which limited pit access and caused materials handling issues at the mine crusher. This followed prolonged drought conditions across the province of New Ireland in PNG, in which Lihir is located, which had resulted in limited raw water supply to Lihir. In 2019, Cadia experienced droughts, which resulted in temporary process plant water shortages and lower processed volumes. Floods and wildfires have also occurred near Cadia, Telfer and Red Chris in recent years. Brucejack's glacial access road may be subject to a risk of thawing due to the potential for an increase in average temperatures possibly related to climate change.

In the future, prolonged drought conditions, or insufficient rainfall to support Newcrest's future water demands in relation to its sites and operations, could adversely affect production and its ability to develop or expand projects and operations. Conversely, some of Newcrest's sites and operations have been, and may in the future be, subject from time to time to cyclones, severe storms and high rainfall events leading to periodic interruption of operations, flooding and associated damage. This has resulted, and may in the future result in, delays to or loss of production and development of some of Newcrest's sites, projects or operations.

In May 2021, Newcrest set a goal to achieve net zero carbon emissions by 2050, which relates to its Scope 1 and 2 emissions. This is in addition to Newcrest's announcement in June 2019 of a 30% reduction target for Scope 1 and 2 GHG emissions intensity per tonne of ore milled by 2030 against a 2018 baseline. Any failure or perceived failure by Newcrest to achieve, or accurately report on, its current or future GHG reduction and net zero targets could harm Newcrest's reputation, result in negative investor or community sentiment, and have a material adverse impact on Newcrest's competitive position, operating results and financial condition.

8. Risks

8.4 Risks relating to the Newcrest Group if the Scheme is not implemented *continued*

10) Specific matters relating to the capital expenditure, funding and asset value profile of Newcrest

Newcrest anticipates the continued incurrence of capital expenditures over the next several years in connection with the development of new projects and the expansion of existing projects, including in relation to the development of Havieron, ongoing projects at Cadia including the development of Panel Cave 2-3 and Panel Cave 1-2 and the Life of Mine Tailings Program, the Red Chris Block Cave Project, the Nearshore Soil Barrier and related activities to facilitate mining of the Kapit area of Lihir and a debottlenecking study at Brucejack. Variability in the availability and accessibility of capital and capital costs in connection with such projects may have a material effect on Newcrest's ability to successfully deliver new or expansion projects.

Newcrest has a range of debt facilities including unsecured committed bilateral bank debt facilities and notes and has structured these financing arrangements to have varying maturities so that its refinancing obligations are staggered. In order to satisfy its capital expenditure requirement, Newcrest may from time to time draw down under its available debt facilities or seek additional external funding such as through asset divestitures, further equity or debt issues or additional bank debt, or it may need to defer expenditure.

Newcrest's ability to service its current funding arrangements and to raise and service any additional funding or to meet conditions applicable to current or future funding arrangements is a function of a number of factors, including (without limitation) macroeconomic conditions, funding market conditions, interest rates, future gold and copper prices, Newcrest retaining its investment grade credit rating, Newcrest's operational and financial performance, and cash flow and debt position at the time. Newcrest's ability to access external funding on an efficient basis may be constrained by a dislocation in these markets at the time of planned issuance. If Newcrest is unable to meet its financial obligations or is unable to obtain additional financing on acceptable terms, its operating results and financial condition may be materially adversely affected.

Newcrest has recognised asset impairments, write-downs and restructuring costs in prior reporting periods, and may recognise asset impairments and further write-downs and restructuring costs in the future. Estimates of fair value rely on significant judgments and assumptions. This is particularly relevant in the assessment of long life assets. An adverse change in one of more of the assumptions used to estimate fair value could result in a reduction in fair value.

11) Newcrest is subject to risks relating to the refining, transportation, processing and marketing of gold doré and mineral concentrates

Newcrest's operations produce gold doré, which is delivered to third party refineries for refining into gold and silver bullion. The refining activity is subject to risks such as penalties incurred from delivering gold doré that does not meet the contractual specifications, deficient quality of the refinery process, theft and refinery disruption, including through unplanned outages. Additionally, Newcrest is subject to risks associated with the transportation of gold doré, including fluctuating transportation charges, delays in delivery of shipments, theft, terrorism, geopolitical tensions and border closures and adverse weather conditions.

Newcrest's operations also produce mineral concentrates which are transported by ocean vessels to smelters, located predominantly in Asia. The smelting activity is subject to risks including lower realised prices due to differences between the assay methods used by Newcrest and its customers to determine the value of Newcrest's mineral concentrates, losses during the smelting process, disruption at the operations of smelters and fluctuating smelter charges. Additionally, Newcrest is subject to risks associated with the transportation of mineral concentrates by ocean vessels, including fluctuating transportation charges, delays in delivery of shipments, terrorism, port congestion, loss of or reduced access to export ports, adverse weather conditions, geopolitical tensions and border closures and environmental liabilities in the event of an accident or spill. Further, the quality of mineral concentrates, including the presence of impurities and deleterious substances, is subject to restrictions on import, which vary across jurisdictions, and may impact the ability to sell, or realise the desired price for, the mineral concentrate.

All sales of gold doré and mineral concentrates are subject to analytical specifications contained in Newcrest's sales and refining agreements. The production of gold doré and mineral concentrates is subject to variability in grades due to a number of factors including ore feed variability. The actual specification of gold doré and mineral concentrates may not meet contractual specifications, which may result in adjustments to treatment and refining charges, decreased metals payability or incurrence of impurity penalties with respect to any affected shipment or delivery. These consequences may impact Newcrest's operating results and financial condition in the future.

12) Union activities and labour and employment regulations and matters could materially adversely affect Newcrest's operating results and financial condition

Further to the risk described in section 8.2(j)(1), in a number of jurisdictions where Newcrest has mining and related interests, there are local requirements, contractual obligations and expectations regarding the extent to which local and national persons and businesses are directly engaged in mining and related activities, which may result in disruptions to Newcrest's activities where relevant requirements, obligations or expectations are not met.

Unions are present and/or have a legal right to represent eligible employees at Cadia, which is located in New South Wales, Australia, Telfer, which is located in Western Australia, and Brucejack and Red Chris, which are located in British Columbia, Canada. Red Chris has a unionised workforce and has a collective agreement in place but for one provision, which Newcrest and the union are resolving by way of an arbitration process. There are existing employee enterprise bargaining agreements in place across its Australian operations. In the event that new agreements cannot be reached prior to the nominal expiry of the existing arrangements, under Australian legislation, employees may seek to take protected industrial action. The employee enterprise bargaining agreements pursuant to which the majority of operational employees at Cadia and Telfer are employed will expire in 2025 and 2024, respectively. If protected industrial action is taken, Newcrest's operating results and financial condition could be adversely affected.

This section 9 provides a general summary of certain tax implications that may be applicable to Scheme Shareholders on implementation of the Scheme. This general summary has been prepared for informational purposes only. You should consult your own professional tax adviser regarding the tax implications of participating in the Scheme based on your personal circumstances.

The general summary in this section 9 does not take into account or anticipate changes in the law (by legislation or judicial decision) or practice (by ruling or otherwise) after the Last Practicable Date.

The general summary in this section 9 does not constitute tax advice.

9.1 Australian taxation

a) General

The following is a general summary of the Australian income tax, GST and stamp duty implications expected to arise for certain Scheme Shareholders on implementation of the Scheme. As this summary is necessarily general in nature, Scheme Shareholders should consult with a professional tax adviser regarding their particular circumstances.

This summary only addresses the position of Scheme Shareholders who:

- are registered on the Newcrest Share Register as the holders of Newcrest Shares at the Scheme Record Date;
- hold their Scheme Shares on capital account (that is, not on revenue account or as trading stock);
- have not elected for the taxation of financial arrangements provisions in Division 230 of the *Income Tax Assessment Act 1997* (Cth) (ITAA 1997) to apply in respect of their Scheme Shares;
- are not subject to special tax rules, such as insurance companies, partnerships, tax exempt organisations and entities subject to the investment manager regime under Subdivision 842-1 of the ITAA 1997 in respect of their Newcrest Shares; and
- did not acquire their Scheme Shares under an employee share, option or rights plan.

This Australian taxation section does not address any tax consequences arising under the laws of jurisdictions other than Australia. This section is based on Australian tax laws and regulations, interpretations of such laws and regulations and administrative practice as at the date of this document. The comments in this section are generally directed at Scheme Shareholders who are Australian tax residents (and are not tax residents in any other country), and who acquired, or are taken to have acquired, their Newcrest Shares on or after 20 September 1985. A non-resident Scheme Shareholder should seek their own professional taxation advice.

b) Class Ruling

Newcrest has applied to the Australian Commissioner of Taxation (**Commissioner**) for a Class Ruling. A Class Ruling will only be received from the Commissioner after implementation of the Scheme. It is anticipated that the ATO's views to be expressed in the Class Ruling will be generally consistent with the summary of the key implications set out below. It is possible that the Commissioner may take a different view to the consequences below.

Newcrest expects to receive a draft of the Class Ruling prior to the Scheme Meeting.

c) Disposal of Scheme Shares

The disposal of Scheme Shares by Scheme Shareholders to Newmont Overseas on the Implementation Date will constitute a disposal for capital gains tax (CGT) purposes. If that occurs, Scheme Shareholders will, subject to the comments below on scrip-for-scrip roll-over relief in Section 9.1(d):

- make a capital gain if the capital proceeds from the disposal of their Scheme Shares are greater than the cost base of those Scheme Shares; and
- make a capital loss if the capital proceeds from the disposal of their Scheme Shares are less than the reduced cost base of those Scheme Shares.

The capital proceeds from the disposal of a Scheme Shareholder's Scheme Shares will be equal to the market value of the Scheme Consideration received by them (determined on the Implementation Date). In the circumstances, it is considered that the capital proceeds should not include any Ordinary Course Dividend paid prior to the Implementation Date or the Special Dividend, on the basis that Newmont does not control or fund the payment of these dividends and Scheme Shareholders' entitlement to receive these dividends arises as a result of their relationship with Newcrest (and not Newmont). Consequently, the dividends are not received in respect of the disposal of their Scheme Shares and therefore should not form part of the capital proceeds. Newcrest has sought confirmation of this issue in the Class Ruling.

The cost base (and reduced cost base) of a Scheme Shareholder's Scheme Shares will generally include their original or deemed cost of acquisition, plus certain other costs incurred in relation to the acquisition and disposal of their Scheme Shares such as brokerage fees.

Individuals, complying superannuation entities or trusts may be entitled to reduce the amount of any capital gain made on the disposal of their Scheme Shares if, amongst other things, they have held their Scheme Shares for at least 12 months before the Implementation Date (this reduction is referred to as the **CGT discount**). The CGT discount is applied only after any available capital losses have been applied to reduce the capital gain and is not generally available to companies. The discount rate is 50% for individuals and trusts, or 33⅓% for complying superannuation entities. Capital losses can only be offset against capital gains realised by the Scheme Shareholder in the same income year or in a subsequent income year. Specific loss recoupment rules apply to companies which must be satisfied if those carry forward tax losses are to be used in future years.

9. Tax implications

9.1 Australian taxation *continued*

d) Scrip-for-scrip roll-over relief from CGT

Scrip-for-scrip roll-over relief allows taxpayers to defer a capital gain made by a taxpayer if, under an arrangement, a taxpayer exchanges a share in a company for a share in another company (**Roll-Over Relief**). Newcrest is seeking confirmation that Roll-Over Relief is available for Scheme Shareholders in the Class Ruling. For Scheme Shareholders who exchange their Scheme Shares for Newmont Securities and would otherwise realise a capital gain in respect of the disposal of their Scheme Shares, Roll-Over Relief should be available if they choose to obtain the Roll-Over Relief. Broadly, the consequences of a Scheme Shareholder choosing the Roll-Over Relief will be that:

- the capital gain made upon the disposal of the Scheme Shares will be deferred;
- the first element of cost base and reduced cost base of their replacement Scheme Shares received will be equal to the cost base and reduced cost base (respectively) of the Scheme Share for which it was exchanged; and
- the Scheme Shareholder will be deemed (for CGT discount purposes only) to have acquired their Newmont Securities at the time that they originally acquired, or are deemed to have acquired, their Scheme Shares. This may be relevant for CGT discount purposes in respect of future disposals.

Scheme Shareholders who wish to choose Roll-Over Relief should not include the capital gain from the disposal of their Scheme Shares in their net capital gain calculation for the year in which the Implementation Date occurs. A Scheme Shareholder will provide sufficient evidence of having chosen Roll-Over Relief by the way they prepare their income tax return (i.e. by excluding the disregarded capital gain from assessable income). No formal election is required to be lodged in order to choose to obtain the Roll-Over Relief.

Scheme Shareholders who do not wish to choose Roll-Over Relief should include in their net capital gain calculation for the year in which the Implementation Date occurs the capital gain realised by them on the disposal of their Scheme Shares.

If a Scheme Shareholder would realise a capital loss as a result of disposing of their Scheme Shares under the Scheme, Roll-Over Relief will not be available, and the capital loss will be realised.

e) Australian income tax treatment of any Ordinary Course Dividend or the Special Dividend

Scheme Shareholders who receive any Ordinary Course Dividend and the Special Dividend should include the amounts of those dividends and attached franking credits in their assessable income in the income year in which the dividends are paid. Scheme Shareholders may be entitled to a tax offset equal to the franking credits attached to the Special Dividend.

However, Scheme Shareholders will only be required to include the amount of the franking credits and be entitled to a tax offset for the franking credits if:

- they are 'qualified persons' in relation to the Special Dividend; and
- certain franking integrity rules do not apply.

1) 'Qualified person' rule

In order to be considered a 'qualified person' in relation to any Special Dividend (and assuming there will not be a 'related payment' for the purposes of former Division 1A of the *Income Tax Assessment Act 1936* (Cth) in connection with the Special Dividend – see below), the Scheme Shareholder must have held their Scheme Shares 'at risk' for a continuous period of 45 days (excluding the day of acquisition and the day of disposal) beginning on the day after the Newcrest Shareholder acquired the Newcrest Shares and ending on the 45th day after the relevant Ex-Dividend Date of the dividend).

However, a Scheme Shareholder will not be considered to have held their Scheme Shares 'at risk' where the Scheme Shareholder has materially diminished risk of loss or opportunities for gain in respect of the Scheme Shares. A Scheme Shareholder will be taken to have materially diminished risk if their net position in relation to the Scheme Shares has less than 30% of the risks of loss and opportunities for gain (for example due to hedging transactions). Accordingly, in respect of the Special Dividend, Scheme Shareholders should be qualified persons for the purposes of paragraph 207-145(1)(a) of the ITAA 1997 provided that they hold their Scheme Shares 'at risk' for a continuous period of 45 clear days before the Scheme Record Date.

The Scheme Consideration payable in respect of the transfer of each Scheme Share is not reduced by the amount of any dividends. Newmont will not be involved in the decision-making process or provide any funding to enable the payment of the dividends. Newmont will not be obligated in any way to favour payment of the dividends or to do anything to bring about the result that the dividends will be received by Scheme Shareholders. In addition, the Scheme is not in any way conditional on the dividends being declared and Newmont does not have any right to terminate the Scheme Implementation Deed if Newcrest decides not to declare and pay the dividends. Accordingly, it is considered that the circumstances surrounding the payment of the dividends do not constitute an act that passes the benefit to another person for these purposes. On that basis, it is considered that a Scheme Shareholder will not be taken to have made a related payment in respect of either any Ordinary Course Dividend or the Special Dividend.

9.1 Australian taxation *continued*

2) Franking integrity rules

The franking integrity rules are intended to prevent abuse of the imputation system (for example by streaming franking credits to certain shareholders). The tax rules in this area are complex. As part of the Class Ruling, Newcrest has applied for confirmation from the ATO that certain franking integrity rules should not apply.

Scheme Shareholders should seek independent professional taxation advice regarding the application of the franking integrity rules to their particular circumstances.

3) Entitlement to franking credits in excess of tax liability

Provided that Scheme Shareholders are 'qualified persons' in relation to the Special Dividend and none of the franking integrity measures apply, to the extent that the Scheme Shareholder's entitlement to franking credits exceeds their tax liability for the income year:

- Scheme Shareholders who are Australian resident individuals and complying superannuation funds should be entitled to receive a refund of the excess franking credits; and
- Scheme Shareholders that are Australian resident companies may be able to convert excess franking credits into tax losses and credit their franking account with the amount of the franking credit attached to the Special Dividend.

f) Consequences of holding Newmont Securities

1) Dividends in respect of Newmont Securities

Dividends in respect of Newmont Securities received by an Australian resident Scheme Shareholder will be subject to Australian income tax in the tax year in which they are payable.

The Scheme Shareholder will need to include the amount of the cash received together with any amount withheld by Newmont referable to United States withholding tax. The Scheme Shareholder may be entitled to a foreign income tax offset equal to the amount withheld.

Subject to an Australian resident Scheme Shareholder being entitled to the benefit of the United States/Australia Double Tax Treaty the rate of withholding should be:

- Scheme Shareholders who are a company and directly hold 10% or more of Newmont: 5%; or
- otherwise: 15%.

2) Future disposal of Newmont Securities

A future disposal of Newmont Securities will be a capital gains tax event for an Australian resident Scheme Shareholder, which will result in the Scheme Shareholder realising a capital gain or a capital loss. The amount of that capital gain or capital loss will depend on the Scheme Shareholder's cost base, or reduced cost base, and acquisition date of their Newmont Securities. This, in turn, will depend on whether the Scheme Shareholder chose Roll-Over Relief.

If Roll-Over Relief was available and the Scheme Shareholder chose Roll-Over Relief then:

- the first element of cost base and reduced cost base of their replacement Scheme Shares received will be equal to the cost base and reduced cost base (respectively) of the Scheme Share for which it was exchanged; and
- the Scheme Shareholder will be deemed (for CGT discount purposes only) to have acquired their Newmont Securities at the time that they originally acquired, or are deemed to have acquired, their Scheme Shares.

If Roll-Over Relief was not available or it was but the Scheme Shareholder did not choose Roll-Over Relief then:

- the first element of cost base and reduced cost base of their replacement Scheme Shares received will be equal to the market value of Scheme Shares on the Implementation Date; and
- the date of acquisition for CGT discount purposes of the Newmont Securities will be the Implementation Date.

9. Tax implications

9.1 Australian taxation *continued*

g) Non-residents of Australia

1) Disposal of Newcrest shares

A Scheme Shareholder can disregard a capital gain or capital loss they make from the disposal of their Scheme Shares under the Scheme if the Scheme Shareholder:

- is not a resident of Australia for tax purposes;
- does not hold, and has not held for a period of at least 12 months during the 24 month period up to the Implementation Date, with tax law associates, 10% or more of the Scheme Shares;
- has not, at any time, held their Scheme Shares in carrying on business through a permanent establishment in Australia; and
- has not made an election to treat their Scheme Shares as “taxable Australian property” under section 104-165 of the ITAA 1997 when ceasing to be an Australian resident.

If a non-resident Scheme Shareholder holds, or has held for a period of at least 12 months during the 24 month period up to the Implementation Date, with tax law associates, 10% or more of the Scheme Shares then, subject to the comments below, the non-resident Scheme Shareholder will be subject to Australian capital gains regime if more than 50% of Newcrest’s value is attributable to direct or indirect interests in “taxable Australian real property” (as defined in the ITAA 1997) (being “taxable Australian property” as defined in the ITAA 1997).

If a non-resident Scheme Shareholder cannot disregard their capital gain, Roll-Over Relief will only be available if immediately after they acquire the Scheme Consideration:

- they hold their Newmont Securities in carrying on business through a permanent establishment in Australia; or
- both of the following apply:
 - > they hold, together with their tax law associates, 10% or more of the Newmont Securities; and
 - > more than 50% of Newmont’s value is attributable to direct or indirect interests in “taxable Australian real property” (as defined in the ITAA 1997).

2) Ordinary Course Dividend and Special Dividend

If a Scheme Shareholder is a non-resident of Australia, any Ordinary Course Dividend and Special Dividend they receive should not be subject to income tax in Australia and, to the extent that the Ordinary Course Dividend and Special Dividend is franked, the franked portion should not be subject to Australian dividend withholding tax.

Non-resident Scheme Shareholders should consult with a professional tax adviser regarding their particular circumstances.

3) Foreign resident capital gains withholding tax

If a Scheme Shareholder is a non-resident of Australia, the capital gains withholding tax regime can apply to their Scheme Shares, unless the Scheme Shares are not “taxable Australian property” (as defined in the ITAA 1997).

Newmont Overseas has agreed an approach with the ATO with respect to determining whether the capital gains withholding tax regime should apply to Newcrest Shares held by certain non-resident Scheme Shareholders.

Under that approach, Newmont Overseas, in co-operation with Newcrest, may seek to clarify the status of particular Scheme Shareholders and require these Scheme Shareholders to provide Newmont Overseas with either:

- a Declaration that they are an Australian tax resident or that their Scheme Shares are not an “indirect Australian real property interest” (**Declaration Form**); or
- a notice of variation granted by the ATO varying the amount or rate of tax to be withheld (**Variation Notice**).

Unless a signed Declaration Form or Variation Notice is provided to Newmont for these particular Scheme Shareholders, Newmont may withhold up to 12.5% of the Scheme Consideration payable to the Scheme Shareholder and pay that amount to the Commissioner of Taxation. Newmont has noted to Newcrest that it expects to contact a very limited number of non-resident Scheme Shareholders and that if Newmont does not contact a non-resident Scheme Shareholder then it will not withhold any amount under these provisions.

Non-resident Scheme Shareholders should consult with a professional tax adviser regarding their particular circumstances.

h) GST

GST should not be payable by Scheme Shareholders in relation to their participation in the Scheme or in relation to the receipt of any Special Dividend paid by Newcrest. However, the eligibility for Scheme Shareholders to claim full or partial input tax credits in relation to GST incurred on adviser fees and other costs relating to their participation in the Scheme will depend on the individual circumstances of each shareholder.

i) Stamp duty

Scheme Shareholders should not be liable for any stamp duty in any Australian State or Territory in relation to their participation in the Scheme.

9.2 United States taxation

The following discussion summarises the material United States federal income tax consequences of any Ordinary Course Dividend, the Special Dividend and the receipt of Newmont Securities in exchange for Newcrest Shares pursuant to the Scheme and of the ownership and disposition of Newmont Securities. It is not intended to be a complete analysis or description of all potential United States federal income tax consequences of the Scheme. This discussion is based upon the provisions of the United States Internal Revenue Code of 1986, as amended (the "Code"), the United States Treasury Regulations promulgated thereunder and judicial and administrative rulings, all as in effect as at the date of this Scheme Booklet and all of which are subject to change or varying interpretation, possibly with retroactive effect. Any such changes could affect the accuracy of the statements and conclusions set forth herein. The Internal Revenue Service may not agree with the tax consequences described in this discussion.

This discussion assumes that holders of Newcrest Shares hold their Newcrest Shares as capital assets within the meaning of section 1221 of the Code (generally, property held for investment). This discussion does not address all aspects of United States federal income taxation that may be relevant to a holder of Newcrest Shares in light of such holder's particular circumstances, nor does it discuss the special considerations applicable to holders of Newcrest Shares subject to special treatment under the United States federal income tax laws, such as, for example, financial institutions or broker-dealers, mutual funds, tax-exempt organisations, retirement or other tax-deferred accounts, insurance companies, dealers in securities or non-US currencies, traders in securities who elect the mark-to-market method of accounting, controlled foreign corporations, passive foreign investment companies, holders subject to the alternative minimum tax, holders who hold their Newcrest Shares as part of a hedge, straddle, constructive sale or conversion transaction, US holders (as defined below) whose functional currency is not the US dollar, accrual method holders who prepare an "applicable financial statement" (as defined in section 451 of the Code) and holders who own or have owned (directly, indirectly or constructively) 10% or more of the Newcrest Shares (by vote or value). In addition, this discussion does not address any tax consequences arising under the laws of any state, local or non-US jurisdiction, the application of the Medicare tax on net investment income under section 1411 of the Code, or United States federal non-income tax consequences (for example, the federal estate or gift tax).

If an entity or arrangement treated as a partnership for United States federal income tax purposes holds Newcrest Shares, the tax treatment of a partner in such a partnership generally will depend on the status of the partner and activities of the partnership. If you are a partner of a partnership holding Newcrest Shares, you should consult your own tax adviser.

All holders should consult their own tax adviser to determine the particular tax consequences to them (including the application and effect of any state, local or non-US income and other tax laws) of the receipt of any Ordinary Dividend, the Special Dividend and Newmont Securities in exchange for Newcrest Shares pursuant to the Scheme and of the ownership and disposition of Newmont Securities.

For purposes of this discussion, the term "US holder" means a beneficial owner of Newcrest Shares that is, for United States federal income tax purposes:

- an individual citizen or resident of the United States;
- a corporation (including any entity treated as a corporation for United States federal income tax purposes) created or organised in or under the laws of the United States, any state thereof or the District of Columbia;
- a trust if (1) its administration is subject to the primary supervision of a court within the United States and one or more US persons, within the meaning of section 7701(a)(30) of the Code, have the authority to control all substantial decisions of the trust or (2) it has a valid election in effect under applicable United States Treasury Regulations to be treated as a US person for United States federal income tax purposes; or
- an estate the income of which is subject to United States federal income tax regardless of its source.

A "non-US holder" is a beneficial owner (other than a partnership or an entity classified as a partnership for United States federal income tax purposes) of Newcrest Shares that is not a US holder.

In general, for United States federal income tax purposes, a holder of Newmont CDIs or Newmont PDIs will be treated as the beneficial owner of the underlying Newmont Shares represented by the CDIs or PDIs.

Holders that are Ineligible Foreign Shareholders generally will be treated as having received Newmont Shares in exchange for Newcrest Shares pursuant to the Scheme (which will be taxed as described below under "—Material United States Federal Income Tax Consequences to US Holders—Consequences of the Scheme" or "—Material United States Federal Income Tax Consequences to Non-US Holders—Consequences of the Scheme", as applicable) and then having received cash in Australian dollars in exchange for such Newmont Shares (which will be taxed as described below under "—Material United States Federal Income Tax Consequences to US Holders—Consequences of Holding and Disposing of Newmont Securities—Sale or Other Taxable Disposition" or "—Material United States Federal Income Tax Consequences to Non-US Holders—Consequences of Holding and Disposing of Newmont Securities—Sale or Other Taxable Disposition").

9. Tax implications

9.2 United States taxation *continued*

a) Material United States Federal Income Tax Consequences to US Holders

1) Consequences of the Scheme

A) Receipt of Scheme Consideration in General

Although the matter is not free from doubt, Newcrest expects that the receipt of Newmont Securities in exchange for Newcrest Shares will be treated as a taxable transaction for United States federal income tax purposes. The remainder of this discussion assumes that the transaction will be so treated.

Subject to the application of the passive foreign investment company rules, discussed below, a US holder generally will recognise gain or loss for United States federal income tax purposes equal to the difference, if any, between (i) the sum of the fair market value of the Newmont Securities received pursuant to the Scheme and (ii) such US holder's adjusted tax basis in the Newcrest Shares surrendered in exchange therefor, as applicable. A US holder's adjusted tax basis in the Newcrest Shares generally will be the US holder's US dollar value of the amount paid to purchase the Newcrest Shares (i.e., the fair market value of such Newcrest Shares) on the date of purchase. The deductibility of capital losses is subject to limitations.

If Newcrest neither is, nor has been, a PFIC (as defined below) for any taxable year during which a US holder held Newcrest Shares, such gain or loss generally will be capital gain or loss and will be long-term capital gain or loss if the holder's holding period for such Newcrest Shares exceeds one year as at the date of the Scheme. If a US holder acquired different blocks of Newcrest Shares at different times or at different prices, such US holder must determine its tax basis, holding period, and gain or loss separately with respect to each block of Newcrest Shares. Any gain or loss realised on disposition of Newcrest Shares generally will be treated as arising from US sources.

A US holder's tax basis in the Newmont Securities received in the Scheme will equal the Newmont Securities' fair market value as at the Implementation Date. A US holder's holding period for the Newmont Securities received in the Scheme will begin on the day following the Effective Time.

Australian taxes withheld or otherwise payable on the receipt of Newmont Securities in exchange for Newcrest Shares may be eligible for a credit against a US holder's United States federal income tax liability. The rules governing foreign tax credits are complex and US holders are urged to consult their tax advisers regarding the creditability of foreign taxes in their particular circumstances. In lieu of claiming a foreign tax credit, a US holder may deduct foreign tax in computing their taxable income, subject to generally applicable limitations under United States law. An election to deduct foreign taxes instead of claiming foreign tax credits applies to all foreign taxes paid or accrued in the taxable year.

B) Receipt of Ordinary Dividend and Special Dividend

Although the matter is not free from doubt, Newcrest expects that the Ordinary Dividend and Special Dividend will be treated as a taxable distribution by Newcrest for United States federal income tax purposes. In general, a distribution by Newcrest will constitute a dividend for United States federal income tax purposes to the extent of Newcrest's current or accumulated earnings and profits as determined for United States federal income tax purposes. Any distribution not constituting a dividend for United States federal income tax purposes will be treated as first reducing the adjusted basis in the US holder's Newcrest Shares and, to the extent it exceeds such adjusted basis, as gain from the sale or exchange of such Newcrest Shares. Any such dividend income generally will be foreign source income. Because Newcrest is not a United States corporation, dividend income recognised by a corporate US holder generally will not be eligible for the dividends-received deduction.

To the extent the Ordinary Dividend and Special Dividend are treated as a dividend for United States federal income tax purposes, they generally will be treated as a "qualified dividend" eligible for reduced rates of taxation if (i) Newcrest is eligible for benefits under an applicable tax treaty with the United States and (ii) Newcrest was not, in the year prior to the Ordinary Dividend and Special Dividend, and is not, in the year of the Ordinary Dividend and Special Dividend, a PFIC (as defined below). Newcrest believes that it is eligible for benefits under an applicable tax treaty between the United States and Australia.

The amount of any dividend distribution paid in a non-US currency will be the US dollar amount calculated by reference to the exchange rate in effect on the date of actual or constructive receipt, regardless of whether the payment is in fact converted into US dollars at that time.

A US holder may have foreign currency gain or loss if the dividend is converted into US dollars after the date of receipt.

C) Passive Foreign Investment Company Rules

A non-US corporation, such as Newcrest, is generally classified as a "passive foreign investment company" (**PFIC**) for any taxable year if, after the application of certain "look-through" rules, (a) at least 75% of its gross income is "passive income" as that term is defined in the relevant provisions of the Code (for example, dividends, interest, royalties, or gains on the disposition of certain property), or (b) at least 50% of the average value of its assets consists of assets that produce, or are held for the production of, "passive income". The determination of whether any non-US corporation is a PFIC for any taxable year is a fact-intensive determination and depends on the application of complex United States federal income tax rules, which are subject to differing interpretations and may change.

Newcrest has not undertaken detailed calculations in relation to its PFIC status. However, based on high level projections, Newcrest believes that it was not a PFIC during any taxable year prior to the taxable year ended 30 June 2023 and does not expect that it will be a PFIC through the taxable year that includes the Implementation Date (however, there can be no assurance that the United States Internal Revenue Service will not successfully challenge this position). Whether Newcrest is a PFIC for a particular taxable year is a factual determination made annually after the close of that taxable year.

9.2 United States taxation *continued*

This determination is fact intensive and also depends in part on the application of the “active commodities exception” for income derived in commodities transactions to treat income from certain of Newcrest’s activities as income that is not “passive income” under the PFIC rules. The availability of the active commodities exception under the PFIC rules and its application to Newcrest is uncertain. There can be no assurance that the United States Internal Revenue Service will not successfully challenge the position that the exception is available under the PFIC rules or its application to Newcrest.

US holders should consult their own tax advisers regarding the tax consequences applicable to them with respect to this Scheme, including the likely treatment of Newcrest as a PFIC and the effective date of the United States Treasury Regulations discussed above.

If Newcrest is or has been a PFIC for any taxable year during which a US holder held Newcrest Shares, such US holder generally will be subject to special rules with respect to any gain recognised on the receipt of Newmont Securities pursuant to the Scheme, which could result in adverse tax consequences to such US holder. Under these special rules, any gain will generally be allocated ratably over the US holder’s holding period for the Newcrest Shares. The amount of gain allocated to the taxable year in which the Scheme is implemented, and any taxable year prior to the first taxable year in which Newcrest became a PFIC, will be treated as ordinary income for the taxable year in which the Scheme is implemented. The amount allocated to each other year will be subject to the highest tax rate in effect for that year and the interest charge generally applicable to underpayments of tax will be imposed on the resulting tax attributable to each such year.

A US holder that owns an equity interest in a PFIC may have to file an Internal Revenue Service Form 8621 and such other information as may be required by the United States Treasury Department.

The rules dealing with PFICs are very complex and affected by various factors in addition to those described above. Accordingly, US holders are strongly urged to contact their own tax advisers regarding Newcrest’s likely status as a PFIC for any taxable year in which such US holder held Newcrest Shares and the application of the PFIC rules in light of such US holder’s particular circumstances (which may result in different tax consequences from the above), including the applicability of any exceptions, and certain elections (e.g. “mark-to-market” election or “qualified electing fund” election).

2) Consequences of Holding and Disposing of Newmont Securities

A) Distributions

Distributions with respect to Newmont Securities will be treated as a dividend to US holders to the extent that they are paid out of Newmont’s current or accumulated earnings and profits, as determined under United States federal income tax principles. To the extent that the amount of any distribution exceeds Newmont’s current and accumulated earnings and profits for a taxable year, the excess will first be treated as a tax-free return of capital, causing a reduction in the US holder’s adjusted tax basis in such US holder’s Newmont’s Securities. The balance of the excess, if any, will be treated as gain from the sale of such US holder’s Newmont Securities, as described below under “Sale or Other Taxable Disposition”.

If a US holder is an individual, dividends received by such holder may be subject to a reduced maximum tax rate provided that certain holding period and other requirements are met. US holders should consult their own tax advisers regarding the availability of such reduced tax rate.

B) Sale or Other Taxable Disposition

A US holder will generally recognise capital gain or loss on a sale or other taxable disposition of Newmont Securities. The US holder’s gain or loss will equal the difference between the amount realised by the US holder and the US holder’s adjusted tax basis in the Newmont Securities. The amount realised by the US holder will include the amount of any cash and the fair market value of any other property received for the Newmont Securities. Gain or loss recognised by a US holder on a sale or other taxable disposition of Newmont Securities will be long-term capital gain or loss if the US Holder’s holding period in the Newmont Securities is more than one year at the time of the sale, exchange or other taxable disposition. Long-term capital gains for certain non-corporate US holders, including individuals, are currently generally eligible for a reduced rate of United States federal income taxation. The deductibility of capital losses is subject to limitations.

b) Material United States Federal Income Tax Consequences to Non-US Holders

1) Consequences of the Scheme

Subject to the discussion below under “Information Reporting and Backup Withholding,” any gain recognised on the receipt of Newmont Securities pursuant to the Scheme by a non-US holder and any income recognised on the Ordinary Dividend and Special Dividend generally will not be subject to United States federal income tax unless:

- the gain is effectively connected with a United States trade or business of such non-US holder (and, if required by an applicable income tax treaty, is also attributable to a permanent establishment or, in the case of an individual, a fixed base in the United States maintained by such non-US holder), in which case the non-US holder generally will be subject to tax on such gain in the same manner as a US holder and, if the non-US holder is a non-US corporation, such corporation may be subject to branch profits tax at the rate of 30% on the effectively connected gain (or such lower rate as may be specified by an applicable income tax treaty); or
- the non-US holder is a non-resident alien individual who is present in the United States for 183 days or more in the taxable year of the Scheme and certain other conditions are met, in which case the non-US holder generally will be subject to tax at a 30% rate (or a lower applicable income tax treaty rate) on any such gain (other than gain effectively connected with a United States trade or business).

Non-US holders should consult their own tax advisers as to the particular United States federal income tax consequences of the Scheme to them.

9. Tax implications

9.2 United States taxation *continued*

2) Consequences of Holding and Disposing of Newmont Securities

A) Distributions

Distributions with respect to Newmont Securities will be treated as a dividend to non-US holders to the extent that they are paid out of Newmont's current or accumulated earnings and profits, as determined under United States federal income tax principles. To the extent that the amount of any distribution exceeds Newmont's current and accumulated earnings and profits for a taxable year, the excess will first be treated as a tax-free return of capital, causing a reduction in the non-US holder's adjusted tax basis in such non-US holder's Newmont Securities. The balance of the excess, if any, will be treated as gain from the sale of such non-US holder's Newmont Securities, as described below under "Sale or Other Taxable Disposition".

Dividends paid to a non-US holder generally will be subject to United States federal withholding tax at a 30% rate, or a reduced rate specified by an applicable income tax treaty, subject to the discussion below under "FATCA Withholding". To obtain a reduced rate of withholding under an applicable income tax treaty, a non-US holder generally will be required to provide a properly executed Internal Revenue Service Form W-8BEN or Internal Revenue Service Form W-8BEN-E, as applicable, certifying its entitlement to benefits under the income tax treaty.

Dividends paid to a non-US holder that are effectively connected with a United States trade or business of such non-US holder (and, if required by an applicable income tax treaty, are also attributable to a permanent establishment or, in the case of an individual, a fixed base in the United States maintained by such non-US holder) will not be subject to United States federal withholding tax if the non-US holder provides a properly executed Internal Revenue Service Form W-8ECI. Instead, the non-US holder will generally be subject to tax on such income in the same manner as a US holder and, if the non-US holder is a non-US corporation, such corporation may be subject to branch profits tax at the rate of 30% on the effectively connected gain (or such lower rate as may be specified by an applicable income tax treaty).

A non-US holder eligible for a reduced rate of United States federal withholding tax pursuant to an income tax treaty may obtain a refund of any excess amounts withheld by timely filing an appropriate claim for refund with the Internal Revenue Service.

B) Sale or Other taxable Disposition

Subject to the discussion below under "Information Reporting and Backup Withholding", a non-US holder generally will not be subject to United States federal income tax on gain realised on a sale or other taxable disposition of Newmont Securities unless:

- the gain is effectively connected with a United States trade or business of such non-US holder (and, if required by an applicable income tax treaty, is also attributable to a permanent establishment or, in the case of an individual, a fixed base in the United States maintained by such non-US holder), in which case the non-US holder generally will be subject to tax on such gain in the same manner as effectively connected dividend income as described above;
- the non-US holder is a non-resident alien individual who is present in the United States for 183 days or more in the taxable year of disposition and certain other conditions are met, in which case the non-US holder generally will be subject to tax at a 30% rate (or a lower applicable income tax treaty rate) on any such gain (other than gain effectively connected with a United States trade or business); or
- Newmont is or has been a "United States real property holding corporation" (as described below) at any time within the five-year period preceding the disposition or the non-US holder's holding period, whichever period is shorter, and either (a) Newmont Shares are not regularly traded on an established securities market or (b) the non-US holder has owned or is deemed to have owned, at any time within the five-year period preceding the disposition or the non-US holder's holding period, whichever period is shorter, more than 5% of Newmont Shares.

Newmont would be a United States real property holding corporation if at any time the fair market value of Newmont's "United States real property interests", as defined in the Code and applicable United States Treasury Regulations, equals or exceeds 50% of the aggregate fair market value of Newmont's worldwide real property interests and Newmont's other assets used or held for use in a trade or business (all as determined for United States federal income tax purposes). Newmont believes that, at the time of the Scheme, it will not be a United States real property holding corporation, and it does not anticipate that it will become a United States real property holding corporation in the foreseeable future.

Non-US holders should consult their own tax advisers as to the particular United States federal income tax consequences of the Scheme to them.

9.2 United States taxation *continued*

c) Information Reporting and Backup Withholding

Holders may, under certain circumstances, be subject to information reporting and backup withholding (currently at a rate of 24%) with respect to the receipt of Newmont Securities in exchange for Newcrest Shares, any dividends paid with respect to Newmont Securities and any proceeds received on the disposition of Newmont Securities, in each case unless such holder properly establishes an exemption (including by establishing its status as a non-US holder) or provides its correct taxpayer identification number and otherwise complies with the applicable requirements of the backup withholding rules. Backup withholding is not an additional tax. Any amounts withheld under the backup withholding rules can be refunded or credited against a holder's United States federal income tax liability, if any, provided that such holder furnishes the required information to the Internal Revenue Service in a timely manner.

Holders should consult their own tax advisers regarding the information reporting and backup withholding requirements in connection with their receipt of Newmont Securities and ongoing ownership of Newmont Securities.

d) FATCA Withholding

Under sections 1471 through 1474 of the Code (such sections commonly referred to as the Foreign Account Tax Compliance Act, or "FATCA"), payments of dividends on Newmont Securities paid to (a) a "foreign financial institution" (as specifically defined in the Code) or (b) a "non-financial foreign entity" (as specifically defined in the Code) will be subject to a withholding tax (separate and apart from, but without duplication of, the withholding tax described above) at a rate of 30%, unless various United States information reporting and due diligence requirements (generally relating to ownership by United States persons of interests in or accounts with those entities) have been satisfied or an exemption from these rules applies. An intergovernmental agreement between the United States and an applicable foreign country may modify these requirements. If a dividend payment is both subject to withholding under FATCA and subject to the withholding tax discussed above under "Material United States Federal Income Tax Consequences to Non-US Holders—Consequences of Holding and Disposing of Newmont Securities—Distributions", the withholding under FATCA may be credited against, and therefore reduce, such other withholding tax. Non-US holders are urged to consult their own tax advisers regarding how FATCA may apply to them as a result of the receipt of the Scheme Consideration and their ongoing ownership of Newmont Securities.

THE PRECEDING DISCUSSION OF UNITED STATES FEDERAL INCOME TAX CONSIDERATIONS IS FOR GENERAL INFORMATION ONLY AND IS NOT LEGAL OR TAX ADVICE. EACH HOLDER IS ENCOURAGED TO CONSULT ITS OWN TAX ADVISOR AS TO PARTICULAR TAX CONSEQUENCES RELATING TO THE ARRANGEMENT, INCLUDING THE APPLICABILITY AND EFFECT OF ANY UNITED STATES FEDERAL, STATE, LOCAL OR FOREIGN TAX LAWS.

9.3 United Kingdom taxation

The following is a general summary of the United Kingdom tax implications of the Scheme for Scheme Shareholders who are residents of the United Kingdom for United Kingdom tax purposes (**UK Scheme Shareholders**) and who hold their Newcrest Shares, and will hold their Newmont Securities, beneficially as an investment. It is intended as a general guide only and does not constitute legal or tax advice. Scheme Shareholders who may be subject to United Kingdom taxation should consult their own professional advisers as to the United Kingdom tax implications of the Scheme in their particular circumstances.

The following description has been prepared on the basis of United Kingdom taxation law and published practice of the United Kingdom tax authority as at the date of this Scheme Booklet, both of which are subject to change, possibly with retrospective effect.

The description below does not deal with and, therefore, does not apply to certain categories of UK Scheme Shareholders such as (but not limited to) dealers in securities, brokers, trustees, financial institutions, insurance companies, pension schemes, collective investment schemes, persons subject to United Kingdom tax on the remittance basis, persons who hold their investments in any arrangement or scheme approved by the United Kingdom tax authority, persons connected to Newcrest, Newmont or Newmont Overseas or to any member of the Newcrest Group or the Newmont Group, persons who have been or could be treated for tax purposes as having acquired their Newmont Securities by reason of their employment or as holding them as carried interest, and any other persons subject to specific tax regimes or benefiting from special reliefs and exemptions.

9. Tax implications

9.3 United Kingdom taxation *continued*

a) United Kingdom taxation of chargeable gains

1) Consequences of the receipt of Newmont Securities in exchange for Newcrest Shares

The receipt of Newmont Securities in exchange for Newcrest Shares should be treated as a 'disposal' for the purposes of United Kingdom taxation of chargeable gains (**UK CGT**) (with the consequences described below), unless the transaction qualifies for relief (**UK roll-over relief**) by virtue of the share for share exchange provisions in the United Kingdom Taxation of Chargeable Gains Act 1992. While Newcrest considers that UK roll-over relief will not apply, in the circumstances of this exchange transaction UK Scheme Shareholders are encouraged to obtain their own independent taxation advice as to whether, in the specific circumstances of the Scheme, UK roll-over relief may be available (and, if so, the consequences of UK roll-over relief applying). Newcrest further notes that it is possible to apply for a clearance from HMRC that certain anti avoidance legislation will not be applied to deny UK roll-over relief treatment in circumstances where otherwise the conditions for such relief may be satisfied. It is not Newcrest's intention to seek such a clearance.

The remaining paragraphs of this clause 9.3(a)(1) below summarise the expected UK CGT consequences for UK Scheme Shareholders where UK roll-over relief is not available and the transfer of Newcrest Shares under the Scheme is treated as a disposal.

A transfer of Newcrest Shares under the Scheme which is treated as a disposal may, depending on the particular circumstances of the relevant UK Scheme Shareholder (including their base cost in their Newcrest Shares and any available exemption or relief), give rise to a chargeable gain (or an allowable loss) for UK CGT purposes.

Any chargeable gain (or allowable loss) will be calculated as the difference between:

- the value of the consideration received for the Newcrest Shares (that is, the value of the Newmont Securities received in return for the Newcrest Shares); and
- any allowable costs and expenses, including the cost to the UK Scheme Shareholder of originally acquiring the Newcrest Shares.

Neither the value of any Ordinary Course Dividend received by UK Scheme Shareholders in respect of their Newcrest Shares prior to the Implementation Date nor the value of any Special Dividend received by UK Scheme Shareholders in respect of their Newcrest Shares after the Scheme has become Effective should be part of the chargeable gain (or allowable loss) realised on the disposal by UK Scheme Shareholders of their Newcrest Shares.

Chargeable gains arising to a UK Scheme Shareholder who is an individual will be subject to United Kingdom capital gains tax at a rate of either 10% or 20% depending on the individual's total amount of taxable income and chargeable gains for the relevant tax year, subject to the availability of any relief, exemption or allowable losses. The chargeable gains annual exempt amount (which is £6,000 for the tax year running from 6 April 2023 to 5 April 2024 (the **2023/24 UK tax year**)) may be available to reduce the amount of chargeable gains realised by an individual UK Scheme Shareholder (but not to create or increase any loss), to the extent the exemption is not otherwise utilised.

For a UK Scheme Shareholder within the charge to United Kingdom corporation tax, any chargeable gain arising on the disposal of their Newcrest Shares will be subject to corporation tax, subject to the availability of any relief, exemption or allowable losses. Indexation allowance may be available to reduce the amount of chargeable gains realised (but not to create or increase any loss). Indexation allowance is designed to eliminate the effect of inflation on a chargeable gain. However, this was removed with effect from 1 January 2018 such that it is only available for shares held since a date prior to 1 January 2018.

Scheme Shareholders who are not residents of the United Kingdom should not be subject to United Kingdom tax on a gain arising on a disposal of Newcrest Shares unless:

- they carry on a trade, profession or vocation in the United Kingdom through a branch, agency or permanent establishment and, broadly, hold Newcrest Shares for the purposes of the trade, profession, vocation, branch, agency or permanent establishment; or
- they fall within the anti-avoidance rules applying to individuals who are temporarily not resident in the United Kingdom.

2) Consequences of a future disposal of the Newmont Securities by UK Scheme Shareholders

A future disposal of Newmont Securities by a UK Scheme Shareholder may, depending on the particular circumstances of the holder (including any available exemption or relief), give rise to a chargeable gain (or an allowable loss) for UK CGT purposes.

Chargeable gains arising to a UK Scheme Shareholder who is an individual will be subject to United Kingdom capital gains tax at a rate of either 10% or 20% depending on the individual's total taxable income and chargeable gains for the relevant tax year, subject to the availability of any relief, exemption or allowable losses (including the annual exempt amount mentioned in clause 9.3(a)(1) above).

For a UK Scheme Shareholder within the charge to United Kingdom corporation tax, any chargeable gain arising on the disposal of their Newmont Securities will be subject to corporation tax, subject to the availability of any relief, exemption or allowable losses (including the indexation allowance mentioned in clause 9.3(a)(1) above).

Scheme Shareholders who are not residents of the United Kingdom should not be subject to United Kingdom tax on a gain arising on a disposal of Newmont Securities unless:

- they carry on a trade, profession or vocation in the United Kingdom through a branch, agency or permanent establishment and, broadly, hold Newmont Securities for the purposes of the trade, profession, vocation, branch, agency or permanent establishment; or
- they fall within the anti-avoidance rules applying to individuals who are temporarily not resident in the United Kingdom.



9.3 United Kingdom taxation *continued*

b) Stamp duty reserve tax (SDRT) and stamp duty

1) Transfers of or agreements to transfer the Newcrest Shares to Newmont Overseas

No SDRT or stamp duty should be payable by UK Scheme Shareholders on the transfer of, or the agreement to transfer, their Newcrest Shares to Newmont Overseas.

2) Initial issue of Newmont Securities

No charge to SDRT or stamp duty should arise on the issue of Newmont Shares to UK Scheme Shareholders directly or the issue of Newmont Shares to CDN or PDN for CDN or PDN to hold on trust for, and issue Newmont CDIs or Newmont PDIs (respectively) to, UK Scheme Shareholders.

c) Dividends in respect of Newcrest Shares and Newmont Securities

Dividends received by UK Scheme Shareholders in respect of their Newcrest Shares (including any Ordinary Course Dividend and Newcrest Special Dividend) and in respect of their Newmont Securities will be subject to United Kingdom tax, subject to the availability of any relief or exemption.

Dividends received by an individual UK Scheme Shareholder will be subject to United Kingdom income tax in the tax year in which they are payable. To the extent dividends received (in aggregate) in any given tax year fall within the dividend allowance, they will be exempt from United Kingdom income tax. The dividend allowance for the 2023/24 United Kingdom tax year is £1,000 and the dividend allowance for the 2024/25 United Kingdom tax year will be £500.

To the extent dividends received (in aggregate) in any given tax year exceed the dividend allowance, they will be subject to United Kingdom income tax. The applicable rates of income tax for the 2023/24 United Kingdom tax year are:

- 8.75% for basic rate United Kingdom taxpayers;
- 33.75% for higher rate United Kingdom taxpayers; and
- 39.35% for additional rate United Kingdom taxpayers.

In determining whether and, if so, to what extent dividend income falls above or below the threshold for the higher rate of income tax or, as the case may be, the additional rate of income tax, the shareholder's total taxable dividend income for the tax year in question (including the part subject to the dividend allowance) will be treated as the highest part of the shareholder's total income for income tax purposes. In addition, dividends within the dividend allowance which would otherwise have fallen within the basic or higher rate bands will use up those bands respectively and so will be taken into account in determining whether the threshold for higher rate or additional rate income tax is exceeded.

UK Scheme Shareholders who are subject to United Kingdom corporation tax will be subject to corporation tax on dividends, unless (subject to special rules for shareholders that are small companies) the dividends fall within an exempt class and certain other conditions are met.

No United Kingdom income tax should be withheld on the payment of dividends.

10. Comparison of relevant Australian and United States laws

10.1 Background

Newcrest is a public company limited by shares and registered in Victoria under Australian law. Newcrest Shares are listed on the ASX, PNGX and TSX. Newcrest also has an ADR program.

Newmont is incorporated in the United States, under the laws of the State of Delaware. Newmont shares are listed on NYSE and TSX.

If the Scheme is implemented, the rights of Newcrest Shareholders in respect of Newmont Securities will be primarily governed by DGCL, United States federal securities laws, NYSE listing standards and the Newmont Certificate of Incorporation and constituent documents.

In addition, Newmont will apply for admission to:

- the ASX Official List as a Foreign Exempt Listing, subject to customary conditions and the Scheme becoming Effective. Once Newmont is listed on the ASX as a Foreign Exempt Listing, Newmont will be exempt from complying with most of the ASX Listing Rules. However, Newmont will be subject to some requirements of the ASX Listing Rules (see section 7.8(e) for more information); and
- the Official List of PNGX as an Exempt Issuer Listing, subject to customary conditions and the Scheme becoming Effective. Once Newmont is listed on the PNGX as an Exempt Issuer Listing, Newmont will be exempt from complying with most of the PNGX Listing Rules. However, Newmont will be subject to some requirements of the PNGX Listing Rules (see section 11.6 for more information).

A comparison of some of the material provisions of Australian law and Delaware law as they relate to Newcrest and Newmont respectively is set out in this section 10, along with a description of certain securities laws and stock exchange rules where applicable.

References to Australian law where they appear in this section 10 are references to the Corporations Act, ASX Listing Rules, ASX Settlement Operating Rules and Australian common law, as applicable.

The terms of Newmont's certificate of incorporation and by-laws and Delaware law are more detailed than the general information provided below. As such, you should only rely on the actual provisions of those documents and laws. If you would like to read Newmont's certificate of incorporation or by-laws, these documents are filed with the SEC.

The comparison below is not an exhaustive statement of all relevant laws, rules and regulations and is intended as a general guide only. You should seek your own independent professional legal advice if you require further information.

10.2 Comparison of laws

	Newcrest	Newmont
Shareholder meetings <i>Requirement for annual meetings; ability to call general meetings</i>	<p>Under Australian law, the annual general meeting of Newcrest is required to be held at least once in each calendar year, and within five months after the end of its financial year.</p> <p>A general meeting of Newcrest Shareholders may be called in the following circumstances:</p> <ul style="list-style-type: none">– by the Newcrest Board or individual Newcrest Directors from time to time;– when requested to do so by Newcrest Shareholders holding at least 5% of the votes that may be cast at the meeting, Newcrest Directors must call a general meeting within 21 days after the request is given to Newcrest, and the meeting must be held not later than two months after the request is given; or– alternatively, Newcrest Shareholders holding at least 5% of the votes that may be cast at the meeting may themselves call, and arrange to hold, a general meeting of Newcrest.	<p>Newmont is required by NYSE Listing Rules to hold an annual stockholders' meeting during each fiscal year.</p> <p>Under the DGCL, upon application by a Newmont Director or a Newmont Stockholder, the Delaware Court of Chancery may summarily order an annual meeting if there has been no annual meeting (and no action by written consent to elect directors) for 30 days after the date designated for the annual meeting, or if no date for an annual meeting has been designated, for 13 months after the latest of the corporation's incorporation or last annual meeting (or last action by written consent to elect directors).</p> <p>Under Newmont's by-laws, special meetings of Newmont Stockholders:</p> <ul style="list-style-type: none">– may be called by the Newmont Board or by the chair of the Newmont Board or by the Newmont chief executive officer and chair of the Newmont Board; and– shall be called by the chair of the Newmont Board, the Newmont Chief Executive Officer or the Newmont Secretary, upon a written request stating the purposes of the requested meeting and signed by:<ul style="list-style-type: none">> a majority of the Newmont Board; or> Newmont Stockholders owning 25% of the stock of Newmont entitled to vote at such meeting.
Shareholder meetings <i>Notice of meeting</i>	<p>As Newcrest is listed on the ASX, a notice of general meeting of Newcrest must be given at least 28 days before the date of meeting. Newcrest is required to give notice only to Newcrest Shareholders entitled to vote at the meeting, as well as Newcrest Directors and Newcrest's auditor(s).</p>	<p>Newmont's by-laws provide that written notice of a stockholders' meeting must be given not less than 10 days nor more than 60 days before the meeting to each Newmont Stockholder entitled to vote at such meeting. The notice must state the time, place and purpose, and, in the case of a special meeting, must describe any business to be conducted at such meeting.</p>

10.2 Comparison of laws *continued*

	Newcrest	Newmont
Shareholder meetings <i>Quorum requirements</i>	<p>The quorum for a meeting under the Newcrest constitution is five Newcrest Shareholders. If within 15 minutes after the time appointed for a meeting, a quorum is not present, the meeting is dissolved unless the Newcrest Directors adjourn the meeting to a date, time and place determined by them.</p> <p>If no quorum is present at any adjourned meeting within 15 minutes after the time for the meeting, the meeting is dissolved.</p>	<p>Newmont's by-laws provide that except as otherwise provided by any applicable law or its certificate of incorporation, the holders of record of a majority of the capital stock of Newmont issued and outstanding and entitled to vote at any meeting of its stockholders are required to be present in person or represented by proxy at such meeting in order to constitute a quorum for a transaction of any business.</p> <p>If at any meeting of Newmont Stockholders there is no quorum, the meeting may be adjourned by the chair of the Newmont Board or by a majority vote of the Newmont Stockholders present or represented, without any notice other than by announcement at the meeting, until a quorum is obtained.</p>
Shareholder meetings <i>Voting requirements</i>	<p>Unless the Corporations Act requires a special resolution, resolutions are passed by a simple majority of votes cast on the resolution. Under the Corporations Act, a special resolution may be passed by Newcrest Shareholders if not less than 28 days' notice of a general meeting is given, specifying the intention to propose the special resolution and stating the resolution. In order to pass, a special resolution requires approval of at least 75% of the votes cast by shareholders entitled to vote.</p> <p>The Corporations Act requires certain matters to be resolved by a company by special resolution, including:</p> <ul style="list-style-type: none"> – amendment to the company's constitution; – the change of name of the company; – a selective reduction of capital or selective share buy-back; – the conversion of ordinary shares into preference shares; and – a decision to wind up the company voluntarily. <p>The Newcrest constitution requires matters relating to the winding up of Newcrest be resolved by special resolution.</p> <p>Each Newcrest Share confers a right to vote at all general meetings. On a show of hands, each Newcrest Shareholder present in person, or by proxy, attorney or body corporate representative, has one vote. If a poll is held, Newcrest Shareholders present in person, or by their proxy, attorney or body corporate representative will have:</p> <ul style="list-style-type: none"> – one vote for each fully paid Newcrest Share held; and – a fraction of a vote for each partly paid Newcrest Share held (equivalent to the same proportionate value as the proportion of the amount paid up or agreed to be considered as paid up on the total issue price of that Newcrest Share at the time the poll is taken). 	<p>Newmont's certificate of incorporation provides that, other than any voting powers that may be granted to the holders of Newmont's preferred stock, if any, voting power is vested exclusively in Newmont Stockholders.</p> <p>Newmont's certificate of incorporation provides that at every meeting of Newmont Stockholders, Newmont Stockholders are entitled to one vote per Newmont Share and, except as otherwise provided in Newmont's certificate of incorporation or by-laws, the Newmont common stock and preferred stock, if any (and any other capital stock of Newmont at the time entitled thereto, if any), must vote together as a class.</p> <p>Newmont's by-laws provide that, subject to the rights of preferred stockholders, if any, to elect directors under specified circumstances, in an uncontested election, a nominee to the Newmont Board must be elected by (i) in the case of an uncontested election, a majority, and (ii) in the case of a contested election, a plurality of the votes cast at any meeting for the election directors at which a quorum is present. A "majority" means votes cast "for" a director's election must exceed 50% of the number of votes cast with respect to that director's election. "Votes cast" include directions to withhold authority and exclude abstentions. No Newmont Stockholder is allowed to exercise cumulative voting under Newmont's certificate of incorporation.</p> <p>All matters other than the election of directors will be determined by a majority vote of the Newmont Stockholders present in person or by proxy except as otherwise specifically provided by any applicable law or Newmont's certificate of incorporation or by-laws.</p> <p>In addition to any other consent of Newmont Stockholders required by law or the rules of the NYSE, Newmont's certificate of incorporation requires the affirmative vote or consent of the holders of 4/5 of all classes of stock of Newmont entitled to vote in elections of directors, considered for this purpose as one class (i) for the adoption of any agreement for the merger or consolidation of Newmont with or into any other corporation, or (ii) to authorise any sale or lease of all or any substantial part of the assets of Newmont to, or any sale or lease to Newmont or any subsidiary thereof in exchange for securities of Newmont or any assets (except assets having an aggregate fair market value of less than \$10,000,000), of any other corporation, person or other entity if, in the case of either (i) or (ii), as of the record date for the determination of stockholders entitled to notice thereof and to vote thereon or consent thereto, such other corporation, person or entity is the beneficial owner, directly or indirectly, of more than 10% of the outstanding shares of stock of Newmont entitled to vote in elections of directors for this purpose considered as one class.</p> <p>Under Newmont's by-laws, any action required to be taken at any annual or special meeting may be taken without a meeting if consents in writing have been signed by Newmont Stockholders having not less than the minimum number of votes that would be necessary to authorise or to take such action at a meeting at which all shares entitled to vote on such action were present and voted.</p>

10. Comparison of relevant Australian and United States laws

10.2 Comparison of laws *continued*

	Newcrest	Newmont
Shareholder meetings <i>Shareholders' rights to bring a resolution before a meeting</i>	<p>Under the Corporations Act, Newcrest Shareholders holding at least 5% of the votes that may be cast at a general meeting may by written notice to Newcrest propose a resolution for consideration at the next general meeting occurring more than two months after the date of the notice.</p>	<p>Under Newmont's by-laws, a stockholder of record, who is entitled to vote at the meeting and who complies with the notice procedures set forth in the by-laws and, in the case of director nominations, the requirements of Rule 14a-19 under the Exchange Act, must give timely written notice to Newmont's Secretary to bring before an annual meeting any nomination or other proper matter for stockholder action (other than stockholder proposals included in the proxy materials pursuant to the rules and regulations of the SEC, including Rule 14a-8 promulgated under the Exchange Act and qualifying director nominations pursuant to a proxy access notice by eligible stockholders pursuant to the provisions in Newmont's by-laws regarding proxy access).</p> <p>The stockholder's notice must be delivered to the Newmont Secretary at the principal executive offices of Newmont not later than the close of business on the 90th day nor earlier than the close of business on the 120th day prior to the first anniversary of the preceding year's annual meeting; provided, however, if the date of the annual meeting is more than 30 days before or more than 60 days after such anniversary date, notice by the stockholder to be timely must be so delivered not earlier than the close of business on the 120th day prior to such annual meeting and not later than the close of business on the later of the 90th day prior to such annual meeting or the 10th day following the day on which public announcement of the date of such meeting is first made by Newmont.</p> <p>Such notice must include the information required by Newmont's by-laws.</p> <p>In the event that the number of directors to be elected to the Newmont Board is increased by the Newmont Board and there is no public announcement by Newmont naming all of the nominees for director or specifying the size of the increased Newmont Board at least 70 days prior to the first anniversary of the preceding year's annual meeting, a stockholder's notice will be considered timely with respect to nominees for any new positions created by such increase if it is delivered to the Newmont Secretary by the close of business on the 10th day following the day of the public announcement first made by Newmont.</p> <p>Nominations of persons for election to the Newmont Board may be made at a special meeting of Newmont Stockholders at which directors are to be elected pursuant to Newmont's notice of meeting:</p> <ul style="list-style-type: none">– by or at the direction of the Newmont Board; or– provided that the Newmont Board has determined that directors will be elected at such meeting, by any Newmont Stockholder who (i) is a stockholder of record at the time the relevant notice is given, (ii) is entitled to vote at the meeting and (iii) complies with the notice procedures set forth in Newmont's by-laws and with the requirements of Rule 14a-19 under the Exchange Act. <p>In the event Newmont calls a special meeting of Newmont Stockholders for the purpose of electing one or more directors to the Newmont Board, any such Newmont Stockholder may nominate a person or persons (as the case may be) for election to such position(s) as specified in Newmont's notice of meeting, if the Newmont Stockholder's notice of such nomination is delivered to the Newmont Secretary not earlier than the close of business on the 120th day prior to such special meeting and not later than the close of business on the later of the 90th day prior to such special meeting or the 10th day following the day on which public announcement is first made of the date of the special meeting and of the nominees proposed by the Newmont Board to be elected at such meeting.</p> <p>In addition, Newmont's by-laws permit a Newmont Stockholder (or a group of no more than 20 Newmont Stockholders) who has maintained continuous qualifying ownership of at least 3% of the aggregate voting power of shares of Newmont eligible to vote for the election of directors for at least three years and has complied with the other requirements set forth in Newmont's by-laws, to submit director nominees for inclusion in Newmont's proxy statement if the stockholder(s) and the nominee(s) satisfy the requirements set forth in Newmont's by-laws. Notice of director nominees submitted under these by-law provisions must be delivered to the Newmont Secretary not less than 120 days or more than 150 days prior to the first anniversary of the date on which Newmont issued its definitive proxy statement for the preceding year's annual meeting. Such notice must include the information required by Newmont's by-laws. The maximum aggregate number of nominees nominated by Newmont Stockholders appearing in Newmont's proxy statement will not exceed the greater of two or 20% of the number of directors in office as of the last day on which a proxy access notice may be delivered in accordance with Newmont's by-laws.</p>



10.2 Comparison of laws *continued*

	Newcrest	Newmont
Directors <i>Directors' management of the business of the company</i>	Under the Newcrest constitution, the management and control of the business and affairs of Newcrest are vested in the Newcrest Board. The Newcrest Board may exercise all the powers of the company except any powers that the Corporations Act or the Newcrest constitution requires the company to exercise in a general meeting.	Under Newmont's certificate of incorporation: <ul style="list-style-type: none"> – the government of Newmont and its affairs must be conducted by the Newmont Board; and – the Newmont Board is empowered to exercise all such powers and do all such acts and things as may be exercised or done by Newmont, subject to the statutes of Delaware and Newmont's certificate of incorporation. <p>In addition, Newmont's by-laws provide that the Newmont Board will manage and control the business, property and affairs of Newmont and exercise all the powers of Newmont and do all such lawful acts and things as are not by statute or Newmont's certificate of incorporation or by-laws directed or required to be exercised or done by the Newmont Stockholders.</p>
Directors <i>Number and election of directors</i>	Under the Newcrest constitution, Newcrest must have no less than three and no more than 11 directors. The Newcrest Directors may, at any time, appoint any person as a Newcrest Director, either to fill a casual vacancy or as an addition to the Newcrest Board (provided that the total number of Newcrest Directors does not at any time exceed the maximum number of directors described above). A Newcrest Director may not hold office, without re-election: <ul style="list-style-type: none"> – for a period in excess of three years; or – past the third annual general meeting following the meeting at which the director was last elected or re-elected, whichever is the longer. Newcrest's managing director is exempt from the retirement and election by rotation procedures under the Newcrest constitution.	Newmont's certificate of incorporation provides that the number of directors will be fixed from time to time as provided in its by-laws. In case of any increase in the number of directors, the additional directors may be elected by the directors or by the Newmont Stockholders at an annual or special meeting, as provided in Newmont's by-laws. Newmont's by-laws provide that the number of directors must not be less than eight or more than seventeen. Within these specified limits, the number of directors will be determined from time to time by the affirmative vote of a majority of the directors then in office. Directors elected at any annual meeting of Newmont Stockholders or elected at any other time by Newmont Stockholders or by the Newmont Board, will hold office until the next annual meeting of Newmont Stockholders and until their respective successors are elected and qualified. Newmont's certificate of incorporation and by-laws provide that in the case of any vacancy in the Newmont Board through death, resignation or otherwise, the Newmont Board may, by affirmative vote of a majority of the directors then in office, elect a successor to hold office for the unexpired portion of the relevant director's term until the election of a successor.
Directors <i>Removal of directors</i>	The Newcrest Shareholders may remove a Newcrest Director before their period of office ends by passing a resolution to do so, at a general meeting. The resolution must be passed by a majority of the votes cast by Newcrest Shareholders present and voting. Under the Corporations Act, Newcrest Directors cannot themselves remove a Newcrest Director from office or require a Newcrest Director to vacate their office.	Under the DGCL, any or all members of the Newmont Board may be removed, with or without cause, by the holders of a majority of shares entitled to vote in the election of directors.

10. Comparison of relevant Australian and United States laws

10.2 Comparison of laws continued

	Newcrest	Newmont
Amendments to constituent documents	<p>Any amendment to the Newcrest constitution must be approved by a special resolution passed by Newcrest Shareholders present and voting on the resolution. A special resolution requires approval of at least 75% of the votes cast by Newcrest Shareholders entitled to vote.</p>	<p>Under the DGCL, unless Newmont's certificate of incorporation requires a greater vote or otherwise specified in the DGCL, an amendment to Newmont's certificate of incorporation requires:</p> <ul style="list-style-type: none">– the approval and recommendation of Newmont Board;– the affirmative vote of a majority of the outstanding stock entitled to vote on the amendment; and– the affirmative vote of a majority of the outstanding stock of each class entitled to vote on the amendment as a class. <p>Newmont's certificate of incorporation provides that it may be amended in the manner provided by the DGCL, except that any amendment to the provisions of Newmont's certificate of incorporation pertaining to certain business combinations and other transactions with interested stockholders requires the affirmative vote or consent of the holders of 4/5 of all classes of stock of Newmont entitled to vote in director elections.</p> <p>Newmont's certificate of incorporation and by-laws provide that, subject to any by-laws made by the Newmont Stockholders, the Newmont Board may make by-laws, and from time to time may alter, amend or repeal any by-law or by-laws; but any by-laws made by the Newmont Board may be altered or repealed by the Newmont Stockholders at any annual meeting, or at any special meeting, provided that notice of such proposed alteration or repeal be included in the notice of such special meeting.</p>
Issue of new shares	<p>Subject to specific exceptions, the ASX Listing Rules apply to restrict Newcrest from issuing, or agreeing to issue, more equity securities (including shares and options), than the number calculated as follows in any 12 month period without the approval of Newcrest Shareholders:</p> <ul style="list-style-type: none">– 15% of the total of:<ul style="list-style-type: none">> the number of Newcrest Shares on issue 12 months before the date of the issue or agreement to issue; plus> the number of Newcrest Shares issued in the 12 months under a specified exception; plus> the number of partly paid ordinary Newcrest shares that became fully paid in the 12 months; plus> the number of Newcrest Shares issued in the 12 months with Newcrest Shareholder approval; less> the number of Newcrest Shares cancelled in the 12 months; less– the number of equity securities issued or agreed to be issued in the 12 months but not under a specified exception or with Newcrest Shareholder approval. <p>Subject to certain exceptions, the ASX Listing Rules require the approval of Newcrest Shareholders by ordinary resolution in order for Newcrest to issue shares or options to Newcrest Directors.</p> <p>Under the Newcrest constitution, the Newcrest Directors may issue shares, subject to the Corporations Act, the ASX Listing Rules, and any special rights conferred on the holders of any shares or class of shares.</p>	<p>Newmont is currently authorised under its certificate of incorporation to issue 1,285,000,000 shares of all classes of stock, of which 5,000,000 shares may be preferred stock and 1,280,000,000 shares may be common stock.</p> <p>The Newmont Board may by resolution create and provide for the issuance of series of preferred stock and, in connection with the creation of each such series, fix the designations and the powers, preferences and rights, and the qualifications, limitations or restrictions of such series which are not fixed in the certificate of incorporation.</p> <p>Except as may be provided in the provisions fixed by the Newmont Board for any series of preferred stock, the number of authorised shares of any class of stock of Newmont may be increased or decreased by the affirmative vote of the holders of a majority of the outstanding shares of stock of Newmont entitled to vote.</p> <p>Under NYSE Listing Rules, stockholder approval is required for certain significant issuances of securities, including issuances (in each case subject to certain exceptions):</p> <ul style="list-style-type: none">– in connection with new or materially amended equity compensation plans;– to a related party (including directors, officers, substantial security holders and their affiliates); or– in any transaction if the number of shares or voting power of common stock is, or will be upon issuance, equal to or in excess of 20% of the number of shares or voting power of common stock outstanding before the issuance of such common stock (or of securities convertible into or exercisable for common stock). <p>At the Newmont Stockholder Meeting, Newmont Stockholders will be asked to approve an amendment and restatement of the Newmont's certificate of incorporation to increase Newmont's authorised shares of common stock from 1,280,000,000 shares to 2,550,000,000 shares (the Amendment Proposal). The Scheme is not conditional on the Amendment Proposal being approved.</p>



10.2 Comparison of laws *continued*

	Newcrest	Newmont
Share buy-backs and redemptions	<p>Under the Corporations Act, different procedures apply to buy-backs of Newcrest Shares depending on the type of buy-back. Generally, Newcrest may buy-back its own shares if the buy-back does not materially prejudice its ability to pay creditors.</p> <p>Generally, if all shareholders are given an equal opportunity to have their shares bought back and the buy-back would result in Newcrest, during the 12 month period prior to and including the buy-back, acquiring 10% or more of the smallest number of votes attaching to voting shares on issue in Newcrest, then an ordinary resolution of Newcrest Shareholders would be required.</p> <p>A selective buy-back, where not all shareholders are given an equal opportunity to access the buy-back, would require a special resolution of Newcrest Shareholders whose shares are not being bought back.</p> <p>Newcrest Shares that have been bought back must be cancelled.</p>	<p>Under the DGCL, Newmont is permitted to buy-back its shares, provided that it does not impair Newmont's capital and subject to certain other limitations.</p>
Variation of class rights	<p>Under the Corporations Act, rights attaching to any class of share in Newcrest may only be varied:</p> <ul style="list-style-type: none"> – by a special resolution passed at the meeting of the shareholders entitled to vote and holding shares in that class; or – with the written consent of shareholders with at least 75% of the votes in the class. 	<p>Under the DGCL, the holders of the outstanding shares of a class of stock of Newmont are entitled to vote as a class upon any proposed amendment to Newmont's certificate of incorporation that will:</p> <ul style="list-style-type: none"> – increase or decrease the number of authorised shares of the class; – increase or decrease the par value of the shares of the class; or – alter or change the powers, preferences or special rights of the shares of the class so as to affect them adversely. <p>Such a proposed amendment requires the approval of a majority of the outstanding shares of each class entitled to vote thereon.</p> <p>Newmont's certificate of incorporation provides that, except as may be provided in the provisions fixed by the Newmont Board for any series of preferred stock, if any, the number of authorised shares of any class of stock of Newmont may be increased or decreased by the affirmative vote of the holders of a majority of the outstanding shares of stock of Newmont entitled to vote.</p>

10. Comparison of relevant Australian and United States laws

10.2 Comparison of laws *continued*

	Newcrest	Newmont
Protection of minority shareholders and the oppression remedy	<p>Under the Corporations Act, any Newcrest Shareholder can bring an action in cases of conduct which is contrary to the interests of Newcrest Shareholders as a whole, or oppressive to, unfairly prejudicial to, or unfairly discriminatory against, any Newcrest Shareholder(s), whether in their capacity as a shareholder or in any other capacity. Former Newcrest Shareholders can also bring an action if it relates to the circumstances in which they ceased to be a Newcrest Shareholder.</p> <p>A statutory derivative action may also be instituted by a shareholder, former shareholder or person entitled to be registered as a shareholder, of Newcrest. In all cases, leave of the court is required. Such leave will be granted if the court is satisfied that:</p> <ul style="list-style-type: none">– it is probable that Newcrest will not itself bring the proceedings or properly take responsibility for them or for the steps in them;– the applicant is acting in good faith;– it is in the best interests of Newcrest that the applicant be granted leave;– if the applicant is applying for leave to bring proceedings, there is a serious question to be tried; and– either, at least 14 days before making the application, the applicant gave written notice to Newcrest of the intention to apply for leave or the reasons for applying, or it is otherwise appropriate to grant leave.	<p>Under Delaware law, under certain circumstances, a Newmont Stockholder may bring a derivative action on behalf of Newmont to enforce a right that Newmont may properly assert and that Newmont has failed to properly assert.</p> <p>Under the DGCL, a Newmont Stockholder who wishes to bring a derivative action must meet certain requirements, including that such stockholder was a Newmont Stockholder at the time of the transaction of which such stockholder complains or that such stockholder's shares thereafter devolved upon such stockholder by operation of law. In addition, a Newmont Stockholder who wishes to bring a derivative action must make a demand on the Newmont Board to assert the corporate claim, unless that demand would be futile.</p> <p>The DGCL does not provide for a statutory remedy for a breach of fiduciary duties that is comparable to the oppression remedy under the Corporations Act, however, stockholders may be entitled to remedies for violation of a director's fiduciary duties under Delaware common law. Specifically, Delaware case law has developed such that a controlling stockholder of Newmont, if any, when acting in its capacity as a controlling stockholder, may owe fiduciary duties to minority stockholders in certain circumstances, and minority stockholders may bring claims for breach of such duties. These duties may include the duties of loyalty and care. They also may include a duty of disclosure which requires that, when seeking stockholder approval of an action in which a controlling stockholder has a material interest, the minority stockholders be informed of all facts relevant to the decision. There is no reason to expect that under Delaware law there is any fiduciary duty owed by a controlling stockholder to minority stockholders when the controlling stockholder acts pursuant to the terms of an existing contractual arrangement.</p>
Source and payment of dividends	<p>Under the Corporations Act, Newcrest must not pay a dividend unless:</p> <ul style="list-style-type: none">– Newcrest's assets exceed its liabilities immediately before the dividend is declared and the excess is sufficient for the payment of the dividend;– the payment of the dividend is fair and reasonable to Newcrest Shareholders as a whole; and– the payment of the dividend does not materially prejudice Newcrest's ability to pay creditors. <p>Subject to the Corporations Act, the Newcrest constitution and the terms of issue or rights of any shares with special rights to dividends, the Newcrest Directors may declare or determine that a dividend is payable, fix the amount and time for payment and authorise the method of payment of a dividend.</p>	<p>Newmont Stockholders are entitled to ratably receive dividends if, as, and when declared from time to time by the Newmont Board, after payment of any dividends that may be required to be paid on preferred stock, if any.</p> <p>Under the DGCL, Newmont may only pay dividends out of either surplus (as determined under the DGCL) or its net profits for the current or the immediately preceding fiscal year.</p>



10.2 Comparison of laws *continued*

	Newcrest	Newmont
Remuneration of directors and officers	<p>Under the ASX Listing Rules, the maximum amount to be paid to Newcrest Directors for their services as directors (other than the salary of an executive director) is not to exceed the amount approved by Newcrest Shareholders. As at the date of this Scheme Booklet, the latest approval was at Newcrest's 2010 annual general meeting, at which Newcrest Shareholders had approved aggregate remuneration for all non-executive directors of A\$2,700,000 per annum.</p> <p>Newcrest's annual report includes a remuneration report within the director's report. This remuneration report is required to include a discussion of the Newcrest Board's policy in relation to remuneration of key management personnel of Newcrest.</p> <p>Under the Corporations Act, a listed company such as Newcrest must put its remuneration report to a shareholder vote at its annual general meeting. If in two consecutive annual general meetings, 25% or more of the votes cast on the resolution vote against adopting the remuneration report, a 'spill resolution' must then be put to shareholders. A spill resolution is a resolution that a spill meeting be held and all directors (other than a managing director who is exempt for the requirement by rotation requirements) cease to hold office immediately before the end of the spill meeting. If the spill resolution is approved by the majority of votes cast on the resolution, a spill meeting must be held within 90 days at which directors wishing to remain must stand for re-election.</p>	<p>Under the DGCL, unless otherwise restricted by Newmont's certificate of incorporation or by-laws, the Newmont Board has the authority to fix the compensation of directors.</p> <p>Under United States securities laws, Newmont is required to disclose certain information about its policies and practices related to compensation for directors and executive officers.</p> <p>United States' publicly traded companies are also required to hold advisory (i.e. non-binding) shareholder votes on:</p> <ul style="list-style-type: none"> – executive compensation ("say-on-pay votes") at least once every three years; and – the frequency of such say-on-pay votes at least once every six years, in order to allow shareholders to express their views on a company's compensation decisions. <p>Newmont currently holds the say-on-pay vote every year.</p>
Retirement benefits	<p>The Corporations Act provides that, in respect of termination benefits payable to a company director, senior executive or key management personnel under employment contracts entered into, renewed or varied on or after 24 November 2009, shareholder approval is required if the total value of the benefits exceed one year of that person's base salary.</p>	<p>There is no limit on, or requirement of stockholder approval for, the payment of any termination or retirement benefits to directors and officers in the DGCL, Newmont's certificate of incorporation or by-laws or the rules of the NYSE.</p> <p>Under United States securities laws, Newmont is required to disclose certain information about its retirement and other post-employment compensation for directors and executive officers.</p>

10. Comparison of relevant Australian and United States laws

10.2 Comparison of laws continued

	Newcrest	Newmont
Fiduciary duties of directors and officers	<p>Under Australian law, the directors and officers of a company such as Newcrest are subject to a range of duties including duties to:</p> <ul style="list-style-type: none">– act in good faith in the best interests of the company;– act for a proper purpose;– not fetter their discretion (in the case of directors only);– exercise care and diligence in the performance of their duties;– avoid conflicts of interest;– not use their position to gain advantage for themselves or someone else, or to cause detriment to the company;– not misuse information which they have gained through their position to gain advantage for themselves or someone else, or to cause detriment to the company; and– otherwise act in accordance with the Corporations Act and, subject to the provisions of the Corporations Act, Newcrest’s constitution.	<p>Under Delaware law, Newmont Directors owe fiduciary duties, including the duty of care and the duty of loyalty, to Newmont and the Newmont Stockholders. The duty of care generally requires Newmont Directors to inform themselves of all reasonably available information before making business decisions on behalf of Newmont and to act with requisite care in discharging their duties to Newmont. The duty of loyalty generally requires Newmont Directors to act in good faith and in Newmont’s best interests instead of their personal interests, and avoid conflicts of interest and self-dealing.</p>
Release from liability and indemnification of directors and officers	<p>Under Australian law, Newcrest cannot:</p> <ul style="list-style-type: none">– exempt an officer or auditor from liability to Newcrest incurred in their capacity as an officer or auditor;– indemnify an officer or auditor against a liability owed to Newcrest or a related body corporate; and– indemnify an officer or auditor against the legal costs incurred in defending certain legal proceedings, including proceedings in which the person is found liable to Newcrest or a related body corporate. <p>The Newcrest constitution contains a provision requiring Newcrest to indemnify each officer of Newcrest (to the extent not precluded by law from doing so and to the extent they are not otherwise indemnified) out of the assets of Newcrest against any liability incurred by the officer in, or arising out of, the conduct of the business of Newcrest or the discharge of duties of the officer.</p>	<p>Newmont’s certificate of incorporation provides that to the fullest extent permitted by applicable law (a) the Newmont Directors will under no circumstances have any personal liability to Newmont or Newmont Stockholders for monetary damages for breach of fiduciary duty as a Newmont Director except for breaches and acts or omissions with respect to which the DGCL expressly provides that Newmont may not eliminate or limit such personal liability and (b) Newmont will indemnify each of its directors and officers to the fullest extent permitted by applicable law, notwithstanding possible self-interest of the Newmont Directors in the action being taken. Under the DGCL, Newmont may not eliminate or limit personal liability to Newmont or Newmont Stockholders for monetary damages with respect to:</p> <ul style="list-style-type: none">– directors or officers for breach of the duty of loyalty;– directors or officers for acts or omissions not in good faith or involving intentional misconduct or a knowing violation of law;– directors for unlawful payments of dividends, or unlawful share repurchases or redemptions;– directors or officers for any transaction from which the relevant Newmont director or officer derived an improper personal benefit; or– an officer in any action by or in the right of Newmont. <p>In addition, Newmont’s by-laws provide that Newmont will indemnify to the fullest extent permitted by applicable law, any person made, or threatened to be made a party, to any action, suit or proceeding by reason of the fact that such person was a director or officer of Newmont, or serving as a director, officer or trustee of another entity at Newmont’s request, against expenses (including attorneys’ fees), judgments, fines and amounts paid in settlement actually and reasonably incurred by such person in connection therewith.</p> <p>Newmont’s by-laws further provide that, to the fullest extent permitted by applicable law, Newmont from time to time will reimburse or advance to any such person the funds necessary for payment of expenses, including attorneys’ fees, incurred in connection with any such action, suit or proceeding, upon receipt of a written undertaking by such person to repay such amount(s) if it is ultimately determined that such person is not entitled to be indemnified by Newmont.</p>

10.2 Comparison of laws *continued*

	Newcrest	Newmont
<p>Transactions involving directors, officers or other related parties</p>	<p>The Corporations Act prohibits a public company such as Newcrest from giving a related party a financial benefit unless it:</p> <ul style="list-style-type: none"> – obtains the approval of shareholders and gives the benefit within 15 months after receipt of such approval; or – the financial benefit is exempt. <p>A related party is defined by the Corporations Act to include any entity which controls the public company, directors of the public company, directors of any entity which controls the public company and, in each case, spouses and certain relatives of such persons.</p> <p>Exempt financial benefits include indemnities, insurance premiums and payments for legal costs which are not otherwise prohibited by the Corporations Act and benefits given on arm's length terms.</p> <p>The ASX Listing Rules prohibit a listed entity such as Newcrest from acquiring a substantial asset (an asset the value or consideration for which is 5% or more of the entity's equity interests) from, or disposing of a substantial asset to, certain related parties of the entity, unless it obtains the approval of shareholders. The related parties include directors, persons who have or have had (in aggregate with any of their Associates) in the prior six month period an interest in 10% or more of the shares in the company and, in each case, any of their Associates. The provisions apply even where the transaction may be on arm's length terms.</p> <p>The ASX Listing Rules also prohibit a listed entity such as Newcrest from issuing or agreeing to issue shares to a director unless it obtains the approval of shareholders or the share issue is exempt. Exempt share issues include issues made pro rata to all shareholders, under an underwriting agreement in relation to a pro rate issue, under certain dividend or distribution plans or under an approved employee incentive plan.</p> <p>The Corporations Act generally requires a Newcrest Director who has a material personal interest in a matter that relates to the affairs of Newcrest to give the other Newcrest Directors notice of that interest. That Newcrest Director must not be present at a meeting where the matter is being considered or vote on the matter unless the other Newcrest Directors or ASIC approve, or the matter is not one which requires disclosure under the Corporations Act. Under the Corporations Act, failure of a Newcrest Director to disclose a material personal interest, or voting despite a material personal interest, does not affect the validity of a contract in which the Newcrest Director has an interest. Newcrest Directors, when entered into transactions with Newcrest, are subject to the common law and statutory duties to avoid conflicts of interest.</p>	<p>Under the DGCL, a contract or transaction between Newmont and one or more of its directors or officers will not be void or voidable solely for this reason, or solely because a director or officer is present at or participates in the meeting of the Newmont Board or a committee of the Newmont Board which authorises the contract or transaction, or solely because any such director's or officer's votes are counted for such purpose, if:</p> <ul style="list-style-type: none"> – material facts as to the director's or officer's relationship or interest and as to the contract or transaction are disclosed or are known to the Newmont Board or such committee, and the Newmont Board or such committee in good faith authorises the contract or transaction by a majority of the disinterested directors, even though the disinterested directors be less than a quorum; – material facts as to the director's or officer's relationship or interest and as to the contract or transaction are disclosed or are known to Newmont Stockholders entitled to vote thereon, and the contract or transaction is specifically approved in good faith by vote of Newmont Stockholders; or – the contract or transaction is fair as to Newmont as of the time it is authorised, approved or ratified by the Newmont Board, a committee of the Newmont Board or the Newmont Stockholders. <p>In addition, under the DGCL, interested directors may be counted in determining the presence of a quorum at a meeting of the Newmont Board or a committee of the Newmont Board which authorises the contract or transaction.</p> <p>Under United States securities laws, Newmont is required to disclose certain information about certain recent or proposed transactions in which:</p> <ul style="list-style-type: none"> – the amount involved exceeds \$120,000; and – any related person (including any director, officer or beneficial owner of more than 5% of any class of voting securities of Newmont) had or will have a direct or indirect material interest, including the name of the related person, the related person's interest in the transaction, the approximate dollar value of such interest and other material information. <p>Newmont is also required to disclose its policies and procedures for the review and approval of such transactions.</p>

10. Comparison of relevant Australian and United States laws

10.2 Comparison of laws *continued*

	Newcrest	Newmont
Disclosure obligations	<p>Newcrest is a 'disclosing entity' for the purposes of the Corporations Act and subject to the periodic and continuous disclosure requirements of the Corporations Act and the ASX Listing Rules. Broadly, these obligations include the requirement, subject to exceptions for certain confidential information, to notify ASX immediately of any information of which it becomes aware that a reasonable person would expect to have a material effect on the price or value of Newcrest Shares.</p> <p>Newcrest is also required to make announcements to the ASX on specified issues. Some of these announcements are required on a regular basis, including notifying ASX of proxy voting results at the annual general meeting, providing dividend details and providing copies of notices of meeting. Other one-off announcements are required depending upon a company's individual circumstances at a particular time. These obligations apply in addition to Newcrest's continuous disclosure obligations.</p> <p>Newcrest is also required to prepare and lodge with ASIC and ASX both yearly and half-yearly financial statements accompanied by a director's declaration and report, and a yearly audit report and half-yearly review report.</p> <p>The ASX Listing Rules also impose additional reporting obligations on Newcrest as a mining entity. Newcrest must complete a report for each quarter, which must be released no later than one month after the end of the quarter. As a mining company listed on the ASX, Newcrest must prepare its public reports in accordance with the ASX Listing Rules and the JORC Code. As a mining company listed on the TSX, Newcrest must also comply with National Instrument 43-101 when disclosing scientific and technical information.</p> <p>All announcements provided to ASX must also be provided to PNGX, and Newcrest is required by PNGX to comply with all of the ASX Listing Rules.</p>	<p>As outlined in section 7.8(e), Newmont will apply for admission to the official list of ASX as a Foreign Exempt Listing, conditional on the Scheme being implemented. Once listed on ASX as a Foreign Exempt Listing, Newmont (as the parent company of the Merged Group) will be exempt from complying with most of the ASX Listing Rules, including the Australian continuous disclosure regime set out in ASX Listing Rule 3.1. However, Newmont must provide to ASX a copy of each public filing it makes with the SEC.</p> <p>Under United States securities laws, Newmont is required to file with the SEC certain documents periodically or upon the occurrence of certain events, including:</p> <ul style="list-style-type: none">– annual reports on Form 10-K within 60 days after the fiscal year end, containing, among other things, a description of the business, Newmont's audited financial statements, management's discussion and analysis of financial condition and results of operation, material pending legal proceedings, and disclosures about certain material risks;– quarterly reports on Form 10-Q within 40 days after the end of each of the first three fiscal quarters, containing, among other things, Newmont's unaudited financial statements, management's discussion and analysis of financial condition and results of operation, commencement or termination of material legal proceedings or material developments to previously disclosed material legal proceedings, and disclosures regarding certain material changes from previously disclosed risks; and– current reports on Form 8-K, upon the occurrence of certain specified significant events (generally within four business days of a specified event), which include, but are not limited to, entry into, material amendment to, or termination of, a material definitive agreement, bankruptcy proceedings, receipt of certain notices and orders under US mine safety laws, completion of an acquisition or disposition of a significant amount of assets, releases disclosing material non-public information regarding results of operations or financial condition, receipt of notice of delisting or failure to satisfy a continued listing rule or standard, changes in certifying accountants and non-reliance on previously issued financial statements, material modifications to rights of security holders, election of directors, appointment of principal officers, departures of directors or principal officers, amendments to articles of incorporation or bylaws, the results of stockholder votes, and any known changes in control. <p>Under Section 204.00 of the NYSE Listed Company Manual, Newmont must give prompt notice to the NYSE regarding certain significant actions and events, including corporate name changes, changes in the character or nature of Newmont's business, change of auditors, fixing of stockholders' record dates or closing of transfer books for any purpose, any dividend actions or actions relating to a stock distributions, material dispositions of assets, and changes of directors or officers.</p> <p>Newmont is required to present its financial statements in accordance with US GAAP. US public companies are permitted to provide non-US GAAP financial measures so long as such measures are not misleading and are in compliance with applicable SEC rules and regulations, which include, but are not limited to, the requirement that a company must present the most directly comparable US GAAP financial measure and provide a reconciliation of the non-US GAAP financial measure to the most directly comparable US GAAP financial measure.</p> <p>An Independent Registered Public Accounting Firm is required to conduct its audits of Newmont's annual financial statements in accordance with the standards of the US Public Company Accounting Oversight Board (PCAOB). The PCAOB standards require that auditors plan and perform their audits to obtain reasonable assurance about whether financial statements are free of material misstatement, whether due to error or fraud. The financial statements are the responsibility of Newmont's management. The auditor is responsible for expressing an opinion on Newmont's financial statements based on its audits. The objective of audits of financial statements by independent auditors under PCAOB standards is to express an opinion on the fairness with which the financial statements present, in all material respects, financial position, results of operations, and its cash flows in conformity with US GAAP.</p>

10.2 Comparison of laws *continued*

	Newcrest	Newmont
Disclosure of substantial shareholders	<p>A person who obtains voting power in 5% or more of an ASX listed company is required to publicly disclose that fact within two business days via the filing of a substantial holding notice. A person's voting power consists of their own Relevant Interest in shares plus the Relevant Interests of their Associates. A further notice needs to be filed within two business days after each subsequent voting power change of 1% or more, and after the person ceases to have voting power of 5% or more. The notice must attach all documents which contributed to the voting power the person obtained, or provide a written description of arrangements which are not in writing.</p>	<p>A person who acquires, or a group of persons who acquire, directly or indirectly beneficial ownership of more than 5% of a voting class of a company's equity securities registered under section 12 of the Exchange Act is required to file a Schedule 13D with the SEC within 10 days after the acquisition. However, depending upon the facts and circumstances, including whether the person or group has acquired the security with no intent of influencing control of the issuer, the person or group of persons may be eligible to file the more abbreviated Schedule 13G in lieu of Schedule 13D. Any material changes in the facts contained in a Schedule 13D or Schedule 13G (including a material increase or decrease in the percentage of the class of equity securities that are beneficially owned by the person or group making the filing) require prompt amendment of the relevant schedule.</p>
Takeovers <i>Takeover requirements</i>	<p>Australian law restricts a person from acquiring control of voting shares in Newcrest where, as a result of the acquisition, that person's or someone else's voting power in the company increases from 20% or below to more than 20%, or from a starting point that is above 20% and below 90%. Exceptions to this restriction include:</p> <ul style="list-style-type: none"> – an acquisition of no more than 3% of the voting shares in the company within a six month period; – an acquisition approved by an ordinary resolution (requiring more than 50% of votes cast) of shareholders, but with no votes cast in favour by the person proposing to make the acquisition or their Associates; – an acquisition made under a takeover bid conducted in accordance with Australian law; or – an acquisition that results from a court-approved compromise or arrangement that requires approval by a majority in number and at least 75% of the votes cast by shareholders in each class on which the arrangement will be binding. <p>Takeover bids must treat all shareholders alike and must not involve any collateral benefits. Various restrictions about conditional offers exist and there are also restrictions concerning the withdrawal and suspension of offers.</p> <p>Newcrest Shareholders may be required to sell their Newcrest Shares:</p> <ul style="list-style-type: none"> – under compulsory acquisition requirements, such as where a bidder has made a takeover offer for all shares in a class and the bidder acquires a Relevant Interest in at least 90% (by number) of shares in the class (having acquired at least 75% of the shares the bidder offered to acquire); or – pursuant to a court-approved compromise or arrangement. 	<p>Under the DGCL if a person acquires 15% or more of Newmont's voting shares (such person, an interested stockholder), then Newmont may not engage in certain business combinations with such interested stockholder for the three years following the time the stockholder became an interested stockholder unless:</p> <ul style="list-style-type: none"> – the Newmont Board had approved either the business combination or the transaction that resulted in the person becoming an interested stockholder; – upon consummation of the transaction that resulted in the stockholder becoming an interested stockholder, the interested stockholder owned at least 85% of Newmont's voting shares (with certain exceptions); or – the business combination is approved by the Newmont Board and by 2/3 of the outstanding voting shares not owned by the interested stockholder. <p>Certain provisions of Newmont's certificate of incorporation and by-laws may have the effect of restricting takeovers, such as provisions:</p> <ul style="list-style-type: none"> – authorising the Newmont Board to issue any series of preferred stock and to fix the designations, powers, preferences and rights thereof; and – requiring advance notice of a Newmont Stockholder's intention to nominate directors or submit proposals at a Newmont Stockholders' meeting.

10. Comparison of relevant Australian and United States laws

10.2 Comparison of laws *continued*

	Newcrest	Newmont
Takeovers <i>Takeover protections</i>	<p>Under Australian takeovers legislation and policy, boards of Australian companies are limited in the additional non-statutory defensive mechanisms that they can put in place to discourage or defeat a takeover bid. Therefore, it is likely that the adoption of certain antitakeover mechanisms by the board, without shareholder approval, such as a shareholders' rights plan (or so-called 'poison pill'), would give rise to a declaration of unacceptable circumstances by the Australian Takeovers Panel if it discouraged or defeated a takeover bid.</p>	<p>Under Delaware law, there are a number of defensive mechanisms available to protect the corporation and its stockholders against hostile takeover bids. In particular, shareholder rights plans, which have been generally upheld by the Delaware courts, can protect a corporation and its stockholders from non-negotiated hostile takeover attempts made at unfair or inadequate prices or by coercive or unfair tactics.</p>
Restrictions on transactions with significant shareholders	<p>The ASX Listing Rules contain restrictions on listed companies, such as Newcrest, acquiring or disposing of substantial assets from or to a substantial shareholder who, along with their associates, holds at least 10% of the company's voting securities (or has in the last six months), without disinterested shareholder approval. Substantial assets are assets that represent at least 5% of the company's equity interests (essentially 5% of its net asset value), as set out in the latest financial statements. Shareholder approval for such transactions requires a simple majority of votes cast by the company's ordinary shareholders, with parties to the transaction (and their associates) not voting.</p> <p>Refer to 'Transactions involving directors, officers or other related parties' which sets out the restriction on listed companies from acquiring or disposing of substantial assets from or to a substantial shareholder.</p>	<p>See 'Shareholder meetings – Voting requirements' above.</p>
Right to inspect register of shareholders	<p>Under Australian law, the register of shareholders of a company is usually kept at the registered office or principal place of business in Australia and must be available for inspection to shareholders free of charge at all times when the registered office is open to the public.</p> <p>If a person asks Newcrest for a copy of the Newcrest Share Register (or any part of the Newcrest Share Register) and pays the requested fee (up to a prescribed amount), Newcrest must give that person the copy within seven days of the date on which Newcrest receives such payment.</p>	<p>Under the DGCL, for at least 10 days before any meeting of the Newmont Stockholders, a complete list of the Newmont Stockholders entitled to vote at such meeting must be made and be open to examination by any Newmont Stockholder for any purpose germane to such meeting for a period of 10 days ending on the day before the meeting date.</p> <p>Newmont's by-laws provide that the complete list of the Newmont Stockholders entitled to vote at the meeting must be made and be open to the examination of any Newmont Stockholder for at least 10 days prior to the meeting at Newmont's principal place of business, and must be produced at the meeting and be subject at all times during the meeting to the inspection of any Newmont Stockholder present.</p>

10.2 Comparison of laws *continued*

	Newcrest	Newmont
Right to inspect corporate books and records	<p>Under the Corporations Act, a shareholder must obtain a court order to obtain access to the corporate books. The applicant must be acting in good faith and be making the inspection for a proper purpose.</p>	<p>Newmont's certificate of incorporation and by-laws are on file with the SEC.</p> <p>Under the DGCL, upon written demand under oath stating the purpose thereof, each Newmont Stockholder has the right during usual business hours to inspect for any proper purpose Newmont's stock ledger, stockholder list and certain books and records, and to make copies and extracts from those documents. If Newmont refuses to permit such inspection or does not reply to the stockholder's written demand within five business days, the relevant Newmont Stockholder may apply to the Delaware Court of Chancery for an order to compel inspection.</p> <p>Newmont's by-laws provide that the Newmont Board may determine whether and to what extent, and at what times and places and under what conditions and regulations, the books, accounts and records of Newmont (other than the stock ledger) must be open to the inspection of any Newmont Stockholder. No Newmont Stockholder has the right to inspect any books, accounts, records or documents of Newmont unless expressly so authorised by Delaware law, Newmont's by-laws or a resolution of the Newmont Board.</p>
Winding up	<p>Under Australian law, an insolvent company may be wound up by a liquidator appointed either by creditors or by the court. Directors cannot use their powers after a liquidator has been appointed. If there are funds left over after payment of the costs of the liquidation, and payments to other priority creditors, including employees, the liquidator will pay these to unsecured creditors as a dividend. These shareholders rank behind the creditors and are, therefore, unlikely to receive any dividend in an insolvent liquidation.</p> <p>Under Australian law, shareholders of a solvent company may decide to wind up the company if the directors are able to form the view that the company will be able to pay its debts in full within 12 months after the commencement of the winding up. A meeting at which a decision is made to wind up a solvent company requires at least 75% of votes cast by the shareholders present and voting.</p> <p>The Newcrest constitution provides that on winding up, the liquidator may divide among all or any of the contributories as the liquidator thinks fit in specie or kind any part of Newcrest's assets. Any division may be otherwise than in accordance with the legal rights of the contributories, but if any such division is determined, any contributory who would be prejudiced has a right to dissent and ancillary rights as if the determination was a special resolution under the Corporations Act relating to the sale or transfer of the company's assets by a liquidator in a voluntary winding up.</p>	<p>Under the DGCL, Newmont may be dissolved if:</p> <ul style="list-style-type: none"> – a majority of the Newmont Board adopts a resolution to approve dissolution at a board meeting called for that purpose and thereafter notice of a stockholder meeting to take action on the matter is given to each Newmont Stockholder entitled to vote thereon; – a majority of outstanding shares entitled to vote on the matter votes for the proposed dissolution at the stockholders' meeting called for that purpose; and – a certification of dissolution is thereafter filed with the Delaware Secretary of State. <p>The DGCL also permits the Newmont Stockholders to authorise the dissolution of Newmont without board action if all the Newmont Stockholders entitled to vote on the matter provide written consent to dissolution and a certificate of dissolution is filed with the Delaware Secretary of State.</p>

11. Additional information

11.1 Interests of Newcrest Directors in Newcrest Shares

As at the Last Practicable Date, the Newcrest Directors have the following Relevant Interests in Newcrest Shares:

Newcrest Director	Number of Newcrest Shares
Peter Tomsett	43,799
Philip Aiken AM	19,940
Philip Bainbridge	9,910
Roger Higgins	13,675
Sally-Anne Layman	10,510
Jane McAloon AM	6,132
Vickki McFadden	12,208

No Newcrest Director acquired or disposed of a Relevant Interest in any Newcrest Shares during the four months before the date of this Scheme Booklet.

11.2 Newcrest Equity Incentives

As set out in Note 35 of Newcrest's consolidated financial statements for the year ended 30 June 2023, Newcrest provides benefits to employees in the form of share-based compensation, whereby employees render services in exchange for shares or rights over shares. This includes a Long-Term Incentive Plan, an Employee Share Acquisition Plan, a Share Match Plan, a Sign-On Share Plan and a Short Term Incentive Plan (as described in Newcrest's consolidated financial statements).

Under the Scheme Implementation Deed, as a Condition Precedent of the Scheme, Newcrest is required to do all things and take all necessary steps by 8.00am on the Second Court Date to ensure that all Newcrest Equity Incentives vest or lapse before the Scheme Record Date (so that, on implementation of the Scheme, Newmont will hold all of the issued shares in Newcrest and no other rights over shares will exist). This includes all shares or rights issued under the Plans mentioned above.

Accordingly, with Newmont's agreement, the Newcrest Board has exercised its discretions under the Plans to ensure that all Newcrest Equity Incentives vest or lapse before the Scheme Record Date, conditional on the Scheme becoming Effective. This includes allowing unvested rights to vest and freeing restricted shares of dealing restrictions. Further detail regarding the treatment of Newcrest Equity Incentives is set out in Newcrest's remuneration report (which is included in Newcrest's annual financial report) for the year ended 30 June 2023.

No Newcrest Director is entitled to any shares or rights under the relevant Plans.

11.3 Other benefits and agreements

a) Interests of Newcrest Directors in Newmont securities

No Newcrest Director has a Relevant Interest in any securities in Newmont.

No Newcrest Director has acquired or disposed of a Relevant Interest in any securities in Newmont during the four months before the date of this Scheme Booklet.

b) Interests of Newcrest Directors in contracts with Newmont

No Newcrest Director has any interest in any contract entered into by Newmont, or any of its related bodies corporate.

c) Benefits in connection with retirement from office

There is no payment or other benefit that is proposed to be made or given to any director, secretary or executive officer of Newcrest (or any of its Related Bodies Corporate) as compensation for the loss of, or consideration for or in connection with his or her retirement from, office in Newcrest (or any of its Related Bodies Corporate) in connection with the Scheme.

d) Benefits from Newmont

No Newcrest Director has agreed to receive, or is entitled to receive, any benefit from Newmont, or any of its Related Bodies Corporate, which is conditional on, or is related to, the Scheme.

e) Agreements connected with or conditional on the Scheme

Other than as disclosed in section 11.2, there are no agreements or arrangements made between any Newcrest Director and any other person in connection with, or conditional on, the outcome of the Scheme.

11.4 Scheme Implementation Deed

a) Introduction

On 15 May 2023, Newcrest, Newmont, Newmont Overseas entered into the Scheme Implementation Deed, under which the parties agreed to implement the Scheme.

A summary of the key terms of the Scheme Implementation Deed is set out in this section 11.4. A full copy of the Scheme Implementation Deed was released to the ASX (www.asx.com.au), PNGX (www.pngx.com.pg) and on TSX (via SEDAR) (www.sedar.com).

b) Conditions to the Scheme (clause 3.1)

The Scheme is subject to a number of Conditions Precedents set out in clause 3.1 of the Scheme Implementation Deed.

The Scheme will not proceed unless all of the Conditions Precedent to the Scheme are satisfied or waived (where capable of waiver) in accordance with the Scheme Implementation Deed.

The Conditions Precedents are listed below.

- **FIRB approval:** notice is received by or on behalf of the Treasurer of the Commonwealth of Australia advising Newmont that the Commonwealth of Australia has no objections to Newmont Overseas acquiring Newcrest;
- **HSR Act:** the waiting period applicable to the Transaction under the HSR Act has expired or been terminated;
- **Canadian Competition Bureau clearance:** Canadian Competition Bureau clearance has been satisfied;
- **ICCC clearance:** the ICCC has confirmed in writing that it has cleared the Transaction under section 81 of the *Independent Consumer and Commission Act 2002*, either unconditionally or on terms that Newmont considers to be acceptable (acting reasonably);
- **Other Competition Approvals:** the Competition Approvals are obtained, either unconditionally or on terms that Newmont considers to be acceptable (acting reasonably);
- **Other regulatory approvals:** all other approval waivers, consents, exemptions or declarations of a Government Agency that Newcrest and Newmont agree are necessary or desirable to implement the Scheme are granted, given, made or obtained, in each case, either unconditionally or on terms that Newmont considers to be acceptable (acting reasonably) and those approvals or waivers have not been withdrawn, cancelled, varied or revoked;
- **Restraints:** no restraining order, injunction or other order that would restrain, prohibit or prevent the Scheme issued by a Government Agency (including any court of competent jurisdiction), is in effect at 8.00am on the Second Court Date;
- **Newmont Stockholder approval:** the Newmont Stockholder Resolution is approved by Newmont Stockholders as required by the Delaware General Corporation Law and NYSE Listing Rule 312.03;
- **Newcrest Shareholder approval:** the Requisite Majorities of Newcrest Shareholders approve the Scheme at the Scheme Meeting;
- **Newcrest Equity Incentives:** Newcrest has done all things and taken all necessary steps by 8.00am on the Second Court date to ensure that, before the Scheme Record Date, all Newcrest Equity Incentives vest or lapse, as contemplated by the Scheme Implementation Deed;
- **Independent Expert:** the Independent Expert does not change its conclusion that the Scheme is in the best of interests of Newcrest Shareholders before 8.00am on the Second Court Date;
- **Court approval:** the Court approves the Scheme in accordance with section 411(4)(b) of the Corporations Act;
- **No Newcrest Material Adverse Change:** no Newcrest Material Adverse Change occurs between 15 May 2023 and 8.00am on the Second Court Date;
- **No Newmont Material Adverse Change:** no Newmont Material Adverse Change occurs, between 15 May 2023 and 8.00am on the Second Court Date;
- **No Newcrest Prescribed Occurrence:** no Newcrest Prescribed Occurrence occurs between 15 May 2023 and 8.00am on the Second Court Date;
- **No Newmont Prescribed Occurrence:** no Newmont Prescribed Occurrence occurs between 15 May 2023 and 8.00am on the Second Court Date;
- **ASX Quotation:** the Newmont CDIs have been approved for official quotation on ASX before 8.00am on the Second Court Date;
- **NYSE listing:** the Newmont Shares have been approved for listing on NYSE before 8.00am on the Second Court Date;
- **ATO Class Ruling:** before 8.00am on the Second Court Date, Newcrest has received confirmation from the ATO that it is prepared to issue a Class Ruling for Roll-Over Relief; and
- **Securities Act Exemption:** the Newmont Shares to be issued pursuant to the Scheme (which may be represented by Newmont CDIs or Newmont PDIs) shall be exempt from the registration requirements of the Securities Act pursuant to section 3(a)(10) thereof.

Newmont has sought confirmation from the Securities Commission of PNG (**SCPNG**) that (i) it will not take action under certain sections of the Capital Market Act 2015 in respect of the Scheme and (ii) Newmont can rely on exemptions therefrom. Newmont has sought such confirmation from the SCPNG and is in continuing communication and discussions with the SCPNG.

11. Additional information

11.4 Scheme Implementation Deed *continued*

c) Conduct of business (clauses 6 and 7)

The Scheme Implementation Deed requires that Newcrest carry on its business and operations in the ordinary and usual course. In addition, subject to some exceptions, Newcrest must not undertake certain specific activities relating to the conduct of its business without the consent of Newmont. The Newcrest conduct of business restrictions are set out in full in clause 6 of the Scheme Implementation Deed.

The Scheme Implementation Deed also requires that Newmont carry on its business and operations in the ordinary and usual course. The Newmont conduct of business restrictions are set out in full in clause 7 of the Scheme Implementation Deed.

d) Representations and warranties (clause 10)

The Scheme Implementation Deed contains customary representations and warranties for a transaction similar to the Scheme, which are given by each of Newcrest and Newmont to each other. Certain representations and warranties are also given by Newmont Overseas.

These representations and warranties are set out in schedule 1 (in the case of Newcrest), schedule 2 (in the case of Newmont) and schedule 3 (in the case of Newmont Overseas) of the Scheme Implementation Deed.

e) Exclusivity (clause 14)

The Scheme Implementation Deed contains the following customary exclusivity provisions applicable to both Newcrest and Newmont:

- **no shop:** both parties must not directly or indirectly solicit a Competing Proposal;
- **no talk:** both parties must not participate in any discussions or provide certain information which would reasonably be expected to lead to (or encourage) a Competing Proposal;
- **no due diligence:** both parties must not participate in negotiations or discussions which would reasonably be expected to facilitate due diligence investigations (including through the provision of non-public information) in connection with a Competing Proposal; and
- **notification obligation:** both parties must notify the other party if they are approached with a Competing Proposal as soon as reasonably practicable (and in any event within 24 hours) and provide all material terms of the Competing Proposal.

The no talk and no due diligence provisions do not restrict Newcrest and Newmont from taking any action or inaction in respect of a Competing Proposal to the extent that the Newcrest or Newmont board (as applicable) determines (acting in good faith and after receiving external advice) that the Competing Proposal could reasonably be considered to become a Superior Proposal or Newmont Superior Proposal (as applicable), and failing to take or not take such action would likely breach the fiduciary or statutory duties of Newcrest's or Newmont's board members (as applicable).

In addition to the above, Newmont is provided a matching right. Under this right, Newcrest is prohibited from entering into an agreement to undertake or give effect to a Newcrest Competing Proposal and any member of the Newcrest Board is prohibited from withdrawing, changing, modifying or qualifying their recommendation in favour of the Scheme in response to or in connection with an actual Newcrest Competing Proposal, unless Newcrest has given Newmont at least 5 Business Days to provide an equivalent or superior proposal. Newcrest does not have a matching right.

These exclusivity provisions are set out in full in clause 14 of the Scheme Implementation Deed.

f) Break fee (clause 15)

Newcrest has agreed to pay Newmont a break fee of \$174,058,275 which will be payable if:

- any member of the Newcrest Board changes his or her recommendation in relation to the Scheme, except as a result of:
 - > the Independent Expert concluding that the Scheme is not in the best interests of Newcrest Shareholders; or
 - > Newcrest being entitled to terminate the Scheme Implementation Deed for material breach by Newmont of the Scheme Implementation Deed, including a breach of representations and warranties given by Newmont;
- a Newcrest Competing Proposal is announced and completes within 18 months of the date of such announcement; or
- Newmont terminates the Scheme Implementation Deed following a material breach by Newcrest, including of Newcrest's representations and warranties.

The break fee is not payable if the Scheme does not proceed solely because Newcrest Shareholders do not vote in favour of the Scheme by the Requisite Majorities at the Scheme Meeting.

Where the break fee is paid, neither Newmont nor any of its Related Bodies Corporate may make any claim whatsoever against Newcrest (including any claims for specific performance, injunctive relief or damages), to the maximum extent permitted by law.

11.4 Scheme Implementation Deed *continued*

g) Reverse break fee (clause 16)

Newmont has agreed to pay Newcrest a reverse break fee of \$374,766,240 which will be payable if:

- any member of the Newmont Board changes his or her recommendation in relation to the Scheme, except as a result of Newmont being entitled to terminate the Scheme Implementation Deed for material breach by Newcrest of the Scheme Implementation Deed, including a breach of representations and warranties given by Newcrest;
- a Newmont Competing Proposal is announced and completes within 18 months of the date of such announcement;
- Newcrest terminates the Scheme Implementation Deed following a material breach by Newmont, including of Newmont's representations and warranties; or
- the Scheme becomes Effective but Newmont or Newmont Overseas does not pay the Scheme Consideration in accordance with the Scheme Implementation Deed, the Scheme and the Deed Poll.

Newmont has also agreed to reimburse Newcrest for third party costs and expenses actually incurred by any Newcrest Group Member during the period commencing 14 January 2023 (being the date that Newcrest received the first approach from Newmont) until the Newmont Stockholder Meeting in connection with the Transaction, if the Scheme Implementation Deed is terminated due to failure to satisfy the Newmont Stockholder approval.

Where the reverse break fee is paid, neither Newcrest nor any of its Related Bodies Corporate may make any claim whatsoever against Newmont (including any claims for specific performance, injunctive relief or damages), to the maximum extent permitted by law.

h) Termination (clause 17)

Each of Newcrest and Newmont may terminate the Scheme Implementation Deed:

- for material breach of the Scheme Implementation Deed, including material breach of a representation and warranty (and that breach has not been remedied within 10 Business Days or any shorter period ending at 5.00pm on the Business Day before the Second Court Date);
- for failure of a Condition Precedent (as outlined in section 11.4(b)); or
- if the Scheme is not Effective by 15 February 2024.

Newcrest may terminate the Scheme Implementation Deed before 8.00am on the Second Court Date if:

- for any reason any member of the Newmont Board:
 - > changes, withdraws, modifies, revises or qualifies their support of the Scheme or their recommendation that Newmont Stockholders vote in favour of the Newmont Stockholder Resolution; or
 - > makes a public statement indicating that they no longer recommend the Transaction or they recommend, endorse or support a Newmont Competing Proposal; or
- Newcrest has received a Newcrest Competing Proposal and the Newcrest Board has determined (after Newmont exercises its matching right under the Scheme Implementation Deed) that the Newcrest Competing Proposal constitutes a Superior Proposal.

Newmont may terminate the Scheme Implementation Deed before 8.00am on the Second Court Date if for any reason, any member of the Newcrest Board:

- changes, withdraws, modifies, revises or qualifies their support of the Scheme or their recommendation that Newcrest Shareholders should vote in favour of the Scheme; or
- makes a public statement indicating that they no longer recommend the Scheme or they recommend, endorse or support a Newcrest Competing Proposal.

11. Additional information

11.5 Ineligible Foreign Shareholders and Sale Facility

Ineligible Foreign Shareholders are Newcrest Shareholders whose address shown in the Newcrest Share Register at the Scheme Record Date is in a place outside Australia and its external territories, Canada, New Zealand, PNG, the United Kingdom, the United States, the European Union (excluding Austria), Guernsey, Hong Kong, Japan, Norway, Singapore, South Korea, Switzerland, the United Arab Emirates, the Isle of Man and Bermuda.

Nominees, custodians and other Newcrest Shareholders who hold Newcrest Shares on behalf of a beneficial owner resident outside Australia and its external territories, Canada, New Zealand, Papua New Guinea, the United Kingdom, the United States, Guernsey, Hong Kong, Singapore, Switzerland, the United Arab Emirates (excluding financial zones), the Isle of Man and Bermuda may not forward this Scheme Booklet (or any accompanying document) to anyone outside these countries without the consent of Newcrest, except nominees, custodians and other Newcrest Shareholders may forward the Scheme Booklet to any beneficial shareholder that:

- in the European Union (excluding Austria), is a “qualified investor” (as defined in Article 2(e) of Regulation (EU) 2017/1129 of the European Parliament and the Council of the European Union);
- in Norway, is a “professional client” as defined in Norwegian Securities Trading Act of 29 June 2007 no. 75; or
- in South Korea, is an “accredited investor” as defined under the Financial Investment Services and Capitals Markets Act of Korea.

Newcrest Shareholders who are Ineligible Foreign Shareholders will not receive Newmont Securities. Instead, the Newmont Shares that would otherwise have been issued to the Ineligible Foreign Shareholder will be issued to the Sale Agent.

Newmont Overseas will procure, as soon as reasonably practicable after the Implementation Date (and in any event within 15 days of the date on which Newmont Shares are capable of being traded on NYSE) that the Sale Agent sells or procures the sale of the Newmont Shares issued to the Sale Agent in the ordinary course of trading on NYSE and in such manner, at such price and on such other terms as the Sale Agent (or their nominee) reasonably determines.

The Sale Agent will then remit the Net Cash Proceeds of the Sale Facility to Newmont Overseas as soon as reasonably practicable (and in any event within 10 Business Days settlement of the sale). Newmont Overseas will then promptly pay, or procure the payment to, Ineligible Foreign Shareholders of their pro rata proportion of the Net Cash Proceeds (in cash) in Australian dollars (as described further below).

The amount of money received by each Ineligible Foreign Shareholder will be calculated on an averaged basis so that all Ineligible Foreign Shareholders will receive the same price per Newmont Share, subject to rounding down to the nearest whole cent. Consequently, the amount received by Ineligible Foreign Shareholders for each Newmont Share may be more or less than the actual price that is received by the Sale Agent for that the sale of any particular Newmont Share.

As the market price of Newmont Shares will be subject to change from time to time, the sale price of those Newmont Shares, and the proceeds of those sales, cannot be guaranteed. Ineligible Foreign Shareholders will be able to obtain information on the market price of Newmont Shares on Newmont’s website (www.newmont.com).

The Net Cash Proceeds will be remitted to Newmont Overseas for distribution of the applicable pro rata portion to each Ineligible Foreign Shareholder by:

- electronic means to the nominated Australian dollar bank account with any Australian ADI (as defined in the Corporations Act) of the Ineligible Foreign Shareholder as noted on the Newcrest Share Register on the Scheme Record Date; or
- if an Ineligible Foreign Shareholder has not provided an account:
 - > sending a cheque in Australian dollars by mail to the Ineligible Foreign Shareholder’s registered address as at the Scheme Record Date; or
 - > and the Ineligible Shareholder has, before the Scheme Record Date, made a valid election in accordance with the requirements of the Newcrest Share Registry to receive dividend payments from Newcrest by electronic funds transfer, the Net Cash Proceeds will be remitted by electronic funds transfer to the bank account nominated by the Ineligible Foreign Shareholder, paying, or procuring the payment of, the relevant amount in Australian dollars in accordance with that election.

Interest will not be paid on any Net Cash Proceeds. The payment of the Net Cash Proceeds from the sale of the Newmont Shares will be in full satisfaction of the rights of Ineligible Foreign Shareholders.

In providing services to Newmont Overseas in connection with the Sale Facility, the Sale Agent is not acting as agent or sub agent of any Ineligible Foreign Shareholder, does not have any duties or obligations (fiduciary or otherwise) to Ineligible Foreign Shareholders and does not underwrite the sale of any Newmont Shares.

Newcrest ADS Holders will not participate in the Sale Facility.



11.6 Exempt Issuer Listing on PNGX and Newmont PDIs

a) Background

Newmont intends to apply for admission to the Official List of PNGX as an Exempt Issuer Listing, subject to customary conditions and the Scheme becoming Effective.

Once listed on the PNGX as an Exempt Issuer Listing, Newmont will be exempt from complying with most of the PNGX Listing Rules. However, PNGX Listing Rules with regard to Exempt Issuer Listings will apply to Newmont, including:

- continuing to comply with the NYSE Listing Rules;
- providing PNGX with copies of its public filings;
- registering as an overseas company under the PNG Companies Act and certification as a foreign enterprise under the Investment Promotion Act;
- complying with certain PNGX Listing Rules concerning procedural and administrative matters, including giving information to the PNGX and securities holders in addition to copies of public filings, lodging announcements, transfers and registrations of securities, payment of fees, trading halts, and suspension and removal.

Scheme Shareholders, other than Ineligible Foreign Shareholders,⁶⁰ who hold their Scheme Shares on the PNG Register will receive PNGX-listed PETS Depositary Interests (**PDIs**) as Scheme Consideration.

b) PETS Depositary Interests

1) Overview

PDIs are a type of depository receipt, used to enable trading on the PNGX of financial products issued by entities domiciled in countries whose laws may not recognise uncertificated holders or electronic transfer of title through PETS (**Port Moresby Electronic Trading System**). Under the operating rules for the PETS facility, this allows the PDI holder to obtain all the economic benefits attaching to the underlying securities without actually holding legal title to them. When PDIs are quoted on the PNGX, the underlying securities are regarded as having been quoted on the PNGX.

A PDI represents a unit of beneficial ownership in an underlying security that is held on trust for the PDI holder by PDN. PDN is (or in advance of the Implementation Date) will be appointed under the PNGX Business Rules to hold the Newmont Shares that underlie the PDIs as agent for the PDI holders.

Newmont will issue the Newmont Shares to which the Newmont PDIs relate to PDN, who will hold legal title to those Newmont Shares on behalf of the holders of the Newmont PDI holders. PDN will issue the Newmont PDIs to relevant Scheme Shareholders in parallel.

Newmont PDIs would be quoted and traded on the PNGX in the Papua New Guinean currency of Kina (**PGK**) and traded under the symbol "NEM". Newmont PDIs would not be quoted or traded on NYSE, TSX or ASX. This allows investors to trade interests in foreign securities on the PNGX by trading the relevant PDIs. If a holder of Newmont PDIs wishes to trade on the NYSE or the TSX, they must transmute the Newmont PDIs into Newmont Shares by contacting the Newmont PDI Registry. The Newmont PDI Registry will not charge a fee to a Newmont PDI holder seeking to transmute Newmont PDIs to Newmont Shares, although a cross-border transaction fee may be charged by intermediaries (see section 11.6(b)(2)). If a holder of Newmont PDIs wishes to trade on the ASX, they must transmute the Newmont PDIs into Newmont Shares and then transmute the Newmont Shares into Newmont CDIs (see section 7.8(c)(10)).

Deferred settlement trading of Newmont PDIs is expected to be available on the PNGX from Friday, 27 October 2023. Newmont PDIs are expected to commence trading on the PNGX on a normal settlement basis on the PNGX from Tuesday, 7 November 2023.

60. Ineligible Foreign Shareholders will receive their pro rata share of the Net Cash Proceeds. See sections 4.5 and 11.5 for further details.

11. Additional information

11.6 Exempt Issuer Listing on PNGX and Newmont PDIs *continued*

2) Key features

Each Newmont PDI will represent a unit of beneficial interest in a Newmont Share.

Subject to certain exceptions noted in this section, the rights attached to Newmont PDIs are economically equivalent to the rights attaching to a Newmont Share, and Newmont will generally be required to treat holders of Newmont PDIs as if they were holders of the Newmont Shares represented by those Newmont PDIs.

Newmont PDIs have similar key features to Newmont CDIs as set out in section 7.8(c) and similar differences to Newmont Shares as set out in 7.8(d), other than:

- Newmont PDIs will be tradeable only on the PNGX. This may be attractive to Newcrest Shareholders, as it allows Newmont PDIs to be traded during PNG business hours using PNG brokers in prices quoted in PGK.
- As holders of Newmont PDIs are not registered Newmont Stockholders, the rights attaching to Newmont Shares which underlie their Newmont PDIs must be exercised by PDN. A holder of Newmont PDIs may instruct PDN to exercise those rights on their behalf.
- As holders of Newmont PDIs are not registered holders of the Newmont Shares represented by Newmont PDIs, they will not be automatically entitled to vote at a meeting of Newmont Stockholders. However, the holder of a Newmont PDI can direct PDN to cast votes in a particular manner to exercise the votes attaching to the Newmont Shares represented by the holder's Newmont PDIs.
- Under the PNGX Business Rules in force as at the date of this Scheme Booklet, PDN will not accept a takeover offer in respect of any Newmont PDIs representing Newmont Shares unless authorised to do so by holders of Newmont PDIs. It is PDN's responsibility to ensure that the bidder receives and processes (either itself or via a receiving agent in PNG) those acceptances.
- If Newmont PDIs are issued to you under the Scheme, you will receive a holding statement or confirmation advice in respect of your Newmont PDIs rather than a holding statement for the underlying Newmont Shares. Revised holding statements will be provided on a periodic basis if there is a change in the number of Newmont PDIs held by you. Newmont PDIs may be held on an issuer sponsored subregister or on a PETS subregister. Newmont PDIs issued under the Scheme will be received on the Newmont PDI issuer sponsored subregister.
- The price of Newmont PDIs will be subject to, and reflect movements in, the Newmont Share price and the PGK:USD exchange rate (whereas the price of Newmont CDIs will be subject to, and reflect movements in, the Newmont Share price and the AUD:USD exchange rate).
- Newcrest Shareholders that receive Newmont Shares, and existing Newmont Stockholders, may at any time (following the Implementation Date) transmute them into Newmont PDIs by contacting the Newmont Share Registry. The Newmont Share Registry will not charge a fee to a shareholder seeking to transmute Newmont Shares to Newmont PDIs, although a cross-border transaction fee may be charged by intermediaries. In this instance, underlying Newmont Shares will be transferred to PDN and a holding statement for the Newmont PDIs will be issued to the relevant security holder. No trading in Newmont PDIs on the PNGX can take place until this conversion process is complete. The decision whether to transmute Newmont Shares to Newmont PDIs will depend on your individual circumstances. You should seek advice from your own independent and appropriately licensed financial, legal and tax adviser before deciding whether to transmute Newmont Shares to Newmont PDIs.
- Under the PNGX Business Rules in force as at the date of this Scheme Booklet, Newmont will make the PDI Register available for inspection to the same extent and in the same manner as if that register were a register of securities of a Papua New Guinean listed public company under the PNG Capital Market Act. Such PDI Register will be an interests register and will be available for inspection by a person who serves on Newmont a written notice of an intention to inspect, at the place at which the register is kept, between the hours of 9 am and 5 pm on each working day during the inspection period.
- In accordance with the PNGX Business Rules in force as at the date of this Scheme Booklet, Newmont will distribute any dividend declared on Newmont Shares directly to holders of Newmont PDIs. Dividend record and payment dates will be the same for Newmont Shares and Newmont PDIs. See section 7.3(d) for further details on Newmont's intentions in relation to dividends.
- Newmont will communicate directly with holders of Newmont PDIs with respect to corporate actions. To the extent practicable, Newmont will send notices and other documents (e.g. notices of meetings) to holders of Newmont PDIs at the same time as they are sent to Newmont Stockholders. Newmont will administer all corporate actions that result in either (1) the issue of additional or replacement Newmont Shares; or (2) the cancellation, buy-back or other reduction in number by whatever means of Newmont Shares (whether in whole or in part), as if each the holder of Newmont PDIs is a holder of the underlying Newmont Shares held by PDN. The record and action dates for the corporate action will be the same for Newmont Shares and Newmont PDIs. If the laws of Delaware do not permit Newmont to administer a corporate action in the manner described above, Newmont will, to the extent permitted by law and approved by the PNGX, administer an alternative proposal to place holders of Newmont PDIs as nearly as practicable in the same economic position as a result of the corporate action as if Newmont had administered the action in the manner described above.
- Newmont will make any dividend investment scheme or bonus share plans, that are available to Newmont Stockholders, also available to holders of Newmont PDIs. Newmont will ensure that holders of Newmont PDIs can exercise any rights under those plans (rather than PDN) and any benefits of the plans provided to PDN are distributed to the holders of Newmont PDIs.



11.6 Exempt Issuer Listing on PNGX and Newmont PDIs *continued*

c) Risks of Newmont PDIs

1) Similar risks to Newmont CDIs

Newmont PDIs have similar risks to Newmont CDIs as set out in section 8.3, other than:

- As Papua New Guinea is a developing country, PNGX is a stock exchange located in an emerging market set within a reactive political landscape. As a result of this, the PNGX and its Rules may be liable to review and overhaul. This recently occurred with the introduction of a new suite of PNGX Listing Rules which came into effect on 3 July 2023. As the PNGX currently has only 12 companies listed, these new PNGX Listing Rules are largely yet to be tested in practice and, as the PNGX has complete discretion over any application for listing, a risk of uncertainty arises as to their application, particularly in respect of PDIs, as changes to the PNGX Business Rules addressing PDI's were not included in the recent suite of amendments. Newmont understands that changes to the PNGX Business Rules and further changes to the PNGX Listing Rules will be made in the near-term, including in respect of PDIs and including to facilitate the admission of Newmont to the Official List of PNGX as an Exempt Issuer and the quotation of Newmont PDIs on the basis contemplated by this Scheme Booklet. In addition, it is possible that further changes to the PNGX Listing Rules or the PNGX Business Rules will be made in the future, either in respect of PDIs or more generally. Based on engagement with PNGX as at the date of this Scheme Booklet, Newmont expects that any near-term changes to the PNGX Listing Rules or the PNGX Business Rules will be largely consistent with the regime that applies with respect to ASX-listed CDIs (see section 7.8). Uncertainty created as a result of changing or untested PNGX Listing Rules or PNGX Business Rules may give rise to delays in actions sought to be taken by Newmont, by PDN or by Newmont PDI holders, and any new compliance requirements may impact on the desirability of Newmont PDIs as a security.
- As noted above, the PNGX is a small market with only 12 companies currently listed, resulting in limited liquidity. Newmont does not know the extent to which investor interest will lead to the development of an active trading market for the Newmont PDIs or how liquid that market may become. If the Newmont PDIs are traded after their initial issuance, they may trade at a price lower than the price at which they trade on initial listing. Once the Newmont PDIs are quoted on the PNGX, there can be no guarantee that an active trading market for the Newmont PDIs will develop or that the price of the Newmont PDIs will increase. There may be relatively few potential buyers or sellers of the Newmont PDIs on the PNGX at any time. This may increase the volatility of the market price of the Newmont PDIs. It may also affect the prevailing market price at which shareholders are able to sell their Newmont PDIs. This may result in shareholders receiving a market price for their Newmont PDIs that is less than the price that the shareholders paid.

2) No guarantee that Newmont will be listed on the PNGX

There is no guarantee that:

- Newmont will be listed on the PNGX as an Exempt Issuer prior to implementation of the Scheme, or at all;
- deferred settlement trading of Newmont PDIs will be available on the PNGX from 27 October 2023; or
- Newmont PDIs will commence trading on the PNGX on a normal settlement basis on the PNGX from 7 November 2023.

As such, there is a risk that relevant Scheme Shareholders who receive Newmont Shares may not be able to trade their resulting Newmont PDIs on the PNGX or otherwise if Newmont does not successfully establish and does not maintain an Exempt Issuer Listing on the PNGX. In these circumstances, there may be adverse consequences for Scheme Shareholders who previously traded Newcrest Shares on the PNGX and who will not be able to trade their Newmont PDIs on the PNGX, including foreign exchange restrictions, adverse taxation consequences and liquidity consequences.

11. Additional information

11.7 Newcrest ADSs

ADSs representing Newcrest Shares are traded in the United States. Each Newcrest ADS represents one Newcrest Share.

Subject to the terms of the Deposit Agreement, the Depositary will fix a voting record date in respect of the Scheme Meeting (**ADS Record Date**). The Depositary will mail to Newcrest ADS Holders that are registered on the Depositary's books a voting instruction card containing (i) a notice of meeting and solicitation of consent or proxy and (ii) a statement that the Newcrest ADS Holders at the close of business on the ADS Record Date set by the Depositary will be entitled, subject to any applicable law, the provisions of the Deposit Agreement and Newcrest's constitutional documents, to instruct the Depositary as to the exercise of the voting rights pertaining to the amount of Newcrest Shares represented by their Newcrest ADSs and (iii) information on where this Scheme Booklet can be accessed and how to request a paper copy of it. Upon the timely receipt of voting instructions of a registered Newcrest ADS Holder in the manner specified by the Depositary, the Depositary will endeavour, insofar as practicable and permitted under applicable law, the provisions of the Deposit Agreement and Newcrest's constitutional documents, to vote or cause the custodian for the Depositary to vote the amount of Newcrest Shares (in person or by proxy) represented by that holder's Newcrest ADSs at the Scheme Meeting in accordance with such voting instructions. Newcrest ADS Holders should contact the Depositary for any additional information, including on how to give voting instructions to the Depositary. Persons holding Newcrest ADSs in accounts with a bank, broker, nominee or other security intermediary should receive directions from such bank, broker, nominee or other securities intermediary as to how they can give voting instructions and information on the applicable cut-off dates and times for receipt of those instructions. A copy of the Deposit Agreement is available free of charge at the SEC's website at www.sec.gov.

Newcrest ADS Holders who wish to attend or vote at the Scheme Meeting (rather than instruct the Depositary to vote the Newcrest Shares underlying their Newcrest ADSs on their behalf) must ensure that they surrender their Newcrest ADSs for cancellation in accordance with the terms of the Deposit Agreement and are registered as Newcrest Shareholders on the Scheme Record Date. Registered Newcrest ADS Holders should contact the Depositary for any additional information. Persons holding Newcrest ADSs through banks, brokers, nominees or other securities intermediaries should contact such banks, brokers, nominees or other securities intermediaries for any additional information.

If the Scheme is implemented, all Newcrest Shares, including those underlying Newcrest ADSs will automatically be transferred to Newmont Overseas in exchange for the Scheme Consideration. In connection with these arrangements, Newcrest has instructed the Depositary to deliver Newmont Shares directly to Newcrest ADS Holders, in proportion to the number of Newcrest ADSs held by them upon surrenders by them of their Newcrest ADSs. Persons holding Newcrest ADSs in accounts with banks, brokers, nominees or other securities intermediaries will have Newmont Shares credited to their accounts without having to take any action. Persons holding Newcrest ADSs in uncertificated form as registered holders on the Depositary's books will be deemed to have surrendered their Newcrest ADSs on the Implementation Date and will have uncertificated Newmont Shares registered in their names without having to take any action. Persons holding Newcrest ADSs in certificated form as registered holders on the Depositary's books will receive from the Depositary a letter of transmittal form, which must be signed and returned together with the American Depositary Receipts (ADRs) evidencing the relevant Newcrest ADSs who will cause Newmont Shares in uncertificated form to be registered in their names.

As part of these arrangements, Newcrest has instructed the Depositary to terminate its ADR program promptly following implementation of the Scheme. Newcrest ADS Holders will receive notice of termination from the Depositary, and the termination will be effective as of the termination date specified in the notice. Newcrest has agreed to pay the Depositary all fees and expenses owing in connection with the termination of the Deposit Agreement including the cancellation fees that would otherwise be paid by Newcrest ADS Holders.

11.8 United States Securities Act

The Newmont Shares to be issued pursuant to the Scheme (which may be represented by Newmont CDIs or Newmont PDIs) have not been and will not be registered under the Securities Act or the securities laws of any state, district or other jurisdiction of the United States. Newmont intends to rely on an exemption from the registration requirements of the Securities Act provided by section 3(a)(10) thereof on the basis of the approval of the Court, which will consider, among other things, the fairness of the terms and conditions of the issuance and exchange of the Newmont Shares to be issued pursuant to the Scheme (which may be represented by Newmont CDIs or Newmont PDIs) to Newcrest Shareholders. For the purposes of qualifying for the section 3(a)(10) exemption, Newcrest will advise the Court that its approval of the Scheme will be relied upon by Newmont as an approval of the Scheme following a hearing on the fairness of the terms and conditions of the Scheme to Newcrest Shareholders, which hearing all Newcrest Shareholders are entitled to attend in person or through their duly appointed proxies or through counsel to support or oppose the approval of the Scheme and with respect to which hearing notification has been given to all Newcrest Shareholders.

The Newmont Shares to be issued pursuant to the Scheme (which may be represented by Newmont CDIs or Newmont PDIs) will be freely transferable under United States federal securities laws, except by Newcrest Shareholders (whether or not US persons (as defined under the Securities Act)) who are deemed to be "affiliates" (as defined under the Securities Act) of Newmont, including persons who are deemed to have been affiliates of Newmont within 90 days before the Implementation Date. In the event that such Newmont Shares to be issued pursuant to the Scheme (which may be represented by Newmont CDIs or Newmont PDIs) are in fact held by affiliates of Newmont, such affiliates may resell the shares (a) in accordance with the provisions of Rule 144 promulgated under the Securities Act or (b) as otherwise permitted under the Securities Act. Under the Securities Act, persons who may be deemed to be "affiliates" of an issuer generally include individuals or entities that control, are controlled by or are under common control with the issuer, whether through the ownership of voting securities, by contract, or otherwise, and generally include officers and directors of the issuer as well as principal shareholders of the issuer. Any resale of Newmont Shares to be issued pursuant to the Scheme (which may be represented by Newmont CDIs or Newmont PDIs) by such an "affiliate" or former "affiliate" may be subject to the registration requirements of the Securities Act, absent an exemption therefrom, such as the exemption contained in Rule 144.



11.9 Foreign disclaimers

No action has been taken to register or qualify the Newmont Securities or otherwise permit a public offer of such securities in any jurisdiction outside Australia.

Based on the information available to Newmont, Newcrest Shareholders whose addresses are shown in the register on the record date for the Scheme as being in the following jurisdictions will be entitled to receive this Scheme Booklet and have the Newmont Securities issued to them under the Scheme subject to any qualifications set out below in respect of that jurisdiction:

- Australia;
- Bermuda;
- Canada;
- European Union (excluding Austria), where (i) the Newcrest shareholder is a “qualified investor” (as defined in Article 2(e) of the Regulation (EU) 2017/1129 of the European Parliament and the Council of the European Union) or (ii) the number of other Newcrest shareholders is less than 150;
- Guernsey;
- Hong Kong;
- Isle of Man;
- Japan, where the number of Newcrest Shareholders is less than 50;
- New Zealand;
- Norway, where (i) Newcrest shareholders are “professional clients” or (ii) the number of non-professional clients is less than 150;
- PNG;
- Singapore;
- South Korea where (i) Newcrest Shareholders are “accredited investors” (as defined in the Financial Investment Services and Capitals Markets Act of Korea) or (ii) the number of other Newcrest Shareholders is less than 50;
- Switzerland;
- United Arab Emirates, to all Newcrest Shareholders outside the financial zones and to less than 50 persons who are Newcrest Shareholders in each of the Abu Dhabi Global Market and Dubai International Financial Centre;
- United Kingdom; and
- United States.

Nominees and custodians who hold Newcrest Shares on behalf of a beneficial owner resident outside Australia, Bermuda, Canada, Guernsey, Hong Kong, Isle of Man, New Zealand, Singapore, Switzerland, United Arab Emirates (excluding financial zones), PNG, United Kingdom and the United States may not forward this Scheme Booklet (or any accompanying document) to anyone outside these countries without the consent of Newcrest except nominees and custodians may forward the Scheme Booklet to any beneficial shareholder that:

- in the European Union (excluding Austria), is a “qualified investor” (as defined in Article 2(e) of the Regulation (EU) 2017/1129 of the European Parliament and the Council of the European Union);
- in Norway, is a “professional client” as defined in Norwegian Securities Trading Act of 29 June 2007 no. 75; or
- in South Korea, is an “accredited investor” as defined under the Financial Investment Services and Capitals Markets Act of Korea.

a) Bermuda

No offer or invitation to subscribe for Newmont Securities may be made to the public in Bermuda. No invitation is being made to persons resident in Bermuda for exchange control purposes to subscribe for Newmont Shares or the Newmont Securities.

b) Canada

The Newmont Securities will be issued by Newmont in reliance upon exemptions from the prospectus and registration requirements of the applicable Canadian securities law in each province and territory of Canada.

No securities commission in Canada has reviewed or in any way passed upon this document or the merits of the Scheme.

11. Additional information

11.9 Foreign disclaimers *continued*

c) European Union

This Scheme Booklet is not a prospectus under Regulation (EU) 2017/1129 of the European Parliament and the Council of the European Union (the **Prospectus Regulation**). Therefore, the Scheme Booklet has not been, and will not be, registered with or approved by any securities regulator in the European Union. Accordingly, this Scheme Booklet may not be made available, nor may the Newmont Securities be offered for sale or exchange, in the European Union and Liechtenstein except in circumstances that do not require the obligation to publish a prospectus under the Prospectus Regulation.

In accordance with Article 1(4) of the Prospectus Regulation, an offer of Newmont Securities in each member state of the European Union and Liechtenstein is limited:

- to persons who are “qualified investors” (as defined in Article 2(e) of the Prospectus Regulation);
- to fewer than 150 other natural or legal persons (excluding Austria); and
- in any other circumstance falling within Article 1(4) of the Prospectus Regulation.

d) Guernsey

This Scheme Booklet may be distributed in the Bailiwick of Guernsey only to Newcrest Shareholders. No offer or invitation to subscribe for the Newmont Securities may be made to the public in the Bailiwick of Guernsey.

e) Hong Kong

WARNING: The contents of this Scheme Booklet have not been reviewed or approved by any regulatory authority in Hong Kong. You are advised to exercise caution in relation to the Scheme. If you are in any doubt about any of the contents of this Scheme Booklet, you should obtain independent professional advice.

This Scheme Booklet does not constitute an offer or invitation to the public in Hong Kong to acquire or subscribe for or dispose of any securities. This Scheme Booklet also does not constitute a prospectus (as defined in section 2(1) of the Companies (Winding Up and Miscellaneous Provisions) Ordinance (Cap. 32 of the Laws of Hong Kong)) or notice, circular, brochure or advertisement offering any securities to the public for subscription or purchase or calculated to invite such offers by the public to subscribe for or purchase any securities, nor is it an advertisement, invitation or document containing an advertisement or invitation falling within the meaning of section 103 of the Securities and Futures Ordinance (Cap. 571 of the Laws of Hong Kong).

Accordingly, unless permitted by the securities laws of Hong Kong, no person may issue or cause to be issued this Scheme Booklet in Hong Kong, other than to persons who are “professional investors” (as defined in the Securities and Futures Ordinance and any rules made thereunder) or in other circumstances that do not constitute an offer to the public within the meaning of the Companies (Winding Up and Miscellaneous Provisions) Ordinance.

No person may issue or have in its possession for the purposes of issue, this Scheme Booklet or any advertisement, invitation or document relating to these securities, whether in Hong Kong or elsewhere, which is directed at, or the contents of which are likely to be accessed or read by, the public in Hong Kong (except if permitted to do so under the securities laws of Hong Kong) other than any such advertisement, invitation or document relating to securities that are or are intended to be disposed of only to persons outside Hong Kong or only to professional investors.

Copies of this Scheme Booklet may be issued to a limited number of persons in Hong Kong in a manner that does not constitute any issue, circulation or distribution of this Scheme Booklet, or any offer or an invitation in respect of these securities, to the public in Hong Kong. This Scheme Booklet is for the exclusive use of Newcrest shareholders in connection with the Scheme. No steps have been taken to register or seek authorisation for the issue of this Scheme Booklet in Hong Kong.

This Scheme Booklet is confidential to the person to whom it is addressed and no person to whom a copy of this Scheme Booklet is issued may issue, circulate, distribute, publish, reproduce or disclose (in whole or in part) this Scheme Booklet to any other person in Hong Kong or use for any purpose in Hong Kong other than in connection with consideration of the Scheme by Newcrest Shareholders.

f) Isle of Man

No offer or invitation to subscribe for securities may be made to the public in the Isle of Man. The Newmont Securities may only be offered and issued to existing shareholders of Newcrest.

g) Japan

The Newmont Securities have not been, and will not be, registered under Article 4, paragraph 1 of the Financial Instruments and Exchange Law of Japan (Law No. 25 of 1948), as amended pursuant to an exemption from the registration requirements applicable to a private placement of securities to small number investors. This Scheme Booklet is for the exclusive use of existing Newcrest Shareholders in connection with the Scheme. This Scheme Booklet is confidential to the person to whom it is addressed and must not be distributed, published, reproduced or disclosed (in whole or in part) to any other person in Japan or resident of Japan other than in connection with consideration by Newcrest's Shareholders of the Scheme.



11.9 Foreign disclaimers *continued*

h) New Zealand

This Scheme Booklet is not a New Zealand disclosure document and has not been registered, filed with or approved by any New Zealand regulatory authority under or in accordance with the Financial Markets Conduct Act 2013 or any other New Zealand law. The offer of the Newmont Securities under the Scheme is being made to existing Newcrest Shareholders in reliance upon the Financial Markets Conduct (Incidental Offers) Exemption Notice 2021 and, accordingly, this Scheme Booklet may not contain all the information that a disclosure document is required to contain under New Zealand law.

i) Norway

This Scheme Booklet has not been approved by, or registered with, any Norwegian securities regulator under the Norwegian Securities Trading Act of 29 June 2007 no. 75, as amended. Accordingly, this Scheme Booklet shall not be deemed to constitute an offer to the public in Norway within the meaning of the Norwegian Securities Trading Act.

Newmont Securities may not be offered or sold in Norway except:

- to “professional clients” (as defined in the Norwegian Securities Trading Act);
- to fewer than 150 non-professional clients; or
- in any other circumstances provided that such offer of securities does not result in a requirement for the registration or the publication of a prospectus pursuant to the Norwegian Securities Trading Act.

j) PNG

WARNING: This Scheme Booklet has not been, and will not be, registered as a prospectus by the Securities Commission of Papua New Guinea and does not comply with the requirements or provisions pertaining to prospectuses of the Capital Market Act 2015 of the Independent State of PNG (**Capital Market Act 2015**). Accordingly, the Newmont Securities have not been, and will not be, offered in PNG other than in circumstances where the offer qualifies as an “excluded offer”, “excluded invitation” or “excluded issue” (as such terms are defined in the Capital Market Act 2015).

No advertisement, invitation or document relating to the Newmont Securities has been, or will be, issued in PNG or elsewhere that is directed at, or the contents of which are likely to be accessed or read by, the public of PNG (except if permitted to do so under the Capital Market Act 2015).

k) Singapore

This Scheme Booklet and any other document relating to the Scheme have not been, and will not be, registered as a prospectus with the Monetary Authority of Singapore and the Scheme is not regulated by any financial supervisory authority in Singapore. Accordingly, statutory liabilities in connection with the contents of prospectuses under the Securities and Futures Act 2001 (the **SFA**) will not apply.

This Scheme Booklet and any other document relating to the Scheme may not be made the subject of an invitation for subscription, purchase or receipt, whether directly or indirectly, to persons in Singapore except pursuant to exemptions in Subdivision (4) Division 1, Part 13 of the SFA, including the exemption under section 273(1)(c) of the SFA, or otherwise pursuant to, and in accordance with the conditions of, any other applicable provisions of the SFA.

Any offer is not made to you with a view to Newmont Securities being subsequently offered for sale to any other party in Singapore. You are advised to acquaint yourself with the SFA provisions relating to on-sale restrictions in Singapore and comply accordingly.

This Scheme Booklet is being furnished to you on a confidential basis and solely for your information and may not be reproduced, disclosed, or distributed to any other person. Any investment referred to in this Scheme Booklet may not be suitable for you and it is recommended that you consult an independent investment advisor if you are in doubt about such investment.

Neither Newcrest nor Newmont is in the business of dealing in securities or holds itself out, or purports to hold itself out, to be doing so. As such, Newcrest and Newmont are neither licensed nor exempted from dealing in securities or carrying out any other regulated activities under the SFA or any other applicable legislation in Singapore.

l) South Korea

Neither Newcrest nor Newmont are making any representation with respect to the eligibility of any recipients of this Scheme Booklet to acquire Newmont Securities under the laws of the Republic of Korea, including the Foreign Exchange Transaction Act and regulations thereunder. Newmont Securities have not been, and will not be, registered under the Financial Investment Services and Capital Markets Act of Korea (the **FSCMA**) and therefore may not be offered or sold in Korea or to any resident of Korea or to any persons for re-offering or resale in Korea or to any resident of Korea (as defined under the Foreign Exchange Transaction Act of Korea and its enforcement decree), except as permitted under the applicable laws and regulations of Korea.

Accordingly, the Newmont Securities may not be offered or sold in Korea other than (i) to “accredited investors” (as defined in the FSCMA) or (ii) in other circumstances that do not constitute an offer to the public within the meaning of the FSCMA.

11. Additional information

11.9 Foreign disclaimers *continued*

m) Switzerland

The Newmont Securities may not be publicly offered in Switzerland and will not be listed on the SIX Swiss Exchange or on any other stock exchange or regulated trading facility in Switzerland. Neither this Scheme Booklet nor any other offering material relating to the Newmont Securities constitutes a prospectus or a similar notice as such terms are understood pursuant to art. 35 of the Swiss Financial Services Act or the listing rules of any stock exchange or regulated trading facility in Switzerland. Neither this Scheme Booklet nor any other offering material relating to the Newmont Securities may be publicly distributed or otherwise made publicly available in Switzerland.

Neither this Scheme Booklet nor any other offering material relating to the Newmont Securities have been, or will be, filed with or approved by any Swiss regulatory authority or authorised review body. In particular, this Scheme Booklet will not be filed with, and the offer of the Newmont Securities will not be supervised by, the Swiss Financial Market Supervisory Authority.

This Scheme Booklet may be distributed in Switzerland only to existing shareholders of Newcrest and is not for general circulation in Switzerland.

n) United Arab Emirates

The Scheme Booklet does not constitute a public offer of securities in the United Arab Emirates (**UAE**) and the Newmont Securities may not be offered or sold, directly or indirectly, to the public in the UAE. Neither the Scheme Booklet nor the Newmont Securities have been approved by the Securities and Commodities Authority or any other authority in the UAE.

The Scheme Booklet may be distributed in the UAE only to existing shareholders of Newcrest and may not be provided to any person other than the original recipient. Information about the Scheme may be found in the Scheme Booklet, which is available on Newcrest's website. If a recipient of the Scheme Booklet ceases to be a shareholder of Newcrest at the time of subscription, then such person should discard the Scheme Booklet and may not participate in the Scheme.

No marketing of the Newmont Securities has been, or will be, made from within the UAE other than in compliance with the laws of the UAE and no subscription for any securities may be consummated within the UAE (excluding the Dubai International Financial Centre and the Abu Dhabi Global Market).

In the Abu Dhabi Global Market and the Dubai International Financial Centre, the Newmont Securities may be offered, and this Scheme Booklet may be distributed, only to existing Newcrest Shareholders as an "Exempt Scheme", as defined and in compliance with the market rules issued by the regulatory authorities in these financial zones. No regulatory authority has approved this Scheme Booklet nor taken any steps to verify the information set out in it.

o) United Kingdom

Neither this Scheme Booklet nor any other document relating to the Scheme has been delivered for approval to the Financial Conduct Authority in the United Kingdom and no prospectus (within the meaning of section 85 of the Financial Services and Markets Act 2000, as amended (**FSMA**)) has been published or is intended to be published in respect of the Newmont Securities.

This Scheme Booklet does not constitute an offer of transferable securities to the public within the meaning of the United Kingdom Prospectus Regulation or the FSMA. Accordingly, this Scheme Booklet does not constitute a prospectus for the purposes of the United Kingdom Prospectus Regulation or the FSMA.

Any invitation or inducement to engage in investment activity (within the meaning of section 21 FSMA) received in connection with the issue or sale of the Newmont Securities has only been communicated or caused to be communicated and will only be communicated or caused to be communicated in the United Kingdom in circumstances in which section 21(1) FSMA does not apply to Newcrest.

In the United Kingdom, this Scheme Booklet is being distributed only to, and is directed at, persons (i) who fall within Article 43 (members of certain bodies corporate) of the Financial Services and Markets Act 2000 (Financial Promotions) Order 2005, or (ii) to whom it may otherwise be lawfully communicated (together 'relevant persons'). The investments to which this Scheme Booklet relates are available only to, and any invitation, offer or agreement to purchase will be engaged in only with, relevant persons. Any person who is not a relevant person should not act or rely on this Scheme Booklet.

p) United States

Newmont intends to rely on an exemption from the registration requirements of the Securities Act provided by section 3(a)(10) thereof in connection with the issuance of the Newmont Shares to be issued pursuant to the Scheme (which may be represented by Newmont CDIs or Newmont PDIs). For the purposes of qualifying for the section 3(a)(10) exemption, Newcrest will advise the Court that its approval of the Scheme will be relied upon by Newmont as an approval of the Scheme following a hearing on the fairness of the terms and conditions of the Scheme to Newcrest Shareholders. All Newcrest Shareholders are entitled to attend such Court hearing in person or through their duly appointed proxies or through counsel to support or oppose the approval of the Scheme, and notification of such Court hearing has been given to all such Newcrest Shareholders.



11.9 Foreign disclaimers *continued*

United States Newcrest Shareholders should note that the Scheme is made for the securities of an Australian company in accordance with the laws of Australia and the ASX Listing Rules. The Scheme is subject to disclosure requirements of Australia that are different from those of the United States. The Newcrest Historical Financial Information included in this Scheme Booklet has been prepared in accordance with the recognition and measurement principles of AAS issued by the AASB, which are consistent with IFRS issued by the IASB and may not be comparable to the financial statements of US companies whose financial statements are prepared in accordance with generally accepted accounting principles in the United States.

This Scheme Booklet has not been filed with or reviewed by the SEC, any United States state securities commission or any other United States regulatory authority and none of them has approved or disapproved of the Newmont Shares to be issued pursuant to the Scheme (which may be represented by Newmont CDIs or Newmont PDIs) or passed upon or endorsed the merits of the Scheme or the accuracy, adequacy or completeness of this Scheme Booklet. Any representation to the contrary is a criminal offence.

The Newmont Shares to be issued pursuant to the Scheme (which may be represented by Newmont CDIs or Newmont PDIs) have not been and will not be registered under the Securities Act or the securities laws of any state, district or other jurisdiction of the United States. Such Newmont Shares to be issued pursuant to the Scheme (which may be represented by Newmont CDIs or Newmont PDIs) will be freely transferable under United States federal securities laws, except by Newcrest Shareholders (whether or not US persons (as defined in the Securities Act)) who are deemed to be "affiliates" (as that term is defined under the Securities Act) of Newmont, including persons who are deemed to have been affiliates of Newmont within 90 days before the Implementation Date. In the event that such Newmont Shares to be issued pursuant to the Scheme (which may be represented by Newmont CDIs or Newmont PDIs) are in fact held by affiliates of Newmont, such affiliates may resell the shares (i) in accordance with the provisions of Rule 144 promulgated under the Securities Act or (ii) as otherwise permitted under the Securities Act. Any resale of Newmont Shares to be issued pursuant to the Scheme (which may be represented by Newmont CDIs or Newmont PDIs) by such an "affiliate" or former "affiliate" may be subject to the registration requirements of the Securities Act, absent an exemption therefrom, such as the exemption contained in Rule 144.

11.10 Consents and disclosures

a) Consents

This Scheme Booklet contains statements or reports made by, or statements said to be based on statements or reports made by:

- Newmont in respect of the Newmont Information only;
- Grant Samuel & Associates Pty Limited as the Independent Expert;
- AMC Consultants Pty Ltd as the Independent Technical Expert; and
- Ernst & Young Strategy and Transactions Limited in respect of its Independent Limited Assurance Report as the Investigating Accountant.

Each of those persons named above has consented to the inclusion of each statement or report it has made or prepared in the form and context in which the statements or reports appear and has not withdrawn that consent at the date of this Scheme Booklet.

The following persons have given and have not, before the time of registration of this Scheme Booklet with ASIC, withdrawn their consent to be named in this Scheme Booklet in the form and context in which they are named:

- J.P. Morgan Securities Australia Limited and Gresham Advisory Partners Limited as financial advisers to Newcrest;
- Herbert Smith Freehills as legal adviser to Newcrest;
- Ernst & Young as auditor of Newcrest;
- Ernst & Young LLP as Independent Registered Public Accounting Firm for Newmont;
- Ernst & Young Strategy and Transactions Limited as Investigating Accountant; and
- Link Market Services Limited, TSX Trust Company and PNG Registries Limited each as a Newcrest Share Registry.

b) Disclosures and responsibility

Each person named in section 11.10(a):

- has not authorised or caused the issue of this Scheme Booklet;
- does not make, or purport to make, any statement or report in this Scheme Booklet or any statement on which a statement in this Scheme Booklet is based, other than:
 - > Newmont in respect of the Newmont Information only;
 - > Grant Samuel & Associates Pty Limited in relation to its Independent Expert's Report;
 - > AMC Consultants Pty Ltd in relation to its Independent Technical Expert's report (which is included in the Independent Expert's Report); and
 - > Ernst & Young Strategy and Transactions Limited in relation to its Independent Limited Assurance Report; and
- to the maximum extent permitted by law, expressly disclaims all liability in respect of, makes no representation regarding, and takes no responsibility for, any part of this Scheme Booklet other than a reference to its name and the statement or report (if any) included in this Scheme Booklet with the consent of that party as specified in this section 11.10(b).

11. Additional information

11.11 ASIC relief

a) Paragraph 8302(h) of Part 3 of Schedule 8 of the Corporations Regulations

Paragraph 8302(h) of Part 3 of Schedule 8 of the Corporations Regulations requires this Scheme Booklet to set out whether, within the knowledge of the Newcrest Directors, the financial position of Newcrest has materially changed since the date of the last balance sheet laid before Newcrest in general meeting (being its financial statements for the year ended 30 June 2022) or sent to Newcrest shareholders in accordance with section 314 or 317 of the Corporations Act and, if so, full particulars of any change. ASIC has granted Newcrest relief from this requirement so that this Scheme Booklet only needs to set out whether, within the knowledge of the Newcrest Directors, the financial position of Newcrest has materially changed since 30 June 2023 and, if so, full particulars of any change. Newcrest Shareholders can access a copy of Newcrest's financial statements for the year ended 30 June 2023 from the ASX (www.asx.com.au), PNGX (www.pngx.com.pg) and TSX (via SEDAR) (www.sedar.com) and Newcrest's website (www.newcrest.com).

b) Section 250N of the Corporations Act

Sections 250N and 315 of the Corporations Act requires Newcrest to hold its annual general meeting for FY23 and dispatch its annual report for FY23 by no later than 30 November 2023. In view of the Scheme, Newcrest has applied to ASIC under the Corporations Act to extend the period within which it would otherwise be required to hold the annual general meeting to 29 February 2024 and to extend the period for dispatch of the annual report until 21 days before the annual general meeting or 31 January 2024, whichever is earlier. ASIC has advised Newcrest that it has made a decision in principle to grant these extensions. Newcrest will announce to the ASX, PNGX and TSX (via SEDAR) when the extensions are granted.

11.12 Information in relation to Newmont's resources and reserves reporting

Newmont prepares its resources and reserves estimates in accordance with Subpart 1300, which is different to the reporting standard ordinarily applicable to ASX listed entities (i.e. the JORC Code).

a) Cautionary statement

Newmont's disclosures of Foreign Estimates are not reported in accordance with the JORC Code. The technical information contained in this Scheme Booklet relating to Newmont's mining projects has been prepared in accordance with the requirements of Subpart 1300.

A competent person has not done sufficient work to classify the Foreign Estimates as Mineral Resources or Ore Reserves in accordance with the JORC Code. It is uncertain that following evaluation and/or further exploration work that the Foreign Estimates would be able to be reported as Mineral Resources or Ore Reserves in accordance with the JORC Code.

If the Scheme is implemented, Newcrest will apply to be delisted from the Official List of the ASX and Newmont intends to apply for admission to the Official List of the ASX as a Foreign Exempt Listing. If admitted as a Foreign Exempt Listing, Newmont will be exempt from complying with ASX Listing Rule 5.12 and will instead continue to comply with Subpart 1300 in respect of resources and reserves reporting. As such, Newmont has no intention to present the foreign estimates in accordance with the JORC Code or otherwise to verify them for this purpose.

A comparison of the differences in resource categorisation under the JORC Code and Subpart 1300 is set out in section 11.12(b).

See section 11.13(b) for more information.



11.12 Information in relation to Newmont's resources and reserves reporting *continued*

b) Comparison of key terms used in JORC Code and Subpart 1300

The below table reflects excerpts of relevant key terms from the JORC Code and Subpart 1300.

Key term	JORC Code ⁶¹	Subpart 1300 ⁶²
Mineral resources		
Definition of 'Mineral Resource'	<p>A concentration or occurrence of solid material of economic interest in or on the Earth's crust in such form, grade (or quality), and quantity that there are reasonable prospects for eventual economic extraction (clause 20).</p> <p>The location, quantity, grade (or quality), continuity and other geological characteristics of a Mineral Resource are known, estimated or interpreted from specific geological evidence and knowledge, including sampling (clause 20).</p> <p>Mineral Resources are sub-divided, in order of increasing geological confidence, into Inferred, Indicated and Measured categories (clause 20).</p>	<p>A concentration or occurrence of material of economic interest in or on the earth's crust in such form, grade or quality, and quantity that there are reasonable prospects for economic extraction (s 229.1300).</p> <p>A mineral resource is a reasonable estimate of mineralisation, taking into account relevant factors such as cut-off grade, likely mining dimensions, location or continuity, that, with the assumed and justifiable technical and economic conditions, is likely to, in whole or in part, become economically extractable. It is not merely an inventory of all mineralisation drilled or sampled (s 229.1300).</p>
Definition of 'Inferred Mineral Resource'	<p>That part of a Mineral Resource for which quantity and grade (or quality) are estimated on the basis of limited geological evidence and sampling. Geological evidence is sufficient to imply but not verify geological and grade (or quality) continuity. It is based on exploration, sampling and testing information gathered through appropriate techniques from locations such as outcrops, trenches, pits, workings and drill holes (clause 21).</p> <p>An Inferred Mineral Resource has a lower level of confidence than that applying to an Indicated Mineral Resource and must not be converted to an Ore Reserve. It is reasonably expected that the majority of Inferred Mineral Resources could be upgraded to Indicated Mineral Resources with continued exploration (clause 21).</p>	<p>That part of a mineral resource for which quantity and grade or quality are estimated on the basis of limited geological evidence and sampling. The level of geological uncertainty associated with an inferred mineral resource is too high to apply relevant technical and economic factors likely to influence the prospects of economic extraction in a manner useful for evaluation of economic viability.</p> <p>Because an inferred mineral resource has the lowest level of geological confidence of all mineral resources, which prevents the application of the modifying factors in a manner useful for evaluation of economic viability, an inferred mineral resource may not be considered when assessing the economic viability of a mining project, and may not be converted to a mineral reserve (s 229.1300).</p>
Definition of 'Indicated Mineral Resource'	<p>That part of a Mineral Resource for which quantity, grade (or quality), densities, shape and physical characteristics are estimated with sufficient confidence to allow the application of Modifying Factors in sufficient detail to support mine planning and evaluation of the economic viability of the deposit (clause 22).</p> <p>Geological evidence is derived from adequately detailed and reliable exploration, sampling and testing gathered through appropriate techniques from locations such as outcrops, trenches, pits, workings and drill holes, and is sufficient to assume geological and grade (or quality) continuity between points of observation where data and samples are gathered (clause 22).</p> <p>An Indicated Mineral Resource has a lower level of confidence than that applying to a Measured Mineral Resource and may only be converted to a Probable Ore Reserve (clause 22).</p>	<p>That part of a mineral resource for which quantity and grade or quality are estimated on the basis of adequate geological evidence and sampling. The level of geological certainty associated with an indicated mineral resource is sufficient to allow a qualified person to apply modifying factors in sufficient detail to support mine planning and evaluation of the economic viability of the deposit. Because an indicated mineral resource has a lower level of confidence than the level of confidence of a measured mineral resource, an indicated mineral resource may only be converted to a probable mineral reserve (s 229.1300).</p>

61. All references to a clause in this column are references to the JORC Code.

62. All references to a section or item in this column are references to Subpart 229.1300 of the Securities Act of 1993 (US), Regulation S-K.

11. Additional information

11.12 Information in relation to Newmont's resources and reserves reporting *continued*

Key term	JORC Code	Subpart 1300
Definition of 'Measured Mineral Resource'	<p>That part of a Mineral Resource for which quantity, grade (or quality), densities, shape, and physical characteristics are estimated with confidence sufficient to allow the application of Modifying Factors to support detailed mine planning and final evaluation of the economic viability of the deposit (clause 23).</p> <p>Geological evidence is derived from detailed and reliable exploration, sampling and testing gathered through appropriate techniques from locations such as outcrops, trenches, pits, workings and drill holes, and is sufficient to confirm geological and grade (or quality) continuity between points of observation where data and samples are gathered (clause 23).</p> <p>A Measured Mineral Resource has a higher level of confidence than that applying to either an Indicated Mineral Resource or an Inferred Mineral Resource. It may be converted to a Proved Ore Reserve or under certain circumstances to a Probable Ore Reserve (clause 23).</p>	<p>That part of a mineral resource for which quantity and grade or quality are estimated on the basis of conclusive geological evidence and sampling. The level of geological certainty associated with a measured mineral resource is sufficient to allow a qualified person to apply modifying factors, as defined in this section, in sufficient detail to support detailed mine planning and final evaluation of the economic viability of the deposit. Because a measured mineral resource has a higher level of confidence than the level of confidence of either an indicated mineral resource or an inferred mineral resource, a measured mineral resource may be converted to a proven mineral reserve or to a probable mineral reserve (s 229.1300).</p>
<p>Ore Reserves Note: References to an 'Ore Reserve' should be read as a reference to a 'Mineral reserve' (as the concept is defined under Subpart 1300)</p>		
Definition of 'Ore Reserve' (or 'Mineral reserve', under Subpart 1300)	<p>An 'Ore Reserve' is the economically mineable part of a Measured and/or Indicated Mineral Resource. It includes diluting materials and allowances for losses, which may occur when the material is mined or extracted and is defined by studies at Pre-Feasibility or Feasibility level as appropriate that include application of Modifying Factors. Such studies demonstrate that, at the time of reporting, extraction could reasonably be justified (clause 29).</p> <p>The reference point at which Reserves are defined, usually the point where the ore is delivered to the processing plant, must be stated. It is important that, in all situations where the reference point is different, such as for a saleable product, a clarifying statement is included to ensure that the reader is fully informed as to what is being reported (clause 29).</p>	<p>An estimate of tonnage and grade or quality of indicated and measured mineral resources that, in the opinion of the qualified person, can be the basis of an economically viable project. More specifically, it is the economically mineable part of a measured or indicated mineral resource, which includes diluting materials and allowances for losses that may occur when the material is mined or extracted (s 229.1300).</p>
Definition of a 'Probable Ore Reserve'	<p>The economically mineable part of an Indicated, and in some circumstances, a Measured Mineral Resource. The confidence in the Modifying Factors applying to a Probable Ore Reserve is lower than that applying to a Proved Ore Reserve (clause 30).</p>	<p>The economically mineable part of an indicated and, in some cases, a measured mineral resource (s 229.1300).</p>
Definition of a 'Proved Ore Reserve'	<p>The economically mineable part of a Measured Mineral Resource. A Proved Ore Reserve implies a high degree of confidence in the Modifying Factors (clause 31).</p>	<p>The economically mineable part of a measured mineral resource and can only result from conversion of a measured mineral resource (s 229.1300).</p>



11.12 Information in relation to Newmont's resources and reserves reporting *continued*

Key term	JORC Code	Subpart 1300
Other definitions / concepts		
Competent person / qualified person	<p>A 'Competent Person' is a minerals industry professional who is a Member or Fellow of The Australasian Institute of Mining and Metallurgy, or of the Australian Institute of Geoscientists, or of a 'Recognised Professional Organisation' (RPO), as included in a list available on the JORC and ASX websites. These organisations have enforceable disciplinary processes including the powers to suspend or expel a member.</p> <p>A Competent Person must have a minimum of five years relevant experience in the style of mineralisation or type of deposit under consideration and in the activity which that person is undertaking.</p> <p>If the Competent Person is preparing documentation on Exploration Results, the relevant experience must be in exploration.</p> <p>If the Competent Person is estimating, or supervising the estimation of Mineral Resources, the relevant experience must be in the estimation, assessment and evaluation of Mineral Resources.</p> <p>If the Competent Person is estimating, or supervising the estimation of Ore Reserves, the relevant experience must be in the estimation, assessment, evaluation and economic extraction of Ore Reserves.</p>	<p>A 'qualified person' is an individual who is:</p> <ol style="list-style-type: none"> 1) a mineral industry professional with at least five years of relevant experience in the type of mineralisation and type of deposit under consideration and in the specific type of activity that person is undertaking on behalf of the registrant; and 2) an eligible member or licensee in good standing of a recognised professional organisation at the time the technical report is prepared. <p>For an organisation to be a recognised professional organisation, it must:</p> <ol style="list-style-type: none"> i) be either: <ol style="list-style-type: none"> A) an organisation recognised within the mining industry as a reputable professional association; or B) a board authorised by United States federal, state or foreign statute to regulate professionals in the mining, geoscience or related field; ii) admit eligible members primarily on the basis of their academic qualifications and experience; iii) establish and require compliance with professional standards of competence and ethics; iv) require or encourage continuing professional development; v) have and apply disciplinary powers, including the power to suspend or expel a member regardless of where the member practices or resides; and vi) provide a public list of members in good standing. <p>Relevant experience means, for purposes of determining whether a party is a qualified person, that the party has experience in the specific type of activity that the person is undertaking on behalf of the registrant. If the qualified person is preparing or supervising the preparation of a technical report concerning exploration results, the relevant experience must be in exploration. If the qualified person is estimating, or supervising the estimation of mineral resources, the relevant experience must be in the estimation, assessment and evaluation of mineral resources and associated technical and economic factors likely to influence the prospect of economic extraction. If the qualified person is estimating, or supervising the estimation of mineral reserves, the relevant experience must be in engineering and other disciplines required for the estimation, assessment, evaluation and economic extraction of mineral reserves.</p> <ol style="list-style-type: none"> 1) Relevant experience also means, for purposes of determining whether a party is a qualified person, that the party has experience evaluating the specific type of mineral deposit under consideration (e.g. coal, metal, base metal, industrial mineral, or mineral brine). The type of experience necessary to qualify as relevant is a facts and circumstances determination. For example, experience in a high-nugget, vein-type mineralisation such as tin or tungsten would likely be relevant experience for estimating mineral resources for vein-gold mineralisation, whereas experience in a low grade disseminated gold deposit likely would not be relevant.⁶³ 2) For a qualified person providing a technical report for exploration results or mineral resource estimates, relevant experience also requires, in addition to experience in the type of mineralisation, sufficient experience with the sampling and analytical techniques, as well as extraction and processing techniques, relevant to the mineral deposit under consideration. Sufficient experience means that level of experience necessary to be able to identify, with substantial confidence, problems that could affect the reliability of data and issues associated with processing. 3) For a qualified person applying the modifying factors, as defined by this section, to convert mineral resources to mineral reserves, relevant experience also requires: <ol style="list-style-type: none"> i) sufficient knowledge and experience in the application of these factors to the mineral deposit under consideration; and ii) experience with the geology, geostatistics, mining, extraction and processing that is applicable to the type of mineral and mining under consideration.

63. It is not always necessary for a person to have five years' experience in each and every type of deposit in order to be an eligible qualified person if that person has relevant experience in similar deposit types. For example, a person with 20 years' experience in estimating mineral resources for a variety of metalliferous hard-rock deposit types may not require as much as five years of specific experience in porphyry-copper deposits to act as a qualified person. Relevant experience in the other deposit types could count towards the experience in relation to porphyry-copper deposits.

11. Additional information

11.13 Compliance Statements

a) Newcrest

The information in this Scheme Booklet that relates to Mineral Resources, Ore Reserves and related scientific and technical information has been extracted from the release titled "Annual Mineral Resources and Ore Reserves Statement – as at 30 June 2023" dated 11 August 2023 (**original MR&OR release**). The original MR&OR release is available to view at www.asx.com.au under the code "NCM" and on TSX (via SEDAR). Newcrest confirms that it is not aware of any new information or data that materially affects the information included in the original exploration releases and the original MR&OR release (the original releases) and that all material assumptions and technical parameters underpinning the estimates in the original releases continue to apply and have not materially changed. Newcrest confirms that the form and context in which the competent person's findings are presented have not been materially modified from the original releases.

The information in this Scheme Booklet that relates to the Mineral Resources, Ore Reserves, and associated scientific and technical information, is based on and fairly represents information compiled by Ms J Terry. Ms Terry is Newcrest's Head of Mineral Resource Management and a full-time employee of Newcrest Mining Limited. She is a Fellow of the Australasian Institute of Mining and Metallurgy. Ms Terry has sufficient experience which is relevant to the styles of mineralisation and types of deposits under consideration and to the activity which she is undertaking to qualify as a Competent Person as defined in the JORC Code and as a Qualified Person under NI 43-101. Ms Terry has reviewed and approves the disclosure of scientific and technical information contained in this document and consents to the inclusion in this Scheme Booklet of the matters based on her information in the form and context in which it appears.

b) Newmont

Mr Donald Doe, a Qualified Person under Subpart 1300, has approved the information in sections 6 and 7.

Information in this Scheme Booklet that relates to Newmont's:

- proven and probable reserves; and
- measured, indicated and inferred resources,

is based on information compiled by Mr Donald Doe. Mr Doe is employed full-time by Newmont as Group Executive, Reserves and is a registered member of the Society for Mining, Metallurgy and Exploration. Mr Doe has 35 years of experience that is relevant to the styles of mineralisation and the types of deposit under consideration. Mr Doe is a "qualified person" for the purposes of Subpart 1300.

11.14 No unacceptable circumstances

The Newcrest Directors believe that the Scheme does not involve any circumstances in relation to the affairs of Newcrest that could reasonably be characterised as constituting 'unacceptable circumstances' for the purposes of section 657A of the Corporations Act.

11.15 No other material information

Except as disclosed elsewhere in this Scheme Booklet, so far as the Newcrest Directors are aware, there is no other information that is:

- material to the making of a decision by a Newcrest Shareholder whether or not to vote in favour of the Scheme; and
- known to any Newcrest Director at the date of lodging this Scheme Booklet with ASIC for registration,

which has not previously been disclosed to Newcrest Shareholders.

11.16 Supplementary disclosure

Newcrest will issue a supplementary document to this Scheme Booklet if, between the date of this Scheme Booklet and the Second Court Date, it becomes aware of any new or further information that is:

- material to a decision of Newcrest Shareholders in deciding how to vote on the Scheme or whether to attend the Scheme Meeting; or
- necessary to ensure that information contained in this Scheme Booklet is not false, misleading or deceptive (including by way of omission) in any material respect.

If Newcrest is required to issue a supplementary document to this Scheme Booklet between the date of this Scheme Booklet and the Second Court Date, depending on the nature and timing of the changed circumstances, and subject to obtaining any relevant approvals, Newcrest may circulate and publish any supplementary document by:

- making an announcement to the ASX, PNGX and TSX (via SEDAR);
- placing an advertisement in a prominently published newspaper which is circulated generally throughout Australia;
- sending the supplementary document to Newcrest Shareholders at their address shown on the Newcrest Share Register; and/or
- posting a statement on Newcrest's website at www.newcrest.com,

as Newcrest, in its absolute discretion, considers appropriate.

In this Scheme Booklet, unless the context otherwise appears, the following terms have the meanings shown below:

Term	Meaning
ADS	American Depositary Share
Ag	silver
AISC	all-in sustaining costs
ASIC	the Australian Securities and Investments Commission
Associate	has the meaning set out in section 12 of the Corporations Act subject to section 16 of the Corporations Act
ASX	ASX Limited ABN 98 008 624 691 and, where the context requires, the financial market that it operates
ASX Listing Rules	the official listing rules of the ASX
ASX Quotation	the admission of Newmont to the official list of the ASX as an ASX Foreign Exempt Listing and the official quotation of all Newmont CDIs on the ASX
ASX Settlement Rules	the ASX Settlement Operating Rules, being the official operating rules of the settlement facility provided by ASX Settlement Pty Ltd
ATO	the Australian Taxation Office
Au	gold
Australian Register	that part of the register of members of Newcrest maintained in Australia on behalf of Newcrest by Link Market Services Limited
Brucejack	the underground mining operation located in British Columbia that is fully owned by Newcrest
Business Day	a day that is not a Saturday, Sunday or a public holiday or bank holiday in Melbourne, Australia or Denver, Colorado, United States
Cadia	the mining operation located in central western NSW that is fully owned by Newcrest
Canadian Competition Act	the Competition Act (Canada) and the regulations promulgated thereunder
Canadian Competition Bureau	the Canadian Competition Bureau established as an independent enforcement agency of the Government of Canada that is headed by the Canadian Competition Commissioner
Canadian Competition Commissioner	the Commissioner of Competition appointed under subsection 7(1) of the Canadian Competition Act and includes any person designated by the Canadian Commissioner to act on his behalf
Canadian Register	that part of the register of members of Newcrest maintained in Canada on behalf of Newcrest by TSX Trust Company
CC&V	the Cripple Creek & Victor gold mine, located next to the town of Victor and the city of Cripple Creek, Colorado, USA.
CDI	a CHESS Depositary Interest, being a unit of beneficial interests in securities of a foreign registered company, registered in the name of CDN, or held in the form of beneficial ownership
CDN	CHESS Depositary Nominees Pty Limited ACN 071 346 506
CHESS	the Clearing House Electronic Subregister System operated by ASX Settlement and Transfer Corporation Pty Ltd and ASX Clear Pty Limited
Class Ruling	a binding public ruling issued by the Commissioner of Taxation pursuant to Division 358 of Schedule 1 of the <i>Tax Administration Act 1953</i> (Cth) and as described in the class ruling CR 2001/1
Code	the Internal Revenue Code of 1986, as amended from time to time
Competing Proposal	a Newcrest Competing Proposal or a Newmont Competing Proposal, as applicable
Competition Approvals	the approvals from the competition regulators in the following jurisdictions that are necessary to implement the Scheme: <ol style="list-style-type: none"> 1. Japan; 2. South Korea; and 3. the Philippines.
Condition Precedent	each of the conditions in clause 3.1 of the Scheme Implementation Deed
Corporations Act	the <i>Corporations Act 2001</i> (Cth), as modified or varied by ASIC
Corporations Regulations	the <i>Corporations Regulations 2001</i> (Cth)
Court	the Federal Court of Australia or such other court of competent jurisdiction under the Corporations Act agreed to in writing by Newcrest and Newmont

12. Definitions

Term	Meaning
Cu	copper
Deed Poll	a deed poll in the form of Annexure 4 under which Newmont and Newmont Overseas covenants in favour of the Scheme Shareholders to perform the respective obligations attributed to Newmont and Newmont Overseas under the Scheme
Deposit Agreement	the deposit agreement dated 23 August 2010 between Newcrest, the Depositary and Newcrest ADS Holders
Depositary	The Bank of New York Mellon
DGCL	the Delaware General Corporation Law
DRS	means the Direct Registration System, which allows registered securities to be held in electronic book-entry form without having a physical security certificate issued as evidence of ownership
Effective	when used in relation to the Scheme, the coming into effect, under subsection 411(10) of the Corporations Act, of the order of the Court made under subparagraph 411(4)(b) of the Corporations Act in relation to the Scheme
Effective Date	the date on which the Scheme becomes Effective, currently expected to be Wednesday, 18 October 2023
End Date	15 February 2024
Exchange Act	the United States Securities Exchange Act of 1934, as amended, and the rules and regulations thereunder
Fairly Disclosed	has the meaning given in the Scheme Implementation Deed
FATA	the <i>Foreign Acquisitions and Takeovers Act 1975</i> (Cth)
FIRB	the Australian Foreign Investment Review Board
First Court Date	the first day on which an application made to the Court for an order under subsection 411(1) of the Corporations Act convening the Scheme Meeting is heard
Foreign Estimate	a foreign resource estimate presented in accordance with ASX Listing Rule 5.12
Foreign Exempt Listing	the admission of an entity to the official list of the ASX as an ASX Foreign Exempt Listing pursuant to ASX Listing Rule 1.11
FY21	the 12 months ended 30 June 2021
FY22	the 12 months ended 30 June 2022
FY23	the 12 months ended 30 June 2023
FY24	the 12 months ending 30 June 2024
Government Agency	any foreign or Australian government or governmental, semigovernmental, administrative, fiscal, taxing, monetary or judicial body, department, commission, authority, tribunal, agency or entity, or any minister of any federal, state, provincial, or local government, whether foreign or Australian, and includes the ASX, NYSE, TSX, PNGX and any other relevant stock exchange, ASIC, the Takeovers Panel, FIRB, the ATO, the Canadian Competition Bureau, the ICCC, the United States Department of Justice, the SEC, the Ontario Securities Commission, and any state or territory revenue offices
GST	has the meaning given in the GST Act
GST Act	the <i>A New Tax System (Goods and Services Tax) Act 1999</i> (Cth)
g/t	grams per tonne
Havieron	the exploration project located in the Paterson Province in Western Australia that is 70% owned by Newcrest
Headwater	Headwater Gold Inc
HSR Act	the United States Hart-Scott-Rodino Antitrust Improvements Act of 1976, as amended, and the rules and regulations promulgated thereunder
HMRC	His Majesty's Revenue & Customs
ICCC	the Independent Consumer and Competition Commission of PNG
Implementation Date	the fifth Business Day after the Scheme Record Date, or such other date after the Scheme Record Date as Newcrest and Newmont agree in writing, currently expected to be Monday, 6 November 2023
Independent Expert	Grant Samuel & Associates Pty Limited, the independent expert in respect of the Scheme appointed by Newcrest
Independent Expert's Report	the report issued by the Independent Expert in connection with the Scheme, as set out in Annexure 1

Term	Meaning
Independent Limited Assurance Report	the report prepared by the Investigating Accountant as set out in Annexure 2
Independent Technical Expert	AMC Consultants Pty Ltd
Indicated Mineral Resource	has the meaning given to that term in the JORC Code
Ineligible Foreign Shareholder	a Scheme Shareholder whose address shown in the Newcrest Share Register on the Scheme Record Date is a place outside Australia and its external territories, Canada, New Zealand, PNG, the United Kingdom, the United States, the European Union (excluding Austria), Guernsey, Hong Kong, Japan, Norway, Singapore, South Korea, Switzerland, the United Arab Emirates, the Isle of Man and Bermuda.
Inferred Mineral Resource	has the meaning given to that term in the JORC Code
Insolvency Event	<p>in relation to an entity:</p> <ol style="list-style-type: none"> 1. the entity resolving that it be wound up or a court making an order for the winding up or dissolution of the entity; 2. a Controller (as defined in the Corporations Act), liquidator, provisional liquidator, administrator, receiver and manager or other insolvency official being appointed to the entity or in relation to the whole, or a substantial part, of its assets; 3. an application is made to a court, a meeting is convened or a resolution is passed for the entity to be wound up or dissolved or for the appointment of a Controller (as defined in the Corporations Act), liquidator, provisional liquidator or administrator to the entity of any of its assets; 4. the entity seeks or obtains protection from its creditors under any statute or any other law; 5. the entity executing a deed of company arrangement; 6. the entity ceases, or threatens to cease, to carry on substantially all the business conducted by it as at 15 May 2023; 7. the entity is or becomes unable to pay its debts when they fall due, is insolvent within the meaning of the Corporations Act (or applicable legislation of its place of incorporation) or is otherwise presumed to be insolvent under the Corporations Act (or applicable legislation of its place of incorporation) or any analogous circumstances arises under any other statute or law; 8. the entity being deregistered as a company or otherwise dissolved (whether pursuant to Chapter 5A of the Corporations Act or otherwise), <p>or any other like event, matter or circumstance occurring in relation to an entity in another jurisdiction.</p>
Investigating Accountant	Ernst & Young Strategy and Transactions Limited, the investigating accountant in respect of the Scheme appointed by Newcrest and Newmont
JORC Code	the Australasian Code for Reporting of Exploration Results, Mineral Resources and Ore Reserves 2012, as updated from time to time
Koz	thousand ounces
kt	thousand tonnes
Last Practicable Date	3 September 2023, being the last practicable date to prepare information before finalising this Scheme Booklet for registration by ASIC
Lihir	the mining operation located in PNG that is fully owned by Newcrest
Lundin Gold	Lundin Gold Inc
Measured Mineral Resource	has the meaning given to that term in the JORC Code
Merged Group	the Newmont Group including the Newcrest Group following implementation of the Scheme
Merged Group Information	means any information regarding the Merged Group in this Scheme Booklet or Newmont Proxy Statement or any amendments or supplements of such disclosure (as applicable)

12. Definitions

Term	Meaning
Merged Group Pro Forma Historical Financial Information	has the meaning given in section 7.7
Mineral Resource	has the meaning given to that term in the JORC Code
Mo	molybdenum
Moz	million ounces
Mt	million tonnes
Net Cash Proceeds	the net cash proceeds of the sale of the Newmont Shares via the Sale Facility (after deduction of any reasonable brokerage or other selling costs, taxes and charges)
Newcrest	Newcrest Mining Limited ACN 005 683 625
Newcrest ADS	an American Depositary Share representing one Newcrest Share
Newcrest ADS Holder	a holder of a Newcrest ADS
Newcrest Board	the board of directors of Newcrest
Newcrest Competing Proposal	<p>any genuine proposal, offer, expression of interest, agreement, arrangement or transaction (or similar) which, if entered into or completed substantially in accordance with its terms, would result in:</p> <ol style="list-style-type: none"> a Third Party (either alone or together with one or more Associates) directly or indirectly in a single transaction or a series of related transactions: <ul style="list-style-type: none"> – acquiring a Relevant Interest in, or acquiring or having a right to acquire, a legal, beneficial or economic interest (including an economic interest by way of one or more derivative contracts, an economic swap, contract for difference or similar transaction or arrangement) in, or control of, 20% or more of the Newcrest Shares; – acquiring Control (as defined in the Corporations Act) of Newcrest or of any member of the Newcrest Group which holds all, or substantially all, of the property or material assets of the Newcrest Group; – acquiring, acquiring an interest in, becoming the holder of, or otherwise acquiring or having a right to acquire, a legal, beneficial or economic interest in, or control of, all or substantially all of the property or material assets of the Newcrest Group taken as a whole; – otherwise acquiring, amalgamating or merging with Newcrest; or – requiring Newcrest to abandon, or otherwise fail to proceed with, the Transaction, <p>in each case whether by way of takeover bid, members' or creditors' scheme of arrangement, reverse takeover, shareholder approved acquisition, capital reduction, buy-back, sale, lease or purchase of shares, other securities or assets, assignment of assets and liabilities, incorporated or unincorporated joint venture, dual-listed company (or other synthetic merger), deed of company arrangement, any debt for equity arrangement, reorganisation, recapitalisation, refinancing or other transaction or arrangement; or</p> any 'top-hatting' or redomiciliation of Newcrest, which would result in the Scheme not being able to be implemented substantially in accordance with the terms of the Scheme Implementation Deed and the Scheme. <p>Each successive material modification or variation of a Newcrest Competing Proposal will constitute a new Newcrest Competing Proposal.</p>
Newcrest Director	any director of Newcrest comprising part of the Newcrest Board
Newcrest Disclosure Materials	has the meaning given in the Scheme Implementation Deed
Newcrest Equity Incentives	any option, restricted share or right to Newcrest Shares issued under employee incentive arrangements of the Newcrest Group

Term	Meaning
Newcrest Group	Newcrest and each of its Related Bodies Corporate, and a reference to a ' Newcrest Group Member ' or a ' member of the Newcrest Group ' is to Newcrest or any of its Related Bodies Corporate
Newcrest Historical Financial Information	has the meaning given in section 5.8
Newcrest Information	<ol style="list-style-type: none"> 1 the entirety of the information included in this Scheme Booklet (or any amendment or supplement) other than the Newmont Information, the Independent Expert's Report (or references to the Independent Expert's analysis or conclusions), the Independent Limited Assurance Report or other report or opinion prepared by an external adviser to Newcrest; and 2 information relating to the Newcrest Group or the businesses of the Newcrest Group expressly provided by or on behalf of Newcrest to Newmont in writing for use in the preparation of the Merged Group Information in this Scheme Booklet or in the Newmont Proxy Statement, as applicable (or in any amendment or supplement).
Newcrest Material Adverse Change	<p>any event, occurrence, change, condition, matter, circumstance or thing (each a Specified Event) which, whether individually or when aggregated with all such Specified Events that have occurred, has had or would be considered reasonably likely to have the effect of the consolidated net assets of the Newcrest Group, taken as a whole (and net of all insurance proceeds), being reduced by an amount of at least \$2 billion, other than any event, occurrence, change, condition, matter, circumstance or thing:</p> <ol style="list-style-type: none"> 1. required or expressly permitted by the Scheme Implementation Deed or the Scheme; 2. Fairly Disclosed in the Newcrest Disclosure Materials; 3. Fairly Disclosed in: <ul style="list-style-type: none"> – Newcrest's announcements to the ASX, PNGX or SEDAR in the period from 4 October 2022 (inclusive) to 15 May 2023; or – any information publicly available on a Public Register on the corresponding search date, (excluding any risk factor disclosure and disclosure of risks in "forward looking statement" disclaimers that are predictive, forward-looking or primarily cautionary in nature); 4. agreed to in writing by Newmont (in its sole and absolute discretion); 5. resulting from any actual or announced change to any applicable law, any judicial or administrative interpretation of the law or any practice or policy of a Government Agency, including in relation to Tax; 6. arising as a result of any actual or announced change in any generally accepted accounting principles or standards or the interpretation of such principles or standards; 7. arising as a result of any changes in general economic, industry, regulatory or political conditions or the securities or other capital markets; 8. arising as a result of any geopolitical conditions, hostilities, civil or political unrest, any acts of war, sabotage, cyberattack or terrorism (including any outbreak, escalation or worsening of any of the foregoing); 9. arising from any epidemic, pandemic, lightning, storm, flood, fire, seismic event or explosion, cyclone, tidal wave, landslide, natural disaster or adverse weather conditions or the like; 10. arising as a result of the execution, announcement or performance of the Scheme Implementation Deed or the Scheme in accordance with its terms; or 11. arising as a result of any change or fluctuation in taxation rate, interest rates, commodity prices or exchange rates, <p>except, in the case of each of the matters contemplated in items 5, 6, 8, 9 and 11, if the effects of such event, occurrence, change, condition, matter, circumstance or thing are, or would be considered reasonably likely to be, disproportionately adverse to the Newcrest Group as compared to the effects on other comparable companies in the same industries as the Newcrest Group, then those effects are excluded from the matters contemplated in items 5, 6, 8, 9 or 11 (as applicable) only to the extent of such disproportionate effect and not in their entirety.</p> <p>For the purposes of this definition, consolidated net assets will be calculated using the same principles as were used to calculate the consolidated net assets in Newcrest's audited financial statements for the year ended 30 June 2022.</p>

12. Definitions

Term	Meaning
Newcrest Prescribed Occurrence	<p>other than:</p> <ol style="list-style-type: none"> 1. as required or expressly permitted by the Scheme Implementation Deed or the Scheme; 2. as Fairly Disclosed in the Newcrest Disclosure Materials; 3. with the consent of Newmont (in its sole and absolute discretion); 4. in connection with the Newcrest Special Dividend or an Ordinary Course Dividend (including any arrangements to fund such dividends); 5. in connection with Newcrest conducting intra-group funding arrangements; 6. as required by law or reasonably required by any Government Agency; or 7. as Fairly Disclosed by Newcrest in an announcement made by it to the ASX, PNGX or SEDAR in the period from 4 October 2022 (inclusive) to 15 May 2023 (excluding any risk factor disclosure and disclosure of risks in "forward looking statement" disclaimers that are predictive, forward-looking or primarily cautionary in nature), the occurrence of any of the following after 15 May 2023: <ol style="list-style-type: none"> 8. Newcrest converting all or any of its shares into a larger or smaller number of shares; 9. Newcrest or another member of the Newcrest Group resolving to reduce its share capital in any way or resolving to reclassify, combine, split or redeem or repurchase directly or indirectly any of its shares; 10. Newcrest or another member of the Newcrest Group entering into a buy-back agreement or resolving to approve the terms of a buy-back agreement under the Corporations Act; 11. a member of the Newcrest Group issuing shares or securities convertible into shares, or granting, vesting or accelerating a performance right or an option over its shares, or agreeing to make such an issue or grant, vest or accelerate such a share, convertible security, performance right or an option, other than: <ul style="list-style-type: none"> – on vesting or exercise of, or in respect of, a Newcrest Equity Incentive, or the granting of new Newcrest Equity Incentives to a Newcrest director, officer or employee under a Newcrest equity incentive or employee share plan in place at 15 May 2023, in each case only to the extent permitted by the Scheme Implementation Deed; – in connection with the dividend reinvestment plan; or – to another wholly-owned Newcrest Group Member; or 12. a Newcrest Group Member adopting, modifying or repealing its constitution or a provision of it; 13. a Newcrest Group Member granting a Security Interest, or agreeing to grant a Security Interest, in the whole, or a substantial part, of its business or property; or 14. an Insolvency Event occurs in relation to a material Newcrest Group Member.
Newcrest Share	a fully paid ordinary share in the capital of Newcrest
Newcrest Share Register	<p>the register of members of Newcrest maintained in accordance with the Corporations Act and comprising the:</p> <ol style="list-style-type: none"> 1. Australian Register; 2. Canadian Register; and 3. PNG Register.
Newcrest Share Registry	<p>each of:</p> <ol style="list-style-type: none"> 1. Link Market Services Limited; 2. TSX Trust Company; and 3. PNG Registries Limited.
Newcrest Shareholder	a person who is registered as the holder of a Newcrest Share in the Newcrest Share Register
Newmont	Newmont Corporation
Newmont Board	the board of directors of Newmont
Newmont CDI	a CHES Depositary Interest, being a unit of beneficial ownership in a Newmont Share (in the form of a CHES Depositary Interest) registered in the name of CDN, or held in the form of beneficial ownership, to be issued to Scheme Shareholders under the Scheme

Term	Meaning																				
Newmont Competing Proposal	<p>any genuine proposal, offer, expression of interest, agreement, arrangement or transaction (or similar) which, if entered into or completed substantially in accordance with its terms, would result in:</p> <ol style="list-style-type: none"> a Third Party (either alone or together one or more Associates) directly or indirectly in a single transaction or a series of related transactions: <ul style="list-style-type: none"> – acquiring an interest in, or acquiring or having a right to acquire, a legal, beneficial or economic interest in (including an economic interest by way of one or more derivative contracts, an economic swap, contract for difference or similar transaction or arrangement), or control of, 20% or more of the Newmont Shares; – acquiring, acquiring an interest in, becoming the holder of, or otherwise acquiring or having a right to acquire, a legal, beneficial or economic interest in, or control of, all or substantially all of the property or material assets of the Newmont Group taken as a whole; – otherwise acquiring, amalgamating or merging with Newmont; or – requiring Newmont to abandon, or otherwise fail to proceed with, the Transaction, <p>in each case whether by way of takeover bid, members' or creditors' scheme of arrangement, reverse takeover, shareholder approved acquisition, capital reduction, buy-back, sale, lease or purchase of shares, other securities or assets, assignment of assets and liabilities, incorporated or unincorporated joint venture, dual-listed company (or other synthetic merger), deed of company arrangement, any debt for equity arrangement, reorganisation, recapitalisation, refinancing or other transaction or arrangement; or</p> any 'top-hatting' or redomiciliation of Newmont, which would result in the Scheme not being able to be implemented substantially in accordance with the terms of the Scheme Implementation Deed and the Scheme. <p>Each successive material modification or variation of a Newmont Competing Proposal will constitute a new Newmont Competing Proposal.</p>																				
Newmont Disclosure Materials	has the meaning given in the Scheme Implementation Deed																				
Newmont Equity Incentives	has the meaning given in section 6.17																				
Newmont FY22 Annual Report	Newmont's Annual Report on Form 10-K for the year ended 31 December 2022, filed with the SEC on 23 February 2023, as updated by Newmont's Current Report on Form 8-K, filed with the SEC on 20 July 2023																				
Newmont Group	Newmont and each of its Related Bodies Corporate, and a reference to a ' Newmont Group Member ' or a ' member of the Newmont Group ' is to Newmont or any of its Related Bodies Corporate																				
Newmont Historical Financial Information	has the meaning given in section 6.15																				
Newmont Information	<p>information about the Newmont Group, the Merged Group, the businesses of the Newmont Group and Merged Group, Newmont Securities, Newmont's interests and dealings in Newcrest Shares and Newmont's intentions for the Merged Group and the Merged Group's employees and Newmont's funding expressly provided by or on behalf of Newmont to Newcrest in writing for inclusion in this Scheme Booklet (or any amendment or supplement), including the information in the following sections or parts of those sections:</p> <table border="0"> <tr> <td>1 Letter from the CEO of Newmont;</td> <td>8 Sections 8.2;</td> </tr> <tr> <td>2 Important notices:</td> <td>9 Sections 8.3;</td> </tr> <tr> <td>– the second paragraph under the heading 'Responsibility statement';</td> <td>10 Section 10 to the extent it relates to Newmont;</td> </tr> <tr> <td>– 'Notice to United States investors'; and</td> <td>11 Section 11.5;</td> </tr> <tr> <td>– 'Notice to PNG investors';</td> <td>12 Section 11.6;</td> </tr> <tr> <td>3 Section 4.2(b);</td> <td>13 Section 11.8;</td> </tr> <tr> <td>4 Section 4.3;</td> <td>14 Section 11.9;</td> </tr> <tr> <td>5 Section 4.5;</td> <td>15 Section 11.12; and</td> </tr> <tr> <td>6 Section 6;</td> <td>16 Section 11.13(b),</td> </tr> <tr> <td>7 Section 7 as it relates to Newmont's contribution to the information regarding the Merged Group (it being noted that, to avoid doubt, Newcrest is responsible for all information in section 7 relating to the Newcrest Group or the businesses of the Newcrest Group expressly provided by or on behalf of Newcrest to Newmont in writing for use in the preparation of the Merged Group Information in that section);</td> <td>in each case, excluding any Newcrest Information.</td> </tr> </table>	1 Letter from the CEO of Newmont;	8 Sections 8.2;	2 Important notices:	9 Sections 8.3;	– the second paragraph under the heading 'Responsibility statement';	10 Section 10 to the extent it relates to Newmont;	– 'Notice to United States investors'; and	11 Section 11.5;	– 'Notice to PNG investors';	12 Section 11.6;	3 Section 4.2(b);	13 Section 11.8;	4 Section 4.3;	14 Section 11.9;	5 Section 4.5;	15 Section 11.12; and	6 Section 6;	16 Section 11.13(b),	7 Section 7 as it relates to Newmont's contribution to the information regarding the Merged Group (it being noted that, to avoid doubt, Newcrest is responsible for all information in section 7 relating to the Newcrest Group or the businesses of the Newcrest Group expressly provided by or on behalf of Newcrest to Newmont in writing for use in the preparation of the Merged Group Information in that section);	in each case, excluding any Newcrest Information.
1 Letter from the CEO of Newmont;	8 Sections 8.2;																				
2 Important notices:	9 Sections 8.3;																				
– the second paragraph under the heading 'Responsibility statement';	10 Section 10 to the extent it relates to Newmont;																				
– 'Notice to United States investors'; and	11 Section 11.5;																				
– 'Notice to PNG investors';	12 Section 11.6;																				
3 Section 4.2(b);	13 Section 11.8;																				
4 Section 4.3;	14 Section 11.9;																				
5 Section 4.5;	15 Section 11.12; and																				
6 Section 6;	16 Section 11.13(b),																				
7 Section 7 as it relates to Newmont's contribution to the information regarding the Merged Group (it being noted that, to avoid doubt, Newcrest is responsible for all information in section 7 relating to the Newcrest Group or the businesses of the Newcrest Group expressly provided by or on behalf of Newcrest to Newmont in writing for use in the preparation of the Merged Group Information in that section);	in each case, excluding any Newcrest Information.																				

12. Definitions

Term	Meaning
Newmont Material Adverse Change	<p>any event, occurrence, change, condition, matter, circumstance or thing (each a Specified Event) which, whether individually or when aggregated with all such Specified Events that have occurred, has had or would be considered reasonably likely to have the effect of the consolidated net assets of the Newmont Group, taken as a whole (and net of all insurance proceeds), being reduced by an amount of at least \$3.9 billion, other than any event, occurrence, change, condition, matter, circumstance or thing:</p> <ol style="list-style-type: none">1. required or expressly permitted by the Scheme Implementation Deed or the Scheme;2. Fairly Disclosed in:<ul style="list-style-type: none">- the Newmont Disclosure Materials; or- in any statement, prospectus, report, schedule or another form filed with the SEC pursuant to the Securities Act or the Exchange Act in the 6 month period prior to 15 May 2023 (excluding any risk factor disclosure and disclosure of risks in "forward looking statement" disclaimers that are predictive, forward-looking or primarily cautionary in nature),3. agreed to in writing by Newcrest (in its sole and absolute discretion);4. resulting from any actual or announced change to any applicable law, any judicial or administrative interpretation of the law or any practice or policy of a Government Agency, including in relation to Tax;5. arising as a result of any actual or announced change in generally accepted accounting principles or standards or the interpretation of such principles or standards;6. arising as a result of any changes in general economic, industry, regulatory or political conditions, the securities or other capital markets;7. arising as a result of any geopolitical conditions, hostilities, civil or political unrest, any acts of war, sabotage, cyberattack or terrorism (including any outbreak, escalation or worsening of any of the foregoing);8. arising from any epidemic, pandemic, lightning, storm, flood, fire, seismic event or explosion, cyclone, tidal wave, landslide, natural disaster or adverse weather conditions or the like;9. arising as a result of the execution, announcement or performance of the Scheme Implementation Deed or the Scheme in accordance with its terms; or10. arising as a result of any change or fluctuation in taxation rate, interest rates, commodity prices or exchange rates, <p>except, in the case of each of the matters contemplated in items 4, 5, 6, 8 and 10, if the effects of such event, occurrence, change, condition, matter, circumstance or thing are, or would be considered reasonably likely to be, disproportionately adverse to the Newmont Group as compared to the effects on other comparable companies in the same industries as the Newmont Group, then those effects are excluded from the matters contemplated in items 4, 5, 6, 8 and 10 (as applicable) only to the extent of such disproportionate effect and not in their entirety.</p> <p>For the purposes of this definition, consolidated net assets will be calculated using the same principles as were used to calculate the consolidated net assets in Newmont's audited financial statements for the year ended 31 December 2022.</p>
Newmont Overseas	Newmont Overseas Holdings Pty Ltd ACN 667 845 454
Newmont PDI	a PETS Depositary Interest, being a unit of beneficial ownership in a Newmont Share (in the form of a PETS Depositary Interest) registered in the name of PDN in accordance with the PNGX Business Rules, to be issued to Scheme Shareholders under the Scheme

Term	Meaning
Newmont Prescribed Occurrence	<p>other than:</p> <ol style="list-style-type: none"> 1. as required or expressly permitted by the Scheme Implementation Deed or the Scheme; 2. as Fairly Disclosed in the Newmont Disclosure Materials; 3. with the consent of Newcrest (in its sole and absolute discretion); 4. in connection with an Ordinary Course Dividend; 5. in connection with Newmont conducting intra-group funding arrangements; 6. as required by law or reasonably required by any Government Agency; or 7. as Fairly Disclosed by Newmont in any statement, prospectus, report, schedule or another form filed with the SEC pursuant to the Securities Act or the Exchange Act in the 6 month period prior to 15 May 2023 (excluding any risk factor disclosure and disclosure of risks in "forward looking statement" disclaimers that are predictive, forward-looking or primarily cautionary in nature), <p>the occurrence of any of the following after the 15 May 2023:</p> <ol style="list-style-type: none"> 8. Newmont converting all or any of its shares into a larger or smaller number of shares; 9. Newmont resolving to reduce its share capital in any way; 10. Newmont entering into a buy-back agreement or resolving to approve the terms of a buy-back agreement, other than a buy-back agreement for purchases of Newmont Shares in satisfaction of the payment of the exercise price or tax withholdings upon the exercise or vesting of Newmont equity incentives; 11. a member of the Newmont Group issuing shares or securities convertible into shares, or granting a performance right or an option over its shares, or agreeing to make such an issue or grant such a performance right or an option, other than: <ul style="list-style-type: none"> – on vesting or exercise of, or in respect of, any Newmont equity incentive, or the granting of new Newmont equity incentives to a Newmont director, officer or employee under a Newmont equity incentive or employee share plan in place at 15 May 2023; – to another wholly-owned Newmont Group Member; 12. other than pursuant to the Newmont Stockholder Resolution, Newmont adopting, modifying or repealing its certificate of incorporation or by-laws, or a provision of its certificate of incorporation or by-laws; 13. a Newmont Group Member granting a Security Interest, or agreeing to grant a Security Interest, in the whole, or a substantial part, of its business or property; or 14. an Insolvency Event occurs in relation to a material Newmont Group Member.
Newmont Proxy Statement	the proxy statement, including all schedules, appendices and exhibits thereto and enclosed therewith, filed with the SEC on 5 September 2023 and first mailed or otherwise distributed to Newmont Stockholders on or about 11 September 2023 in relation to the Newmont Stockholder Meeting, as amended, supplemented or otherwise modified from time to time
Newmont Secretary	the corporate secretary of Newmont
Newmont Share	a fully paid share of common stock of Newmont to be issued to Scheme Shareholders under the Scheme
Newmont Stockholder	a holder of a Newmont Share
Newmont Stockholder Meeting	a meeting of Newmont Stockholders, including any adjournment or postponement thereof, to be held to consider and vote on the Newmont Stockholder Resolution
Newmont Stockholder Resolution	a resolution of Newmont Stockholders (approved by a majority of votes cast on such proposal) approving the issuance of Newmont Shares pursuant to the Scheme, as required by the Delaware General Corporation Law and NYSE Listing Rule 312.03
Newmont Superior Proposal	<p>a bona fide Newmont Competing Proposal not resulting from a breach by Newmont of any of its obligations in clause 14 of the Scheme Implementation Deed, which the Newmont Board, acting in good faith, and after receiving written advice from its external legal advisers and advice from its financial advisers, determines:</p> <ol style="list-style-type: none"> 1. is reasonably capable of being valued and completed within a reasonable timeframe in accordance with its terms; and 2. would, if completed substantially in accordance with its terms, result in a transaction that is more favourable to Newmont Stockholders (as a whole) than the Transaction, <p>taking into account (as a whole) all aspects of the Newmont Competing Proposal and the Transaction, including conditions, the identity, reputation and financial condition of the person making the Newmont Competing Proposal and all relevant legal, regulatory and financial matters (including the value and type of consideration, funding, any timing considerations, any conditions precedent or other matters affecting the probability of the proposal being completed), provided that, solely for the purposes of this definition of Newmont Superior Proposal, the reference to '20% or more' in paragraph 1 of the definition of Newmont Competing Proposal is replaced with '50% or more'</p>

12. Definitions

Term	Meaning
NGM	the Nevada Gold Mines joint venture between Newmont and Barrick Gold Corporation
NYSE	the New York Stock Exchange
NYSE Listing Rules	the applicable rules contained in the NYSE Listed Company Manual
Ordinary Course Dividend	has the meaning given in the Scheme Implementation Deed
Ore Reserve	has the meaning given to that term in the JORC Code
Pb	lead
PDN	the depositary nominee appointed under the PNGX Business Rules
PNG	Papua New Guinea
PNG Register	that part of the register of members of Newcrest maintained in PNG on behalf of Newcrest by PNG Registries Limited
PNGX	PNGX Markets Limited or, as the context requires, the financial market operated by it
PNGX Business Rules	the Business Rules of the Port Moresby Stock Exchange, as amended, supplemented or replaced from time to time
PNGX Listing Rules	the PNGX's Listing Rules dated 3 July 2023, as amended, supplemented or replaced from time to time
ppm	parts per million
Pretium	Pretium Resources Inc
Probable Ore Reserve	has the meaning given to that term in the JORC Code
Proved Ore Reserve	has the meaning given to that term in the JORC Code
Public Register	has the meaning given in the Scheme Implementation Deed
Red Chris	the open pit mining operation located in British Columbia which Newcrest, through its wholly owned Subsidiary, Newcrest Red Chris Mining Limited, has a 70% interest in, with the remaining 30% interest owned by a Subsidiary of Imperial Metals Corporation
Regulatory Approval	any approval of or notification to a Government Agency to the Scheme or any aspect of it, which Newcrest and Newmont agree in writing, each acting reasonably, is necessary or desirable to implement the Scheme
Related Bodies Corporate	has the meaning set out in section 50 of the Corporations Act
Relevant Interest	has the meaning given in sections 608 and 609 of the Corporations Act
Requisite Majorities	in relation to the Scheme Resolution, a resolution passed by: <ol style="list-style-type: none">1. unless the Court orders otherwise, a majority in number (more than 50%) of Newcrest Shareholders present and voting at the Scheme Meeting (either in person, online or by proxy, attorney or, in the case of corporate Newcrest Shareholders, body corporate representative); and2. at least 75% of the total number of votes cast on the Scheme Resolution at the Scheme Meeting by Newcrest Shareholders present and voting (either in person, online or by proxy, attorney or, in the case of corporate Newcrest Shareholders, body corporate representative).
Roll-Over Relief	has the meaning given in section 91(d)
Sale Agent	the nominee appointed by Newmont to sell the Newmont Shares to which an Ineligible Foreign Shareholder would otherwise have been entitled under the Sale Facility
Sale Facility	the mechanism under which the Scheme Consideration to which Ineligible Foreign Shareholders would have otherwise been entitled is sold by the Sale Agent and the proceeds remitted to Ineligible Foreign Shareholders as contemplated in section 11.5
Scheme	Annexure 3, subject to any alterations or conditions made or required by the Court under subsection 411(6) of the Corporations Act and agreed to in writing by Newmont and Newcrest
Scheme Booklet	this document being the explanatory statement in respect of the Scheme, which has been prepared by Newcrest in accordance with section 412 of the Corporations Act

Term	Meaning
Scheme Consideration	<p>the consideration to be provided by or on behalf of Newmont Overseas (or by Newmont on behalf of and at the direction of Newmont Overseas) to each Scheme Shareholder for the transfer to Newmont Overseas of each Scheme Share, being where the Scheme Shareholder holds Scheme Shares on the:</p> <ol style="list-style-type: none"> 1. Australian Register, 0.400 Newmont CDIs; 2. PNG Register, 0.400 Newmont PDIs; or 3. Canadian Register, 0.400 Newmont Shares, <p>for each Scheme Share held by the Scheme Shareholder as at the Scheme Record Date.</p> <p>For the avoidance of doubt, Ineligible Foreign Shareholders are entitled to receive 0.400 Newmont Securities, but will instead be treated in accordance with clause 5.5 of the Scheme, as described in sections 4.3 and 11.5</p>
Scheme Implementation Deed	the Scheme Implementation Deed dated 15 May 2023 between Newcrest, Newmont and Newmont Overseas
Scheme Meeting	the meeting of Newcrest Shareholders ordered by the Court to be convened under subsection 411(1) of the Corporations Act to consider and vote on the Scheme and includes any meeting convened following any adjournment or postponement of that meeting
Scheme Record Date	7:00pm on the second Business Day after the Effective Date, or such other time and date as Newcrest and Newmont agree in writing, currently expected to be Monday, 30 October 2023
Scheme Resolution	the resolution to the terms of the Scheme, as set out in the Notice of Scheme Meeting in Annexure 5
Scheme Shareholder	a holder of Newcrest Shares recorded in the Newcrest Share Register as at the Scheme Record Date
Scheme Shares	all Newcrest Shares held by the Scheme Shareholders as at the Scheme Record Date
SEC	the United States Securities and Exchange Commission
Second Court Date	the first day on which an application made to the Court for an order under paragraph 411(4)(b) of the Corporations Act approving the Scheme is heard, currently expected to be Tuesday, 17 October 2023
Second Court Hearing	the hearing of the application made to the Court for an order pursuant to section 411(4)(b) of the Corporations Act approving the Scheme
Securities Act	the United States Securities Act of 1933, as amended, and the rules and regulations thereunder
Security Interest	means any mortgage, charge, pledge, lien, assignment or other security interest or any other arrangement (including a right of set off or combination) entered into for the purpose of conferring a priority, including any security interest as defined in section 51A of the Corporations Act
SEDAR	the System for Electronic Document Analysis and Retrieval as available at www.sedar.com
Special Dividend	the cash dividend of up to \$1.10 per Newcrest Share that Newcrest may declare and pay to Newcrest Shareholders, subject to the Scheme becoming Effective and Newcrest complying with the requirements of section 254T of the Corporations Act, the Newcrest constitution and applicable law
Special Dividend Record Date	7:00pm on Thursday, 19 October 2023
Special Dividend Payment Date	Friday, 27 October 2023
State of PNG	the Independent State of Papua New Guinea
Subpart 1300	Subpart 1300 of Regulation S-K, promulgated under the Securities Act
Subsidiary	has the meaning given in section 9 of the Corporations Act

12. Definitions

Term	Meaning
Superior Proposal	a bona fide Newcrest Competing Proposal not resulting from a breach by Newcrest of any of its obligations under clause 14 of the Scheme Implementation Deed, which the Newcrest Board, acting in good faith, and after receiving written advice from its external legal advisers and advice from its financial advisers, determines: <ol style="list-style-type: none"> 1. is reasonably capable of being valued and completed within a reasonable timeframe in accordance with its terms; and 2. would, if completed substantially in accordance with its terms, result in a transaction that is more favourable to Newcrest Shareholders (as a whole) than the Transaction, taking into account (as a whole) all aspects of the Newcrest Competing Proposal and the Transaction, including conditions, the identity, reputation and financial condition of the person making the Newcrest Competing Proposal and all relevant legal, regulatory and financial matters (including the value and type of consideration, funding, any timing considerations, any conditions precedent or other matters affecting the probability of the proposal being completed), provided that, solely for the purposes of this definition of Superior Proposal, the reference to '20% or more' in paragraph 1 of the definition of Newcrest Competing Proposal is replaced with '50% or more'
Tax	any tax, levy, charge, impost, fee, deduction, goods and services tax, compulsory loan or withholding, stamp, landholder, transaction or registration duty or similar charge that is assessed, levied, imposed or collected by any Government Agency and includes any interest, fine, penalty, charge, fee or any other amount imposed on, or in respect of, any of the above
Tax Act	the <i>Income Tax Assessment Act 1936</i> (Cth) or the <i>Income Tax Assessment Act 1997</i> (Cth), or both as the context requires
Telfer	the mining operation located in Western Australia that is fully owned by Newcrest
Transaction	the proposed acquisition of the Scheme Shares by Newmont Overseas through implementation of the Scheme in accordance with the terms of the Scheme Implementation Deed and the Scheme
TSX	Toronto Stock Exchange
UK CGT	has the meaning given in section 9.3(a)(1)
UK roll-over relief	has the meaning given in section 9.3(a)(1)
UK Scheme Shareholders	has the meaning given in section 9.3
US GAAP	United States Generally Accepted Accounting Principles
VWAP	volume weighted average price
Wafi-Golpu	the project which is located in the Morobe province of PNG that is owned by the unincorporated WGJV between subsidiaries of Newcrest and Harmony, each owning a 50% interest
WGJV	Wafi-Golpu Joint Venture
WO₃	tungsten trioxide
Zn	zinc

In this Scheme Booklet, unless expressly stated or the context otherwise appears:

- a) words and phrases have the same meaning (if any) given to them in the Corporations Act;
- b) words importing a gender include any gender;
- c) words importing the singular include the plural and vice versa;
- d) an expression importing a natural person includes any company, partnership, joint venture, association, corporation or other body corporate and vice versa;
- e) a reference to a section or Annexure is a reference to a section of and an Annexure to this Scheme Booklet as relevant;
- f) a reference to any statute, regulation, proclamation, ordinance or by law includes all statutes, regulations, proclamations, ordinances, or by laws amending, varying, consolidating or replacing it and a reference to a statute includes all regulations, proclamations, ordinances and by laws issued under that statute;
- g) headings and bold type are for convenience only and do not affect the interpretation of this Scheme Booklet;
- h) a reference to time is a reference to time in Melbourne, Australia; and
- i) a reference to 'A\$' or 'AUD' is to the lawful currency of Australia, a reference to 'CAD' is to the lawful currency of Canada and a reference to 'USD' or '\$' is to the lawful currency of the United States of America.



GRANT SAMUEL

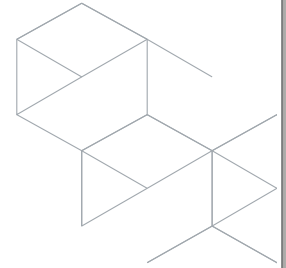

7 September 2023

The Directors
Newcrest Mining Limited
Level 8
600 St. Kilda Road
Melbourne VIC 3004

Dear Directors

Newmont Transaction

1 Introduction

On 15 May 2023, Newcrest Mining Limited ("Newcrest") announced that it had entered into a scheme implementation deed with Newmont Corporation ("Newmont") and Newmont Overseas Holdings Pty Ltd under which Newmont agreed to acquire all of the shares in Newcrest by way of a scheme of arrangement ("Scheme") and to permit Newcrest to pay a special dividend (collectively referred to as the "Newmont Transaction").

If the Newmont Transaction is implemented, Newcrest shareholders (other than ineligible foreign shareholders¹) will receive:

- 0.400 Newmont securities² for each Newcrest share held ("Scheme consideration"); and
- a franked³ special dividend of \$1.10 per share which Newcrest expects to pay on or around implementation of the scheme of arrangement.

The Scheme consideration and the special dividend are collectively referred to in this letter as the "consideration" to be received under the Newmont Transaction⁴.

The Newmont Transaction followed three earlier change of control proposals from Newmont:

NOTE:

All references to \$ in this summary letter are reference to United States dollars unless stated otherwise (e.g. Australian dollars are specifically shown as A\$).

Technical terms and other abbreviations used in this summary letter (as well as the full report and the appendices) have the meanings set out in the Glossary of Abbreviations and Technical Terms included as Appendix 1 to the full report.

¹ Ineligible foreign shareholders are Newcrest shareholders whose address shown in the Newcrest share register at the Scheme record date is outside Australia and its external territories, Canada, New Zealand, Papua New Guinea, the United Kingdom, the United States, the European Union (excluding Austria), Guernsey, Hong Kong, Japan, Norway, Singapore, South Korea, Switzerland, the United Arab Emirates, the Isle of Man and Bermuda.

² Newmont securities refers to Newmont shares, Newmont CDIs and Newmont PDIs. Newcrest shareholders who hold their shares on the Canadian Register will receive NYSE-listed Newmont shares, Newcrest shareholders who hold their shares on the Australian Register will receive ASX-listed Newmont CDIs and Newcrest shareholders who hold their shares on the PNG Register will receive PNGX-listed Newmont PDIs.

³ The franking of the special dividend amount is subject to change based on timing of implementation of the Scheme, business performance, finalisation of tax compliance matters relevant to the Newcrest Australian tax consolidated group, foreign exchange movements and an ATO Class Ruling.

⁴ Although, for the avoidance of doubt, both components of the Newmont Transaction should be considered separately in accordance with the Scheme Booklet.

GRANT SAMUEL & ASSOCIATES PTY LIMITED

ABN 28 050 036 372 AFS Licence No 240985
Level 19 Governor Macquarie Tower, 1 Farrer Place Sydney NSW 2000 GPO BOX 4301 SYDNEY NSW 2001 T +61 2 9324 4211 F +61 2 9324 4301
GRANTSAMUEL.COM.AU

Annexure 1. Independent Expert's Report

G R A N T S A M U E L



- an initial indicative, non-binding and conditional proposal at an exchange ratio of 0.363 Newmont shares for each Newcrest share held which was rejected by the Newcrest Board. The initial proposal was not announced to the market at the time it was received or rejected;
- a revised indicative, non-binding and conditional proposal at an exchange ratio of 0.380 Newmont shares for each Newcrest share held (the "Revised Proposal") which was announced to the market by Newcrest on 6 February 2023. The Revised Proposal was also unanimously rejected by the Newcrest Board, although Newcrest and Newmont signed a non-disclosure and standstill agreement under which Newcrest provided Newmont with access to limited, non-public information on a non-exclusive basis to determine if Newmont could provide an improved proposal; and
- a further revised indicative, non-binding and conditional proposal at an exchange ratio of 0.400 Newmont shares for each Newcrest share held and, in addition, permitting Newcrest to pay a franked special dividend of up to \$1.10 per share (the "Further Revised Proposal") that was announced to the market on 11 April 2023. Newmont indicated that the Further Revised Proposal represented its best and final price in the absence of a competing proposal.

The Scheme is subject to a number of conditions and regulatory approvals/clearances that are set out in Section 11.4 of the Scheme Booklet to be sent by Newcrest to its shareholders ("Scheme Booklet"). Other elements of the scheme implementation deed include customary exclusivity and competing proposal notification obligations provided by Newcrest in favour of Newmont, the potential payment in certain circumstances of a break fee by Newcrest (\$174 million) or Newmont (\$375 million) and an obligation for Newcrest to ensure that no equity incentives are in existence on the Scheme record date. In addition, Newmont must obtain shareholder approval to authorise the issue of Newmont securities as Scheme consideration.

The Newcrest Board has unanimously recommended that shareholders vote in favour of the Scheme, in the absence of a superior proposal and subject to an independent expert concluding (and continuing to conclude) that the Scheme is in the best interests of Newcrest shareholders. Subject to the same qualifications, each Newcrest director intends to vote, or cause to be voted, all shares in which they have a relevant interest in favour of the Scheme.

The directors of Newcrest have engaged Grant Samuel & Associates Pty Limited ("Grant Samuel") to prepare an independent expert's report setting out whether, in its opinion, the Newmont Transaction (including the Scheme) is in the best interests of Newcrest shareholders. A copy of the report (including this letter) will accompany the Scheme Booklet to be sent to shareholders by Newcrest. This letter contains a summary of Grant Samuel's opinion and main conclusions.

2 Opinion

In Grant Samuel's opinion, the Newmont Transaction (including the Scheme) is in the best interests of Newcrest shareholders in the absence of a superior proposal.

Assessment of the Newmont Transaction is not straightforward. Even at the best of times valuation of Newcrest is subject to considerable uncertainty and involves a high level of subjective judgement, particularly in relation to development projects and/or assets with sovereign risk. The challenges are exacerbated when the valuation is at a "point in time" but the market pricing of gold equities (which reflect key drivers such as gold price, operating costs and cost of equity, albeit in an indeterminable manner) has been highly volatile over the last few months. A wide range of valuation conclusions could credibly be reached. Accordingly, fundamental valuation analysis should be treated with caution. Other considerations such as market based measures of relative contribution of Newcrest to the Merged Group and other factors are also useful and relevant. The assessment of the Newmont Transaction is an overall conclusion having regard to all of these considerations.

Grant Samuel has valued Newcrest in the range \$16.7-18.9 billion, or \$18.64-21.13 per share.



G R A N T S A M U E L



Assessment of the consideration is based on the “cash equivalent” value of the Scheme consideration offered by Newmont. The value of the consideration was \$21.54 per Newcrest share based on the Newmont closing share price on the day prior to announcement of the Further Revised Proposal (of \$51.09) and \$19.48 per Newcrest share based on the Newmont closing share price on the day prior to announcement of the Newmont Transaction (of \$45.94) and was, on both of these dates, demonstrably “fair” (although it is not now based on current Newmont share prices).

However, Grant Samuel’s opinion is directed to the issue of whether or not Newcrest shareholders are receiving fair value for their shares today. The Newmont share price has declined substantially since announcement of the Further Revised Proposal in April 2023, falling from \$51.09 to current prices of around \$40 (a decline of over 20%). On the basis of recent trading on the NYSE and various other factors, Grant Samuel has adopted a Newmont share price trading range of \$40.00-44.00. The width of the range reflects the recent volatility in Newmont’s share price and while it is above the Latest Share Price (\$39.32), it is in line with recent trading. Accordingly, Grant Samuel has assessed the value of the consideration under the Newmont Transaction to be \$17.10-18.70 per Newcrest share⁵.

The assessed value of the consideration under the Newmont Transaction of \$17.10-18.70 per Newcrest share overlaps Grant Samuel’s estimate of the full underlying value of Newcrest of \$18.64-21.13 per share but only marginally. While it could be argued that any amount of overlap results in a transaction being “fair”, in Grant Samuel’s view, the extent of the overlap in this case is insufficient to meet the requirements for the Newmont Transaction to be “fair” in terms of ASIC’s regulatory guidelines particularly as Newmont’s Latest Share Price (\$39.32) represents consideration of only \$16.83 per Newcrest share.

However, there are good reasons to conclude that this analysis provides, at best, an incomplete assessment of the Newmont Transaction, given its scrip nature and the overall volatility in market values across the gold sector in recent months. A shareholder could validly take the view that:

- the transaction could be viewed as a merger;
- the Further Revised Proposal was demonstrably fair when it was announced on 10 April 2023 (new York time) (although it is not now based on current Newmont share prices). One perspective is that if the Newmont Transaction was a “good deal” when it was first announced in April 2023 it is still likely to be a good deal now, even if the terms are effectively somewhat less attractive on a relative basis (i.e. to the extent of Newmont’s underperformance); and
- Grant Samuel’s valuation of Newcrest is at a point in time and is a subjective view of value. In contrast, the sharemarket provides an unbiased view of value that represents a consensus of thousands of market participants. Relative contributions analysis over an extended period shows that Newcrest shareholders have consistently contributed ~25% of the market value of the Merged Group yet they are receiving ~32% of the Merged Group (taking into account the special dividend), representing a premium (or uplift) of around 30%. This premium might be regarded as more meaningful because it is not a reflection of estimates of absolute values at one point in time.

In a broader sense, the Newmont Transaction enables Newcrest shareholders to retain their direct exposure to the gold sector by “rolling up” their investment into a larger, more diversified company (the world’s largest gold miner), while capturing a meaningful premium (through the uplift in their share of the Merged Group) in the process, as well as benefitting from a higher dividend per share.

On this basis, it could be argued that the Newmont Transaction provides an exchange ratio that is equitable. In any event, irrespective of the merits of this argument, it underpins “reasonableness”. In addition:

- at the date of this report, Newmont shares are trading at 10 month lows and there are other factors that could suggest that there is some upside in the Newmont share price from these levels;

⁵ For some shareholders (e.g. Australian resident shareholders), franking credits increase the effective after tax value of the consideration (see Section 7.4.2 of the full report).

Annexure 1. Independent Expert's Report

GRANT SAMUEL



- Newmont's offer is "best and final", and therefore it cannot be increased in the absence of a superior proposal from an alternative acquirer. There are relatively few potential acquirers that have the scale and financial capacity to acquire Newcrest. Any potential alternative acquirer has had ample time to consider an acquisition proposal for Newcrest and no such proposal has been received by Newcrest to date; and
- in the absence of the Newmont Transaction (or an alternative proposal or speculation as to an alternative proposal), it is likely that the Newcrest share price would fall, at least in the short term.

While none of these alternative analyses or other factors are individually compelling, collectively they would justify Newcrest shareholders voting in favour of the Scheme.

The realisable value of the consideration will fluctuate with movements in the Newmont share price. The real test is the price at the time of the Scheme meeting on 13 October 2023. At that point, the realisable value of the consideration under the Newmont Transaction may be greater or less than the range of values assessed by Grant Samuel (of \$17.10-18.70 per Newcrest share). The recent volatility in the Newmont share price would suggest that shareholder decisions should be left as late as practically possible. If the Newmont share price recovers during this period, it could change Grant Samuel's views on fairness, although Grant Samuel's opinion would, in any event, still be that the Newmont Transaction is in the best interests of shareholders.

If a superior proposal does not emerge prior to the Scheme meeting, the choice is essentially between the Newmont Transaction and the status quo. In this case, Grant Samuel's judgement is that the Newmont Transaction (including the Scheme) would be in the best interests of Newcrest shareholders.

3 Key Conclusions

- The equity in Newcrest has been valued in the range \$16.7-18.9 billion, which corresponds to a value of \$18.64-21.13 per share

The valuation is summarised below:

NEWCREST - VALUATION SUMMARY (\$ MILLIONS)

	FULL REPORT SECTION REFERENCE	VALUE RANGE	
		LOW	HIGH
Cadia	4.3.2	7,200	8,000
Lihir	4.3.3	4,000	4,500
Telfer (including 70% interest in Havieron)	4.3.4	500	600
Red Chris (70% interest)	4.3.5	2,100	2,450
Brucejack	4.3.6	3,000	3,300
Wafi-Golpu (35% interest) ⁶	4.3.7	420	525
Exploration and development	4.4	86	86
Corporate costs (net of savings)	4.5	(550)	(585)
Investment in associates	4.6	950	990
Other assets and liabilities	4.7	492	562
Enterprise value		18,198	20,428
Adjusted net borrowings at 30 June 2023	4.8	(1,531)	(1,531)
Value of equity		16,667	18,897
Shares on issue (millions) ⁷	3.6	894	894
Value per share		\$18.64	\$21.13

⁶ The valuation approach for Wafi-Golpu takes into account the State of PNG's right to acquire up to a 30% interest in the project from Newcrest and Harmony Gold Mining Company Limited (or 15% from each joint venture participant) for a price equal to the pro-rata calculation of accumulated exploration expenditure (which is included in the value attributed to other assets and liabilities).

⁷ Shares on issue are Newcrest's 894,230,732 issued shares. The accelerated vesting of 2,814,919 equity incentives will be met by the existing 2,626,117 treasury shares with the shortfall (188,802 equity incentives at the date of this report) being cash settled.



GRANT SAMUEL



The valuation represents the estimated full underlying value of Newcrest assuming 100% of the company was available to be acquired and includes a premium for control. The value exceeds the price at which, based on current market conditions, Grant Samuel would expect Newcrest shares to trade on the ASX in the absence of a takeover offer. Shares in a listed company normally trade at a discount of 15-25% to the underlying value of the company as a whole (although this discount does not always apply).

The principal approach to valuing Newcrest's mineral assets was by DCF analysis. The valuation also reflects evidence as to value from other valuation methodologies such as multiples analysis based on earnings, mineral resources, ore reserves and production as a cross check. The NPV outputs for the producing mineral assets (Cadia, Lihir, Telfer, Red Chris and Brucejack) and advanced development projects (Wafi-Golpu) were estimated based on production scenarios developed in conjunction with, and reflecting the technical judgement of, the independent technical specialist, AMC Consultants Pty Ltd ("AMC"). Technical valuation assumptions (e.g. production and processing rates, metal grades and recovery rates, operating and capital costs and closure costs) for each scenario were reviewed in detail, and estimated, by AMC. The financial models used in the DCF analysis incorporate cash flows from 1 July 2023.

The valuation of Newcrest is fundamentally dependent on Grant Samuel's judgement as to key assumptions adopted for valuation purposes, including appropriate gold and copper prices. Future commodity prices are inherently uncertain and shareholders could reasonably form a view that different commodity price assumptions are warranted which, in turn, could lead to a different conclusion. The same considerations apply to other key assumptions such as discount rates and exchange rates.

In any event, Grant Samuel has determined an appropriate value range for each asset reflecting the NPV outcomes of the various scenarios, the evidence from other methodologies (e.g. multiples of earnings and resources) and various other factors such as location, development status, resource upside and optionality. The value is not based on any one scenario or set of assumptions.

The valuation excludes synergies that are unique to Newmont. However, it does include synergies that any acquirer of Newcrest would be able to achieve, including savings in listed company costs and other corporate overheads. These savings have been included in the negative valuation range attributed to corporate costs.

AMC prepared valuations of Newcrest's exploration and development assets for which it was not appropriate to prepare cash flow based valuations. The AMC valuation of these assets is set out in its detailed report, which is included as Appendix 7 to the full report. The value of remnant mineral resources and exploration projects or targets located at existing operations has been included in the value of those operations in the table above. The value attributed to exploration and development includes only assets at other locations.

Other assets include the value of investments in associates (e.g. Lundin Gold Inc., SolGold Plc ("SolGold"), Antipa Minerals Limited, Azucar Minerals Limited, Headwater Gold Inc. and Metallic Minerals Corporation), the value of Fruta del Norte financing facilities, a loan to Greatland Gold plc ("Greatland") in relation to Havieron, consideration receivable from the PNG Government under the assumption that it will elect to exercise the option to purchase up to 30% equity interest in Wafi-Golpu and deferred consideration in relation to the sale of the Gosowong mine in 2020.

Annexure 1. Independent Expert's Report

GRANT SAMUEL



- **The multiples implied by the overall valuation of Newcrest are blended multiples that reflect the nature, relative size and organic growth opportunities available to each of the mineral assets**

The multiples implied by Grant Samuel's valuation of Newcrest are summarised below:

NEWCREST – IMPLIED VALUATION PARAMETERS

	VARIABLE	RANGE OF PARAMETERS	
		LOW	HIGH
EBITDA			
FY23 (historical) (times)	\$2,044 million	8.4	9.5
FY24 (median broker forecast ⁸) (times)	\$2,224 million	7.8	8.7
Attributable resources and reserves^{9,10}			
Gold resources (\$/oz)	126.2Moz	137	154
Gold reserves (\$/oz)	55.2Moz	312	352
Attributable gold production			
FY23 gold production (\$/oz)	1.9Moz	8,886	10,014

The overall multiples are blended multiples for Newcrest's mineral assets that reflect the nature (e.g. operating assets vs those under development) and the relative size and organic growth opportunities available to each of the mineral assets. The overall multiples are weighted towards the valuations of Cadia and Lihir but incorporate the value of future development projects such as the Red Chris block cave expansion and the Wafi-Golpu project.

The implied EBITDA multiples are towards the high end of the range of the sharemarket evidence from the listed major gold producers and the recent transaction evidence. The implied multiples reflect a balancing of various factors. Newcrest has a number of attractive features, including its:

- scale and diversification, as one of the world's largest gold producers with a portfolio of high quality and long life mineral assets largely in "safe and predictable" mining jurisdictions such as Australia and Canada;
- long expected reserve life across a number of producing assets, including Cadia, Lihir and Red Chris (once the block cave expansion is completed);
- an established organic growth pipeline at a number of assets (e.g. Red Chris block cave expansion, Havieron expansion, the Wafi-Golpu project, etc.) and the balance sheet capacity to undertake and fund these opportunities; and
- expectations of a near-term earnings recovery as productivity improves across its portfolio, including at Cadia and Lihir both of which have experienced operating challenges over the last three years.

On the other hand, there are some countervailing factors:

- high asset concentration, particularly at Cadia and Lihir (where Lihir has higher sovereign risk than other mineral assets and projects in more stable jurisdictions); and

⁸ While Newcrest has provided guidance for FY24, the directors of Newcrest have decided not to include the FY24 forecast in the Scheme Booklet and therefore this information has not been disclosed in this report. Accordingly, the implied multiples are based on the median of brokers' forecasts for Newcrest (see Appendix 3 to the full report for details). These median forecasts are sufficiently close to Newcrest's FY24 Forecast to be useful for analytical purposes.

⁹ Attributable resources and reserves assume a 35% interest in Wafi-Golpu which is consistent with the valuation approach for Wafi-Golpu. See Section 4.3.7 of the full report for further details.

¹⁰ For the purposes of calculating these multiples, enterprise value and attributable resources and reserves exclude investments in associates (e.g. Newcrest's interest in Lundin Gold).

GRANT SAMUEL



- the substantial project execution risks (timing, cost etc) to deliver the growth pipeline, including the Red Chris block cave expansion and Havieron development project, Lihir's transition into the high grade Kapit zone and the Wafi-Golpu project.

Unlike the EBITDA multiples, the gold resource and reserve multiples are towards the middle of the range of the market evidence. While relatively high multiples might be justified by factors such as the quality jurisdictions of most of Newcrest's assets and the large copper endowment of some assets the multiples are moderated by the:

- long periods over which they will be extracted;
- large amount of remnant resource across Newcrest's mineral assets (adding to resource quantities but of low value); and
- upfront capital expenditure required to develop the projects and the associated development risks (particularly at Wafi-Golpu, Red Chris and, to a lesser extent, Telfer).

In Grant Samuel's view, the implied valuation multiples, appropriately reflect the attractive characteristics and growth outlook of Newcrest balanced against its risks.

- A significant proportion of the value of Newcrest is in its Australian mineral assets, particularly Cadia, which has been valued at \$7.2-8.0 billion**

The key assumptions adopted in the DCF analysis include:

- long term real gold prices of \$1,900-2,000/oz and real copper prices of \$8,250-8,750/t;
- a long term inflation rate of 2.5%;
- operating costs that have been estimated by AMC;
- an exchange rate of A\$1.00 = \$0.67; and
- nominal discount rates 8-9% for Cadia (which has a copper exposure of approximately 50%) and 6.5-7.5% for Telfer (which is primarily gold only).

Two valuation scenarios were developed for each of Cadia and Telfer:

- Scenario 1 for Cadia assumes gold production of 10.5Moz and copper production of 2.4Mt over the life of mine and capital expenditure of approximately \$4.7 billion over the life of mine (including growth capital expenditure for additional panel caves and additional tailing storage). Scenario 2 assumes higher recovery rates so that gold and copper production over the life of mine increase by 93koz and 13kt respectively. The dust issue at Cadia has been dealt with by increasing capital expenditure; and
- Scenario 1 for Telfer assumes that Newcrest successfully develops the Havieron project and identifies new mining fronts to extend the operating life of Telfer. Gold production over the project life is approximately 2.4Moz and copper production is approximately 100kt. In addition to sustaining capital expenditure, total capital expenditure includes upfront development costs for Havieron and growth capital expenditure to develop new Telfer underground extensions. Scenario 2 incorporates the development of incremental ore inventory (from Havieron as a result of successful resource-to-reserve conversion and at Telfer underground) so that total gold and copper production increases to 4.3Moz and 184kt respectively. Capital expenditure is also higher due to investments associated with developing new underground mining fronts.

The NPV outcomes and the valuation ranges selected by Grant Samuel are depicted diagrammatically below:



Annexure 1. Independent Expert's Report

GRANT SAMUEL

VALUE OUTCOMES (\$ MILLIONS)

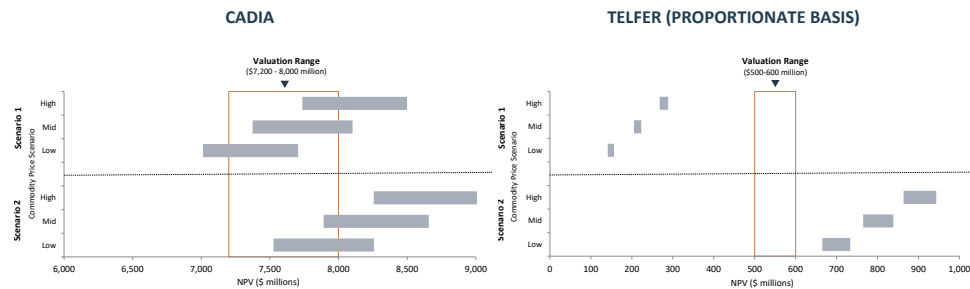

The high degree of overlap between value outcomes for Scenario 1 and Scenario 2 for Cadia reflect the operating track record of the mine (over 25 years) and limited growth profile for the asset. The valuation range reflects the uncertainty relating to the value of the very significant mineral resources and ore reserves that are assumed to remain unmined even after a 30-year mine plan (in excess of 2,000Mt in mineral resource, or around 24Moz gold and 5Mt copper), development risks in relation to the completion and ramp-up of two large scale panel caves and the subsequent development of new panel caves in succession and geotechnical risks, particularly in relation to stress building as the panel caves are developed and the supporting rock underneath the surface rock is progressively removed or mined. The value range is weighted towards the Low and Mid Scenarios in view of the current gold price relative to the long term assumption for gold prices used in the DCF analysis.

In contrast, the valuation range for Telfer is between the two Scenarios, but more towards the Scenario 2. The value of the existing mining operations at Telfer is constrained by its remaining reserve life (FY35-FY36) and is further capped by its declining free cash flow profile over that period as a result of naturally declining grades and cutback investments. Accordingly, the positive value hinges on the value of Newcrest's 70% interest in the Havieron project. The discount to the Scenario 2 NPV reflects Havieron's status as a development project that is still subject to a feasibility study (and subsequent FID). Grant Samuel also had regard to implied market valuation benchmarks (Greatland owns 30% of Havieron).

- **The valuations of Newcrest's Papua New Guinea mineral assets (Lihir and Wafi-Golpu) include subjective judgements to reflect sovereign risk as well as other project specific risks**

For the purposes of its DCF analysis Grant Samuel adopted the same nominal discount rates that were adopted for the valuations of Cadia and Telfer (i.e. 6.5-7.5% for Lihir (which is primarily gold only) and 8-9% for Wafi-Golpu (which has a large copper exposure)). Other assumptions are consistent with its valuations of Cadia and Telfer.

Two valuation scenarios were developed for Lihir. Scenario 1 assumes total gold production of 17.3Moz over the life of mine, ramping up from around 780koz of gold in FY24 to 1Moz of gold in FY27 and consistently delivering more than 1Moz of gold from FY28 to FY31 before a gradual decline in gold production as mining operations ramp down and conclude in FY42 and the remaining ore stockpile is processed for an additional five years. The majority of the \$3.3. billion in capital expenditure is sustaining in nature due to the ongoing production stripping requirements. Growth capital expenditure of approximately \$250 million is incurred to develop the near shore oil barrier. Scenario 2 represents an upside scenario where further productivity improvements are experienced driven by successful plant maintenance programs and expenditure, improved ore feed characteristics from the Kapit zone and higher milling throughput rates.

Due to Wafi-Golpu's current development stage and the expected time to development and first ore (i.e. at least five years), only one production scenario was prepared. Production progressively ramps up from FY30, with 7.6Moz of gold in concentrate production and 4.7Mt of copper in concentrate



GRANT SAMUEL



production over life of mine. Total capital expenditure is \$7.6 billion over life of mine, the majority of which is incurred as upfront investments for mine development and construction of the associated infrastructure.

The NPV outcomes and the valuation ranges selected by Grant Samuel are depicted diagrammatically below:

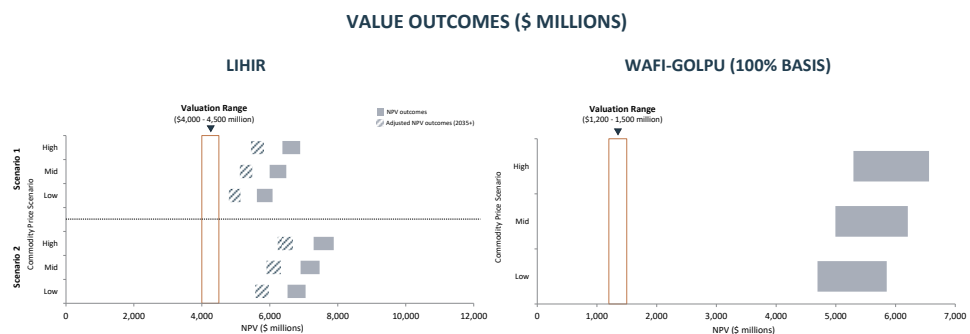

The valuation ranges for Lihir and Wafi-Golpu are below the various NPV outcomes. From the perspective of an international investor in gold companies, a mine’s location in Papua New Guinea is likely to make it less attractive than if it was located (for example) in Australia or Canada. That is (i.e. investment in Papua New Guinea carries sovereign risk). Some of the indicators of sovereign risk include Papua New Guinea’s sub-investment credit rating (rated B- by S&P and B2 by Moody’s) unlike Australia and Canada, both of which have a AAA rating across both rating agencies, recent surveys on mining and exploration companies which indicate that Papua New Guinea consistently is among the least attractive jurisdictions for investment¹¹ (whereas both Australia and Canada are favourably ranked) and estimates of country risk premium (despite its limitations) which vary across a wide range but indicate a significant risk differential between Papua New Guinea (with a country risk premium of around 8%) and “safer” jurisdictions such as Australia and Canada (which have no premium)¹² (noting that the same discount rates used to value Newcrest’s Australian and Canadian assets have been used to calculate the NPVs for Lihir and Wapi-Golpu).

In the case of Lihir, the sovereign risk issues are compounded by the expiry of Lihir’s mining leases in 2035. Despite its track record, there is no certainty that the mining lease will be renewed or, if renewed, will remain on same commercial terms (recent challenges faced by the Porgera gold mine in renewing its mining lease offers some insight to the potential magnitude of these risks). The potential impact is illustrated in the adjusted NPV outcomes in the chart above (which reduces all cash flows post 2035 by 50%). It is also necessary to allow for the geotechnical risks and specific risks associated with Lihir’s operations. It has a long history of underperformance, and while there may be sound reasons to anticipate a marked improvement going forward, any acquirer would apply a degree or scepticism to anticipated improvements. There are also environmental risks associated with the deep sea tailing placement.

The valuation range for Wafi-Golpu is at a significant discount to the NPV outcomes. In addition to sovereign risk, the cash flows do not fully capture development risk (the project has not yet received all necessary permits), project estimation risk (production and costing estimates are largely based on a 2018 feasibility study) and environmental risks associated with the deep sea tailing placement. While the discount is highly subjective, the valuation range has been benchmarked to SolGold, which shares a number of characteristics with Wafi-Golpu.

¹¹ Source: Fraser Institute, Annual Survey of Mining Companies, 2022

¹² Source: Damodaran, Aswath, Country Risk: Determinants, Measures and Implications – The 2023 Edition (July 2023).

Annexure 1. Independent Expert's Report

GRANT SAMUEL



The risks faced by Wafi-Golpu (as a greenfield project) are undoubtedly greater than those faced by Lihir (which is an established mining operation with a long track record in the country). Accordingly, a subjective discount (from the NPV outcomes) would inevitably be larger for Wafi-Golpu.

- There are valid reasons for Newcrest's Canadian mineral assets, Red Chris and Brucejack, to be valued above their relatively recent acquisition prices

For the purposes of its DCF analysis Grant Samuel adopted the same discount rates that were adopted for the valuations of Newcrest's other assets (i.e. 8-9% for Red Chris (which has a large copper exposure) and 6.5-7.5% for Brucejack (which is primarily gold only)). An exchange rate of C\$1.00 = \$0.75 has been adopted for translating costs. Other assumptions are consistent with Grant Samuel's valuations of Cadia and Telfer.

Two valuation scenarios were developed for each of Red Chris and Brucejack:

- Scenario 1 for Red Chris is based on the updated studies that have been completed since the 2021 pre-feasibility and assumes that Red Chris fully transitions from an open mining operation to an underground block cave mining operation by FY27. Total copper production of 1.7Mt and gold production of 5.1Moz is expected over the life of mine. Total capital expenditure is \$2.7 billion is primarily non-sustaining and includes \$1 billion to complete development of the Red Chris block cave and supporting infrastructure. Scenario 2 assumes that approximately 220Mt of underground inferred resource is converted into ore reserve (but East Ridge remains unmined). Mine life is extended by 12 years and there is \$100 million in incremental capital expenditure to upgrade the processing plant to support a higher throughput capacity; and
- Scenario 1 for Brucejack is based solely on the existing ore reserves at Brucejack and assumes no upsides for resource-to-reserve conversion success or debottlenecking. Gold production is approximately 3.6Moz and total sustaining capital expenditure is \$342 million over the life of mine. Scenario 2 incorporates an additional 3Moz of gold production from successful resource-to-reserve conversion and increased production capacity as a result of de-bottlenecking initiatives with an additional \$150 million in capital expenditure.

The NPV outcomes and the valuation ranges selected by Grant Samuel are depicted diagrammatically below:

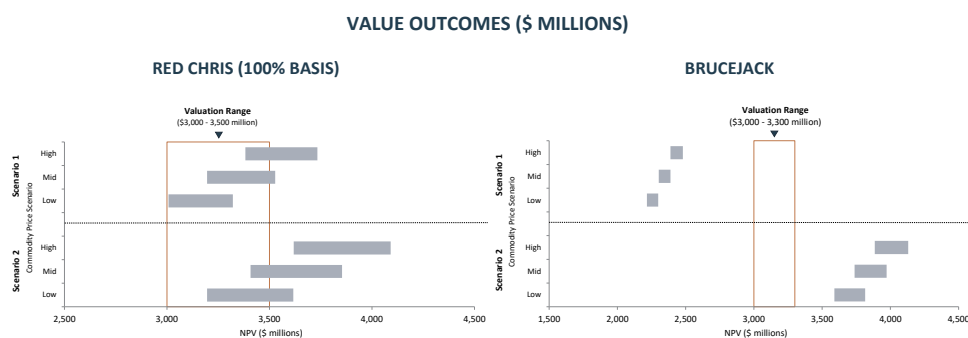

The selected valuation range for Red Chris reflects the project development risks associated with the block cave expansion and production and cost risks (as Red Chris remains in the feasibility study stage, has no track record of underground operating history and has not reached FID for development). On the other hand, these risks are mitigated to some extent by Newcrest's deep expertise and technical capabilities in block caving and similarities between the Red Chris and Cadia ore bodies. The valuation range also makes allowance for upside from East Ridge which is not reflected in the NPV outcomes and recognises the current gold price relative to the long term assumption for gold prices



GRANT SAMUEL



used in the DCF analysis. The valuation range is a substantial uplift from Newcrest's acquisition of Red Chris in 2019 and is also at a premium to the pre-feasibility study in 2021, reflecting improved copper and gold prices, exploration success and the inclusion of East Ridge.

Brucejack's valuation range is at a slight premium to the acquisition cost of Pretium Resources Inc. in 2022 (which implied an enterprise value of \$2.7 billion), reflecting subsequent early success from the debottlenecking initiatives, improved certainty of resource-to-reserve conversion profile and exploration success.

- The assessed value of the consideration under the Newmont Transaction is \$17.10-18.70 per Newcrest share based on a Newmont share price of \$40.00-44.00**

ASIC Regulatory Guide RG111 requires the Scheme consideration to be assessed assuming the transaction is completed, based on the value shareholders are receiving today rather than at the time of announcement and on a "minority interest" basis in the case of a change of control transaction. The best estimate of a minority interest is the market price of the Scheme consideration on stock exchanges (but subject to determining that this market price is not distorted or unreliable).

The analysis is directed to the "cash equivalent" value of the Scheme consideration. It is an entirely separate matter for individual shareholders to determine whether to hold or sell the Newmont securities that they receive under the Newmont Transaction, which is a separate investment decision for individual shareholders with much broader ramifications.

Having regard to these requirements, Grant Samuel has attributed a value of \$16.00-17.60 per Newcrest share to the Scheme consideration based on an estimated market value for Newmont shares of \$40.00-44.00 on a post transaction basis. While the Latest Share Price (\$39.32) is slightly below the bottom of this range, Grant Samuel believes it is appropriate based on current market conditions (including the current gold price) and recent trading patterns (Newmont shares have traded at levels below \$40.00 per share only on very rare occasions over the past 12 months and recent VWAPs have been within this range) as well as some of its market parameters compared to its peers.

Accordingly, the value of the consideration under the Newmont Transaction is \$17.10-18.70 per Newcrest share (including the special dividend of \$1.10 per share). The assessed value of the Scheme consideration relative to recent Newmont share prices is show below:

ASSESSED VALUE OF SCHEME CONSIDERATION VS NEWMONT SHARE PRICE
1 SEPTEMBER 2022 TO 1 SEPTEMBER 2023

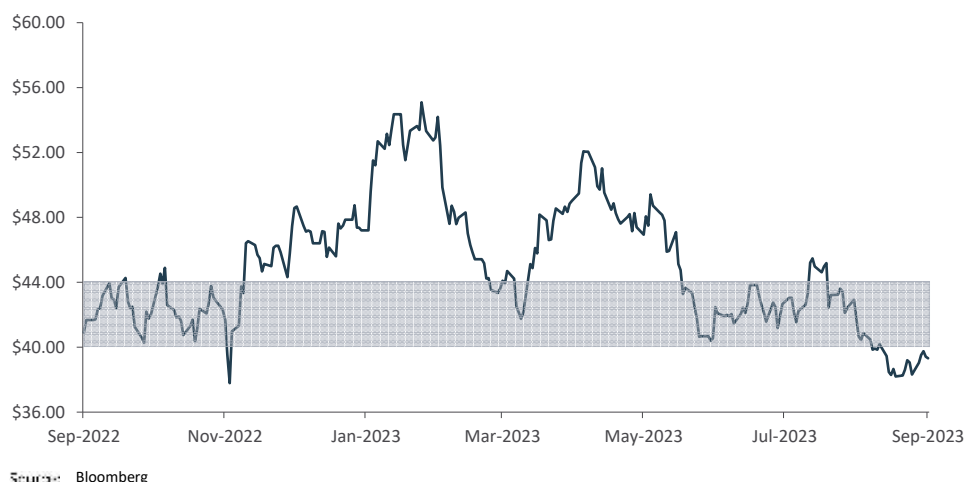

Annexure 1. Independent Expert's Report

GRANT SAMUEL



The realisable value of the Scheme consideration will fluctuate with movements in the Newmont share price. The actual value of the consideration received by Newcrest shareholders may ultimately be greater or less than the range of values assessed by Grant Samuel of \$17.10-18.70 per Newcrest share.

- The extent of the overlap between the full underlying value of Newcrest and the assessed value of the consideration is insufficient to meet the requirements for the Newmont Transaction to be "fair" in terms of ASIC's regulatory guidelines**

The assessed value of the consideration of \$18.70-19.10 overlaps Grant Samuel's estimate of the full underlying value of Newcrest of \$18.64-21.13 per share but only marginally:

NEWCREST – COMPARISON OF VALUE RANGE

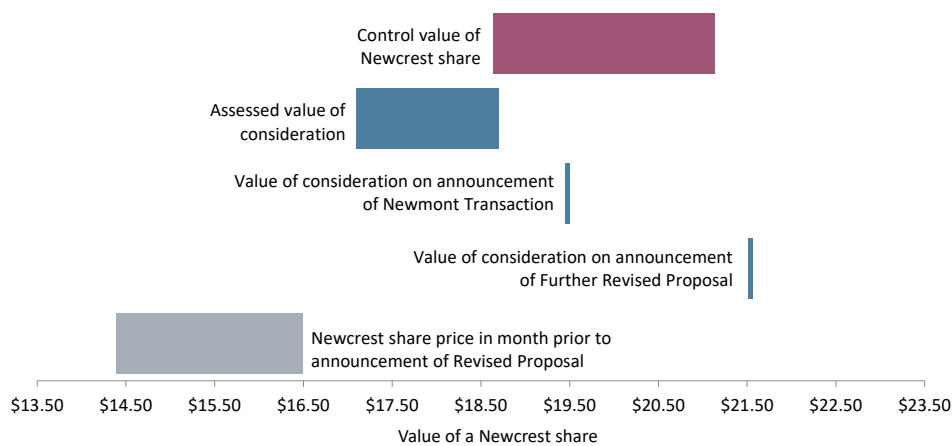

In evaluating the fairness of the Newmont Transaction, it needs to be recognised that the bottom of the valuation range for Newcrest (i.e. \$18.64) represents the relevant threshold for fairness. Usually (and particularly for a cash offer), the value of the consideration would only need to be above the bottom end of the valuation range for the transaction to be "fair".

However, the Newmont Transaction is predominantly a scrip transaction and Grant Samuel's assessment of the value of the consideration is based on a range of trading values for Newmont shares. As can be seen in the chart, only a small portion of the assessed value of the consideration falls within the valuation range.

There is no formal rule about the extent of overlap required between the valuation of the target company and the assessed value of the consideration for an offer to be regarded as "fair". There have been cases where the slightest overlap has been regarded as sufficient to meet the fairness criteria¹³.

On the other hand:

- the overlap is minimal;

¹³ See, for example, the independent expert's report dated 29 February 2016 on the merger of STW Communications Limited ("STW") with the Australian and New Zealand businesses of WPP plc ("WPP ANZ"), effected through the acquisition by STW of the shares in WPP ANZ by the issue of shares in STW to WPP plc (as a result of which WPP plc's interest in STW increased from 23.55% to 61.5%). The overlap between the independent expert's underlying value of STW shares and the assessed value of the combined group shares after the proposed merger was marginal (at only A\$0.01 cent or 7%) and the independent expert concluded that the transaction was "fair". The transaction was approved by the non-associated shareholders.



GRANT SAMUEL



- despite the overlap of the ranges the reality is that, at Newmont's Latest Share Price of \$39.32, the consideration has a value of \$16.83 per Newcrest share, \$1.81 or 10% below the bottom end of the estimated underlying value range of \$18.64. Similarly, the VWAP over the previous month gives a value for the consideration of only \$16.89, also well below the bottom of the range;
- a Newmont share price of \$43.85 is required to equate to the bottom of the value range. Other than for a brief period prior to the announcement of its 2Q23 results, Newmont shares have not traded above this level since mid-May 2023; and
- it is not necessarily appropriate to compare the top of the assessed value of the consideration range with the bottom of the estimated underlying value range as they arguably reflect different commodity price scenarios.

In Grant Samuel's view, the Newmont Transaction does not meet the requirements to be "fair" in terms of ASIC's regulatory guidelines. Newcrest shareholders will not receive full underlying value under the Newmont Transaction.

However, both the valuation of Newcrest and the assessment of the market value of the Scheme consideration are subject to material uncertainty. Shareholders could reasonably reach different conclusions based on the same information.

- **However, there are good reasons to conclude that the analysis set out above provides, at best, an incomplete assessment of the Newmont Transaction, given its scrip nature and the overall volatility in market values across the gold sector in recent months**

A shareholder could validly take the view that:

- the transaction could be viewed as a scrip based merger;
- the Further Revised Proposal was demonstrably fair when it was announced on 10 April 2023 (New York time) (although it is not now based on current Newmont share prices). While Newmont's shares have fallen by 23% since 10 April 2023, the other major gold miners¹⁴ have also fallen materially, by approximately 18% on average, over this same period. Accordingly, Newmont has only underperformed by circa 5%. One perspective is that if the Newmont Transaction was a "good deal" when it was first announced in April 2023 it is still likely to be a good deal now, even if the terms are effectively somewhat less attractive on a relative basis (i.e. to the extent of Newmont's underperformance); and
- Grant Samuel's valuation of Newcrest is at a point in time and is a subjective view of value. In contrast, the sharemarket provides an unbiased view of value that represents a consensus of thousands of market participants.

Relative contributions analysis over an extended period prior to the announcement of the Revised Proposal shows that Newcrest shareholders consistently contributed ~25% of the combined sharemarket value yet they are receiving ~32% of the Merged Group (taking into account the special dividend), representing a premium (or uplift) of around 30%. This premium might be regarded as more meaningful because it is not a reflection of estimates of absolute values at one point in time:

¹⁴ Based on an index created by Grant Samuel comprising major gold producers excluding Newmont and Newcrest.

Annexure 1. Independent Expert's Report

GRANT SAMUEL



NEWMONT TRANSACTION – NEWCREST SHARE OF COMBINED MARKET VALUE

JUNE 2021 TO FEBRUARY 2023

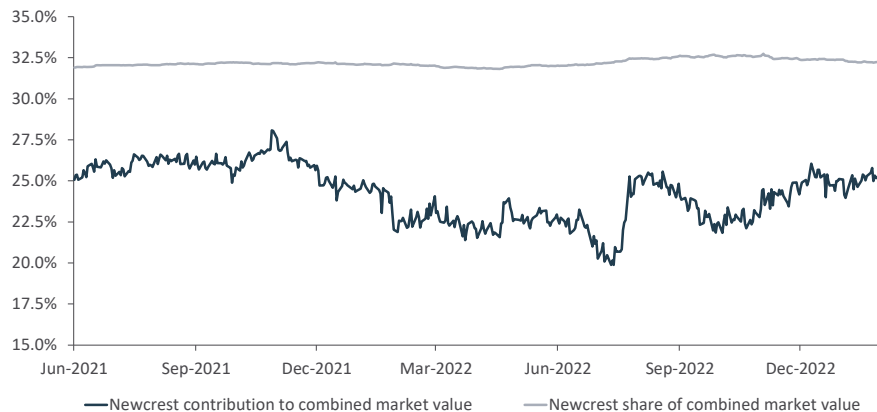

Source: IRESS, Bloomberg and Grant Samuel analysis

Notes: 1. Market capitalisation has been calculated based on shares currently on issue.

2. Newcrest shareholders' share of the combined sharemarket value includes the special dividend (\$1.10 per Newcrest share).

While the premium may have diminished to the extent that Newmont's share price has underperformed against the broader gold sector since announcement of the Further Revised Proposal, Newcrest shareholders are still receiving a substantial premium if it is assumed that Newcrest shares would have performed in line with its listed peers absent announcement of the Newmont Transaction. For this analysis to be valid, the market for Newmont and Newcrest shares needs to be well informed and well traded. In Grant Samuel's opinion, there is no reason to believe this is not the case.

In a broader sense, the Newmont Transaction enables Newcrest shareholders to retain their direct exposure to the gold sector by "rolling up" their investment into a larger, more diversified company (the world's largest gold miner), while capturing a meaningful premium (through the uplift in their share of the Merged Group) in the process, as well as benefitting from a higher dividend per share.

On this basis, it could be argued that the Newmont Transaction provides an exchange ratio that is equitable. In any event, irrespective of the merits of this argument, it underpins "reasonableness".

■ **There are also several other reasons why the Newmont Transaction could be considered reasonable and therefore would be in the best interests of Newcrest shareholders**

While the Newmont Transaction does not meet the requirements for "fairness" under ASIC regulatory guidelines, the alternative framework for assessing the Newmont Transaction underpins its reasonableness. There are also other factors that Newcrest shareholders should consider in determining whether or not to vote for or against the Scheme (and the Newmont Transaction):

- at the date of this report, Newmont shares are trading at 10 month lows and there are other factors that could suggest that there is some upside in the share price from these levels, such as a low forecast EBITDA multiple and high dividend yield relative to its peers.

Similarly, while the \$500 million per annum of synergies that Newmont expects to achieve across the Merged Group might be reflected in its market price to some extent they will inevitably be risk weighted. If Newmont is able to achieve these synergies in full (and it has demonstrated its ability to deliver synergies through its acquisition of Goldcorp) there is likely to be a positive

GRANT SAMUEL



share price response. An additional \$500 million of EBITDA is theoretically worth around \$3 billion¹⁵, or \$2.60 per Merged Group share.

At the same time, there can be no guarantee that the Newmont share price will strengthen and in any event, such an increase in the Newmont share price represents value in the future rather than value today;

- Newmont's offer is "best and final", and therefore it cannot be increased in the absence of a superior proposal from an alternative acquirer;
- there are relatively few potential acquirers that have the scale and financial capacity to acquire Newcrest. Interest from financial buyers such as private equity funds is highly unlikely given Newcrest's commodity exposure (and scale). Any interest is likely to come from either other gold sector participants or diversified miners. However:
 - large diversified miners are likely to view gold as a "niche" sector and prefer to focus on sectors such as iron ore and aluminium or "future facing" metals such as copper or nickel. Equally, investors are likely to prefer a "pure" exposure to gold rather than one buried in a larger portfolio of assets;
 - there are only two listed gold companies (apart from Newmont) that have a market capitalisation larger than Newcrest. It is quite conceivable that, if the Newmont Transaction does not proceed, shareholders will not receive any acquisition proposal from any other party within their investment horizon. In this context, Newcrest's exposure to PNG may be a deterrent to some acquirers;
 - in view of the relativities in size any proposal from another gold miner would almost certainly involve a substantial scrip component. In this situation, it would be challenging for an acquirer to pay a significant premium because of the dilutionary impact on its own shareholders and any scrip offer would face many of the same issues afflicting the Newmont Transaction. Indeed, it is possible that alternative transactions would be structured more as mergers of equals (which a large proportion of recent consolidation transactions in the sector have been) in which case Newcrest shareholders might not receive any premium for control; and
 - in a scrip based transaction synergy benefits are often a meaningful driver of value. The complementarity between Newmont's and Newcrest's asset portfolios mean that Newmont is probably in a position to generate significantly more synergies than other acquirers (and Newcrest shareholders share in 31% of those synergies, if realised);
- any potential alternative acquirer has had ample time to consider an acquisition proposal for Newcrest (since 6 February 2023) and the decline in the Newmont share price has opened a real "window of opportunity". If a superior alternative acquisition proposal does not arise prior to the Scheme meeting it would be reasonable to conclude that the Newmont Transaction delivers the best available value to Newcrest shareholders; and
- in the absence of the Newmont Transaction (or an alternative proposal or speculation as to an alternative proposal), it is likely that the Newcrest share price would fall, at least in the short term. Prior to announcement of the Revised Proposal on 3 February 2023, Newcrest shares were trading at around A\$22 (equivalent to ~\$15) (i.e. the "undisturbed" price). Since then, the listed gold sector¹⁴ has fallen by 7%. It is likely that the Newcrest share price would also be lower now than it was prior to announcement of the Revised Proposal and, in the absence of any upward

¹⁵ Calculated as \$500 million x 6.0 times (the pro forma forecast EBITDA multiple (post synergies) for the Merged Group). See Section 6.3 of the full report.

Annexure 1. Independent Expert's Report

GRANT SAMUEL



movement in the gold price, it may take some time for Newcrest' share price to increase to the levels implied by the Newmont Transaction.

4 Other Matters

This report is general financial product advice only and has been prepared without taking into account the objectives, financial situation or needs of individual Newcrest shareholders. Accordingly, before acting in relation to their investment, shareholders should consider the appropriateness of the advice having regard to their own objectives, financial situation or needs. Shareholders should read the Scheme Booklet issued by Newcrest in relation to the Newmont Transaction (including the Scheme).

Grant Samuel has not been engaged to provide a recommendation to shareholders in relation to the Scheme, the responsibility for which lies with the directors of Newcrest. In any event, the decision whether to vote for or against the Scheme is a matter for individual shareholders, based on their own views as to value and business strategy, their expectations about future economic and market conditions and their particular circumstances including risk profile, liquidity preference, investment strategy, portfolio structure and tax position. Shareholders who are in doubt as to the action they should take in relation to the Scheme should consult their own professional adviser.

Similarly, it is a matter for individual shareholders as to whether to buy, hold or sell shares in Newcrest or Newmont. These are investment decisions upon which Grant Samuel does not offer an opinion and are independent of a decision on whether to vote for or against the Scheme. Shareholders should consult their own professional adviser in this regard.

Grant Samuel has prepared a Financial Services Guide as required by the Corporations Act, 2001. The Financial Services Guide is included at the beginning of the full report.

This letter is a summary of Grant Samuel's opinion. The full report from which this summary has been extracted is attached and should be read in conjunction with this summary.

The opinion is made as at the date of this letter and reflects circumstances and conditions as at that date.

Yours faithfully

GRANT SAMUEL & ASSOCIATES PTY LIMITED



INDEPENDENT EXPERT'S REPORT
IN RELATION TO THE
NEWMONT TRANSACTION

GRANT SAMUEL & ASSOCIATES PTY LIMITED
ABN 28 050 036 372

7 SEPTEMBER 2023

Annexure 1. Independent Expert's Report

GRANT SAMUEL



FINANCIAL SERVICES GUIDE

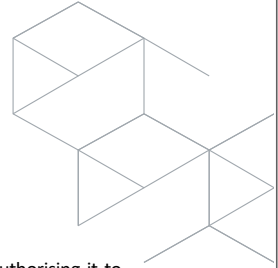

Grant Samuel & Associates Pty Limited ("Grant Samuel") holds Australian Financial Services Licence No. 240985 authorising it to provide financial product advice on securities and interests in managed investments schemes to wholesale and retail clients.

The Corporations Act, 2001 (Cth) ("Corporations Act") requires Grant Samuel to provide this Financial Services Guide ("FSG") in connection with its provision of an independent expert's report ("Report") which is included in a document ("Disclosure Document") provided to members by the company or other entity ("Entity") for which Grant Samuel prepares the Report.

Grant Samuel does not accept instructions from retail clients. Grant Samuel provides no financial services directly to retail clients and receives no remuneration from retail clients for financial services. Grant Samuel does not provide any personal retail financial product advice to retail investors nor does it provide market-related advice to retail investors.

When providing Reports, Grant Samuel's client is the Entity to which it provides the Report. Grant Samuel receives its remuneration from the Entity. In respect of the Report for Newcrest Mining Limited ("Newcrest") in relation to the proposal from Newmont Corporation ("Newmont") ("the Newcrest Report"), Grant Samuel will receive a fixed fee of A\$2.75 million plus reimbursement of out-of-pocket expenses for the preparation of the Newcrest Report (as stated in Section 8.3 of the Newcrest Report).

No related body corporate of Grant Samuel, or any of the directors or employees of Grant Samuel or of any of those related bodies or any associate receives any remuneration or other benefit attributable to the preparation and provision of the Newcrest Report.

Grant Samuel is required to be independent of the Entity to provide a Report. The guidelines for independence in the preparation of Reports are set out in Regulatory Guide 112 issued by the Australian Securities & Investments Commission on 30 March 2011. The following information in relation to the independence of Grant Samuel is stated in Section 8.3 of the Newcrest Report:

"Grant Samuel and its related entities do not have at the date of this report, and have not had within the previous two years, any business or professional relationship with Newcrest or Newmont or any financial or other interest that could reasonably be regarded as capable of affecting its ability to provide an unbiased opinion in relation to the Newmont Transaction.

Grant Samuel advises that a related entity is currently mandated by the State of PNG's Office of State Negotiations to provide commercial advice in relation to Wafi-Golpu. Grant Samuel does not consider that this assignment would have any impact on its ability to provide an unbiased opinion in relation to the Newmont Transaction.

Grant Samuel had no part in the formulation of the Newmont Transaction. Its only role has been the preparation of this report.

Grant Samuel will receive a fixed fee of A\$2.75 million for the preparation of this report. This fee is not contingent on the conclusions reached or the outcome of the Newmont Transaction. Grant Samuel's out of pocket expenses in relation to the preparation of the report will be reimbursed. Grant Samuel will receive no other benefit for the preparation of this report.

Grant Samuel considers itself to be independent in terms of Regulatory Guide 112 issued by the ASIC on 30 March 2011."

Grant Samuel has internal complaints-handling mechanisms and is a member of the Australian Financial Complaints Authority, No. 11929. If you have any concerns regarding the Newcrest Report, please contact the Compliance Officer in writing at Level 19, Governor Macquarie Tower, 1 Farrer Place, Sydney NSW 2000. If you are not satisfied with how we respond, you may contact the Australian Financial Complaints Authority at GPO Box 3 Melbourne VIC 3001 or 1800 931 678. This service is provided free of charge.

Grant Samuel holds professional indemnity insurance which satisfies the compensation requirements of the Corporations Act.

Grant Samuel is only responsible for the Newcrest Report and this FSG. Complaints or questions about the Disclosure Document should not be directed to Grant Samuel which is not responsible for that document. Grant Samuel will not respond in any way that might involve any provision of financial product advice to any retail investor.

GRANT SAMUEL & ASSOCIATES PTY LIMITED

ABN 28 050 036 372 AFS Licence No 240985
Level 19 Governor Macquarie Tower, 1 Farrer Place Sydney NSW 2000 GPO BOX 4301 SYDNEY NSW 2001 T +61 2 9324 4211 F +61 2 9324 4301

GRANTSAMUEL.COM.AU

GRANT SAMUEL



TABLE OF CONTENTS

1	Details of the Newmont Transaction _____	1
2	Scope of the Report _____	3
2.1	Purpose of the Report _____	3
2.2	Basis of Evaluation _____	3
2.3	Sources of Information _____	5
2.4	Limitations and Reliance on Information _____	6
3	Profile of Newcrest _____	9
3.1	Overview _____	9
3.2	Financial Performance _____	13
3.3	Financial Position _____	16
3.4	Cash Flow _____	19
3.5	Taxation Position _____	20
3.6	Capital Structure and Ownership _____	21
3.7	Share Price Performance _____	22
4	Valuation of Newcrest _____	25
4.1	Summary _____	25
4.2	Valuation Approach _____	28
4.3	Valuation of Newcrest's Assets _____	40
4.4	Exploration and Development Assets _____	80
4.5	Corporate Costs _____	81
4.6	Investments in Associates _____	82
4.7	Other Assets and Liabilities _____	88
4.8	Adjusted Net Borrowings _____	89
4.9	Franking Credits _____	90
5	Profile of Newmont _____	91
5.1	Overview _____	91
5.2	Financial Performance _____	97
5.3	Financial Position _____	101
5.4	Cash Flow _____	103
5.5	Capital Structure and Ownership _____	105
5.6	Share Price Performance _____	106
6	Assessment of the Value of the Consideration _____	108
6.1	Summary _____	108
6.2	Approach _____	108
6.3	Analysis of Sharemarket Trading in Newmont Shares _____	109
6.4	Impact of the Newmont Transaction _____	120
6.5	Conclusion _____	122

Annexure 1. Independent Expert's Report

GRANT SAMUEL



7	Evaluation of the Newmont Transaction _____	124
7.1	Opinion _____	124
7.2	Summary _____	124
7.3	Fairness _____	127
7.4	Alternative Framework for Assessing the Newmont Transaction _____	130
7.5	Reasonableness _____	134
7.6	Shareholder Decision _____	150
8	Qualifications, Declarations and Consents _____	151
8.1	Qualifications _____	151
8.2	Disclaimers _____	151
8.3	Independence _____	151
8.4	Declarations _____	152
8.5	Consents _____	152
8.6	Other _____	152

Appendices

- 1 Glossary of Abbreviations and Technical Terms
- 2 Profile of Newcrest Assets
- 3 Gold and Copper Markets
- 4 Broker Consensus Forecasts
- 5 Valuation Evidence from Comparable Listed Companies and Comparable Transactions
- 6 Discount Rate Considerations
- 7 Background to the Gold Futures Methodology
- 8 Technical Specialist Report by AMC Consultants Pty Ltd

All references to \$ in this report are reference to United States dollars unless stated otherwise (e.g. Australian dollars are specifically shown as A\$).

Technical terms and other abbreviations used in this report (including the summary letter, the full report and the appendices) have the meanings set out in the Glossary of Abbreviations and Technical Terms included as Appendix 1 to this report.

GRANT SAMUEL



1 Details of the Newmont Transaction

On 15 May 2023, Newcrest Mining Limited (“Newcrest”) announced that it had entered into a scheme implementation deed with Newmont Corporation (“Newmont”) and Newmont Overseas Holdings Pty Ltd under which Newmont agreed to acquire all of the shares in Newcrest by way of a scheme of arrangement (“Scheme”) and to permit Newcrest to pay a special dividend (collectively referred to as the “Newmont Transaction”).

Newmont is the world’s largest gold producer with a market capitalisation of approximately \$31 billion. It is listed on the NYSE and TSX.

If the Newmont Transaction is implemented, Newcrest shareholders (other than ineligible foreign shareholders¹) will receive:

- 0.400 Newmont securities² for each Newcrest share held (“Scheme consideration”); and
- a franked special dividend of \$1.10 per share which Newcrest expects to pay on or around implementation of the Scheme. The special dividend is expected to be franked³.

The Scheme consideration and the special dividend are collectively referred to in this report as the “consideration” to be received under the Newmont Transaction⁴.

In addition, as permitted under the scheme implementation deed:

- Newcrest has declared a final FY23 fully franked dividend of \$0.20 per share which will be paid on 18 September 2023; and
- if the Scheme has not become effective by 1 December 2023, Newcrest may declare and pay a dividend of up to \$0.10 per share per quarterly period occurring after 30 June 2023.

Ineligible foreign shareholders¹ will not receive Newmont securities. The Newmont shares which they would have otherwise received under the Scheme will be sold on the NYSE and they will receive the net cash proceeds (i.e. after deduction of any reasonable brokerage or other selling costs, taxes and charges).

The Newmont Transaction followed three earlier change of control proposals from Newmont:

- an initial indicative, non-binding and conditional proposal at an exchange ratio of 0.363 Newmont shares for each Newcrest share held. The Newcrest Board considered that the initial proposal from Newmont did not deliver sufficiently compelling value to Newcrest shareholders and, on that basis, it was rejected. The initial proposal was not announced to the market at the time it was received or rejected;
- a revised indicative, non-binding and conditional proposal at an exchange ratio of 0.380 Newmont shares for each Newcrest share held (the “Revised Proposal”). The Revised Proposal (along with the initial proposal) was announced to the market by Newcrest on 6 February 2023. This was followed by

¹ Ineligible foreign shareholders are Newcrest shareholders whose address shown in the Newcrest share register at the Scheme record date is outside Australia and its external territories, Canada, New Zealand, Papua New Guinea, the United Kingdom, the United States, the European Union (excluding Austria), Guernsey, Hong Kong, Japan, Norway, Singapore, South Korea, Switzerland, the United Arab Emirates, the Isle of Man and Bermuda.

² Newmont securities refers to Newmont shares, Newmont CDIs and Newmont PDIs. Newcrest shareholders who hold their shares on the Canadian Register will receive NYSE-listed Newmont shares, Newcrest shareholders who hold their shares on the Australian Register will receive ASX-listed Newmont CDIs and Newcrest shareholders who hold their shares on the PNG Register will receive PNGX-listed Newmont PDIs.

³ The franking of the special dividend amount is subject to change based on timing of implementation of the Scheme, business performance, finalisation of tax compliance matters relevant to the Newcrest Australian tax consolidated group, foreign exchange movements and an ATO Class Ruling.

⁴ Although, for the avoidance of doubt, both components of the Newmont Transaction should be considered separately in accordance with the Scheme Booklet.



Annexure 1. Independent Expert's Report

GRANT SAMUEL



an announcement on 16 February 2023 that the Newcrest Board had unanimously rejected the Revised Proposal as, in the Newcrest Board's opinion, it did not represent sufficient value for Newcrest shareholders. Following rejection of the Revised Proposal, Newcrest and Newmont signed a non-disclosure and standstill agreement under which Newcrest provided Newmont with access to limited, non-public information on a non-exclusive basis to determine if Newmont could provide an improved proposal; and

- a further revised indicative, non-binding and conditional proposal at an exchange ratio of 0.400 Newmont shares for each Newcrest share held and, in addition, permitting Newcrest to pay a franked special dividend of up to \$1.10 per share (the "Further Revised Proposal") that was announced to the market on 11 April 2023. Newmont indicated that the Further Revised Proposal represented its best and final price in the absence of a competing proposal. On the basis of the Further Revised Proposal, Newcrest agreed to grant Newmont the opportunity to conduct confirmatory due diligence (over approximately four weeks) to enable it to put forward a binding proposal. Newcrest also undertook confirmatory due diligence on Newmont during this period.

The Scheme is subject to a number of conditions that are set out in Section 11.4 of the Scheme Booklet to be sent by Newcrest to its shareholders ("Scheme Booklet") including approval by Newcrest's shareholders under Section 411 of the Corporations Act ("Section 411"). The Scheme is also subject to a number of regulatory approvals/clearances, including approval of competition authorities in Australia, Canada, Japan, Papua New Guinea, South Korea and the Philippines and foreign investment authorities in Australia. Clearance was received from the Canadian Competition Bureau on 18 July 2023, Papua New Guinea's Independent Consumer & Competition Commission on 1 August 2023, the Korea Fair Trade Commission on 15 August 2023 and the ACCC on 18 August 2023.

Other elements of the scheme implementation deed include the following:

- Newcrest and Newmont are subject to customary exclusivity obligations, including "no shop", "no talk" and "no due diligence" restrictions (subject to customary fiduciary exceptions). Newcrest also has notification obligations in relation to competing proposals and Newmont has a matching right in respect of any superior proposal received by Newcrest. These provisions apply from 15 May 2023 to the earlier of the implementation date, termination of the scheme implementation deed and 15 February 2024 (or such later date as agreed between Newcrest and Newmont in writing);
- break fees are payable by Newcrest (\$174 million) and Newmont (\$375 million) in certain circumstances⁵;
- Newcrest must ensure that no Newcrest equity incentives are in existence on the Scheme record date. The Newcrest Board may exercise its discretion to accelerate the vesting of all outstanding Newcrest equity incentives and/or make cash equivalent or substitute payments; and
- Newmont must obtain stockholder approval to authorise the issue of Newmont securities as consideration under the Scheme.

The Newcrest Board has unanimously recommended that shareholders vote in favour of the Scheme, in the absence of a superior proposal and subject to an independent expert concluding (and continuing to conclude) that the Scheme is in the best interests of Newcrest shareholders. Subject to the same qualifications, each Newcrest director intends to vote, or cause to be voted, all shares in which they have a relevant interest in favour of the Scheme.

⁵ Newmont is also required to reimburse Newcrest for third party costs and expenses actually incurred by Newcrest from 14 January 2023 (the date that Newcrest received the first approach from Newmont) until the Scheme meeting if the scheme implementation deed is terminated due to failure to satisfy the Newmont shareholder approval condition.



G R A N T S A M U E L



2 Scope of the Report

2.1 Purpose of the Report

Under Section 411 the Scheme must be approved by a majority in number (i.e. more than 50%) of each class of shareholders present and voting (either in person or by proxy) at the meeting, representing at least 75% of the votes cast on the resolution. If approved by Newcrest shareholders, the Scheme will then be subject to approval by the Federal Court of Australia.

Part 3 of Schedule 8 to the Corporations Regulations prescribes the information to be sent to shareholders in relation to schemes of arrangement pursuant to Section 411. Part 3 of Schedule 8 requires an independent expert's report in relation to a scheme of arrangement to be prepared when a party to a scheme of arrangement has a prescribed shareholding in the company subject to the scheme, or where any of its directors are also directors of the company subject to the scheme. In those circumstances, the independent expert's report must state whether the scheme of arrangement is in the best interests of shareholders subject to the scheme and must state reasons for that opinion.

Although there is no requirement in the present circumstances for an independent expert's report pursuant to the Corporations Act or the ASX Listing Rules, the directors of Newcrest have engaged Grant Samuel & Associates Pty Limited ("Grant Samuel") to prepare an independent expert's report setting out whether, in its opinion, the Newmont Transaction (including the Scheme) is in the best interests of Newcrest shareholders and to state reasons for that opinion.

This report is general financial product advice only and has been prepared without taking into account the objectives, financial situation or needs of individual Newcrest shareholders. Accordingly, before acting in relation to their investment, shareholders should consider the appropriateness of the advice having regard to their own objectives, financial situation or needs. Shareholders should read the Scheme Booklet issued by Newcrest in relation to the Newmont Transaction (including the Scheme).

Voting for or against the Scheme is a matter for individual shareholders based on their views as to value and business strategy, their expectations about future economic and market conditions and their particular circumstances including risk profile, liquidity preference, investment strategy, portfolio structure and tax position. Shareholders who are in doubt as to the action they should take in relation to the Scheme should consult their own professional adviser.

2.2 Basis of Evaluation

There is no legal definition of the expression "in the best interests". However, ASIC has issued RG111 which establishes guidelines in respect of independent expert's reports. RG111 differentiates between the analysis required for control transactions and other transactions. In the context of control transactions (whether by takeover bid, by scheme of arrangement, by the issue of securities or by selective capital reduction or buyback), the expert is required to distinguish between "fair" and "reasonable". A proposal that was "fair and reasonable" or "not fair but reasonable" would be in the best interests of shareholders (being the opinion required under Part 3 of Schedule 8). For most other transactions the expert is to weigh up the advantages and disadvantages of the proposal for shareholders. If the advantages outweigh the disadvantages, a proposal would be in the best interests of shareholders.

As the Newmont Transaction comprises all scrip (other than the special dividend), it could be argued to be a "merger" in which case the appropriate analysis would be to compare the value of both entities on the same basis. However, from the perspective of Newcrest shareholders, there are factors that infer that there is a "change of control" in favour of Newmont under the Newmont Transaction:

- Newcrest shareholders will collectively comprise only approximately 31% of the merged Newmont and Newcrest group (the "Merged Group");



Annexure 1. Independent Expert's Report

GRANT SAMUEL



- on the date of announcement of the Further Revised Proposal, the agreed terms implied a premium for Newcrest's shareholders of 45% compared to the undisturbed price of Newcrest shares (i.e. the last day of trading prior to announcement of the Revised Proposal);
- in a "merger", one important factor is that shareholders who rollover into the merged entity are not necessarily losing their opportunity to capture a control premium (and therefore do not need to receive one in the transaction) because the merged entity may itself be taken over at a future date (assuming it has an open share register). However, in this case, Newmont is the world's largest gold miner and will continue to be so by an even larger margin post the Newmont Transaction. Accordingly, the prospects of Newmont securityholders (including former Newcrest shareholders) receiving a takeover offer (including a control premium) are, arguably, remote. In other words, Newcrest shareholders are effectively forgoing their opportunity for a future control premium as part of the Newmont Transaction;
- Gregory Boyce, the Chair of the Newmont Board will continue his role following the implementation of the Newmont Transaction. The Newmont Board will invite two current Newcrest directors to join the Newmont Board, representing only two out of a total of 14 Newmont directors; and
- Tom Palmer and Karyn Ovelmen, the Newmont CEO and CFO, will continue in those roles for the Merged Group. The balance of the senior management team will be determined by the Board of the Merged Group.

While it is important to distinguish control at a management/board level from control from a shareholder perspective, having regard to these factors, Grant Samuel considers it appropriate to evaluate the Newmont Transaction as a control transaction. It is economically the same as a takeover offer and control of the Merged Group will not be equally shared between the "bidder" (in this case Newmont) and "target" (Newcrest).

In this case, fairness involves a comparison of the offer price with the value that may be attributed to the securities that are the subject of the offer based on the value of the underlying businesses and assets. For this comparison, value is determined assuming 100% ownership of the target and a knowledgeable and willing, but not anxious, buyer and a knowledgeable and willing, but not anxious, seller acting at arm's length. In contrast, the consideration is valued at its "market" value (i.e. the cash equivalent value a minority shareholder could realise for its holding). Grant Samuel has determined whether the Newmont Transaction is fair by comparing the estimated underlying value range of Newcrest with the assessed market value of the consideration to be received by Newcrest shareholders. The Newmont Transaction will be fair if the assessed value of the consideration falls within the estimated underlying value range of Newcrest.

Reasonableness involves an analysis of other factors that shareholders might consider prior to accepting an offer. Fairness is a more demanding criteria. A "fair" offer will always be "reasonable" but a "reasonable" offer will not necessarily be "fair". An offer could be considered "reasonable" if there were valid reasons to accept the offer notwithstanding that it was not "fair". A fair offer is one that reflects the full market value of a company's businesses and assets. An offer that is in excess of the pre-bid market prices but less than full value will not be fair but may be reasonable if shareholders are otherwise unlikely in the foreseeable future to realise an amount for their shares in excess of the offer price. This is commonly the case where the bidder already controls the target company. In that situation the minority shareholders have little prospect of receiving full value from a third party offeror unless the controlling shareholder is prepared to sell its controlling shareholding.

In considering whether the Newmont Transaction is reasonable, the factors that have been considered include:

- the existing shareholding structure of Newcrest including significant shareholdings and any interest already held by Newmont;





GRANT SAMUEL



- the likelihood of an alternative offer and alternative transactions that could realise fair value;
- the likely market price and liquidity of Newcrest shares in the absence of the Newmont Transaction; and
- other advantages and disadvantages for Newcrest shareholders of approving the Newmont Transaction.

However, because of the scrip based nature of the transaction, Grant Samuel has also considered elements of merger analysis (e.g. relative contribution across various metrics) as an alternative basis of evaluation.

2.3 Sources of Information

The following information was utilised and relied upon, without independent verification, in preparing this report:

Publicly Available Information

- the Scheme Booklet (including earlier drafts);
- annual reports of Newcrest for FY20, FY21 and FY22;
- financial results of Newcrest for FY23;
- quarterly reports of Newcrest for FY20, FY21, FY22 and FY23;
- annual reports of Newmont for CY20, CY21 and CY22;
- quarterly reports of Newmont for 1Q23 and 2Q23;
- press releases, public announcements, media and analyst presentation material and other public filings by Newcrest and Newmont including information available on its website (e.g. feasibility studies, technical reports);
- public reports, presentations and press releases by Lundin Gold Inc. ("Lundin Gold") such as the NI 43-101 Technical Report - Fruta del Norte mine (dated 29 March 2023) ("Fruta del Norte Technical Report");
- brokers' reports and recent press articles on Newcrest, Newmont and Lundin Gold as well as the gold sector;
- sharemarket data and related information (including public releases) on Australian and international listed companies engaged in gold production and on acquisitions of companies and businesses in this sector; and
- industry statistics and gold and copper price forecasts by various research houses.

Non Public Information provided by Newcrest

- financial models for Cadia, Lihir, Telfer and Havieron, Red Chris, Brucejack and Wafi-Golpu;
- key commercial terms of the memorandum of understanding between the Government of Papua New Guinea, Harmony Gold Mining Company Limited ("Harmony Gold") and Newcrest in relation to Wafi - Golpu;
- budget for FY24 ("FY24 Budget") prepared by Newcrest management;
- studies and technical information relating to Newcrest's assets;
- management reports and strategy documents; and
- other confidential documents, board papers, presentations and working papers.



Annexure 1. Independent Expert's Report

GRANT SAMUEL



In preparing this report, representatives of Grant Samuel visited mine sites at Cadia, Telfer (inclusive of Havieron), Lihir, Red Chris and Brucejack. Grant Samuel has also held discussions with, and obtained information from, senior management of Newcrest and its advisers.

Grant Samuel was not given access to non-public information (including financial and operational information) for Newmont but held a discussion with senior management of Newmont.

2.4 Limitations and Reliance on Information

Grant Samuel believes that its opinion must be considered as a whole and that selecting portions of the analysis or factors considered by it, without considering all factors and analyses together, could create a misleading view of the process employed and the conclusions reached. Any attempt to do so could lead to undue emphasis on a particular factor or analysis. The preparation of an opinion is a complex process and is not necessarily susceptible to partial analysis or summary.

Grant Samuel's opinion is based on economic, sharemarket, business trading, financial and other conditions and expectations prevailing at the date of this report. These conditions can change significantly over relatively short periods of time. If they did change materially, subsequent to the date of this report, the opinion could be different in these changed circumstances.

This report is also based upon financial and other information provided by Newcrest and its advisers. Grant Samuel has considered and relied upon this information. Newcrest has represented in writing to Grant Samuel that to its knowledge the information provided by it was then, and is now, complete and not incorrect or misleading in any material respect. Grant Samuel has no reason to believe that any material facts have been withheld.

The information provided to Grant Samuel has been evaluated through analysis, inquiry and review to the extent that it considers necessary or appropriate for the purposes of forming an opinion as to whether the Newmont Transaction is in the best interests of Newcrest shareholders. However, Grant Samuel does not warrant that its inquiries have identified or verified all of the matters that an audit, extensive examination or "due diligence" investigation might disclose. While Grant Samuel has made what it considers to be appropriate inquiries for the purposes of forming its opinion, "due diligence" of the type undertaken by companies and their advisers in relation to, for example, prospectuses or profit forecasts, is beyond the scope of an independent expert's report. Grant Samuel is not in a position, nor is it practicable, to undertake its own "due diligence" investigation of the type undertaken by accountants, lawyers or other advisers.

Accordingly, this report and the opinions expressed in it should be considered more in the nature of an overall review of the anticipated commercial and financial implications rather than a comprehensive audit or investigation of detailed matters.

An important part of the information used in forming an opinion of the kind expressed in this report is comprised of the opinions and judgement of management. This type of information was also evaluated through analysis, inquiry and review to the extent practical. However, such information is often not capable of external verification or validation.

Preparation of this report does not imply that Grant Samuel has audited in any way the management accounts or other records of Newcrest or Newmont. It is understood that the accounting information that was provided was prepared in accordance with generally accepted accounting principles and in a manner consistent with the method of accounting in previous years (except where noted).

AMC Consultants Pty Ltd ("AMC") was appointed as technical specialist to review the operations and exploration assets of Newcrest for Grant Samuel. The report prepared by AMC is attached to, and forms part of, this report (see Appendix 7). AMC has disclosed in its report that it has previously undertaken work for both Newcrest and Newmont (and, in the case of Newmont, this work is continuing). Grant Samuel



GRANT SAMUEL



discussed these roles with AMC and formed the view that AMC was independent for the purpose of preparing a technical specialist's report in relation to Newcrest's major mineral assets for the following reasons:

- there are a limited number of appropriately qualified technical specialists (in terms of experience, depth of resources, availability etc) and it is inevitable that any technical specialist will have previously undertaken roles for a major industry participant such as Newcrest; and
- the real issue is whether AMC has undertaken work for Newcrest where, if it was appointed as technical specialist to review the operations and exploration assets of Newcrest for Grant Samuel, it would effectively be "marking its own homework".

Grant Samuel concluded that, based on its discussions with AMC, the assignments undertaken by AMC were restricted in scope and technical in nature and did not impact AMC's ability to form an independent view of the production profiles, operating costs and capital expenditure requirements for each of Newcrest's major mineral assets.

The information provided to Grant Samuel and AMC included geological data, mine development plans, operating models and studies for Newcrest's key assets. Newcrest is responsible for the information contained in the mine development plans, forecasts and studies (the "forward looking information"). Grant Samuel and AMC have considered and, to the extent deemed appropriate, relied on this information for the purpose of their analysis.

AMC conducted a detailed review of the significant assumptions and technical factors underlying the forward looking information provided by Newcrest to AMC and Grant Samuel. This process included reviews of the:

- basis on which mineral resources and ore reserves⁶ have been estimated;
- development plans and production profiles;
- expected future operating, capital and rehabilitation costs;
- expected future gold and copper recovery rates;
- potential for the conversion of resources to reserves and the potential to mine mineralisation not currently in reserves (reserve extensions);
- environmental factors; and
- other factors that AMC deemed appropriate.

Having regard to these reviews, AMC made its own independent judgements regarding the technical assumptions that can reasonably be adopted for the purpose of the valuation of Newcrest's operating (or planned to become operating) assets ("technical valuation assumptions"). AMC also prepared valuations of Newcrest's exploration interests.

On the basis of the information provided to Grant Samuel and AMC, and the review conducted by Grant Samuel and AMC of this information, Grant Samuel and AMC have concluded that the forward looking information was generally prepared appropriately and accurately based on the information available to management at the time and within the practical constraints and limitations of the forward looking information. Grant Samuel and AMC have concluded that the forward looking information does not reflect any material bias, either positive or negative. Grant Samuel has no reason to believe otherwise. Where AMC or Grant Samuel believed the Newcrest forward looking production profiles or costs were not appropriate then the production profiles or costs were modified by AMC. However, the achievability of the

⁶ The reporting of mineral resources and ore reserves is defined under the JORC Code. For the purposes of this report, "resources" and "mineral resources" are used interchangeably (and likewise, "reserves" and "ore reserves").

Annexure 1. Independent Expert's Report

GRANT SAMUEL



forward looking information is not warranted or guaranteed by Grant Samuel. Future profits and cash flows are inherently uncertain. They are predictions by management of future events that cannot be assured and are necessarily based on assumptions, many of which are beyond the control of the company or its management. Actual results may be significantly more or less favourable. Moreover, the forward looking information provided by Newcrest was not originally generated for, and may not be appropriate in the context of, a valuation of the assets of Newcrest.

As part of its analysis, Grant Samuel has developed cash flow models on the basis of the technical valuation assumptions deemed appropriate by AMC and other economic, financial and operating assumptions adopted by Grant Samuel. Grant Samuel has reviewed the sensitivity of net present values calculated from these cash flow models to changes in key variables. The analysis isolates a limited number of assumptions and shows the impact of the expressed variations to those assumptions. No opinion is expressed as to the probability or otherwise of those expressed variations occurring. Actual variations may be greater or less than those modelled. In addition to not representing best and worst outcomes, the sensitivity analysis does not, and does not purport to, show the impact of all possible variations to the business model. The actual performance of the business may be negatively or positively impacted by a range of factors including, but not limited to:

- variations to the assumptions other than those considered in the sensitivity analysis;
- greater or lesser variations to the assumptions considered in the sensitivity analysis than those modelled; and
- combinations of different variations to a number of different assumptions that may produce outcomes different to the combinations modelled.

In forming its opinion, Grant Samuel has also assumed that:

- matters such as title, compliance with laws and regulations and contracts in place are in good standing and will remain so and that there are no material legal proceedings, other than as publicly disclosed;
- the assessments by Newcrest and its advisers with regard to legal, regulatory, tax and accounting matters relating to the Newmont Transaction are accurate and complete;
- the information set out in the Scheme Booklet sent by Newcrest to its shareholders is complete, accurate and fairly presented in all material respects;
- the publicly available information relied on by Grant Samuel in its analysis (including information on Newmont) was accurate and not misleading;
- the Newmont Transaction will be implemented in accordance with its terms; and
- the legal mechanisms to implement the Newmont Transaction are correct and will be effective.

To the extent that there are legal issues relating to assets, properties, or business interests or issues relating to compliance with applicable laws, regulations, and policies, Grant Samuel assumes no responsibility and offers no legal opinion or interpretation on any issue.



GRANT SAMUEL



3 Profile of Newcrest

3.1 Overview

Background

Newcrest was formed in 1990 through the merger of Newmont Australia Limited (a former subsidiary of Newmont) and BHP Gold Limited. The merger created Australia's largest pure play gold producer with interests across some of the most profitable gold mines in the country at the time and consolidated the ownership structure of the Telfer gold mine under a single entity (previously a joint venture between the two merged groups).

Following the merger, Newcrest undertook an expansionary strategy to establish the company as a global leader in gold mining and exploration. Investments in exploration across prospective areas in Australia and other international locations led to new mineral discoveries. The most promising of these discoveries, the Cadia Valley copper-gold deposits in New South Wales ("Cadia"), was uncovered in 1992 and, by 1998, had been developed into an open pit mining operation. This was followed by discoveries of the Gosowong deposit in Indonesia in 1995 (mining operations commenced in 1999) and the Cracow deposit in Queensland in 1999 (mining operations commenced in 2004) as well as the establishments of joint ventures for the Wafi-Golpu (Papua New Guinea) and Namosi (Fiji) gold projects. The merger with Lihir Gold Limited ("LGL") in 2010 cemented Newcrest's leading position in the broader Asia Pacific region as it consolidated the large scale Lihir gold mine, as well as other smaller mines such as Mt Rawdon (Australia) and Bonikro (Côte d'Ivoire).

Over the next decade, Newcrest focused on developing its core mineral assets. The downturn in gold prices between 2011 and 2015 provided a catalyst for the company to reinvest and optimise its asset portfolio. In particular, Newcrest invested a substantial amount of capital during this period to expand its core mining operations:

- at Cadia, following the introduction of underground mining of the Ridgeway deposit via sub-level caving in the early 2000s, the Cadia East block cave mine commenced production in 2012. The \$2-billion expansion was Newcrest's first block cave mining operation and became the largest underground mine in Australia; and
- at the Lihir gold mine, where Newcrest completed a major upgrade to the processing facility via the "million ounce processing upgrade" ("MOPU"), at a cost of well over \$1 billion, as well as a series of other major maintenance initiatives in 2012-2014 to restore the plant's productivity.

The focus on enhancing its exposure to world class, long life, low cost, high margin assets and a shift from West Africa to the Americas led to divestments of a number of non-core assets, including Cracow and Mt Rawdon (divested via a demerger into a separate listed entity in 2011) as well as Bonikro (sold in 2017) and Gosowong (sold in 2020). As the gold market recovered in the latter half of the decade, Newcrest renewed its push to expand overseas into other leading mining jurisdictions by:

- establishing a strategic partnership with Lundin Gold, which wholly owns the Fruta del Norte gold mine in Ecuador. Newcrest initially acquired a 27% interest in Lundin Gold in 2018 (later increasing the stake to 32% with the acquisition of a 4.9% stake in Lundin Gold from Kinross Gold Corporation) and acquired the gold prepay and stream facilities and an offtake agreement with respect of the Fruta del Norte gold mine (see Section 3.3);
- acquiring a 70% interest in the Red Chris copper-gold mine in 2019 for \$804 million via a joint venture transaction with Imperial Metals Corporation. Red Chris is located in the prospective Golden Triangle region in Canada, offering significant high quality asset potential and the ability for Newcrest to apply its block caving skill set; and

Annexure 1. Independent Expert's Report

GRANT SAMUEL



- acquiring the Brucejack gold mine in 2022 as part of Newcrest's acquisition of Pretium Resources Inc. ("Pretium") (implied enterprise value on 100% basis of \$2.7 billion). The transaction gave Newcrest immediate operational and financial diversification in Canada as well as potential district-level synergies given its proximity to Red Chris.

Today, Newcrest is one of the largest gold producers in the world, with a portfolio comprising predominantly long life mines and a strong pipeline of brownfield and greenfield exploration projects. Newcrest has operations in Australia, PNG and Canada, several interests in development projects (i.e. PNG, Australia and Fiji), an equity holding in an operation in Ecuador, and widespread exploration activities (i.e. Canada, Australia, the United States and Ecuador). Prior to announcement of the Revised Proposal, Newcrest was one of the 25 largest entities listed on the ASX with a market capitalisation of approximately A\$20 billion (equivalent to \$14 billion⁷).

Mineral Assets

Newcrest operates a portfolio of five producing gold and copper mining operations in Australia (Cadia and Telfer), Papua New Guinea (Lihir) and Canada (Red Chris and Brucejack). It holds an effective 32% interest in the Fruta del Norte mine in Ecuador (through its investment in Lundin Gold) as well as joint venture interests in several advanced development projects (e.g. Wafi-Golpu in Papua New Guinea, Havieron in Western Australia and Namosi in Fiji).

The company has exploration interests globally, with a focus on Australia, North and South America.

The following map shows the location of Newcrest's mineral assets:

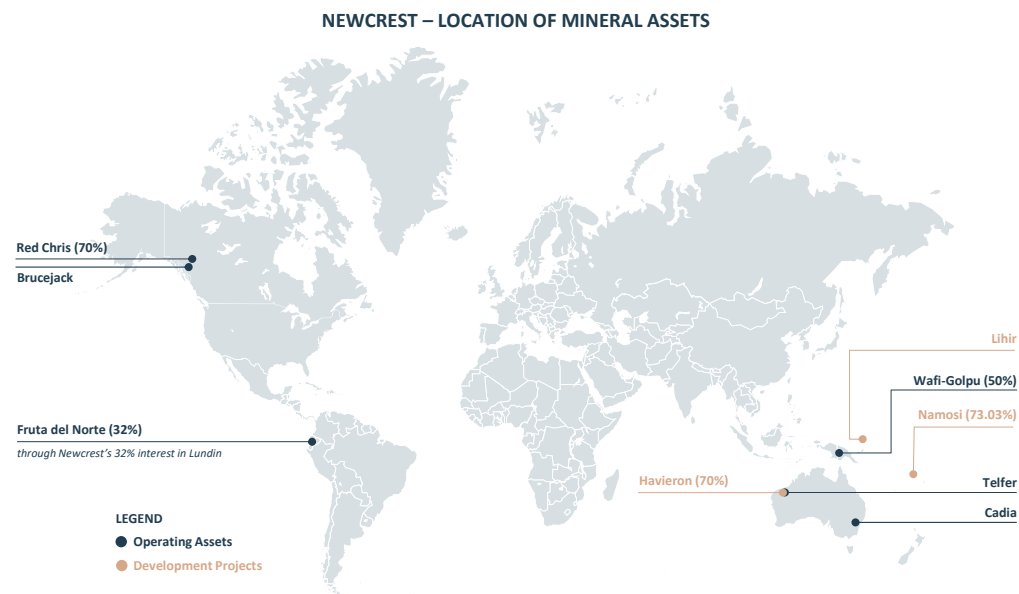

An overview of each of Newcrest's mineral assets is set out in Appendix 2 to this report.

⁷ Based on an A\$/US\$ exchange rate of 0.7062 at 3 February 2023.



GRANT SAMUEL



Newcrest produces:

- gold doré, which is an intermediate alloy that primarily comprises gold but may also contain copper, silver and other metals and requires further refining to produce gold bullion. Newcrest has several long-term refining agreements in place (e.g. the Western Australia Mint in Perth, ABC Refinery in Sydney and MKS Pamp in Canada) to produce gold bullion that Newcrest then sells to its customers;
- copper concentrate, which is an intermediate copper product that requires further smelting and refining to produce copper metal (which is more readily marketable and accordingly has an active trading market). Newcrest's copper concentrate products generally have elevated gold content; and
- other products such as silver by-products and molybdenum concentrate.

The majority of Newcrest's revenue is from the sale of gold (approximately half in the form of gold bullion), with the remainder from the sale of copper concentrate:

NEWCREST – CONTRIBUTION TO FY23 REVENUE

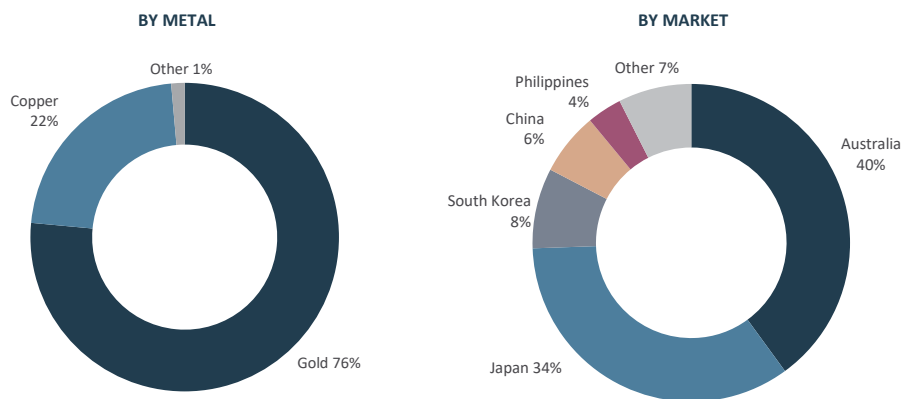

Source: Newcrest

Gold bullion is typically sold to customers at spot prices. Copper concentrate is sold to smelters located predominantly in Asia (under sales contracts with the smelter or through merchants who on-sell to smelters under their own supply arrangements).

Reserves and Resources

Newcrest's gold operations are supported by the long reserve lives at its key assets (e.g. the two largest assets, Cadia and Lihir, have estimated reserve lives of 30+ years and 20+ years). In addition, Newcrest has material copper exposure (particularly at Cadia, Red Chris and Wafi-Golpu). Newcrest's reported mineral resources and ore reserves are summarised below:

Annexure 1. Independent Expert's Report

GRANT SAMUEL



NEWCREST – REPORTED RESOURCES AND RESERVES AT 30 JUNE 2023 (100% BASIS)^{8,9}

	TOTAL RESOURCES			TOTAL RESERVES		
	GOLD (MOZ)	COPPER (MT)	SILVER (MOZ)	GOLD (MOZ)	COPPER (MT)	SILVER (MOZ)
AUSTRALIA						
Cadia	36.7	8.3	64.6	17.4	3.6	27.7
Telfer (incl Havieron, Satellites Deposits and O'Callaghans)	9.3	0.7	-	2.4	0.1	-
CANADA						
Red Chris	14.1	4.1	-	7.8	2.0	-
Brucejack	12.2	-	25.1	3.7	-	14.0
OTHER COUNTRIES						
Lihir	45.3	-	-	22.5	-	-
Wafi-Golpu	27.2	8.8	52.6	11.0	4.9	-
Namosi	6.9	8.0	-	-	-	-
Total Newcrest	151.6	29.8	142.3	64.8	10.7	41.7
<i>Total Newcrest (attributable share)</i>	<i>130.3</i>	<i>22.0</i>	<i>116.0</i>	<i>56.4</i>	<i>7.6</i>	<i>41.7</i>

Source: Newcrest and Grant Samuel analysis

The majority of Newcrest's mineral resources and ore reserves are attributable to Cadia and Lihir mines. The pre-development Wafi-Golpu project also contributes a significant proportion of Newcrest's gold and copper reserves and resources.

Strategy

Newcrest's long-term objective is to deliver profitable organic growth in a safe and sustainable manner from its portfolio of high quality, long-life mineral assets. Newcrest aims to:

- maintain and grow its gold and copper production over the long term through large scale, long life assets underpinned by a large existing resource and reserve base, a high quality portfolio of exploration and development opportunities and capital availability; and
- continually improve unit costs and capital cost efficiency through technological innovation and operational discipline.

In February 2021, Newcrest announced a new *Forging an Even Stronger Newcrest* strategy that sets out its nearer-term growth aspirations through 2025. The refreshed strategy recognises the company's strong technical capabilities across the gold production value chain (from exploration through mining and processing), its distinctive capabilities in block caving as well as the attractive qualities of its gold and copper assets (long reserve lives and low cost operations).

The refreshed strategy recognises the critical role of organic growth opportunities across Newcrest's global portfolio. Gold production has tailed off since FY19 but is now positioned to return to growth by exploiting opportunities that include:

- the Cadia expansion, which includes the development of Panel Cave 1-2 ("PC1-2")¹⁰ and PC2-3;
- the Lihir expansion, which includes development of the Phase 14A cutback and mine optimisation investments;
- the Havieron development, which has the potential to extend the operating life of Telfer; and

⁸ Mineral resources are inclusive of mineral reserves. All mineral resources and reserves are reported on a 100% basis (other than attributable share resources and reserves). Numbers may not add due to rounding.

⁹ The mineral resources and ore reserves in the table are reported at 30 June 2023 but may reflect individual mineral resource or ore reserves for each asset that were prepared at earlier dates.

¹⁰ PCXX = panel cave xx (i.e. PC1 is Panel Cave 1). Numbering of the panel caves is based on the mining area as defined by Newcrest.



GRANT SAMUEL



- the Red Chris block cave expansion, which has the potential to extend the mine life by 30 years and produce 4.9Moz of gold and 1.5Mt of copper (before taking into account the opportunity to further increase and re-sequence higher grade production through the East Ridge target)

Execution of this strategy has required (and will continue to demand) significant amounts of capital. Collectively, these organic growth investments are estimated to require more than \$5 billion in capital expenditure through to 2030 (some of which has already been incurred) but should lead to an extended period of “harvesting” with strong cash flows available to shareholders.

The refreshed strategy also recognises the importance of discoveries and greenfield opportunities in underpinning sustainable production. The company continues to advance development projects such as the Wafi-Golpu project, for which a memorandum of understanding has been signed with the Independent State of PNG in relation to the development of the project (the “Wafi-Golpu MoU”).

Further details on each of these growth opportunities are set out in Appendix 2.

3.2 Financial Performance

Background

Newcrest’s annual gold production and capital expenditure since the Lihir transaction (completed in FY11) are presented in the chart below:

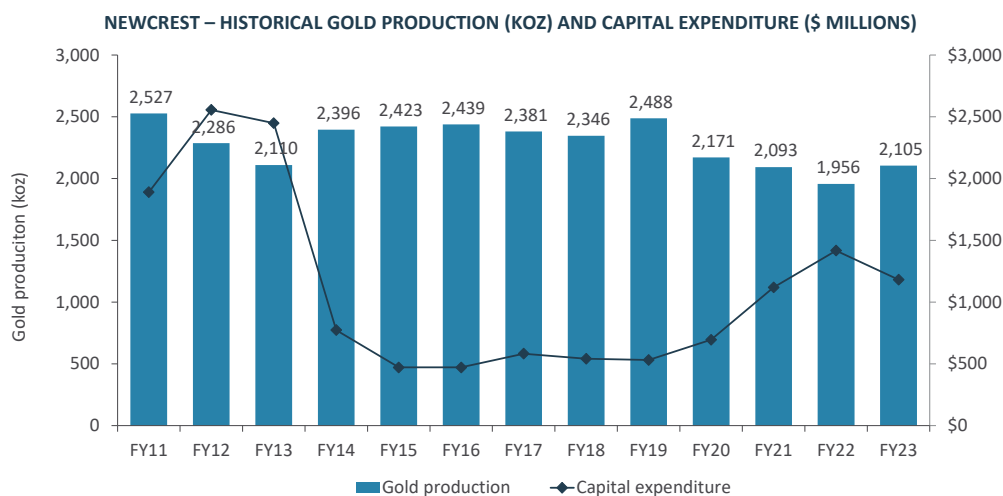

Source: Newcrest and Grant Samuel analysis

Following a period of heightened capital investments in the years leading up to FY13, Newcrest delivered stable production levels of around 2,300-2,500koz of gold per annum over the next six years, underpinned by the ramp-up of underground mining operations at Cadia East and the expansion of processing capacity and improved productivity at Lihir. This period can be generally characterised as the “harvesting” years for Newcrest and the combination of rebounding gold prices and minimal capital spend enabled the company to generate nearly \$4 billion of free cash flows between FY14 and FY19.

However, capital expenditure has increased significantly since FY20. More than \$4 billion was invested between FY20 and FY23 (twice the amount in the preceding three year period) with a major mine expansion at Cadia and sustaining capital expenditure programs absorbing a large share of the capital invested. Gold production volumes declined as average gold head grades declined. The combination of planned and unplanned downtimes at Cadia and Lihir contributed to further reductions in gold production.

Annexure 1. Independent Expert's Report

GRANT SAMUEL



While inorganic growth (including the acquisitions of Red Chris and Brucejack as well as the investment in Lundin Gold) has helped stem the fall in the group's total gold production, gold production volumes continued to decline through the end of FY22. This trend was reversed in FY23 as gold production exceeded 2Moz (circa 7.5% increase on FY22), driven by higher milling throughput at Cadia and Lihir (and a full year contribution from Brucejack), as well as higher gold head grade at Lihir and Brucejack.

Historical Financial Performance

The financial performance of Newcrest for FY20 to FY23 is summarised below:

NEWCREST - FINANCIAL PERFORMANCE (\$ MILLIONS)

	FY20 ACTUAL	FY21 ACTUAL	FY22 ACTUAL	FY23 ACTUAL
Gold produced (koz) ¹¹	2,171	2,093	1,956	2,105
Gold sold (koz) ¹¹	2,143	2,116	1,917	2,114
Average realised price – gold (per oz)	\$1,530	\$1,796	\$1,797	\$1,797
Copper produced (kt) ¹¹	138	143	121	133
Copper sold (kt) ¹¹	137	141	119	136
Average realised price – copper (per lb)	\$2.57	\$3.66	\$4.36	\$3.76
AISC (per oz)	\$862	\$911	\$1,043	\$1,093
Total revenue	3,922	4,576	4,207	4,508
EBITDA	1,872	2,417	2,009	2,044
Share of profit/(loss) of associates	(37)	26	45	19
Reported EBITDA¹²	1,835	2,443	2,054	2,063
Depreciation and amortisation	(644)	(673)	(750)	(891)
Reported EBIT¹²	1,191	1,770	1,304	1,172
Net interest expense	(171)	(102)	(75)	(96)
Significant expenses (pre-tax)	(35)	-	-	-
Income tax expense	(350)	(504)	(357)	(298)
Non-controlling interest	12	-	-	-
NPAT attributable to Newcrest shareholders	647	1,164	872	778
STATISTICS				
Basic EPS	83.4c	142.5c	103.4c	87.0c
DPS	25.0c	55.0c	27.5c	55.0c
Dividend payout ratio	30%	39%	27%	63%
Amount of dividend franked	100%	100%	100%	100%
Total revenue growth	+4.8%	+16.7%	(8.1)%	+7.2%
EBITDA growth	+10.9%	+29.1%	(16.9)%	+1.7%
EBITDA margin	48%	53%	48%	45%
Effective tax rate	36%	30%	29%	28%
Interest cover	7.2x	17.1x	16.8x	12.0x

Source: Newcrest and Grant Samuel analysis

Newcrest's current financial performance primarily reflects the underlying operating performance of its key assets (Cadia and Lihir), its capital management strategy and the impact of movements in the gold and copper prices over the period. The historical financial performance has not been adjusted for divestments (e.g. Gosowong), acquisitions (e.g. Red Chris and Brucejack) or investments in Lundin Gold (including subsequent increases in its equity interest).

¹¹ Includes Newcrest's attributable share of Fruta del Norte through its 32% equity interest in Lundin.

¹² Reported EBITDA and reported EBIT include share of net profit/(loss) of associates and are included in the table as this is consistent with the basis on which Newcrest reports EBITDA and EBIT.

GRANT SAMUEL



In summary:

- Cadia and Lihir have historically been the largest drivers of Newcrest's financial performance. In aggregate, these two mines have accounted for 70-80% of group revenue and 80-90% of group EBITDA (excluding corporate costs) in each of the years since FY20. Cadia is Newcrest's most profitable mine and contributed an outsized share of the group's EBITDA (accounting for around 65% of EBITDA since FY20 despite contributing only 44% of revenue);
- the volatility of Newcrest's revenue reflects:
 - gold production volumes, which trended downwards despite contributions from newly acquired assets (Red Chris and Brucejack). Reduced production at Cadia (by approximately 250koz) and at Lihir (by around 100koz) were large drivers for this fall; and
 - gold and copper prices, which rose to historically high levels over the past two years (realised copper prices increased by approximately 70% between FY20 and FY22).

Despite the improvement in copper and gold production in FY23, the retreat in realised copper prices, and to a lesser extent realised gold prices, over the year has dampened the rebound in group revenue; and

- cash costs for the group have increased by over 25% over the period due to the lower production volumes, higher costs consistent with inflationary pressures experienced by the gold production industry (i.e. energy prices and labour costs) and the economy more generally. The rising cost pressures more than offset the impact of higher realised prices of copper (which are considered by-products and accounted for as "negative costs" to AISC) over the period.

Accordingly, EBITDA margins have fluctuated between 45% and 53% since FY20.

The operating performance of each of Newcrest's assets is discussed in Appendix 2.

Share of profits and losses of associates are primarily in relation to Newcrest's investment in Lundin Gold, which owns the Fruta del Norte mine. Following the mine's commissioning in 2019, Newcrest's share of profits has ramped up accordingly.

The effective tax rate is broadly in line with the Australian corporate tax rate of 30% but can be impacted by a number of factors including the recognition and derecognition of deferred tax balances, non-taxable gains and losses from equity accounted investments, the impact of lower tax rates (below 30%) for some jurisdictions in which Newcrest operates and one-off significant items such as write down of assets.

Outlook

Newcrest has not publicly released earnings forecasts for FY24. However, in conjunction with the release of its FY23 results on 11 August 2023, Newcrest provided the following FY24 guidance¹³:

- 2,000-2,300koz of gold production;
- 120-140kt of copper production;
- AISC of \$2,200-2,600 million (including sustaining capital expenditure);
- \$1,170-1,375 million of total capital expenditure (including production stripping), which includes \$610-735 million of non-sustaining and major projects capital expenditure and \$560-640 million for sustaining capital expenditure;
- exploration expenditure of \$130-150 million; and
- depreciation and amortisation of \$820-870 million.

¹³ FY24 guidance has been prepared on a standalone basis. If the Scheme is implemented, Newmont will assume control of Newcrest and the guidance provided will not apply.

Annexure 1. Independent Expert's Report

GRANT SAMUEL



Newcrest does not provide guidance in relation to total revenue or earnings. In the absence of publicly released detailed earnings forecasts for FY24, Grant Samuel has considered brokers' forecasts for Newcrest (see Appendix 4). While these forecasts are sensitive to assumptions as to future gold and copper prices and exchange rates, they provide an indication of the expected future financial performance of Newcrest:

NEWCREST – FINANCIAL PERFORMANCE (\$ MILLIONS)

	FY23 ACTUAL	FY24 BROKER CONSENSUS (MEDIAN)
Total revenue	4,508	4,720
EBITDA	2,044	2,224

Source: Grant Samuel analysis (see Appendix 4)

The median forecasts are sufficiently close to the FY24 Budget to be useful for analytical purposes.

3.3 Financial Position

Overview

The financial position of Newcrest at 30 June 2023 is summarised below:

NEWCREST - FINANCIAL POSITION (\$ MILLIONS)

	AT 30 JUNE 2023 ACTUAL
Trade and other receivables	363
Inventories (current)	615
Creditors and accruals	(693)
Net working capital	285
Property, plant and equipment (net)	12,996
Inventories (non-current)	1,116
Goodwill and intangible assets (net)	718
Investments in associates	483
Other financial assets (net)	411
Deferred tax liabilities (net)	(2,264)
Provisions	(687)
Gold price and oil hedging liability	(33)
Other assets and liabilities (net)	146
Total capital employed	13,171
Cash and cash equivalents	586
Borrowings	(1,935)
Net borrowings (excluding lease liabilities)	(1,349)
Lease liabilities	(110)
Net borrowings (including lease liabilities)	(1,459)
Net assets	11,712
STATISTICS	
Shares on issue at period end (million)	894.2
Net assets per share	\$13.10
NTA per share	\$12.29
Net borrowings (excluding lease liabilities)/EBITDA	0.7x
Gearing (including lease assets and lease liabilities)	11.1%

Source: Newcrest and Grant Samuel analysis

GRANT SAMUEL



Nearly all of Newcrest's capital is deployed in long term fixed assets such as property, plant and equipment (over 80% of capital deployed). The majority of this balance comprises capitalised mine development costs (e.g. production stripping) and on-site mining equipment and processing plant infrastructure. Capitalised exploration expenditure accounts for less than 10% of this balance.

Due to the long remaining lives and nature of Newcrest's mines, provisions for mine rehabilitation (which reflects the present value of estimated costs for dismantling and removing structures, rehabilitating mine sites, dismantling operating facilities, closure of tailings and waste sites and restoration, reclamation and revegetation of affected areas) are relatively modest.

The majority of Newcrest's inventory (more than 60%) is non-current in nature and attributable to long-term ore stockpiles (particularly at Lihir, where long term ore stockpiles are largely expected to be processed only at the end of the mine life).

Other notable items in relation to Newcrest's financial position are discussed below.

Net Borrowings

Newcrest's borrowings consist principally of long term corporate bonds and bilateral bank debt facilities:

NEWCREST – NET BORROWINGS AT 30 JUNE 2023 (\$ MILLIONS)

FACILITY	FACILITY SIZE	AMOUNT DRAWN	TERM/MATURITY
Corporate bonds	1,650	(1,650)	various (2030 to 2050)
Bilateral bank debt	2,000	(298)	June 2024 to June 2026
Capitalised borrowing costs		13	
Total interest bearing liabilities		(1,935)	
Cash and short term deposits		586	
Net borrowings (excluding lease liabilities)		(1,349)	

Source: Newcrest

The maturities of Newcrest's debt stack are spread over more than 25 years, with only the bilateral bank debt maturing within the next five years.

The bilateral bank debt comprises unsecured committed revolving facilities that were renewed in March 2021 with Newcrest's existing lenders (each of which committed approximately \$150 million in available facilities). Each of the two main tranches (three year and five year tenors) account for approximately half of the total facility size. Interest charged is variable and based on CME Term SOFR plus a credit adjustment spread plus a margin.

The corporate bonds have substantially longer tenors (up to 27 years). They predominantly comprise senior unsecured notes that were issued in May 2020 (although approximately \$500 million of the balance was issued in 2011 and 2012). Interest rates on the corporate bonds are fixed and based on coupon rates that range from 3.25% to 5.75% (or a weighted average cost of debt for corporate bonds of approximately 4.3%).

Newcrest does not use derivative financial instruments to hedge foreign exchange translation risks or interest rate risks.

Newcrest also has a number of bank guarantees in favour of various government authorities and service providers (e.g. to cover rehabilitation obligations). These guarantees are not reported as liabilities (or net borrowings) in Newcrest's accounts. The total nominal amount of these guarantees at 30 June 2023 is \$205 million.

Prior to announcement of the Newmont Transaction, Newcrest had investment grade credit ratings of BBB from S&P and Baa2 from Moody's.

Annexure 1. Independent Expert's Report

GRANT SAMUEL



Investments in Associates

As part of Newcrest's strategy, it may also make direct equity investments in other listed minerals exploration and/or production companies to secure exposure to high potential orebodies.

The most material of these investments is in Lundin Gold, in which Newcrest owns a 32% equity interest. Lundin Gold's primary listing is on the TSX. It owns the Fruta del Norte mine in southeast Ecuador.

Other associates include a:

- 10.3% interest in SolGold Plc ("SolGold"), a copper-gold exploration company with assets across Ecuador, Chile, Solomon Islands and Australia including Cascabel, its flagship copper-gold project in Ecuador. SolGold is listed on the LSE and TSX;
- 19.9% interest in Azucar Minerals Limited ("Azucar"), a mineral exploration company with tenements in Mexico. Azucar is listed on the TSX-V;
- 8.9% interest¹⁴ in Antipa Minerals Limited ("Antipa"), a mineral exploration company with tenements across the Paterson Province of Western Australia. Antipa is listed on the ASX;
- 9.9% interest in Headwater Gold Inc. ("Headwater"), a mineral exploration company with tenements in the United States. Headwater is listed on the CSE; and
- 9.5% interest in Metallic Minerals Corporation ("Metallic"), a mineral exploration company with tenements in the United States and Canada. Metallic is listed on the TSX-V.

Newcrest has the right to appoint a director to the Board of each of these associates¹⁵. Newcrest currently has two nominees on the Board of Lundin Gold. It currently does not have any nominees on the Boards of the other associates.

Other Financial Assets

The majority of Newcrest's financial assets comprise finance facilities in relation to the Fruta del Norte mine. In April 2020, Newcrest completed the acquisition of three separate finance facilities from funds affiliated with Orion Resource Partners and Blackstone Tactical Opportunities, including:

- a gold prepay credit agreement ("GPCA"), with a face value of \$150 million, payable in 19 quarterly cash payments between 31 December 2020 and 30 June 2025. The quarterly payments are based on 11,500oz of gold multiplied by the spot gold price (subject to a risk collar based on the average gold price in the preceding three month period¹⁶);
- a stream credit facility agreement ("SCFA"), with a face value of \$150 million, payable in monthly cash payments calculated as the sum of:
 - 7.75% of refined gold processed multiplied by the excess of the spot gold price over \$400/oz until 350,000oz is reached (equivalent to 4.5Moz of total gold produced); and
 - 100% of refined silver processed multiplied by the excess of spot silver price over \$4/oz until 6,000,000oz is reached.

The reference gold and silver prices are subject to an inflationary adjustment.

Lundin Gold has the option (exercisable on 30 June 2024) to reduce the monthly payment amount by 50% by paying \$150 million to Newcrest. It also has a second option (exercisable on 30 June 2026) to

¹⁴ On 28 August 2023, Antipa announced that it had received binding commitments for a placement to raise approximately \$5 million through the issue of approximately 385 million shares. The placement shares were issued on 4 September 2023. Newcrest did not participate in the placement, reducing its shareholding in Antipa from 9.9% to 8.9%. On 1 September 2023, Antipa launched a pro-rata renounceable rights issue to raise up to \$2 million through the issue of approximately 153 million shares. The rights issue is not expected to close until 28 September 2023 so its impact has not been included in calculating Newcrest's shareholding in Antipa.

¹⁵ Newcrest's right to nominate a director is subject to increasing its ownership interest in Metallic to at least 13% of outstanding shares.

¹⁶ Should the average gold price for the reference period be greater than \$1,436/oz or less than \$1,062/oz, the quarterly payment would be reduced or increased, respectively, by 15%.

GRANT SAMUEL



reduce the monthly payment by a further 50% (reducing the recurring payments to nil if the first option was also exercised) by paying \$225 million to Newcrest.

At 30 June 2023, approximately 257koz of gold (i.e. 3.4Moz of total gold produced) and 5,026koz of silver remains to be accounted for under the SCFA; and

- an offtake agreement, which allows Newcrest to acquire 50% of refined gold production (i.e. gold doré) from Fruta del Norte up to 2.5Moz at spot prices determined with reference to a quotational period.

Following the early repayment of the GPCA in January 2023, only the SCFA and offtake agreement remain in place.

Other financial assets held by Newcrest include mark-to-market balances of Newcrest's fuel forward contracts and the fair value of a power purchase agreement.

Group Hedging

Newcrest is predominantly an unhedged gold and copper producer. However, the company selectively enters into gold hedge contracts to manage cash flows from the Telfer mine, which still requires ongoing investments and mine development capital as it nears the end of current open cut and underground operations in 2025. These hedge contracts include Australian dollar zero cost collar contracts (i.e. a combination of put and call options).

The total outstanding volume and prices of gold hedged for Telfer (and for Newcrest) are Australian dollar zero cost collar for 308,755oz of gold with a floor price of A\$2,500/oz and cap price of A\$2,886/oz expiring between 1 July 2023 and 30 June 2024.

At 30 June 2023, Newcrest reported a \$24 million mark-to-market liability in relation to its outstanding gold hedges in place.

3.4 Cash Flow

Newcrest's cash flow for FY20 to FY23 is summarised below:

NEWCREST - CASH FLOW (\$ MILLIONS)

	FY20 ACTUAL	FY21 ACTUAL	FY22 ACTUAL	FY23 ACTUAL
EBITDA	1,872	2,417	2,009	2,044
Changes in working capital and other adjustments	(87)	95	(156)	(255)
Exploration expenditure written-off	64	69	76	76
Tax paid	(282)	(233)	(244)	(359)
Net finance costs paid	(96)	(46)	(5)	99
Operating cash flow	1,471	2,302	1,680	1,605
Capital expenditure	(695)	(1,119)	(1,417)	(1,166)
Acquisitions (net of cash)	(1,291)	(21)	(1,074)	(18)
Exploration and evaluation expenditure	(113)	(115)	(120)	(143)
Other investing cash flows	7	57	63	126
Free cash flow	(621)	1,104	(868)	404
Dividends paid	(177)	(240)	(372)	(477)
Proceeds from share issues	771	-	-	-
Repayment of lease principal	(27)	(32)	(43)	(49)
Other	(89)	(30)	(15)	(8)
Net cash generated/(used)¹⁷	(143)	802	(1,298)	(130)

¹⁷ Net cash generated/(used) is before cash flows related to borrowings, which are included in the opening and closing net borrowings figures that are used for reconciliation purposes.

Annexure 1. Independent Expert's Report

GRANT SAMUEL



NEWCREST - CASH FLOW (\$ MILLIONS) (CONT)

	FY20 ACTUAL	FY21 ACTUAL	FY22 ACTUAL	FY23 ACTUAL
Net cash/(borrowings) ¹⁸ – opening	(395)	(566)	238	(1,214)
Effect of exchange rates on cash	9	3	(13)	(4)
Non-cash borrowings from business acquisitions	(46)	-	(140)	-
Other non-cash movements in borrowings ¹⁹	9	(1)	(1)	(1)
Net cash/(borrowings) ¹⁸ - closing	(566)	238	(1,214)	(1,349)
STATISTICS				
Cash flow conversion	99%	107%	96%	91%
Capital expenditure as a % of EBITDA	37%	46%	71%	57%

Source: Newcrest and Grant Samuel analysis

Newcrest's strong operating cash flow profile is underpinned by the scale, maturity and low cost profiles of Cadia and Lihir. While production levels from these two assets have declined in recent years, cash flow conversion for the group has consistently remained above 90%. Over the past four years, sustaining capital expenditure (excluding production stripping) as a percentage of operating cash flow has increased from around 19% in FY20 to in excess of 25% in FY22 and FY23.

However, organic and inorganic growth investments in recent years have absorbed a large share of cash flows. Approximately \$2.5 billion in cash was spent on acquisitions over the period, particularly Fruta del Norte facilities in FY20 (\$460 million), the 70% interest in Red Chris in FY20 (\$769 million²⁰) and Brucejack in FY22 (\$1.1 billion²¹). Over \$2 billion was invested into major projects (non-sustaining), of which approximately 70% was in relation to Cadia. These demands on capital have pushed net debt to its highest levels since 2016 (albeit at still modest gearing ratios relative to Newcrest's peers).

Newcrest's dividend policy was revised upwards in February 2021 to target an annual dividend payout of 30-60% of free cash flow each year (up from 10-30% previously), subject to a minimum payout of \$0.15 per share each year. Newcrest has paid dividends well above these target ratios in FY20 and FY22 due to negative free cash flow and in FY23 due to the special dividend of \$0.20 per share that was declared in 1HY23 (reflecting the full distribution of funds received under the GPCA just after the end of the half year period).

3.5 Taxation Position

At 30 June 2023, Newcrest had carried forward income tax losses of approximately \$191 million (tax effected), of which \$160 million (tax effected) were recognised in the balance sheet. In addition, Newcrest had unrecognised Australian capital losses of \$101 million (tax effected).

At 30 June 2023, Newcrest had \$443 million of accumulated franking credits.

¹⁸ For the purposes of the cash flow, net borrowings excludes lease liabilities.

¹⁹ Other non-cash movements in borrowings is a balancing item. It primarily represents amortisation of transaction costs and the impact of foreign exchange movements on borrowings during the period.

²⁰ The payment of \$769 million represents the cash consideration paid and is shown net of debt and working capital adjustments acquired on completion.

²¹ The payment of \$1,084 million represents the net cash outflow. This has been calculated as the cash consideration paid (\$1,292 million) less cash and cash equivalent balance acquired (\$208 million).

GRANT SAMUEL



3.6 Capital Structure and Ownership

Capital Structure

The capital structure of Newcrest at the date of this report is as follows:

- 894,230,732 ordinary shares (including 2,626,117 treasury shares); and
- 2,814,919 outstanding equity incentives.

Newcrest operates three incentive arrangements, under which performance rights have been issued or granted, including:

- a long term incentive plan granting performance rights that have no dividend entitlements or voting rights. However, each performance right entitles the participant to receive one Newcrest ordinary share at a future time for nil consideration subject to achievement of performance hurdles, service conditions and vesting periods. In the event of a change of control, the Newcrest Board has the discretion to determine whether the vesting of all or some of the performance rights should be accelerated; and
- a sign-on share plan under which employees are granted performance rights, each of which entitles the participant to receive one Newcrest ordinary share at a future time for nil consideration but subject to performance and service conditions. This plan is typically offered to attract or retain certain executives or senior managers; and
- a Sharematch plan granting performance rights that have no dividend entitlements or voting rights. Each performance right entitles the participant to receive one Newcrest ordinary share at a future time for nil consideration subject to achievement of performance hurdles and satisfaction of service conditions. One Sharematch right is granted for each Newcrest share acquired as a result of the employee sacrificing a portion of their salary to purchase the shares. In the event of a change of control, the Newcrest Board has the discretion to determine whether the vesting of all or some of the performance rights should be accelerated.

These equity incentives are able to be settled by utilising the shares held by the Employee Share Trust (treasury shares) or cash settled.

Other plans offered by Newcrest do not involve the issuance of equity incentives. These plans include a short term incentive plan (under which senior executives may be entitled to a quantum based on achievement of established annual performance objectives with up to half of the incentive payment to be deferred and paid in shares and the balance in cash) and an employee share acquisition plan.

Newcrest also operates a dividend reinvestment plan which enables investors to reinvest some or all of their distributions in new ordinary shares at a price determined by the VWAP of shares traded on the ASX. The dividend reinvestment plant will not apply to the FY23 final dividend as the Newcrest Board suspended the dividend reinvestment plan from 11 August 2023.

Ownership

At 30 June 2023, there were over 80,000 registered shareholders in Newcrest. The top twenty shareholders (by fund) are estimated to represent approximately 44% of the ordinary shares on issue and are principally institutional nominee or custodian companies.

Newcrest has received notices from the following substantial shareholders:

Annexure 1. Independent Expert's Report

GRANT SAMUEL



NEWCREST – SUBSTANTIAL SHAREHOLDERS

SHAREHOLDER	DATE OF NOTICE	NUMBER OF SHARES	PERCENTAGE ²²
Blackrock, Inc. ("Blackrock")	18 August 2023	87,666,192	9.80%
Allan Gray Australia Pty Ltd ("Allan Gray")	3 May 2023	56,379,115	6.30%
State Street Corporation	29 July 2022	54,568,016	6.11%
The Vanguard Group, Inc. ("The Vanguard Group")	16 May 2023	44,763,930	5.00%

Source: IRESS, Scheme Booklet

3.7 Share Price Performance

Background

Newcrest's primary listing is on the ASX and maintains secondary listings on the TSX and PNGX and has ADRs that are traded over the counter in the United States.

While Newcrest shares are listed on multiple exchanges, the ASX is where the vast majority of trading of Newcrest shares occurs. Accordingly, this section covers only the share price performance of Newcrest shares on the ASX.

Share Price History

The following graph depicts the movement in the Newcrest share price and trading volumes since January 2019:

NEWCREST – SHARE PRICE AND TRADING VOLUME

JANUARY 2019 TO 31 AUGUST 2023



Source: IRESS

Historically, Newcrest shares have largely moved with the gold price albeit with amplified swings both to the upside and downside (reflecting greater volatility experienced by gold producers than the commodity itself). In recent years, the share price has also been impacted by the increased capital intensity of the business as Newcrest undertook a major mine expansion at Cadia and sustaining capital expenditure programs across its assets.

Newcrest shares traded across a very wide range of approximately A\$21-39 in 2019 and 2020. In each of those years, the share price traded strongly in the lead up to the release of financial year results and fell in

²² Based on shares on issue at date of lodgement of substantial shareholder notice.

GRANT SAMUEL



the months that followed as the market digested the results (this was exaggerated in FY20 by increasing gold prices in the months prior to July 2020 and subsequently retracting in the months after). Declining production (the result of declining gold grades and unplanned downtimes) dampened earnings while increased capital expenditure constrained free cash flows. Along with equity markets in general, the Newcrest share price fell sharply in early 2020 in response to increasing concerns about the impact of the COVID-19 pandemic, although the declines were reversed in subsequent months as equity markets recovered.

The large swings in share price narrowed in 2021 (with Newcrest shares generally trading in a narrower range of between A\$22 and A\$29) as poorer operating performance was offset by a buoyant gold and copper price environment that enabled Newcrest to deliver record free cash flows in FY21. Despite this performance, the share price drifted down across FY21 before rebounding in early 2022 on the back of improved operating performance, trading just under A\$29 in mid-April 2022. However, the share price fell again (and sharply) in subsequent months to around A\$15 by September 2022 as the combined impact of escalating capital cost pressures, weak gold prices and lower production continued to pressure the group's free cash flows.

Over the next six months, Newcrest share prices trended steadily upwards as gold prices recovered, closing at A\$22.45 on 3 February 2023, the last trading day prior to announcement of the receipt of the Revised Proposal. Since the announcement on 6 February 2023, Newcrest shares traded at higher levels of:

- A\$22.43-28.30 (with a VWAP of A\$24.85) through to 10 April 2023, the last trading day prior to announcement of receipt of the Further Revised Proposal; and
- A\$24.65-30.28 (with a VWAP of A\$27.41) from 11 April 2023 until 31 August 2023.

These share prices reflect the terms of the Newmont proposals as well as the movements in gold price over the period.

Liquidity

Newcrest is a liquid stock with high trading volumes. Average weekly volume over the twelve months prior to announcement of Revised Proposal represented approximately 3% of average shares on issue or annual turnover of around 143% of total average issued capital.

Relative Performance

Newcrest is an ASX 100 company and is member of various other indices including the S&P/ASX 200 Index and the S&P/ASX 200 Materials Index. However, neither of these indices is necessarily an appropriate benchmark against which to evaluate the share price performance of gold producers such as Newcrest.

A more appropriate benchmark is the NYSE Arca Gold Miners index, which is focused on the largest gold producers globally such as Newmont, Barrick Gold Corporation ("Barrick"), Agnico Eagle Mines Ltd. ("Agnico Eagle") and Newcrest (collectively accounting for nearly 35% of the index) as well as royalty streaming companies (e.g. Wheaton Precious Metals Corp and Franco-Nevada Corporation which account for around 15% of the index).

The chart below shows the relative performance of Newcrest shares against the NYSE Arca Gold Miners index and gold spot prices from 1 January 2019 (i.e. all rebased to 100):

Annexure 1. Independent Expert's Report

GRANT SAMUEL



NEWCREST VS NYSE ARCA GOLD MINERS INDEX VS GOLD SPOT PRICES

JANUARY 2019 TO 31 AUGUST 2023

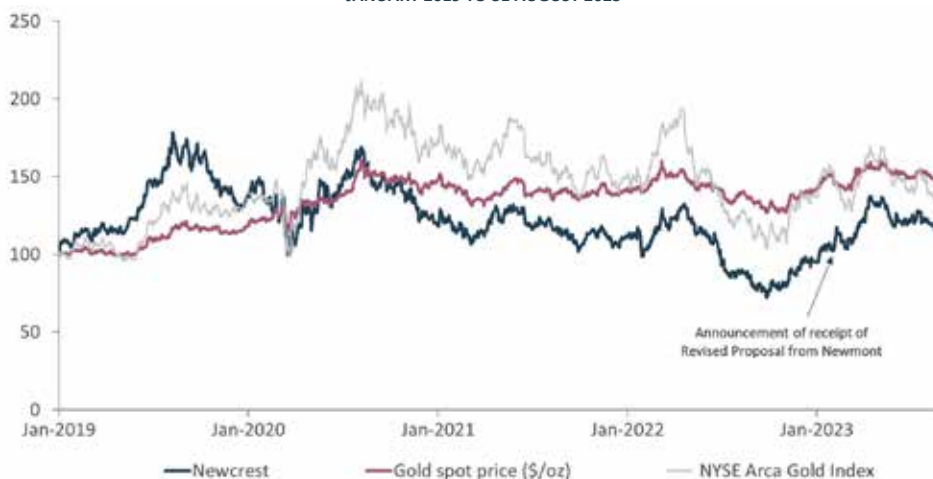

Source: IRESS and Bloomberg

The analysis shows that Newcrest shares have generally trended in line with other gold producers. However, there have also been temporary periods of dislocation (both to the upside and downside). Newcrest shares outperformed the index for the most of 2019 supported by the strong performance at Cadia and Lihir, however, this was followed by a short period of underperformance in the second quarter of 2020 due to negative sentiment surrounding COVID-19 and Australian government lockdowns. Since then, its performance has been largely in line with the index as shown below:

NEWCREST VS NYSE ARCA GOLD MINERS INDEX VS GOLD SPOT PRICES

JULY 2020 TO 31 AUGUST 2023

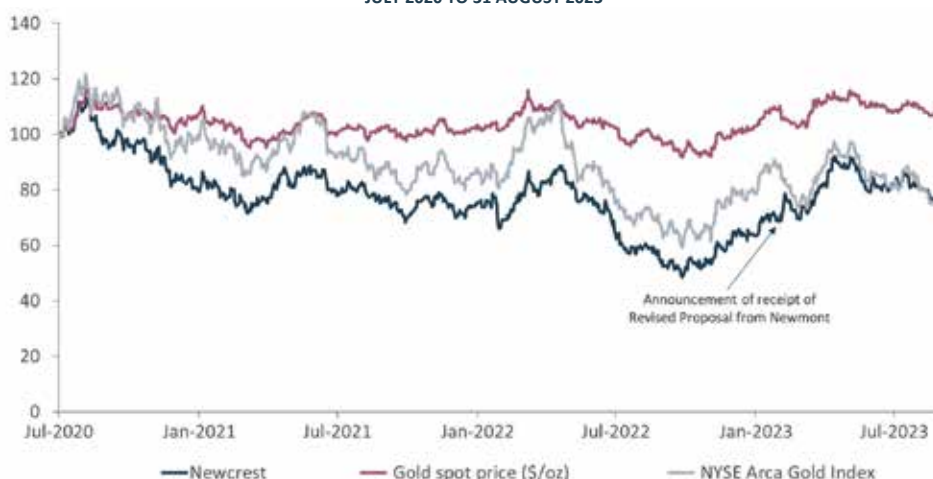

Source: IRESS and Bloomberg

While this analysis is based on the Newcrest share price denominated in US\$ (to align with the gold price and the majority of the index constituents), an analysis using A\$ would show substantially the same pattern (albeit somewhat amplified by significant A\$ weakness at the end of 2022).

GRANT SAMUEL



4 Valuation of Newcrest

4.1 Summary

Grant Samuel has valued Newcrest in the range \$16.7-18.9 billion which corresponds to a value of \$18.64-21.13 per share. The valuation is summarised below:

NEWCREST - VALUATION SUMMARY (\$ MILLIONS)

	REPORT SECTION REFERENCE	VALUE RANGE	
		LOW	HIGH
Cadia	4.3.2	7,200	8,000
Lihir	4.3.3	4,000	4,500
Telfer (including 70% interest in Havieron)	4.3.4	500	600
Red Chris (70% interest)	4.3.5	2,100	2,450
Brucejack	4.3.6	3,000	3,300
Wafi-Golpu (35% interest) ²³	4.3.7	420	525
Exploration and development	4.4	86	86
Corporate costs (net of savings)	4.5	(550)	(585)
Investment in associates	4.6	950	990
Other assets and liabilities	4.7	492	562
Enterprise value		18,198	20,428
Adjusted net borrowings at 30 June 2023	4.8	(1,531)	(1,531)
Value of equity		16,667	18,897
Shares on issue (millions) ²⁴	3.6	894	894
Value per share		\$18.64	\$21.13

The valuation represents the estimated full underlying value of Newcrest assuming 100% of the company was available to be acquired and includes a premium for control. The value exceeds the price at which, based on current market conditions, Grant Samuel would expect Newcrest shares to trade on the ASX in the absence of a takeover offer. Shares in a listed company normally trade at a discount of 15-25% to the underlying value of the company as a whole (although this discount does not always apply).

The principal approach to valuing Newcrest's mineral assets was by DCF analysis. The valuation also reflects evidence as to value from other valuation methodologies such as multiples analysis based on earnings, mineral resources, ore reserves and production as a cross check. The NPV outputs for the producing mineral assets (Cadia, Lihir, Telfer, Red Chris and Brucejack) and advanced development projects (Wafi-Golpu) were estimated based on production scenarios developed in conjunction with, and reflecting the technical judgement of, the independent technical specialist, AMC. For the purposes of the analysis, two production scenarios were developed for each producing mineral asset, with the exception of Wafi-Golpu for which only one production scenario was developed due to its current stage of development and the expected date at which production will commence (at least after 2028). Technical valuation assumptions (e.g. production and processing rates, metal grades and recovery rates, operating and capital costs and closure costs) for each scenario were reviewed in detail, and estimated, by AMC. The financial models used in the DCF analysis incorporate cash flows from 1 July 2023.

²³ The valuation approach for Wafi-Golpu takes into account the State of PNG's right to acquire up to a 30% interest in the project from Newcrest and Harmony Gold Mining Company Limited (or 15% from each joint venture participant) for a price equal to the pro-rata calculation of accumulated exploration expenditure (which is included in the value attributed to other assets and liabilities). See Section 4.3.7 for details.

²⁴ Shares on issue are Newcrest's 894,230,732 issued shares. The accelerated vesting of 2,814,919 equity incentives will be met by the existing 2,626,117 treasury shares with the shortfall (188,802 equity incentives at the date of this report) being cash settled.

Annexure 1. Independent Expert's Report

GRANT SAMUEL



The valuation of Newcrest is fundamentally dependent on Grant Samuel's judgement as to key assumptions adopted for valuation purposes, including appropriate gold and copper prices. However, future commodity prices are inherently uncertain and shareholders could reasonably form a view that different commodity price assumptions are warranted which, in turn, could lead to a different conclusion. The same considerations apply to other key assumptions such as discount rates and exchange rates.

In any event, Grant Samuel then determined an appropriate value range for each asset reflecting the NPV outcomes of the various scenarios, the evidence from other methodologies (e.g. multiples of earnings and resources) and various other factors such as location, development status, resource upside and optionality. The value is not based on any one scenario or set of assumptions.

The valuation excludes synergies that are unique to Newmont. However, it does include an allowance for synergies any acquirer of Newcrest would be able to achieve, including savings in listed company costs and other corporate overheads. These savings have been included in the negative valuation range attributed to corporate costs.

AMC prepared valuations of Newcrest's exploration and development assets for which it was not appropriate to prepare cash flow based valuations. These include:

- remnant mineral resources and ore reserves and brownfield exploration targets not mined as part of the mine plans for each of Newcrest's producing mineral assets (including those in advanced development stage, such as Wafi-Golpu);
- early stage development assets (e.g. Namosi) which are greenfield in nature and for which production schedules cannot be reliably produced at this stage; and
- greenfield exploration assets particularly in United States, Ecuador and Australia. This excludes the market value of direct investments that Newcrest has in listed equity securities which have been separately valued.

The AMC valuation of these assets is set out in its detailed report, which is included as Appendix 7 to this report. The value of remnant mineral resources and exploration projects or targets located at existing operations has been included in the value of those operations in the table above. The value attributed to exploration and development includes only assets at other locations.

Other assets include the value of investments in associates (e.g. Lundin Gold, SolGold, Antipa, Azucar, Headwater and Metallic) and the value of Fruta del Norte financing facilities. The estimated value for the investments in associates is higher than Newcrest's carrying value for these assets at 30 June 2023 of \$483 million. Newcrest's carrying value is on an equity accounted basis and represents the historical cost of the investment adjusted for profits and dividends over time. In comparison, Grant Samuel's value estimate is a judgement as to the price that an acquirer may be willing to pay for these investments by reference to the market value of listed securities and, in the case of Lundin Gold, other valuation cross checks (e.g. DCF analysis and multiples analysis).

Grant Samuel's valuation of Newcrest implies the following valuation parameters:

GRANT SAMUEL



NEWCREST – IMPLIED VALUATION PARAMETERS

	VARIABLE	RANGE OF PARAMETERS	
		LOW	HIGH
EBITDA			
FY23 (historical) (times)	\$2,044 million	8.4	9.5
FY24 (median broker forecast ²⁵) (times)	\$2,224 million	7.8	8.7
Attributable resources and reserves^{26,27}			
Gold resources (\$/oz)	126.2Moz	137	154
Gold reserves (\$/oz)	55.2Moz	312	352
Attributable gold production²⁷			
FY23 gold production (\$/oz)	1.9Moz	8,886	10,014

The overall multiples are blended multiples for Newcrest's mineral assets that reflect the nature (e.g. operating assets vs those under development) and the relative size and organic growth opportunities available to each of the mineral assets. The overall multiples are weighted towards the valuations of Cadia and Lihir but incorporate the value of future development projects such as the Red Chris block cave expansion and the Wafi-Golpu project.

The implied EBITDA multiples are towards the high end of the range of the sharemarket evidence from the listed major gold producers and the recent transaction evidence. In Grant Samuel's view, the implied multiples reflect a balancing of various factors. Newcrest has a number of attractive features, including its:

- scale and diversification, as one of the world's largest gold producers with a portfolio of high quality and long life mineral assets largely in "safe and predictable" mining jurisdictions such as Australia and Canada;
- long expected reserve life across a number of producing assets, including Cadia, Lihir and Red Chris (once the block cave expansion is completed);
- an established organic growth pipeline at a number of assets (e.g. Red Chris block cave expansion, Havieron expansion, the Wafi-Golpu project, etc.) and the balance sheet capacity to undertake and fund these opportunities; and
- expectations of a near-term earnings recovery as productivity improves across its portfolio, including at Cadia and Lihir both of which have experienced operating challenges over the last three years.

On the other hand, there are some countervailing factors:

- high asset concentration, particularly at Cadia and Lihir (where Lihir has higher sovereign risk than other mineral assets and projects in more stable jurisdictions such as Australia or Canada); and
- the substantial project execution risks (timing, cost etc) to deliver the growth pipeline, including the:
 - Red Chris block cave expansion and Havieron development project, both of which are still in feasibility study stages and have not produced ore at this stage;

²⁵ While Newcrest has provided guidance for FY24, the directors of Newcrest have decided not to include the FY24 forecast in the Scheme Booklet and therefore this information has not been disclosed in this report. Accordingly, the implied multiples are based on the median of brokers' forecasts for Newcrest (see Appendix 3 for details). These median forecasts are sufficiently close to Newcrest's FY24 Forecast to be useful for analytical purposes.

²⁶ Attributable resources and reserves assume a 35% interest in Wafi-Golpu which is consistent with the valuation approach for Wafi-Golpu. See Section 4.3.7 for further details.

²⁷ For the purposes of calculating these multiples, enterprise value, attributable resources and reserves and production exclude investments in associates (e.g. Newcrest's interest in Lundin Gold).

Annexure 1. Independent Expert's Report

GRANT SAMUEL



- Lihir's transition into the high grade Kapit zone commences with Phase 19, however full extraction of the Kapit ore is subject to the current Feasibility Study, subsequent investment decisions and execution of the seepage barrier; and
- Wafi-Golpu project, which has seen positive regulatory momentum in the past year but remains in the development stages.

Unlike the EBITDA multiples, the gold resource and reserve multiples are towards the middle of the range of the market evidence. While relatively high multiples might be justified by factors such as the quality jurisdictions of most of Newcrest's assets and the large copper endowment of some assets the multiples are moderated by the:

- long periods over which they will be extracted;
- large amount of remnant resource across Newcrest's mineral assets (adding to resource quantities but of low value); and
- upfront capital expenditure required to develop the projects and the associated development risks (particularly at Wafi-Golpu, Red Chris and, to a lesser extent, Telfer and Havieron).

In Grant Samuel's view, the implied valuation multiples, appropriately reflect the attractive characteristics and growth outlook of Newcrest balanced against its risks.

4.2 Valuation Approach

4.2.1 Overview

Grant Samuel's valuation of Newcrest has been assessed by aggregating the estimated market values of each of its mineral and other assets and deducting net external borrowings, other liabilities and corporate costs. The valuation of Newcrest's mineral assets has been estimated on the basis of fair market value, defined as the maximum price that could be realised in an open market over a reasonable period of time given current market conditions and currently available information, assuming that potential buyers have full information. Other assets have been valued on the basis of the net realisable value of those assets.

There are four primary valuation methodologies that are commonly used for valuing operating businesses (including mineral assets):

- multiples of earnings or cash flows;
- industry rules of thumb (e.g. dollars per unit of resource, reserve or production); and
- estimation of the aggregate proceeds from an orderly realisation of assets.

Each of these valuation methodologies has application in different circumstances. The primary criterion for determining which methodology is appropriate is the actual practice adopted by purchasers of the type of business involved.

Grant Samuel has adopted the DCF methodology as its primary basis for the valuation of Newcrest's mineral assets. However, application of the DCF methodology is not deterministic. The valuations of Newcrest's mineral assets represent Grant Samuel's overall judgements as to value and have been determined having regard to the sensitivity of the financial analysis to a range of technical and economic assumptions. They do not rely on any one particular scenario or set of economic assumptions and incorporate Grant Samuel's judgement as to the impact on value of factors such as location (and therefore exposure to sovereign risk), development status, resource and reserve upside and optionality to the extent not reflected in the financial analysis.



GRANT SAMUEL



Where appropriate, the valuations also take into account direct market based evidence as to the value of broadly comparable projects, assets or companies (e.g. multiples of earnings and resources and reserves) which have been used as cross-checks.

4.2.2 DCF Methodology

The DCF methodology is the dominant method of valuation in the mining industry and has been used as the primary basis for valuing the assets of Newcrest. This approach involves the calculation of NPV by discounting expected future cash flows for each mineral asset. Projected cash flows are discounted to a present value using discount rates that take into account the time value of money and risks associated with the cash flows. The DCF methodology is particularly appropriate for assets such as mineral assets where cash flows can be “lumpy” as a result of significant capital expenditure requirements (particularly for mine expansions or project developments), step-changes in production profiles or changes to mining and/or milling assumptions as mining progresses through different areas of the orebody (e.g. head grades, recoverability, etc.). Moreover, the DCF methodology allows the valuation analysis to capture the impact of limited reserve lives (which can vary across assets) as reserves are depleted over time and end of mine liabilities.

NPV outputs for the operating assets (Cadia, Lihir, Telfer (inclusive of Havieron), Red Chris and Brucejack) and for Wafi-Golpu were estimated based on valuation scenarios developed in conjunction with AMC. Grant Samuel constructed cash flow models for each of Newcrest's key mineral assets and determined the economic and financial assumptions used in the cash flow models (e.g. commodity prices, exchange rates, discount rates). AMC provided estimates of the technical assumptions, including those regarding reserve estimates, recoverability, annual production profiles, operating costs, capital costs, rehabilitation costs and the potential for reserve extensions.

Gold and copper prices, exchange rates and expectations regarding future operating parameters are fundamental to the valuation of Newcrest but it needs to be recognised that they can:

- fall in relatively wide ranges (certainly wider than those adopted in the valuation analysis). However that would result in valuation ranges that were so wide as to be of little value to shareholders in making a decision about the Newmont Transaction. Accordingly, Grant Samuel has utilised narrower ranges for its assumptions; and
- change significantly over short periods of time. Such changes can have significant impacts on underlying value.

The DCF valuations also reflect the technical judgements of AMC regarding the prospects for each of Newcrest's mineral assets. While the values estimated are believed to be appropriate for the purpose of assessing the Newmont Transaction, they may not be appropriate for other purposes or in the context of changed economic circumstances or different operational prospects for Newcrest's mineral assets.

For example, mine planning and design is fundamentally guided by long term views on the same important assumptions such as gold and copper prices, which can impact the optimisation of pit shell designs and consequently the “scope” of the orebody that will be mined. However, in practice, the exercise of mine planning and design can be resource and time intensive. While gold and copper prices may fluctuate in the short term, mines will typically follow (to a large extent) the existing mine plan and either absorb the profit hit to short term price downturns in prices or benefit from higher price environments. In some instances, production can perhaps slow down or mining in certain areas can be deferred, but in aggregate, the mine plan remains broadly unchanged. A significant refresh of the mine plan typically only happens when there is a significant change to the mining method (e.g. from open pit mining to block caving as with Red Chris) or dramatic changes to the price outlook (principally for gold and copper) that demands a fundamental reassessment.

GRANT SAMUEL



In the case of Newcrest, AMC has reviewed the current plans of the company and prepared two production cases for each mineral asset based on the identified mineral resources and ore reserves of the company and life of mine plans (including recoverability and capacity assumptions) provided by Newcrest. AMC applied its judgement and adjusted these estimates and projections as it deemed appropriate. While the gold and copper price assumptions are higher than the prevailing prices when the mine plans were set, these are not expected to result in an immediate redesign of the mine plan (i.e. by way of expanding production). Accordingly, the AMC production cases do not contemplate further additions of new mineral resources that may "become available" to be mined under the gold and copper price assumptions used in the value analysis.

4.2.3 Issues with DCF Valuation in the Gold Sector

While the DCF methodology based on discount rates derived from the Capital Asset Pricing Model is conventionally used to value mineral assets (including gold), there are significant limitations that need to be considered when applying the methodology. The most significant of these are:

- **reliability of the CAPM.** The CAPM is the most widely understood and used model for determining discount rates. It provides a theoretical basis for determining a discount rate that reflects the returns required by diversified investors in the equity of the company. CAPM is based on the assumption that investors require a premium for investing in equities (which carry risks) rather than in risk free investments. The risks relating to a company or business can be divided into either:
 - specific risks, which are specific to a particular company or business and are unrelated to movements in equity markets generally. It is assumed that diversified investors require no additional returns to compensate for specific risk, because the net effect of specific risks across a diversified portfolio will, on average, be zero; or
 - systematic risks, which cannot be diversified away as they reflect the risk that the return from an investment or business operation will vary with the market return in general.

CAPM postulates that the return required on an investment or asset can be estimated by applying to the market risk premium a measure of systematic risk described as the beta factor²⁸. The beta of an investment represents its systematic risk only. It is not a measure of the total risk of a particular investment. An investment with a beta of more than one is riskier than the market as a whole and an investment with a beta of less than one is less risky. The discount rate appropriate for an investment which involves zero systematic risk would be equal to the risk free rate.

However, it is important to recognise that the cost of equity is not a precise or provable number nor can it be estimated with any degree of reliability. The cost of equity capital is not directly observable and models such as the CAPM do no more than infer it from other data using one particular theory about the way in which security prices behave. The usefulness of any estimate therefore depends on the efficacy of the theory and the robustness of the data but the available tools such as CAPM involve:

- a model that has questionable empirical validity (i.e. it often does not explain share price movements with any reliability);
- simplifying assumptions and approximations;
- the use of historical data as a proxy for estimates of what are forward looking parameters;
- data of dubious statistical reliability; and
- unresolved issues (such as the impact of dividend imputation).

There are also myriad measurement issues in determining the cost of debt and the debt/equity mix.

²⁸ The beta for an investment reflects the covariance of the return from that investment with the return from the market as a whole. Covariance is a measure of relative volatility and correlation.

G R A N T S A M U E L



In summary, it is important not to over-engineer the process or to credit the output of models with a precision they do not warrant. It is easy to be captured by the accumulation of data and its apparent sophistication. A mechanistic application of formulae derived from theory can obscure the reality that any output from cost of capital models should be treated as a broad guide rather than an absolute truth.

- **lack of explanatory power for gold companies.** While the DCF methodology is the most frequently applied approach to valuing gold producers and gold projects, there is considerable uncertainty about the extent to which the NPV outcomes from the analysis results properly explain observed market values.

In practice, there is little consensus on:

- an appropriate basis for the valuation of gold assets. Analysts, valuers and other market commentators typically use a number of methodologies (e.g. DCF analysis and earnings or cash flow multiples) and often combine the value outcomes from the various methodologies. However, brokers apply a wide range of weighting to the value outputs from the different approaches. The value estimates determined under the DCF methodology are therefore “diluted” in the final value outcome; and
- key valuation assumptions such as discount rates and future gold prices. There is a wide diversity of discount rate assumptions made by brokers and valuers:
 - North American analysts typically use a discount rate of around 5.0% when valuing gold assets, reflecting a slight premium over risk-free rates (i.e. an implied beta greater than zero); whereas
 - Australian analysts adopt a similar methodology, but generally arrive at a slightly higher discount rate that possibly takes into account the discrepancies in capital markets as higher beta estimates for ASX-listed gold producers are more common.

Similarly, long term gold prices used by the brokers also fall across a very wide range but recently appear to generally fall in the range \$1,500-1,750/oz (as a “long term” price), which is well below spot prices observed in the current market environment. In any event, these valuations are often unclear on whether the assumptions are based on real or nominal inputs.

In addition, there appears to be some evidence that DCF analysis has poor predictive power especially when applied to gold assets. NPVs produced by broker valuations sit across a very wide range and can be well below market value of the assets observable by reference to equity market values or the price at which the assets are purchased and sold. This is particularly the case with long life gold assets. DCF analysis attributes little value to the later years of production of such long life assets.

Analysts and other gold market observers frequently refer to a “gold premium” to explain the residual difference between DCF valuations and market values. Many analysts use a price-to-NPV (or “NAV”) multiple that can range anywhere between one and three times to bridge the gap between the NPVs and the market values. There is typically no consistency in any of these multiples. The application of such premiums is not a robust approach to valuation and the wide variance in parameters is particularly unhelpful.

Moreover, it is difficult to ascertain the specific rationale for this premium over NPV:

- is it because the “true” discount rate is lower than that used in calculating the NPV (e.g. should it be the risk free rate as postulated by the gold futures methodology)?
- is it because market prices for gold and copper are higher than those assumed in the NPV analysis?
- is it because there is additional value from exploration targets and/or mineral resources that has not been adequately reflected in the DCF analysis? or

Annexure 1. Independent Expert's Report

GRANT SAMUEL



- is there a lack of information about the productive capacity of the mine (e.g. expansion projects)?

The reality is that the reason could be some or all of these (and possibly other reasons). The resultant uncertainty and diversity of approaches in the valuation of gold companies is evidenced by the very wide range of value estimates even for an established producer such as Cadia. Broker valuations range from \$5.3 billion to \$8.7 billion. These differences are accentuated even further for assets with significant forthcoming expansions such as Red Chris, for which broker valuations (on a 100% basis) sit across an even wider range from \$1.6 billion to \$3.5 billion; and

- **selecting an appropriate discount rate for gold assets.** Physical gold is unlike most other investment classes. As a “safe haven” investment class, it has historically been associated with very low (if not zero) systematic risk and, consequently, near-zero or negative betas over time. In periods of heightened market stress, investors have generally gravitated towards gold as a store of value whereas investors have generally reduced their allocation to non-income yielding assets such as gold during buoyant market environments. The limited systematic risk attached to physical gold is reflected in its near-zero beta over time as well as very low measured betas of gold producers given their direct exposure to the gold price. Hence, the low discount rates often applied to gold producers.

However, a review of the historical changes in beta estimates suggests that while measured betas were consistent with this thesis prior to 2020 (i.e. close to zero) they jumped materially after the market disruption caused by the COVID-19 pandemic and have remained at these elevated levels:

HISTORICAL ROLLING FIVE-YEAR BETA ANALYSIS - NYSE ARCA GOLD MINERS INDEX VS S&P 500

RETURN OBSERVATIONS SINCE JANUARY 2015



Source: Bloomberg

This data raises the question of whether the current measured betas of gold producers reflect:

- just a temporary bump due to COVID-19 and can be expected to revert to historical levels as the issues unwind? or
- the “new normal”, where the role of gold as an effective hedge against inflation and economic uncertainty has changed (which would accord with some market commentary on the performance of gold over the past 10-15 years)?

At this point in time, there is no clear answer.

In addition, the issues around selecting appropriate discount rates are further complicated by the substantial copper by-products typically attached to some gold assets (and especially so for some of



GRANT SAMUEL



Newcrest's assets such as Cadia, Red Chris and Wafi-Golpu). Some gold producers (or individual mines) have very little exposure to copper but others can have substantially larger exposures. There is clear evidence that the betas for gold and copper producers are very different.

While gold producers have, historically, recorded near-zero betas (at least prior to 2020), copper producers have beta factors well in excess of 1.0 (see Appendix 6). The higher betas (and consequently discount rates) may appear to be counterintuitive to the prevailing very positive environment for producers of "future-facing" metals such as copper. However, betas are a measure of the risk that the return from an investment will vary with the market return in general. The higher betas for copper producers likely reflect copper's primary use in industrial applications which tie it closely to economic activity and therefore to "market returns". Unlike gold prices, copper prices are largely determined by usage demand, supply and marginal costs.

While valuation theory may suggest valuing gold cash flows with a lower gold-based discount rate and copper cash flows with a higher copper-based discount rate, the reality is that such an exercise is impossible. They are produced from an integrated mining and processing facility where costs cannot be separately determined. It is not feasible to isolate a copper-only cash flow stream as the production of gold and copper is typically integrated and inseparable in a mining operation.

There is also no evidence that, in practice, acquirers or investors notionally separate out a copper related cash flow stream or value it differently from the gold related cash flow stream. Most analysts appear to apply a binary approach in valuing these companies — either they are a "gold company" or a "copper company". A single cost of capital is often applied across the different mineral assets based on the dominant metal in its portfolio (although a higher cost of capital could also be used for assets in higher risk jurisdictions or assets that face higher development risks). In the case of Newcrest, most brokers apply the same discount rate to all of its assets regardless of the varying individual exposures to copper (with the exception of those facing higher development risk or jurisdictional risk). The discount rate for Newcrest adopted by analysts is broadly consistent with the discount rates used for other gold producers such as Barrick and Newmont. Similarly, there is no evidence of consistently different betas for those "gold" companies with high copper exposure (albeit that non have more than 25%).

Conceptually, however, an argument could be made that mineral assets with substantial exposures to both gold and copper should be valued using a higher discount rate reflecting the higher level of systematic risks attached to the cash flows as a result of the copper exposure. This concept is particularly relevant where individual assets (rather than a company as a whole) are being valued. At the same time, the multitude of measurement issues and general reliability of CAPM based analysis suggests it would be misleading to attempt to determine precise adjustments (e.g. a finely graduated scale). At best, a broad brush approach is most appropriate.

- **dealing with sovereign risk.** Mining is a globally diversified industry with mines located in a wide variety of jurisdictions ranging from high quality (e.g. United States, Canada and Australia) to developing countries that may be challenged by weak governance, poor economies, a lack of education and skills in the workforce and logistical difficulties.

The "sovereign risks" that apply to these more challenging countries are reflected in the values at which assets located in these jurisdictions trade. However, there is no universally adopted, quantified framework for such an analysis.

The CAPM is designed to estimate the cost of equity capital in developed markets. The first issue for less developed markets is currency. For a DCF analysis in local currency, the starting point is a risk free rate in that currency. Government bonds in these markets are not necessarily risk free so the alternative is to adjust mature market bond rates for inflation differentials (assuming the Fisher effect). In this case, the issue is not relevant as the functional currency is US dollars. It is then

Annexure 1. Independent Expert's Report

GRANT SAMUEL



necessary to also consider the extent of any “country risk” premium. While it is generally acknowledged that there is additional uncertainty associated with investment in developing markets (such as political instability, economic risks (e.g. higher inflation), level of sovereign debt and probability of default, currency fluctuations and government interference (e.g. expropriation or currency controls):

- the CAPM does not explicitly allow for this additional risk. It is not simply a case of changing the inputs to reflect risk free rates and market risk premiums in the relevant developing market, not least because of their questionable reliability;
- there is no consensus among academics or practitioners as to the best approach to estimating the equity cost of capital for companies operating in developing countries. There are several approaches (e.g. government bond spreads, credit default swap spreads, country credit ratings, relative volatility of equity market returns) but there are limitations with each approach. Widely referenced calculations such as those by Damodaran²⁹, whose latest estimate for Papua New Guinea is an 8.3% country risk premium, have been subject to strident criticism (although it is one of the few easily accessible databases). In fact, there are arguments that no adjustment is necessary as these risks can be eliminated through diversification; and
- the effective exposure to country risk varies from business to business. A single rate as suggested by Damodaran is clearly an inadequate basis for dealing with a complex issue that depends on the particular circumstances. The term of the cash flows becomes the primary driver of the value adjustment. While time is a factor (i.e. in general, the longer the term of the cash flows, the greater the risk of adverse events) there are many other critical factors. Newcrest's Lihir mine produces gold for international export markets (with revenue earned in US dollars) and therefore virtually no exposure to the domestic economy. In fact, if the PNG currency falls, it potentially benefits from a reduction in local operating costs. In addition, miners are often major employers delivering significant economic benefits direct to local communities which provides a degree of protection. This exposure is very different to that of, for example, a company importing and selling goods to the local market (where currency and the domestic economy are critical). The primary risks facing Newcrest are distinctly different and include factors such as political instability, as well as the logistics and manpower challenges of an island location. Country risk can also change quickly as economic and market conditions change.

In any event, it is Grant Samuel's preference, where practical, to reflect these risks through a risking of the cash flows rather than by adding a premium to the discount rate (albeit that the economic effect may be similar). This is the approach that has been adopted in this report.

- **dealing with development risk.** An asset under development clearly has a much higher risk profile than a mine that is already in production at (or close to) its expected long run production levels. The issues are two-fold:
 - higher NPV variability. The NPV of a development project will always carry significantly greater risk than an equivalent developed project because the large development cost that is yet to be incurred means that swings in the operating cash flows have a much greater impact on the NPV of a project compared to the NPV of an equivalent developed asset. In other words, the systematic risk is magnified (the extent depending on the relationship between the NPV and the future capital outlay);
 - there are inevitably substantive uncertainties attached to the development itself. For example:
 - potential delays in construction and commissioning;
 - the risk of cost blowouts in the development phase;
 - uncertain geology until excavation and production occurs (e.g. head grades);

²⁹ Damodaran, Aswath, Country Risk: Determinants, Measures and Implications – The 2023 Edition (July 2023).

GRANT SAMUEL



- potential logistical challenges in achieving expected run rate production levels; and
- uncertainty over operating costs.

The first two of these risks have come into stark relief over the last 12 months. For example, IGO (Cosmos), South 32 (Hermosa), OZ Minerals (West Musgrave), Lake Resources (Kachi Brine Project) and Wesfarmers (Mt Holland) have all announced material cost increases and/or delays in flagship mineral projects

While these are “specific risks” that should be able to be dealt with through incorporating contingencies into the cash flows, it is clear that the extent of issues arising in the current environment are going well beyond normal expectations.

The CAPM does not easily deal with these development issues. There is no robust evidentiary base that demonstrates with any meaningful or measurable precision:

- that listed companies primarily owning development assets have higher betas than comparable companies owning similar producing assets; and
- that a specific risk premium can be determined for development risks particularly given that the nature and extent of risks can vary substantially across different individual projects.

In summary, there are many layers of complexity and uncertainty in applying the DCF methodology. While DCF still remains a very useful tool (or at worst, a worthwhile starting point) in assessing the value of gold assets, there are a number of highly subjective judgments to apply which can have material impacts on value.

4.2.4 Valuation Cross-Checks

Alternative valuation methodologies have been considered as secondary evidence of the value of Newcrest's mineral assets. These alternative approaches to valuation are useful in determining the reasonableness of estimates of value based on valuation approaches such as the DCF analysis because these estimates are typically sensitive to the assumptions adopted (e.g. gold and copper prices and exchange rates).

A common approach to the analysis involves the review of market evidence from earnings and other multiples that buyers have been willing to pay for similar businesses in the recent past and a review of the multiples at which shares in comparable listed companies trade on sharemarkets. This analysis will not always lead to an obvious conclusion of an appropriate range of multiples as there will often be a wide spread of multiples.

EBITDA (or EBIT) multiples are a widely used and referenced valuation metric. However, they have some significant shortcomings particularly for resources companies as they do not adequately reflect the impact of:

- changing grades and recoverability of the ore over time;
- step-changes in production (and earnings) due to mine expansions or other factors;
- different remaining mine lives; and
- differences in capital expenditure requirements going forward (which can be lumpy in nature).

Gold production multiples are a common industry “rule of thumb” but are arguably even more limited than EBITDA multiples as they also do not reflect the economics of the mine (i.e. profitability) or the value of by-product credits (e.g. copper or other metals) which can be a material driver of value.

There are other industry “rules of thumb” such as resource and reserve multiples that are commonly referenced by market commentators in the valuation of mineral assets and address some of these issues.

Annexure 1. Independent Expert's Report

GRANT SAMUEL



However, reliance on these alternative metrics should be treated with particular caution as they also have their own set of significant shortcomings. They do not fully reflect:

- different metal types within the ore;
- metal grades and recovery rates;
- different processing requirements that may be involved for each type of metal (e.g. some metals are only valuable if sold as a separate concentrate);
- expected mine life and annual production capacity;
- expansion opportunities (particularly in the short term) and exploration activities (e.g. scope of drilling and testing and identification of mineral resources);
- economics of the mine plan (i.e. mining methods, unit costs) which influences the cut-off grades;
- mining costs and downstream processing costs;
- sustaining capital expenditure and any future major project costs;
- quality of product such as concentrate grades and impact of penalties (although this is less of an issue in the sales of gold bullion products); and
- jurisdiction and geographic risks.

A common “fix” for the first two of these issues is to calculate the metal equivalent of the resources and reserves, under which the different metals within the resource are converted into the grade of the major metal (in Newcrest’s case, gold) to simplify the presentation of the multiple. While this approach has some merit (e.g. simple presentation of many economic grades of different metals in the terms of a single equivalent), it also makes a number of (arguably erroneous) assumptions³⁰ that further detract from the reliability of the analysis including:

- mineral cut-off grades for the primary commodity is the relevant cut-off for all minerals in the deposit;
- all minerals are 100% recoverable;
- all minerals are 100% payable;
- production rates for each mineral/commodity are consistent over the life of mine (thereby ignoring any fluctuations from the time value of money);
- production and processing costs for all minerals are equivalent; and
- individual commodity prices are based on spot prices and remain unchanged over the life of mine.

It also runs the risk of double counting. For example, a low AISC may contribute to a high gold resource/reserve multiple but the cost structure for a mine on a gold equivalent basis may be very different. In any event, the market convention appears to more commonly reference gold-only resource and reserve multiples.

Resource and reserve multiples can also be skewed by the amount of exploration and testing work completed as the identified reserves and resources are a reflection of only the work to date. Each operation will have a different reserve conversion strategy for booking resources and reserves. Some may do a full analysis at the outset while others may defer until necessary. For example:

- operators of some deposits with well-known geological characteristics that have a track record of production may only pursue additional reserve conversion or resource drilling and studies to “replenish” ore reserves that have been consumed in production (thereby not necessarily increasing

³⁰ Source: CSA Global, The Use and Abuse of Metal Equivalents, 2019.

GRANT SAMUEL



the total size of the resource base). These deposits would arguably have “understated” mineral resource and ore reserve statements as testing was limited to only what was needed; whereas

- operators of other deposits may conduct a more comprehensive study to maximise the identification of mineral resources (and ore reserves in the event they intend to mine the deposit) to help assess the scale and value potential of the deposit. These deposits would arguably have “fully baked” mineral resource and ore reserve statements as the intent was to identify as much potential resource is available in the target areas.

In addition, resource and reserve multiples are fundamentally impacted by the extent of future capital expenditure costs. Obviously, there is a difference between a fully developed and a yet to be developed asset (i.e. a project) but there can also be complications where a mining operation is about to undertake a major expansion project. It is extremely difficult (if not practically impossible) to make adjustments for these differences from publicly available data.

There is clearly no “perfect” metric that adequately addresses all of the issues and they are not a reliable basis for determining value. At best, they provide “comfort” that values are in the right “ballpark” (or require investigation to explain any variation). The market evidence can still be useful in providing benchmarks that supplement other measures and in understanding the issues that may impact value. As such, it is necessary to consider the particular attributes of the business operation or asset being valued (relative to its peers), the transaction rationale as well as the prevailing regulatory framework and economic conditions and under which the business operates. A careful assessment of these different attributes can be helpful in establishing “bookends” within which implied valuation multiples can be considered reasonable and used to help guide the boundaries (in respect of implied multiples) of the value analysis.

4.2.5 Alternative Valuation Methodologies

Gold Futures Methodology

The gold futures methodology is an alternative approach that addresses some of the limitations of the DCF methodology for valuing gold assets. This approach is premised on the commonly held view that gold is not a commodity but is rather a financial asset. Through the gold futures market, it is possible to earn returns on gold commensurate with the returns on low risk financial instruments.

The gold futures methodology involves the valuation of future gold production by reference to the gold futures market wherein:

- the present value of future gold production is estimated by discounting at rates that reflect the time value of money only (i.e. risk free rates); and
- future extraction costs (both capital and operating) are discounted to a present value using discount rates approximating risk free rates.

The use of risk free rates is consistent with a view that there is limited systematic riskiness associated with variability in production profiles or extraction costs (as expected future gold production represents a risk adjusted profile that already accounts for development, mining and related risks). Any systematic riskiness associated with the gold price is effectively reflected in the market based gold futures prices used to value future gold production.

While the gold futures methodology has been utilised by Grant Samuel in the past, there are significant challenges to its utility and predictive power in the current market environment especially for Newcrest’s mineral assets. Accordingly, Grant Samuel has considered the gold futures methodology in its analysis but, given the current limitations, has not explicitly relied on it in determining the valuation ranges for each of Newcrest’s mineral assets.

Annexure 1. Independent Expert's Report

GRANT SAMUEL



Further information on the gold futures methodology is set out in Appendix 6.

Resources Projects and Optionality

The DCF methodology implicitly assumes that the rate of output from a mining operation is pre-determined. It ignores the value inherent in management's ability to vary production and other operating parameters in reaction to changes in gold and copper prices or other circumstances. Management may change the rate of production of a mine, close or re-open the mine or in certain circumstances even abandon it. Accordingly, a mine may be regarded as an option (or series of options) over the resources it contains.

The value of management flexibility is illustrated by the example of a marginal mine, where the marginal cash production cost is equal to expected revenue. Application of the conventional DCF methodology (or gold futures methodology) would result in the estimate of a zero value for the mine. In reality, however, the mine will have some value, because management is able to reduce or cease production if marginal revenue falls below the marginal cash cost of production and to resume or increase production if gold and copper prices rise.

Similarly, the designs and long term development alternatives for many mines allow management to change operating plans in light of future gold and copper prices and operating costs. Life of mine plans frequently involve mining marginal ore, making additional cut backs or making other operational decisions at some point in the future. However, management is commonly not required to commit to such decisions at the commencement of the mining project. Firm commitments are only required much later in the project, at which time management will be able to make decisions on the basis of the gold and copper prices and other circumstances then prevailing. The mining operations as they relate to (for example) the mining of marginal ore or a final cut back may be thought of as a series of call options exercisable at the marginal mining costs to be incurred at the time. These options represent additional value not captured by the conventional DCF or gold futures methodology.

An alternative perspective is that management flexibility results in changes in gold and copper prices having an asymmetric impact on the value of a mining operation. If prices rise unexpectedly, the mine will earn greater revenue (and may be able to mine additional mineralisation not originally scheduled for production). If prices fall unexpectedly, production will be curtailed or, in the worst case, stopped. The mine will not continue, in the long term, to be operated at a cash operating loss. By contrast, deterministic valuation models implicitly assume that there is some possibility of the mine operating on a long term basis at a cash operating loss, in the same way that it implicitly assumes that the mine may earn "super profits" as a result of a persistent increase in gold and copper prices.

Grant Samuel is aware of valuation methodologies which attempt to incorporate the option value associated with management flexibility, using a combination of conventional DCF analysis and option theory. However, the application of these methodologies is impractical in the context of the complex and unpredictable nature of mining operations. In making judgments on value, Grant Samuel has given general consideration to the characteristics of the various mining operations and the value of management flexibility or underlying option value implicit in those characteristics.

4.2.6 Specific Valuation Issues for Newcrest

Valuation Date

Newcrest has been valued at 30 June 2023 and the DCF analysis has been prepared from 1 July 2023. The primary reference point for the valuation is Newcrest's balance sheet at 30 June 2023. While adjustments have been made for relevant subsequent events (e.g. the \$0.20 final FY23 dividend), no adjustments have been made for movements in other balance sheet items.



GRANT SAMUEL



Cum Dividend Valuation

Newcrest has declared or expects to pay a:

- final FY23 dividend of \$0.20 per share; and
- special dividend of \$1.10 per share.

The valuation is prepared on a cum dividend basis with respect to the special dividend (i.e. the valuation is before payment of the special dividend of \$1.10 per share), which is dependent on the Scheme being implemented but on an ex dividend basis with respect to the final FY23 dividend (i.e. the valuation is after the payment of the final FY23 dividend), which will be paid to Newcrest shareholders irrespective of whether the Scheme is implemented.

Currency

Each of Newcrest's assets has been valued in US dollars as benchmark prices for gold and other commodities (e.g. copper and silver) are denominated in US dollars. Newcrest uses US dollars as its presentation currency.

Accordingly, respective costs for each asset (e.g. direct mining costs, processing costs, general and administrative costs, etc.) that are initially denominated in local currency (e.g. Cadia and Telfer use the Australian dollar, while Red Chris and Brucejack use the Canadian dollar), have been converted into \$ to calculate \$ denominated cash flows (which are then discounted to calculate \$ NPVs).

Synergies

Normal valuation practice is to include (either implicitly or explicitly) a value for synergies that are available to multiple acquirers but to exclude synergy value that is unique to a particular acquirer.

The valuation includes savings on listed company costs and other corporate overheads that any acquirer of Newcrest would be able to achieve. At a minimum, any potential acquirer would need to offer a price for Newcrest that contemplated the value of these synergies to be competitive with any other buyer. These savings have been included in the negative value attributed to corporate costs. Other synergy benefits such as operational cost savings that are uniquely available to Newmont and, others that are less tangible (e.g. application of Newmont's Full Potential continuous improvement program) have not been included. Some of Newmont's business efficiency improvements may, in any event, already be factored into the assumptions inherent in the valuation models used to value Newcrest's asset.

It should be noted that where earnings multiples from comparable transactions represent primary valuation evidence, adding synergies to earnings or making a further multiple adjustment for synergies would potentially result in "double counting" of value as the multiples from the comparable transactions are usually based on "standalone" earnings (either reported or forecast) and the value of synergies is therefore reflected in the multiple (i.e. the transaction multiple would be lower if based on earnings including synergy benefits).

Valuation of Investments in Associates

Newcrest directly holds investments in listed companies. Due to the nature of these interests, they are considered associates of Newcrest and their carrying value is accounted for on an equity accounted basis (i.e. the carrying value represents the historical cost of the investment adjusted for profits and dividends over time).

Grant Samuel's starting point for estimating the value of a minority investment in a listed company is to use the market price of the shares on the company's primary exchange, unless there is clear evidence that the market price is not a true reflection of fair market value.

Annexure 1. Independent Expert's Report

GRANT SAMUEL



Valuation of Newcrest's investment in Lundin Gold is not straightforward.

Grant Samuel has used the market value of Lundin Gold shares as its primary methodology to estimate the value of Newcrest's investment in Lundin Gold (see Section 4.6 for further discussion), but has also considered, and used as a cross check:

- DCF analysis; and
- multiples analysis (e.g. earnings, mineral resources and ore reserves).

4.3 Valuation of Newcrest's Assets

4.3.1 Key DCF Assumptions

There are a number of economic and financial assumptions that apply across the valuation of Newcrest's mineral assets:

Commodity Prices

APPROACH

Grant Samuel has considered the following sources in determining its price assumptions for the DCF analysis:

- Consensus Economics, a monthly publication of economic and commodity forecasts that canvasses a number of investment banks, brokers and economists to consolidate consensus projections on a range of economic indicators, including commodity prices;
- specialist commodity market analysts that provide in-depth coverage of a wide range of metals and commodities, including gold and copper;
- other market commentators such as S&P Global Market Intelligence, which is a leading financial information services provider that canvasses a wide range of macroeconomic issues and industries (including metals and mining); and
- its own research on underlying supply-demand dynamics of the relevant markets. See Appendix 3 for an overview of demand, supply and price dynamics as well as other relevant issues for gold and copper markets.

Grant Samuel's selected metals price assumptions are intended solely for valuation purposes and are not predictions of future prices. Instead, they are intended to reflect the pricing assumptions real world acquirers of the assets (i.e. other industry participants) would utilise in determining the price that they are prepared to pay.

GOLD PRICES

Gold is a financial asset and often used as a means to store wealth. Demand for gold (and consequently, its price) is primarily driven by its perceived qualities as a financial investment particularly during periods of market stress or uncertainty. As a result, the gold price is not determined by supply, demand, inventory levels or marginal costs. Instead, its price behaves more like an exchange rate.

However, there is uncertainty in projecting future gold prices for the purpose of calculating expected revenue from gold mining operations. The gold price has historically demonstrated considerable volatility. Valuers and analysts use a wide variety of assumptions regarding future gold prices, including assumptions that:

G R A N T S A M U E L



- the current real spot price, expressed in US dollar terms, will continue for the foreseeable future. This assumption is defensible on the basis that the current spot price should incorporate market expectations regarding the future spot price;
- there will be real movements in gold prices. Such assumptions amount to a belief that the valuer has a better view of the gold market than the market in general;
- gold prices will be realised on the basis of actual gold producer's hedging policies. This assumption results in the use of higher gold prices for part of the output from a gold project. While it is true that actual hedge positions will add to or subtract from value, Grant Samuel is not aware of any evidence that hedging programs increase value on a prospective basis. To the contrary, there is a common market view that hedging reduces investor interest in gold stocks and destroys value; and
- all gold will be sold at prices equal to the prices currently obtainable for future delivery of gold ("futures prices"). The use of futures prices may be justified on the basis that futures prices provide a reliable indicator of the value of future gold production. However, the use of futures prices is not obviously consistent with traditional DCF methodology. The DCF methodology involves the estimation of expected future cash flows. The gold futures price is not equal to the expected future spot gold price. Use of the gold futures price will result in the estimation of "notional cash flows" that are not equal to expected actual future cash flows. Moreover, use of the gold futures price represents an adjustment in full for gold price risk. To the extent that gold price risk is a component of non-diversifiable risk, use of the gold futures price and a discount rate estimated using the conventional CAPM framework may result in an effective "double-counting" of some or all of the gold price risk.

In Grant Samuel's view, a long-term real gold price in line with the current market (i.e. the spot market) is the most appropriate assumption given its unique characteristics as a financial asset (unlike other commodities and metals). Forecasts of gold prices are not based on fundamentals of supply and demand. The gold price is determined by market sentiment which is not forecastable. In these circumstances, the current price is arguably the best forecast of the future price.

Gold traded at or around \$1,200-1,500/oz between 2017 and 2019. However, increasing economic and geopolitical uncertainty since 2020 (e.g. COVID-19 pandemic, Russia-Ukraine war, slowing economic growth) have led to a recovery in gold prices over the past three years. The gold price continued to rise despite the tightening of monetary policies across major companies (which is usually attached to a fall in the gold price due to the non-income generating nature of gold). The gold price surpassed \$2,000/oz in several instances (albeit for brief periods) but has retreated from these record price levels to around \$1,900-2,000/oz in 2023 to date as peak interest rate expectations have subsided (and new monetary stimulus was introduced by the People's Bank of China). The gold price on 30 June 2023 was approximately \$1,920/oz and on 31 August 2023 was \$1,940/oz.

Accordingly, Grant Samuel has assumed two price scenarios (both of which sit at the top end of the range of market forecasts, excluding outliers):

- the Low Case assumes a real (FY24) gold price of \$1,900/oz; and
- the High Case assumes a real (FY24) gold price of \$2,000/oz.

Annexure 1. Independent Expert's Report

GRANT SAMUEL



HISTORICAL AND FORECAST GOLD PRICES (\$/OZ)

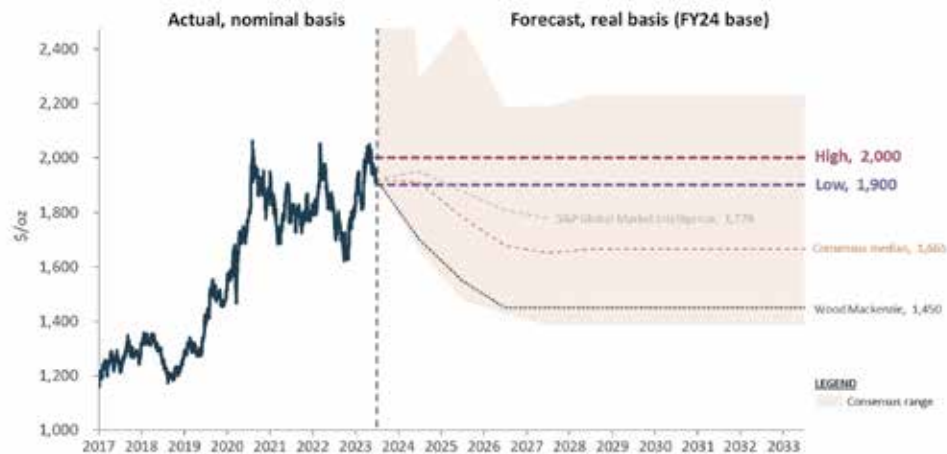

Source: Bloomberg, Consensus Economics, CRU Group (Bloomberg News, 17 April 2023), Wood Mackenzie (June 2023), S&P Global Market Intelligence

COPPER PRICES

Estimating the future trajectory of copper prices and its long term sustainable price is less straightforward:

- spot prices are inherently volatile. For example, the copper price doubled in 2020 and 2021 but then fell by 33% later in 2022. It has fluctuated across a wide range even in 2023 alone (from as high as \$9,300/t to as low as \$7,850/t). Copper prices are impacted by short term fluctuations in the day to day physical supply/demand balance (and inventories) as well as speculative trading activity. However, in the longer term, prices can be expected to reflect the fundamentals of underlying supply, demand and marginal costs;
- the underlying drivers of copper prices are multifaceted, complex and difficult to predict. While some long term trends may be clear (e.g. electrification and energy transition), the timing or pace of change is less definitive and could materially impact prices. A slower energy transition than expected should ease supply constraints and prices whereas a faster energy transition should amplify current supply constraints and prices; and
- increasing demand does not automatically result in higher prices over the long term. High prices (at least if sustained for some time) will generally elicit a number of market responses that typically lead (even if over time) to a moderation of prices including:
 - more supply with new mines opening as development is accelerated, existing mines revisiting their mine plans to take advantage of higher prices and, in some cases, previously economically marginal mines that were not profitable under less buoyant price environments re-opening;
 - increased recycling;
 - substitution, as industrial or manufacturing processes source alternative inputs that offer a similar combination of characteristics and chemical properties at potentially a lower cost; and
 - a push for technical innovation, to improve efficiencies of existing products and processes to “do more with less” with a constrained resource.

At the same time, these responses typically take some years to occur and face significant constraints and challenges (e.g. the ability to find, gain approval and fund the development of new mines).

GRANT SAMUEL



Accordingly, forecasts of long term metals prices by industry research houses, equity analysts, economists and other tend to fall in a very wide range. There is no tight consensus.

Moreover:

- a number of forecasters present “base” and “upside” cases that are materially different;
- available forecasts lag current market trading, often by some months; and
- there is no one source that is regarded as “superior” to the rest.

Taking these factors into consideration, Grant Samuel has assumed two price scenarios:

- the Low Case assumes a real (FY24) copper price of \$8,250/t; and
- the High Case assumes a real (FY24) copper price of \$8,750/t.

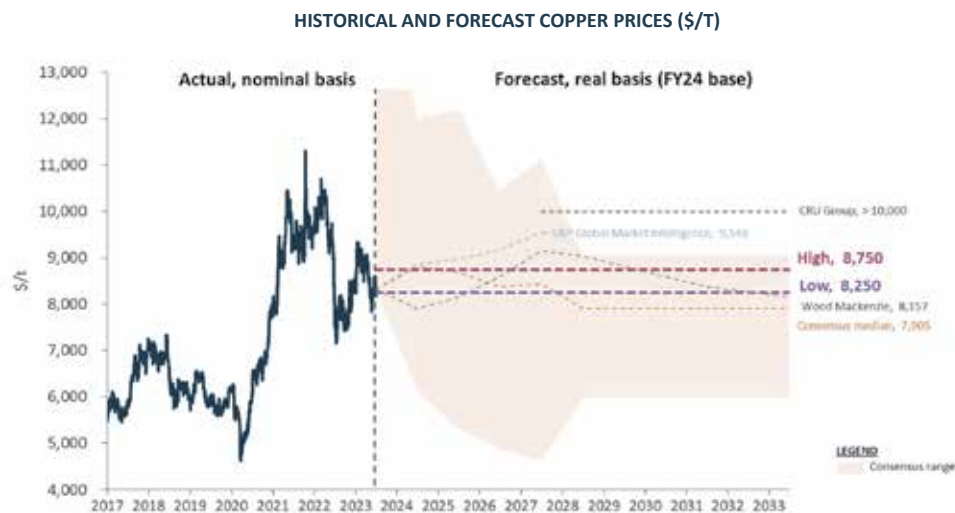

Source: Bloomberg, Consensus Economics, CRU Group (Bloomberg News, 17 April 2023), Wood Mackenzie (June 2023), S&P Global Market Intelligence

Grant Samuel's price assumption is towards the top end of the market forecasts. The price assumption was premised on the following factors:

- the copper price on 31 August 2023 was approximately \$8,400/t but has fluctuated across a very wide range in recent months (from as high as \$9,300/t to as low as \$7,850/t in 2023 alone). The volatility in the copper price reflects the global macroeconomic uncertainty, particularly in China, which has seen growth stall following the easing of COVID-19 restrictions. China has surprised the market by reintroducing monetary easing policies in an effort to bolster its economic growth. However, despite these measures, market conditions remain uncertain due to:
 - weakening global industrial demand; and
 - monetary tightening of central bank policies in most developed markets, which has resulted in a sharp increase in interest rates over the past eighteen months and for which the impact may not have yet fully permeated through local economies.

In any event, copper prices have fallen from the elevated levels seen earlier in the year (in excess of \$9,000/t) and have remained at these levels for the past two months;

- at the same time, the long term outlook for copper demand remains robust due to the tailwinds from electrification and the energy transition;

Annexure 1. Independent Expert's Report

GRANT SAMUEL



- the current copper price is close to historically high levels. It has only exceeded \$10,000/t twice in the past (in 2011-12 and in 2021-22) and then only for brief periods of time;
- price incentives are conventionally used by analysts as a “rule of thumb” for the minimum price that would encourage the development of the next marginal new greenfield project. Rising cost pressures (as a result of higher capital expenditure and more challenging geotechnical characteristics) and declining ore grades have collectively pushed price incentives higher. While there is no consensus on the appropriate incentive price, market commentators generally point towards long-term incentive prices of at least \$9,000/t (with some commodity analysts assuming long-term copper prices to exceed \$10,000/t unless the current supply-demand imbalances are adequately addressed); and
- uneconomically high prices can result in some destruction of demand for copper (and consequently place a notional ceiling on long term prices). Recent history has showed that end users have turned to other alternatives when copper prices spiked (e.g. aluminium for transmission lines). Moreover, higher prices due to the lack of available copper supply can potentially inhibit some of the primary long term demand drivers of copper (such as the adoption of electric vehicles).

Taking all of these factors into consideration, Grant Samuel believes that long term real copper prices of \$8,250-8,750/t are a reasonable basis for valuation purposes.

OTHER PRICES

Grant Samuel has assumed:

- silver price of \$22/oz (on a real basis); and
- molybdenum price of \$11.50/lb (on a real basis).

The long term assumptions for these two commodities are in line (albeit at the higher end) of the range of estimates provided by market commentators.

Inflation

The valuation model is in nominal dollars (as is the discount rate). Accordingly, an inflation factor has been applied to all forecast dollar values (including commodity prices and costs).

Grant Samuel has assumed a long term US dollar inflation rate of 2.5% (stepping down from a higher inflation rate of 3.3% in FY24). The long term rate is above the United States Federal Reserve's target of 2% but:

- it is broadly consistent with the 10 year inflation rate implied by the pricing of US inflation adjusted treasury bonds; and
- it is not unreasonable to assume that with the inflation “genie” now out of the bottle it will be challenging to return to the lows of the pre pandemic era, particularly as household expenditure continues to move towards services over goods and wages inflation (which has been largely absent for the last decade) works its way into the system.

Newcrest's costs for its Australian and Canadian assets were prepared in local currency. These costs are assumed to grow at long-term inflation rates of 2.5% (but with elevated levels in FY24).

Exchange Rates

A flat nominal exchange rate has been assumed for the duration of the valuation models of:

- A\$1.00 = \$0.67, broadly consistent with the current and recent spot exchange rates; and
- C\$1.00 = \$0.75, broadly consistent with the current spot exchange rate.

GRANT SAMUEL



The flat exchange rate assumptions are supported by the broadly similar long term inflation outlooks in all three countries.

These exchange rates have been used to translate the future operating costs and capital expenditure for the Australian and Canadian mineral assets of Newcrest. The functional currency used by Newcrest for the assets in Papua New Guinea (as well as by Lundin Gold for Ecuador) is \$ and therefore no currency conversion was required.

Tax Depreciation

Tax depreciation schedules have been determined on the basis of tax written down values for various asset categories. Accumulated carry forward expenditure deductible for tax purposes has been allowed for in the financial models.

Discount Rate

Grant Samuel has adopted a lower nominal discount rate range for valuing assets that are primarily gold-only and a higher nominal discount rate range for valuing assets that have large copper exposures. In Grant Samuel's view, this approach recognises the genuine issues with the DCF methodology in valuing gold assets with large copper exposures (see Section 4.2.3) without attempting to over-engineer the analysis to a level of precision that is not warranted.

The rates selected are:

- 6.5-7.5% for Lihir, Telfer (inclusive of Havieron) and Brucejack; and
- 8-9% for Cadia, Red Chris and Wafi-Golpu (which each have circa 50% or more revenue derived from copper).

The selected rate for Cadia, Red Chris and Wafi-Golpu is approximately midway between the rates suggested by the market evidence for gold assets (6.5-7.5%) and the rates suggested by market evidence for copper producers (9.5-11.0%). Further information on the calculation of the discount rate is set out in Appendix 6.

Risks such as sovereign risk (in relation to Lihir and Wafi-Golpu) and development risks (in relation to Telfer (inclusive of Havieron), Red Chris and Wafi-Golpu) have been taken into account by applying a discount to the NPV outputs calculated using the discount rates above. While these discounts are inherently subjective, Grant Samuel believes it at least allows an explicit consideration of the relevant factors for each asset.

Other

Other operational and specific assumptions used in the DCF models are set out in the relevant valuation sections.

4.3.2 Cadia

Summary

Grant Samuel has valued Cadia in the range \$7,200-8,000 million. The valuation incorporates the value of Newcrest's interest in Cadia and surrounding mineral resources and exploration targets.

Scenarios and Assumptions

The valuation of Cadia's core operations is based on production scenarios developed by AMC. The valuation assumptions are summarised below (all costs are presented on a real FY23 basis).

Annexure 1. Independent Expert's Report

GRANT SAMUEL



SCENARIO 1

Scenario 1 assumes the following:

- total ore production of approximately 876Mt over the life of mine (around 73% of ore reserves at Cadia East), comprising production from:
 - existing PC1 and PC2 mining areas (112Mt ore). The ore reserves from both panel caves are assumed to be depleted by FY29;
 - new PC2-3 development (122Mt ore) from FY23 to FY36, producing average gold head grades of 0.35g/t (and average copper grades of 0.44%). Production ramps up to 15Mtpa by FY27 and remain at those levels before gradually stepping down over the last six years of production through to depletion by FY36;
 - new PC1-2 development (270Mt ore) from FY26 to FY43, producing average gold head grades of 0.51g/t (and average copper grades of 0.28%). Production ramps up to 24Mtpa by FY32, remaining at those levels before gradually stepping down over the last six years of production through to depletion by FY43; and
 - six additional panel caves (370Mt ore) that will be developed sequentially over the remainder of Cadia's mine life (with the first panel cave assumed to draw first ore in FY32).

Gold and copper head grades fluctuate over the projected mine life but average around 0.46 g/t and 0.31% (slightly higher than the remaining ore reserves at Cadia East);

- ore milled broadly mirrors ore production (except for the depletion of existing stockpiles) in each year, remaining consistently around the nameplate capacity of 35Mtpa until milling operations begin winding down in FY46 (ultimately ceasing operations in FY50). Recovery rates for gold and copper average around 80-82% and 86-88%, respectively.

As a result, average gold production is approximately 390koz per annum (10.5Moz over the mine life) and average copper production is approximately 90kt per annum (2.4Mt over the mine life). Molybdenum and silver by-products are also produced at Cadia but account for only 4% of revenue per year;

- cash operating costs of approximately \$13/t of milled ore over the project life, reflecting the:
 - low mining costs attached to the bulk operating scale of a panel caving mining operation (albeit with a slight increase in unit mining costs from FY38 onwards as the mining sequence progresses towards smaller and lower grade panel caves (e.g. PC2-4, PC2-5 and PC1-4); and
 - improved unit mill cost profile following the recent investments to debottleneck the plant and expand capacity;
- other costs including state royalties (circa 3% of revenue), treatment and refinery charges, penalties and cash rehabilitation costs (assumed to be approximately \$215 million, all of which is incurred at the end of the mine life);
- capital expenditure of approximately \$4.7 billion over the mine life including growth investments in relation to:
 - the construction of PC1-2 and PC2-3 (approximately \$900 million through FY28);
 - the development of seven additional panel caves (approximately \$1.5 billion, of which nearly \$1.0 billion is incurred between FY29 and FY38); and
 - the construction of additional tailings storage capacity (nearly \$700 million between FY27 and FY30).

Sustaining capital requirements are assumed to be approximately \$60 million per annum over the mine life;





GRANT SAMUEL



- the dust issue currently affecting Cadia can be dealt with:
 - by temporarily decreasing mine production but substituting stockpile processing for a limited period at minimal overall impact;
 - a small increase in sustaining capital expenditure over the next two years (to cover permanent dust collectors underground) which has been added to the DCF analysis; and
 - a broader capital expenditure program over the next two years with the sum covered within the discretionary expenditure already allowed for in the DCF analysis; and
- income tax rate of 30% (the Australian corporate tax rate).

SCENARIO 2

Scenario 2 is based on Scenario 1 but represents an upside case with recovery rates approximately 1% higher over the life of mine. As a result, total gold and copper production increases by 93koz and 13kt over the life of mine. Cash operating costs are approximately 8% lower over the project life (primarily due to improved productivity).

The following chart shows the ore volumes assumed to be produced from Cadia as well as the expected gold and copper in each year:

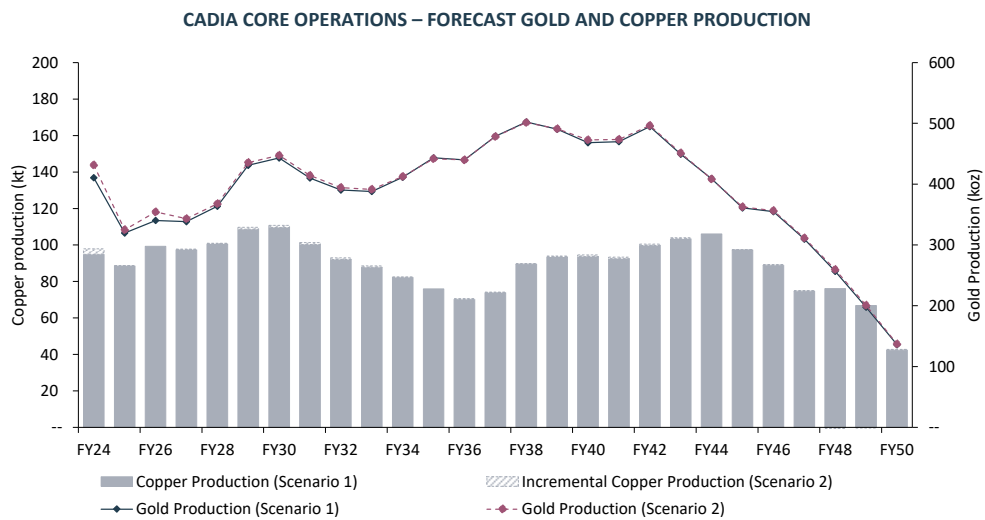

Source: AMC analysis

DCF Outputs and Valuation

The following table summarises the projected production and costs:

CADIA CORE OPERATIONS – MODEL PARAMETERS

	UNIT	FY24	FY25	FY26	FY27	FY28	LIFE OF MINE
Scenario 1							
Ore mined	Mt	34	32	33	34	33	876
Ore milled	Mt	35	35	36	35	34	895
Gold grade	g/t	0.46	0.37	0.37	0.39	0.42	0.46
Copper grade	%	0.32	0.30	0.32	0.32	0.34	0.31

Annexure 1. Independent Expert's Report

GRANT SAMUEL



CADIA CORE OPERATIONS – MODEL PARAMETERS (CONT)

	UNIT	FY24	FY25	FY26	FY27	FY28	LIFE OF MINE
Production							
Gold	koz	411	320	340	338	364	10,507
Copper	kt	95	88	99	97	101	2,405
Cash costs (real FY23 basis)	\$/t milled ore	13.7	13.3	12.2	12.1	12.3	13.1
Capital expenditure (real FY23 basis)	\$ millions	454	344	286	398	318	4,642
Scenario 2							
Ore mined	Mt	35	34	35	35	34	893
Ore milled	Mt	35	35	36	35	34	895
Gold grade	g/t	0.48	0.37	0.39	0.39	0.42	0.46
Copper grade	%	0.33	0.30	0.32	0.32	0.34	0.31
Production							
Gold	koz	431	325	354	343	368	10,600
Copper	kt	98	89	99	98	101	2,418
Cash costs (real FY23 basis)	\$/t milled ore	13.1	12.7	11.6	11.2	11.4	12.0
Capital expenditure (real FY23 basis)	\$ millions	454	344	286	398	318	4,642

The following chart aggregates the NPV outcomes for Cadia together with the value attributed by AMC to any remnant resource and exploration targets (a total of approximately \$401 million in Scenario 1 and \$526 million in Scenario 2):

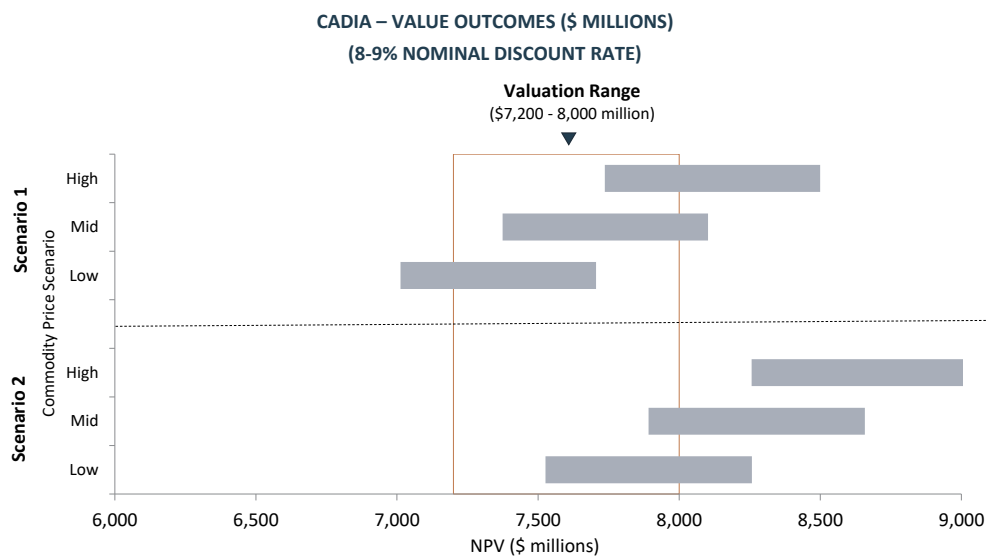

Grant Samuel's valuation range of \$7,200-8,000 million takes into account the value outcomes set out above. The high degree of overlap between the value outcomes for Scenario 1 and Scenario 2 reflects the:

- operating track record of the mine. Cadia has been in operation for over 25 years and, during that time, has successfully developed and mined a series of deposits (e.g. Cadia Hill and Ridgeway) as well as panel caves within the Cadia East deposit (including two additional panel caves that are currently under development). The asset is well understood and tightly defined; and
- limited growth profile for the asset. While there is some opportunity to ramp up ROM ore production, the processing plant was only upgraded to 35Mtpa in 2022. There are constraints that would prevent

GRANT SAMUEL



production capacity to be upgraded beyond current levels (e.g. water rights, tailings capacity). In any event, any further upgrades will inevitably involve additional regulatory approvals or permits to proceed (and there is no guarantee that these would be secured). Accordingly, there is limited opportunity to accelerate (or increase) gold and copper production rates.

The valuation range includes only the middle of the range of the value outcomes of Scenario 1 and the bottom half of the range of value outcomes for Scenario 2 as:

- there are development risks in relation to:
 - completion and ramp-up of PC2-3 and PC1-2; and
 - the subsequent development of new panel caves in succession.

For many years, two large scale panel caves (i.e. PC1 and PC2) have sustained ore production at Cadia and will be succeeded by two similarly large panel caves that will also operate in parallel (i.e. PC2-3 and PC1-2). However, subsequent panel caves will inevitably become smaller in scale as mining progresses towards less favourable sections of the orebody. More panel caves will need to be developed and operate in parallel (up to four at a given time) in order to maintain plant feed requirements (at 35Mtpa).

Successfully developing each of these panel caves and ramping up production in a timely manner (and on budget) is achievable but challenging;

- there are geotechnical risks, particularly in relation to stress building as the panel caves are developed and the supporting rock underneath the surface rock is progressively removed or mined. Addressing any issues may impact mine production rates and result in some years of reduced productivity. While detailed geological modelling and proactive measures to initiate stress release can alleviate some of these issues (which Newcrest has undertaken in the past), these risks can only be properly ascertained once mine development is sufficiently advanced or once production is already on foot; and
- the current gold price is close to the bottom of the \$1,900-2,000/oz range used in the DCF analysis so more weight is put on the Low commodity price Scenario.

Balancing all of the above factors, Grant Samuel has selected a valuation range for Cadia (inclusive of the value of remnant mineral resources and exploration) of \$7,200-8,000 million.

Valuation Cross Checks

The valuation range for Cadia implies the following valuation parameters:

CADIA – IMPLIED VALUATION PARAMETERS

	VARIABLE	IMPLIED MULTIPLE	
		LOW	HIGH
Valuation range (\$ millions)		7,200	8,000
Operating metrics			
FY23 EBITDA (actual) (times)	\$1,306 million	5.5	6.1
FY23 gold production (actual) (\$/oz)	597koz	12,060	13,400
Resources and reserves			
Gold resources (\$/oz)	36.7Moz	196	218
Gold reserves (\$/oz)	17.4Moz	414	460

While there are no directly comparable listed companies or transactions for Cadia, the implied multiples (particularly for EBITDA) appear to be reasonable and broadly supported by the market evidence of around:

- 7-8.5 times historical EBITDA and 6-8 times forecast EBITDA for comparable transactions; and

Annexure 1. Independent Expert's Report

GRANT SAMUEL



- 5.5-7.0 times historical and forecast EBITDA for listed gold producers.

The implied EBITDA multiples for Cadia are towards the middle-to-bottom half of listed company multiples and implied transaction multiples. In some respects, this relativity may be surprising given Cadia's attractive attributes including its:

- scale and track record, as it is amongst the largest gold mines in the world and the second largest gold mine in Australia (by gold production);
- long remaining mine life, with existing ore reserves expected to underpin production through at least 2050 (and further if the reserves outside the mining plan are included and additional resources are successfully converted to ore reserves in the future); and
- supportive and established regulatory environment. Australia is widely considered one of the best mining jurisdictions in the world.

However, the EBITDA multiples for Cadia also reflect the constraints to its growth. The Cadia East orebody is amongst the largest in the world. There are undoubtedly potential alternate methods or mine plans that increase mining rates and steepen the production growth trajectory for the mine. However, production is constrained by the plant capacity, water availability and limitations on tailings disposal. Following the recent completion of the plant expansion (to 35Mtpa), there are no current plans to expand plant capacity further (and consequently limited upside to production growth).

The implied EBITDA multiples for Cadia reflect a balancing of these issues.

On the other hand, the implied multiples of gold resources and reserves are at the top end of the listed peers and the transaction evidence due to Cadia's large exposure to copper (approximately 50% of future revenue) which substantially reduces the gold production cost profile of the mine (by acting as a negative cost). Very few peers have a similarly large copper endowment as Cadia. As the multiples are based solely on the gold in resource and reserves, the cash flows attributable to the copper sales are captured in the value of Cadia but not in the denominator. This factor more than compensates for the extent of resources in remnant resource (i.e. unmined in the mine plan).

4.3.3 Lihir

Summary

Grant Samuel has valued Lihir in the range \$4,000-4,500 million. The valuation incorporates the value of Newcrest's interest in Lihir and surrounding mineral resources and exploration targets.

Scenarios and Assumptions

The valuation of Lihir's core operations is based on production scenarios developed by AMC. The valuation assumptions are summarised below (all costs are presented on a real FY23 basis).

SCENARIO 1

Scenario 1 assumes the following:

- total ex-pit material movements of 593Mt (at an average strip ratio of 1.62 or approximately 75% of total ore reserves). Ex-pit mining rates ramp up to 55Mtpa in FY24 and are sustained at that level through FY26 (albeit at higher strip ratios in excess of 2.5) as mining progresses from the Leinetz zone through a high waste environment before it can access the higher grade Kapit zone. The elevated strip ratios are partly mitigated by mining at Phase 14A over the same period (approximately 20Mt of or mined at very low strip ratios of around 0.72).



GRANT SAMUEL



Mining rates step down in subsequent years to a range of 40-50Mtpa between FY27 and FY32 before gradually stepping down over the remaining mine life (ultimately ceasing mining operations in FY42);

- total ore milled of approximately 300Mt over the project life. Milling throughput averages around 12.5Mtpa between FY24 and FY27 (consistent with historical levels) and improves to 13 Mtpa by FY28 following productivity improvements and improved ore feed characteristics from the Kapit zone.

Milling throughput rates are substantially lower than the ore mining rate. Accordingly, the ore stockpile grows by nearly 60Mt through to FY32 before it is depleted over the remaining project life. The ore stockpile allows Lihir to implement its “elevated cut-off strategy” and prioritise higher grade ore. Head grades reach peak levels between FY26 to FY30 as higher grade ore from Phase 14A and Kapit zone (up to 3.5 g/t) are milled but progressively decline over the remaining mine life (average head grade of 2.2 g/t).

Recovery rates remain at around 77% through to FY27 before improving to 80-82% over the remaining life as recovery uplifts from efficiency initiatives (e.g. front end recovery project) take effect.

As a result of the increases in milling throughput rates and recovery rates as well as the substantial improvements (and subsequent decline) of head grades, gold production totals 17.3Moz over the life of mine and can broadly be categorised in three phases:

- from FY24 to FY27, ramp-up from around 780koz of gold to 1Moz of gold;
- from FY28 to FY31, consistent delivery of more than 1Moz of gold; and
- from FY32 to FY47, gradual decline of gold production (approximately 40koz per annum) as mining operations ramp down and conclude in FY42 and remaining stockpile ore is processed for an additional five years;
- cash operating costs of approximately \$55/t of milled ore over the project life, reflecting the high material handling and ore reclaim costs and legacy inefficiencies at the processing plant, which is not expected to operate at full capacity. Cash operating costs decline over the life of mine as mining transitions to less challenging (i.e. less argillic) areas of the mine such as Kapit and milling throughput improves;
- state royalties and production levies (collectively approximately 2.5% of revenue). State royalties are subsequently distributed by the State of PNG to the landowners, local government and provincial government under the terms of Lihir’s memorandum of agreement;
- other costs including refinery charges and cash rehabilitation costs (assumed to be approximately \$360 million, all of which is incurred at the end of the mine life);
- total capital expenditure of \$3.4 billion. The majority of the capital spend is sustaining in nature due to the ongoing production stripping requirements. Growth capital of approximately \$400 million is incurred to develop the nearshore soil barrier (a prerequisite to accessing ore in the Kapit zone beyond Phase 19); and
- income tax rate of 30% (the Papua New Guinean corporate tax rate).

SCENARIO 2

Scenario 2 represents an upside scenario where further productivity improvements are experienced driven by successful plant maintenance programs and expenditure, as well as improved ore feed characteristics from the Kapit zone. This sees a further 10% decrease in cash operating costs over the life of mine (under \$50/t of milled ore).

Annexure 1. Independent Expert's Report

GRANT SAMUEL



Furthermore, milling throughput rates are higher than Scenario 1, albeit total ore milled is unchanged over the project life (operations cease in FY45). Milling throughput averages under 14Mtpa (below nameplate capacity) over the life of the mine but:

- averages around 12.5Mtpa between FY24 and FY28 (consistent with historical levels), before improving to approximately 14.5Mtpa by FY29;
- averages around 13.8Mtpa between FY30 and FY33, before reaching levels consistently in excess of 14.5Mtpa between FY34 and FY43 (averaging 14.5Mtpa over the period); and
- ramp down in milling throughput for the final two years of operations.

The following chart shows the total material movements at Lihir as well as the corresponding average head grades and gold production in each year and (incremental ore volumes from Scenario 2 are represented by dotted lines):

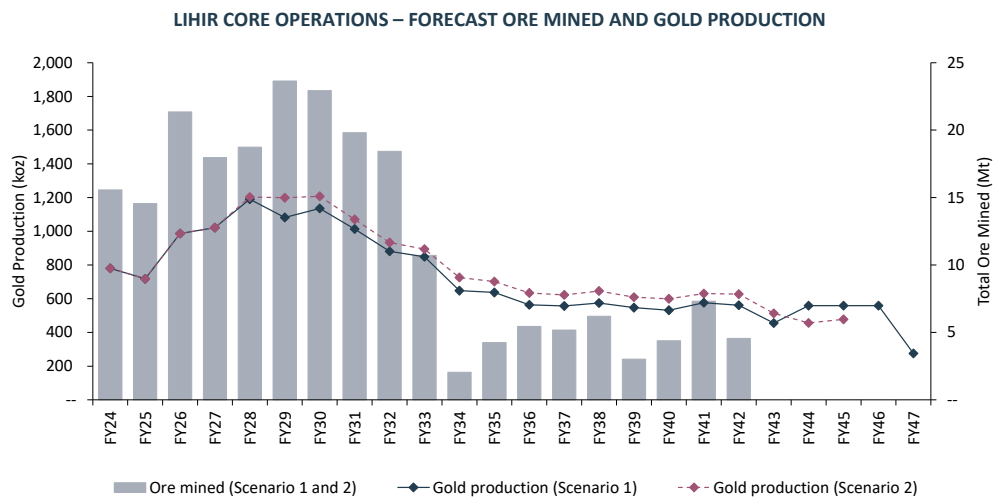

Source: AMC analysis

DCF Outputs and Valuation

The following table summarises the projected production and costs:

LIHIR CORE OPERATIONS – MODEL PARAMETERS

	UNIT	FY24	FY25	FY26	FY27	FY28	LIFE OF MINE
Scenario 1							
Waste mined	Mt	39	40	34	31	30	367
Ore mined	Mt	16	15	21	18	19	226
Total ex-pit material movements	Mt	55	55	55	49	49	593
Ore milled	Mt	12	12	12	13	13	303
Gold grade	g/t	2.53	2.36	3.18	3.27	3.55	2.21
Gold production	koz	780	718	987	1,022	1,190	17,256
Cash costs (real FY23 basis)	\$/t ore milled	75.1	71.9	69.8	66.2	65.5	54.8
Capital expenditure (real FY23 basis)	\$ millions	444	453	491	305	220	3,430

GRANT SAMUEL



LIHIR CORE OPERATIONS – MODEL PARAMETERS (CONT)

	UNIT	FY24	FY25	FY26	FY27	FY28	LIFE OF MINE
Scenario 2							
Waste mined	Mt	39	40	34	31	30	367
Ore mined	Mt	16	15	21	18	19	226
Total ex-pit material movements	Mt	55	55	55	49	49	593
Ore milled	Mt	12	12	12	13	13	303
Gold grade	g/t	2.53	2.36	3.18	3.27	3.55	2.21
Gold production	koz	780	718	987	1,022	1,203	17,256
Cash costs (real FY23 basis)	\$/t ore milled	74.3	70.4	70.5	66.1	62.2	49.3
Capital expenditure (real FY23 basis)	\$ millions	444	453	491	305	220	3,330

Grant Samuel's valuation range of \$4,000-4,500 million, inclusive of value attributed by AMC to any remnant resource and exploration targets (a total of \$221 million in Scenario 1 and Scenario 2), is at a substantial discount to the value outcomes. The value outcomes are based on the same risk free rate and discount rate range as Newcrest's other gold focussed producing mineral assets. However, it is necessary to discount such these value outcomes as they do not capture the sovereign and other risks attached to Lihir.

While Lihir has an established track record of operations and no recent issues with the State of PNG (or other levels of government, i.e. state or provincial), from the perspective of an international investor in gold companies, the mine's location is likely to make it less attractive than if it was located (for example) in Australia or Canada. Some relevant factors include:

- Papua New Guinea has a sub-investment credit rating (rated B- by S&P and B2 by Moody's) unlike Australia and Canada, both of which have a AAA rating across both rating agencies;
- recent surveys on mining and exploration companies indicate that Papua New Guinea consistently is among the least attractive jurisdictions for investment³¹ (whereas both Australia and Canada are favourably ranked); and
- estimates of country risk premium (despite its limitations) vary across a wide range but indicate a significant risk differential between Papua New Guinea (with a country risk premium of around 8%) and "safer" jurisdictions such as Australia and Canada (which have no premium)³².

Moreover, these issues are compounded by the expiry of Lihir's mining lease in 2035. Despite its track record in the country, there is no certainty that the mining lease will be renewed or (if it is renewed) will remain on the same commercial terms.

The recent challenges faced by the Porgera gold mine in renewing its mining lease offers some insight to the potential magnitude of these risks. The mine was previously jointly owned by Barrick and Zijin Mining (95% total, equally shared) and the government-owned Mineral Resources Enga entity (5%). It was one of the largest and longest running gold mines in the country with over 30 years of operating history. However, in 2020, the State of PNG elected not to extend its Special Mining Lease and, as a consequence, the mine was placed on care and maintenance.

Significant concessions were granted from Barrick and Zijin Mining to re-open the mine:

- ownership was transferred to a new joint venture, in which Barrick and Zijin Mining only held a 49% interest (previously 95%);

³¹ Source: Fraser Institute, Annual Survey of Mining Companies, 2022

³² Source: Damodaran, Aswath, Country Risk: Determinants, Measures and Implications – The 2023 Edition (July 2023).

Annexure 1. Independent Expert's Report

GRANT SAMUEL



- economic benefits generated over the life of mine were shifted, with Barrick and Zijin Mining only retaining a 47% share in the equity benefits; and
- capital requirements for the mine restart will be solely funded by Barrick and Zijin Mining (despite the reduced economic rights to the mine).

The economic cost to Barrick and Zijin Mining is unclear as there are complex arrangements in place in relation to the recovery of capital costs and taxes. Barrick stated in its Q2 conference call that its economic interest is “effectively double” the value of what the equity interest would imply.

The Porgera mine has remained in suspension for over three years although in June 2023 the project's proponents submitted an application for a Special Mining Lease to restart the mine.

While it is difficult to assess with any certainty the potential outcome for any future renewals of Lihir's Special Mining Lease beyond 2035, acquirers are likely to apply an incremental discount to cash flows beyond that period to account for the risk. A crude but illustrative approach would be to reduce all of Lihir's cash flows beyond 2035 by (say) 50% to account for this risk. This calculation results in a reduction of around \$0.9-1.1 billion for the value outcomes for Scenario 1 and Scenario 2.

The following chart illustrates the NPV and adjusted NPV outcomes for Lihir:

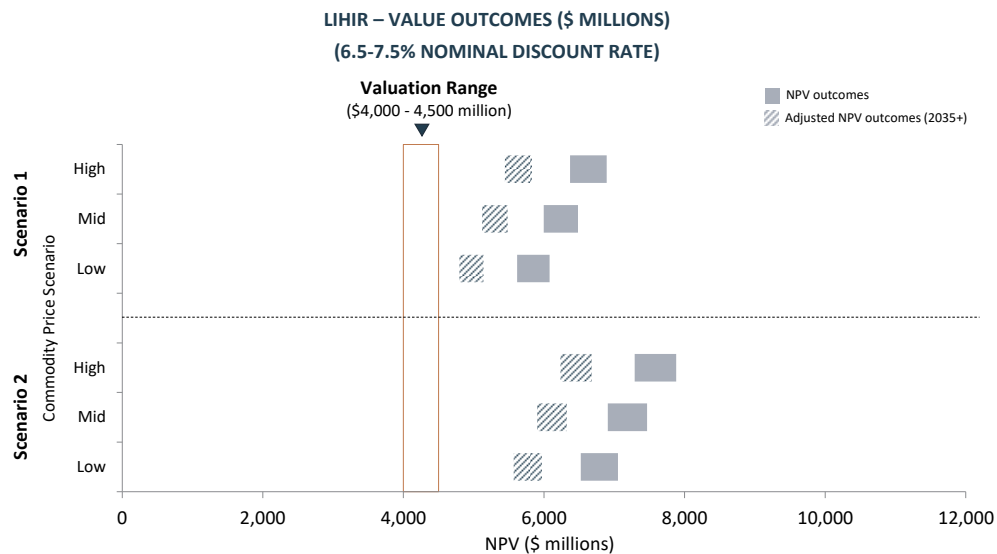

However, the adjusted NPV does not necessarily reflect the full sovereign risk adjustment that an acquirer (or investor) would apply to Lihir. In any event, it is also necessary to allow for:

- the geotechnical risks (e.g. seismic activities) and specific risks associated with its operations (e.g. power, water management, supporting infrastructure). Lihir's operating performance has historically been impacted by its challenging geothermal conditions (e.g. abnormally high ground temperatures restricted blasting in certain areas of the mine in FY20) and adverse weather conditions (from significant rainfall in FY21 to extended drought conditions in FY22 and FY23). Despite completing the MOPU project in 2013, Lihir has not produced over 1Moz of gold over a full financial year (and in fact has fallen backwards to around 700koz per annum in recent years). In a broader sense, Lihir has a long history of underperformance. While there may be sound reasons to anticipate a marked improvement going forward (which is reflected in the scenarios), any acquirer would inevitably apply a healthy degree of scepticism to such anticipated improvements. These risks are not explicitly accounted for in the production scenarios; and

GRANT SAMUEL



- environmental risks as Lihir is one of only 13 active mining operations in the world that use DSTP. Over 40 countries (including Australia and the United States) were original signatory nations to the London Protocol of 1996 that prohibited dumping of wastes into oceans and seas (becoming effective in 2006). Today, it is only used in Papua New Guinea, Philippines, Indonesia and the Turkish Black Sea. It is arguably the most logical option that balances the environmental and social concerns for tailings storage due to the terrain, rainfall and seismicity in the area. While it may be a broadly applied method in Papua New Guinea (which has three active DSTP operations and two non-operating projects/mines), it is a consideration for investors assessing value of Lihir.

Accordingly, Grant Samuel's valuation range of \$4,000-4,500 million (inclusive of the value of remnant mineral resources and exploration targets) reflects a subjective value adjustment to reflect these risks. As an alternative view, an additional risk premium of say 5% (or a discount rate range of around 11.5-12.5%) would produce NPV outcomes that are broadly aligned with Grant Samuel's valuation range.

Valuation Cross Checks

The valuation range for Lihir implies the following valuation parameters:

LIHIR – IMPLIED VALUATION PARAMETERS

	VARIABLE	IMPLIED MULTIPLE	
		LOW	HIGH
Valuation range (\$ millions)		4,000	4,500
Operating metrics			
FY23 EBITDA (actual) (times)	\$455 million	8.8	9.9
FY23 gold production (actual) (\$/oz)	670koz	5,970	6,716
Resources and reserves			
Gold resources (\$/oz)	45.3Moz	88	99
Gold reserves (\$/oz)	22.5Moz	178	200

While there is limited recent comparable transaction evidence available for gold producers in Papua New Guinea in recent years, there are several benchmarks that can be considered.

Newcrest's merger with LGL in 2010 offers a relevant value comparison (estimated at \$7.5-8.5 billion for 100% of Lihir) as well as the implied resource and reserve multiples of around \$155-175/oz and \$260-295/oz, respectively). However, numerous factors have changed over the past 13 years and any detailed multiples analysis would be of limited value. For example:

- Lihir was a much younger asset at the time (well over 30Moz of gold compared to only 18Moz today);
- operating costs are now significantly higher as a result of declining grades, operating challenges (particularly with the ageing processing plant and infrastructure) and lower recovery rates as well as inflationary cost pressures; and
- Lihir has suffered recurring performance issues especially over the last four years. Production has fallen from nearly 1Mozpa to under 700koz in FY22 and FY23.

While current gold prices (around \$1,900-2,000/oz) are substantially higher than they were in 2010 (around \$1,000-1,200/oz), the rise in prices is unlikely to fully offset the increases in costs and depletion of ore reserves at Lihir. On balance, these issues point towards a material reduction in the valuation range (as well as implied multiples) since the merger.

Grant Samuel has also examined other valuation benchmarks and believes that the multiples implied by the valuation range for Lihir are reasonable.

Annexure 1. Independent Expert's Report

GRANT SAMUEL



The implied EBITDA and production multiples are higher than the implied multiples for Cadia as well as the implied multiples for other gold producers exposed to jurisdictions deemed to “more risky” such as AngloGold Ashanti, Kinross and Gold Fields (which trade at around 5-7 times historical EBITDA and 5-6 times forecast EBITDA). In Grant Samuel’s view, the relatively high EBITDA and production multiples can be justified based on the following factors:

- the earnings upside potential at Lihir, which is expected to ramp up gold production from FY26 by over 40% compared to FY23 as a result of improved head grades from moving into the Kapit zone; and
- the recent operating challenges with the processing plant producing well below its nameplate capacity. Earnings in FY23 are unlikely to reflect Lihir’s full potential.

The implied EBITDA multiples for Lihir would be expected to decline and naturally gravitate more in line with its peers as it delivers on its production ramp-up and approaches its earnings capacity.

On the other hand, the implied resource and reserve multiples are at the bottom end of the range of the market evidence and at a discount even to the listed gold producers exposed to “risky” jurisdictions. This discount is attributable to its arguably unique set of geotechnical and operating challenges as well as the uncertainty attached to production beyond the end of its mining lease (with more than 70% of Lihir’s mineral resource expected to be remaining to be mined after FY35) and the inherent sovereign risks (e.g. post-2035).

4.3.4 Telfer and Havieron

Summary

Grant Samuel has valued Telfer in the range \$500-600 million. The valuation incorporates the value of the existing operating mine at Telfer and the value of the Havieron Project (at Newcrest’s 70% interest).

Scenarios and Assumptions

The valuation of Telfer’s core operations (inclusive of Havieron) is based on production scenarios developed by AMC. The valuation assumptions are summarised below (all costs are presented on a real FY23 basis and on a 100% basis).

SCENARIO 1

Scenario 1 assumes that Newcrest successfully develops the Havieron project and identifies new mining fronts to extend the operating life of Telfer. The production case includes the following assumptions:

- total ore production of 59Mt over the project life, including:
 - 37Mt from Telfer’s existing open pit and mining fronts through to FY26. Head grades decline to less than 0.5 g/t gold and 0.1% copper as the ore reserves in these areas are depleted;
 - 8Mt from new higher grade underground mining fronts in Telfer at slightly lower production rates than the historical underground operations (at around 0.9Mtpa). Production from these areas are assumed to commence in FY28 and run through FY35; and
 - 14Mt from Havieron from FY27 to FY35, which ramps up to 2Mtpa in the second year of operations. Head grades are substantially higher than at the legacy mining operations at Telfer (averaging around 3.7 g/t gold and 0.5% copper);
- total ore milled broadly equals ore production in each year (with the exception of the wind-down of ore stockpiles in the first years of operations). Following the conclusion of open pit mining operations, recovery rates are expected to jump from around 75% to 87-91%.



GRANT SAMUEL



As a result, gold production over the project life is approximately 2.4Moz and can be broadly categorised into two distinct phases:

- between FY24 and FY26, a sharp decline from around 400koz of gold in FY24 (consistent with historical periods) to just 120koz in FY25 and 90koz in FY26 (and zero in FY27); and
- between FY28 and FY32, approximately 250-290koz gold per annum as higher grade ore from the new mining areas is processed before ramping down in the final three years of operations. Havieron accounts for around 75-80% of gold production in each year.

Approximately 490koz of gold sales are assumed to be hedged at fixed Australian dollar contracts through FY26 (representing approximately 77% of total sales over that period). The balance is sold at spot prices.

Total copper production over the project life is approximately 100kt and produced at 9kt per annum over the project life (higher production rate in the second phase due to improved copper head grades and recovery rates);

- cash operating costs of approximately \$53/t of milled ore over the project life, reflecting the step-change in cost profile
 - from FY24 to FY26, as the lower cost open-pit mining operation winds down; and
 - from FY27 onwards, as operating costs step up due to the transition to underground-only operations at both Telfer and Havieron;
- other costs including state royalties (approximately 2.5% of gold revenue and 5.0% of copper revenue), treatment and refinery charges, tolling recoveries (for Havieron), penalties and cash rehabilitation costs (assumed to be approximately \$160 million for Telfer and \$105 million for Havieron);
- total capital expenditure comprises:
 - upfront development costs in relation to Havieron (primarily incurred between FY24 and FY27). The capital expenditure is based on the initial estimates contemplated in the 2021 pre-feasibility study and escalated for cost inflation, scope changes and new geotechnical information;
 - other growth capital expenditure of approximately \$35 million (most of which is incurred between FY28 and FY32) to develop new Telfer underground mining extensions; and
 - sustaining capital expenditure of approximately \$30 million per annum (total at both Telfer and Havieron); and
- income tax rate of 30% (the Australian corporate tax rate).

SCENARIO 2

Scenario 2 incorporates the development of:

- 19Mt in incremental ore inventory from Havieron (33Mt total) as a result of successful resource-to-reserve conversion, including the inferred resource zone at the high grade Southeast Crescent Zone and Breccia Zone. Mining rates improve to 3Mtpa and extend the mine life to FY39; and
- 14Mt in incremental ore inventory at Telfer underground (22Mt total). Mining rates ramp up to as high as 3.5Mtpa and extend the mine life to by an additional year to FY36.

Total ore milled increases to nearly 100Mt over the project life (representing over 55% of total mineral resource at Telfer's operating deposits and Havieron). As higher grade areas are included in Scenario 2, total gold and copper production over the mine life increase by a greater proportion to 4.3Moz gold and 184kt copper over the life of mine.

Annexure 1. Independent Expert's Report

GRANT SAMUEL



Cash operating costs are slightly higher (approximately \$55/t of milled ore over the project life) as more production is weighted towards the higher cost underground operations than in Scenario 1. Capital expenditure is expected to be approximately \$320 million higher than in Scenario 1 due to the investments associated with developing new underground mining fronts (of which approximately 85% of the incremental spend is incurred in Havieron). Rehabilitation costs are expected to be unchanged.

The following chart shows the ore volumes assumed to be produced from Telfer (inclusive of Havieron) (on a 100% basis) as well as the expected gold and copper in each year (incremental volumes from Scenario 2 are represented by dotted lines):

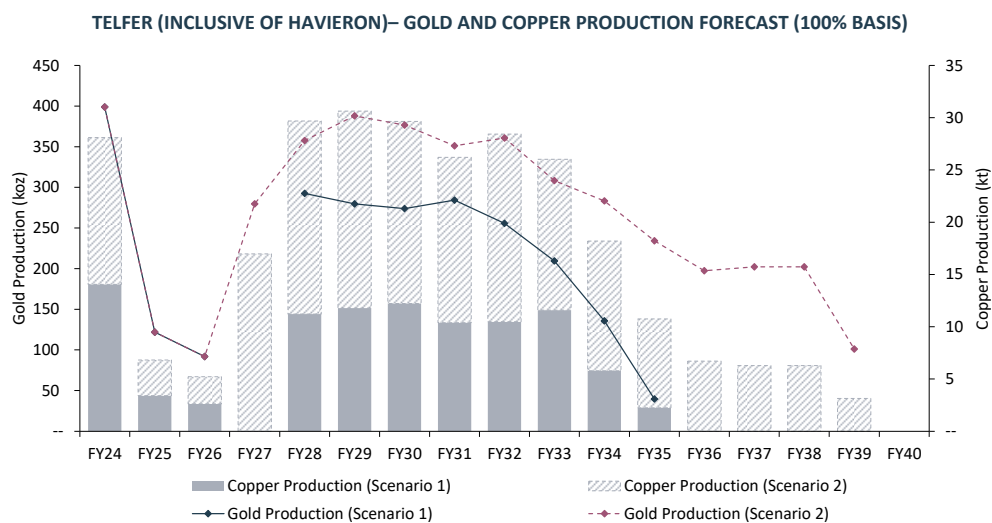

Source: AMC analysis

DCF Outputs and Valuation

The following table summarises the projected production and costs:

TELFER CORE OPERATIONS (INCLUSIVE OF HAVIERON) – MODEL PARAMETERS (100% BASIS)

	UNIT	FY24	FY25	FY26	FY27	FY28	LIFE OF MINE
Scenario 1							
Ore mined	Mt	25	7	7	1	3	59
Ore milled	Mt	21	10	8	--	3	61
Gold grade	g/t	0.73	0.49	0.49	--	3.39	1.44
Copper grade	%	0.09	0.05	0.05	--	0.41	0.19
Production							
Gold	koz	399	122	92	--	293	2,384
Copper	kt	14	3	3	--	11	96
Cash costs (real FY23 basis)	\$/t milled ore	23.1	22.4	27.2	--	87.5	52.6
Capital expenditure (real FY23 basis)	\$ millions	107	37	177	335	127	993



GRANT SAMUEL



TELFER CORE OPERATIONS (INCLUSIVE OF HAVIERON) – MODEL PARAMETERS (100% BASIS) (CONT)

	UNIT	FY24	FY25	FY26	FY27	FY28	LIFE OF MINE
Scenario 2							
Ore mined	Mt	25	7	7	4	6	92
Ore milled	Mt	21	10	8	4	6	96
Gold grade	g/t	0.73	0.49	0.49	2.39	2.08	1.64
Copper grade	%	0.09	0.05	0.05	0.46	0.34	0.23
Production							
Gold	koz	399	122	92	280	358	4,256
Copper	kt	14	3	3	17	18	184
Cash costs (real FY23 basis)	\$/t milled ore	23.1	22.4	35.6	79.8	68.1	54.7
Capital expenditure (real FY23 basis)	\$ millions	142	235	421	139	70	1,314

The following chart aggregates the NPV outcomes for Telfer (inclusive of Newcrest’s 70% interest in Havieron) together with the value attributed by AMC to any remnant resource and exploration targets (a total of \$133 million in Scenario 1 and \$86 million in Scenario 2):

**TELFER (INCLUSIVE OF HAVIERON) – VALUE OUTCOMES (\$ MILLIONS) (ATTRIBUTABLE BASIS)
(6.5-7.5% NOMINAL DISCOUNT RATE)**

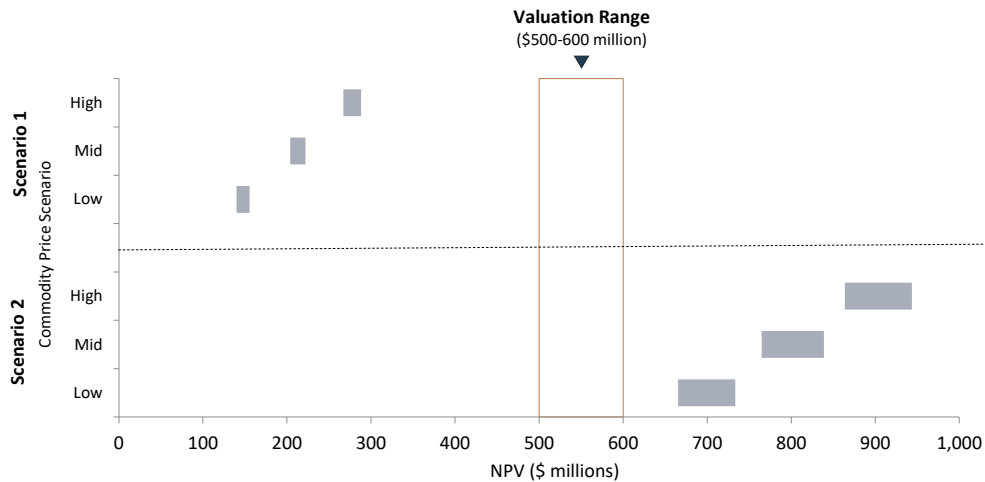

Grant Samuel’s valuation range of \$500-600 million takes into account a number of subjective judgements, particularly the:

- future resource-to-reserve conversion from Telfer underground; and
- valuation upside from the development of Havieron.

The value of existing mining operations at Telfer is constrained by its remaining reserve life and is further capped by its declining free cash flow profile over that period as a result of naturally declining grades and cutback investments. While Telfer has consistently generated EBITDA in excess of \$100 million per annum in recent years, free cash flows have been substantially lower.

Extensions will be required to sustain ongoing operations at Telfer beyond FY26 and defer its rehabilitation obligations. Studies to extend the open pit mining operations remain at very early stages and have not been included in the valuation. On the other hand, studies for additional underground mining fronts are more advanced but collectively would still mean a substantial reduction in scale at Telfer (as the open pit

Annexure 1. Independent Expert's Report

GRANT SAMUEL



mine historically comprised over 75% of ore production at Telfer). The DCF analysis indicates that the Telfer mine extensions contemplated in either Scenario 1 and Scenario 2 are expected to be subscale and marginal contributors to value.

Accordingly, the positive value hinges on the value of Newcrest's interest in the Havieron project. The discount to the Scenario 2 NPV reflects Havieron's status as a development project that is still subject to a feasibility study (and subsequent FID).

The recent negotiations between Newcrest and Greatland Gold plc ("Greatland"), which owns 30% of Havieron, can also provide some (albeit limited) evidence to value. These include announcements in:

- March 2022, that Greatland made a non-binding offer to acquire a 5% interest for \$85 million (implied value of \$1.7 billion for 100% of Havieron) which was not progressed; and
- August 2022, that an independent valuer determined that the option exercise price for a 5% interest to be \$60 million (implied value of \$1.2 billion for 100% of Havieron). The valuation was based on information (including geological data) available at 15 December 2021. Newcrest declined to exercise the option, stating that the price "did not meet Newcrest's investment hurdles".

The implied values resulting from these discussions are contradictory (the value of Havieron cannot be both less than \$1.2 billion and greater than \$1.7 billion). On the other end, the value ascribed by the independent valuer reflects the prescriptive process and principles outlined for the in the joint venture agreement. In most instances, Newcrest's decision not to exercise the option (particularly given its knowledge of the asset) would suggest that \$1.2 billion is a notional "ceiling" to the value of Havieron. However, there are several factors to suggest that the project value may have changed since then:

- over 1.9Moz of gold and 0.05Mt of copper have been added to mineral resource (approximately a 50% increase over previous estimates); and
- exploration studies and drilling continue to progress and the feasibility study is currently being undertaken.

On the other hand, upfront capital expenditure estimates are expected to increase materially due to the expanded scope and increased geotechnical and hydrogeological understanding of the deposit.

While it is difficult to make any definitive conclusions from these two datapoints, it is clear that the implied values resulting from these discussions are materially higher than the NPV outcome in the pre-feasibility study that was completed in October 2021 (\$228 million). The significant uplift is due to the nature of the study, which calculated NPVs based on long term gold and copper prices of \$1,500/oz and around \$7,250/t, respectively. Valuation parameters in the current market environment would involve assumptions that would result in materially higher NPVs.

Another valuation benchmark is the recent share price performance and capital raisings undertaken by Greatland. Havieron is Greatland's flagship asset and comprises most, if not all, of the company's value (as its other exploration projects and joint ventures are less advanced and do not have any mineral resource). The analysis is set out below:



GRANT SAMUEL



IMPLIED VALUE OF HAVIERON BASED ON MARKET EVIDENCE FROM GREATLAND

	SHARE PRICE 30 JUNE 2023	WYLOO CAPITAL RAISING 12 SEPTEMBER 2022 ³³
Share price (pence per share)	7.2	7.8
Total outstanding shares	5,069	5,002
Implied market capitalisation (100%)	365	390
Net debt/(cash)	(16) ³⁴	(28)
Implied enterprise value (£ millions)	349	362
Implied enterprise value (\$ millions)	443	424
<i>IMPLIED VALUE OF HAVIERON</i>		
<i>Implied value of a 70% interest in Havieron (\$ millions)</i>	<i>1,034</i>	<i>989</i>
<i>Implied value of a 100% interest in Havieron (\$ millions)</i>	<i>1,477</i>	<i>1,412</i>

The analysis broadly points to a value for 100% of Havieron of around \$1.4 billion. However, the valuation evidence from Greatland's share price must be considered in light of its share price and its volatility. It has very limited broker coverage (only three analysts).

Wyloo Metals is a sophisticated investor that is familiar with the mining industry (albeit with no other investments in the gold sector). However, while its investment in Greatland represents a useful third party, arms' length value for the project, it is necessary to recognise the emerging picture of materially higher development costs subsequent to the investment.

Taking these factors into consideration, Grant Samuel considers the valuation range for Telfer (including 70% of Havieron) of \$500-600 million (inclusive of the value of remnant mineral resources) to be a reasonable balancing of these issues.

Valuation Cross Checks

The valuation range for Telfer (inclusive of Havieron) implies the following valuation parameters:

TELFER (INCLUSIVE OF HAVIERON) – IMPLIED VALUATION PARAMETERS

	VARIABLE	IMPLIED MULTIPLE	
		LOW	HIGH
Valuation range (Newcrest share) (\$ millions)		500	600
Operating metrics			
FY23 EBITDA (actual) (times)	\$124 million	4.0	4.8
FY23 gold production (actual) (\$/oz)	349koz	1,433	1,719
Attributable resources and reserves			
Gold resources (\$/oz)	9.3Moz	54	65
Gold reserves (\$/oz)	2.4Moz	208	250

The implied EBITDA multiples for Telfer (inclusive of Havieron) are very low relative to the rest of Newcrest's mineral assets (as well as the rest of the market evidence) due to the limited life of its open pit operations (closing in FY26).

The resource multiples for Telfer (inclusive of Havieron) are below the market evidence due to the:

³³ On 12 September 2022, Greatland announced that Wyloo Metals would subscribe for 430,024,390 ordinary shares, priced at 8.2 pence per share (based on the Greatland share price at the date of the agreement), totalling £35 million (approximately 8.6% of Greatland's shares on issue). Wyloo will also receive warrants to subscribe for an additional 352,620,000 ordinary shares at an exercise price of 10.0 pence per share which, if exercised in full, will realise gross proceeds of another £35m. Settlement occurred on 14 October 2022 at a converted share price of £0.078 per share.

³⁴ Based on Greatland Gold net cash at 31 December 2022.

Annexure 1. Independent Expert's Report

GRANT SAMUEL



- significant upfront capital to develop Havieron (relative to the project's value at this point in time);
- lack of clarity for future growth plans, as the feasibility study for Havieron is still underway and more work is required to better define the extent of the underground mine extensions at Telfer; and
- challenging economics at Telfer's existing operations, which are further impacted by the rehabilitation obligations at the end of its life.

The reserve multiples are more towards the middle of the range of the market evidence due to the very high resource-to-reserve ratio (over 4 times) and expectation that extending the operating life of Telfer beyond FY26 will lead to additional conversions of mineral resource to reserves. The production cases incorporate some of this upside, particularly at Havieron, which has only recognised 14Mt in ore reserves (but has 32Mt of ore included in Scenario 2 of the DCF analysis).

In Grant Samuel's view, the multiples are a reasonable balancing of the opportunities and risks at Telfer.

4.3.5 Red Chris

Summary

Grant Samuel has valued Newcrest's interests in the Red Chris joint venture in the range \$2,100-2,450 million (or \$3,000-3,500 million on a 100% basis). The valuation incorporates the value of the existing operating mine at Red Chris and the value of the block cave mine expansion as well as any remnant resource.

Scenarios and Assumptions

The valuation of Red Chris's core operations is based on production scenarios developed by AMC. The valuation assumptions are summarised below (all costs are presented on a real FY23 basis).

SCENARIO 1

Scenario 1 is based on the 2021 pre-feasibility study, with more recent studies completed on the open mining operation. This scenario assumes that Red Chris fully transitions from an open mining operation to an underground block cave mining operation by FY27 and includes the following assumptions:

- total ore production of 449Mt over the project life. Existing open pit mining operations will continue for three years before concluding in FY26 (producing a total of 44Mt until ore reserves are depleted). First ore from the block cave expansion is expected in FY25 and production gradually ramps up to 13.6Mtpa by FY30.

The block cave will have a 33-year mine life and source production from:

- MB1, which will produce over 156Mt of ore between FY27 and FY41 at the highest head grades (average gold grade of approximately 0.77g/t and copper grades of approximately 0.59%, excluding development ore);
 - MB2, which will produce over 76Mt of ore between FY36 and FY48 at lower head grades of gold and copper than MB1, and must be first mined in order to access MB3; and
 - MB3, which will produce over 173Mt of ore between FY41 and FY57 (at similar grades to MB2).
- total ore milled equals ore production in each year (with the exception of the wind-down of ore stockpiles). The process plant upgrade is completed in FY27 and allows Red Chris to accommodate up to 13.6Mtpa in treatment capacity by the following year.



GRANT SAMUEL



Recovery rates step up as the mill feed transitions from the open pit ROM ore and ore stockpiles (around 81-82% for copper and 50% for gold) to the initial ROM ore from the block cave (around 83-85% for copper and around 75% for gold) before reverting to earlier levels.

Due to the combined impact of these factors, copper and gold production ramp up sharply in the initial years of the block cave mining operations (to more than 85ktpa copper and more than 365koz per annum gold by FY31) before declining as higher grade areas are exhausted and recovery rates decline. Total copper production of 1.7Mt and gold production of 5.1Moz is expected over its mine life (or approximately 1.6Mt copper and 4.9Moz gold for the block cave);

- cash operating costs (i.e. mining and milling costs) of approximately \$18/t of milled ore over the project life, reflecting the improved operating cost profile as mining transitions from the open pit mine to the underground block cave;
- other costs including royalties (i.e. revenue sharing agreements with the Tahltan Nation and separate private royalties International Royalty Corporation) as well as treatment and refinery charges, penalties and cash rehabilitation costs;
- total capital expenditure of \$2.7 billion over the project life. Non-sustaining capital comprises the majority of the investments and include:
 - \$1 billion to complete the development of the Red Chris block cave and supporting infrastructure (e.g. processing plant upgrade);
 - \$200 million to develop MB2 (between FY35 and FY38); and
 - \$360 million to develop MB3 (between FY39 and FY44).

Approximately \$30 million in sustaining capital is incurred each year for plant and equipment maintenance and other non-growth spend; and

- income tax rate of 27% (the Canadian corporate tax rate), including any relevant mineral taxes³⁵.

SCENARIO 2

Scenario 2 represents an upside scenario wherein Red Chris successfully converts approximately 220Mt of underground inferred resource into ore reserve. East Ridge remains unmined. Mining life is extended by 12 years to FY70. The processing plant is upgraded as per the current Feasibility Study scope to incorporate coarse ore flotation technologies that can accommodate a wider variation in grind sizes and support a higher throughput capacity of 15Mtpa by FY30. Incremental capital spend for the plant upgrade is approximately \$100 million.

The following chart shows the ore volumes assumed to be produced from Red Chris (on a 100% basis) as well as the expected gold and copper in each year (incremental volumes from Scenario 2 are represented by dotted lines):

³⁵ British Columbia Mineral Tax applies, either at a minimum rate of 2% of net operating profits, or, at a rate of 13% of net revenue, once accumulated life to date revenue from the project has exceeded the accumulated life to date capital and operating costs of the project, adjusted for annual investment allowance.

Annexure 1. Independent Expert's Report

GRANT SAMUEL



RED CHRIS – FORECAST PRODUCTION (100% BASIS)

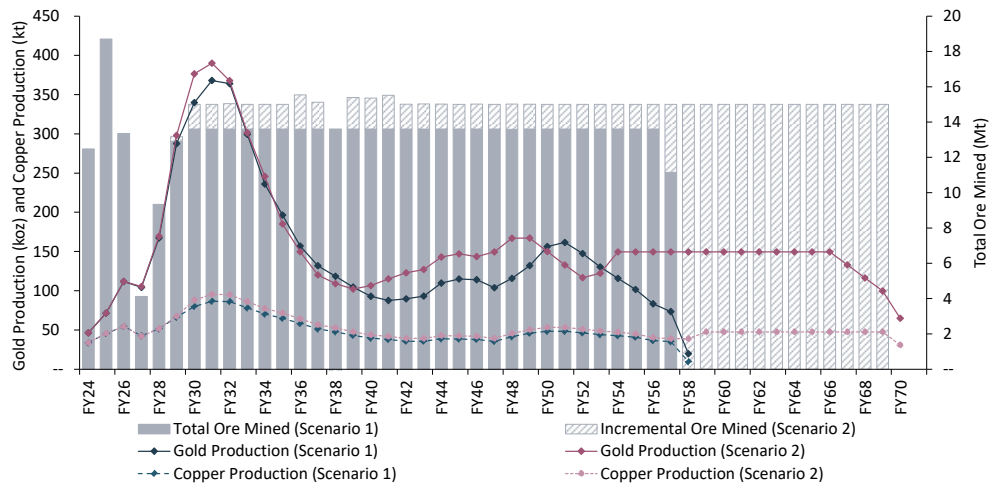

Source: AMC analysis

DCF Outputs and Valuation

The following table summarises the projected production and costs:

RED CHRIS CORE OPERATIONS – MODEL PARAMETERS (100% BASIS)

	UNIT	FY24	FY25	FY26	FY27	FY28	LIFE OF MINE
Scenario 1							
Ore mined	Mt	12	19	13	4	9	449
Ore milled	Mt	11	11	11	11	14	455
Gold grade	g/t	0.27	0.42	0.60	0.51	0.63	0.54
Copper grade	%	0.39	0.50	0.59	0.47	0.46	0.45
Production							
Gold	Koz	46	72	112	104	167	5,148
Copper	Kt	34	46	55	43	51	1,700
Cash costs (real FY23 basis)	\$/t ore milled	22.7	20.7	17.4	15.6	16.5	18.4
Capital expenditure (real FY23 basis)	\$ millions	414	406	269	137	77	2,672
Scenario 2							
Ore mined	Mt	12	19	13	4	9	672
Ore milled	Mt	11	11	11	14	14	684
Gold grade	g/t	0.27	0.42	0.60	0.42	0.64	0.51
Copper grade	%	0.39	0.50	0.59	0.38	0.46	0.43
Production							
Gold	Koz	46	72	112	105	169	7,419
Copper	Kt	34	46	55	42	52	2,427
Cash costs (real FY23 basis)	\$/t ore milled	22.7	20.7	17.4	15.2	16.8	18.5
Capital expenditure (real FY23 basis)	\$ millions	414	444	299	152	92	3,104

The following chart aggregates the NPV outcomes for Red Chris (based on a 100% basis) together with the value attributed by AMC to any remnant resource and exploration targets (\$159 million in Scenario 1 and \$65 million in Scenario 2):

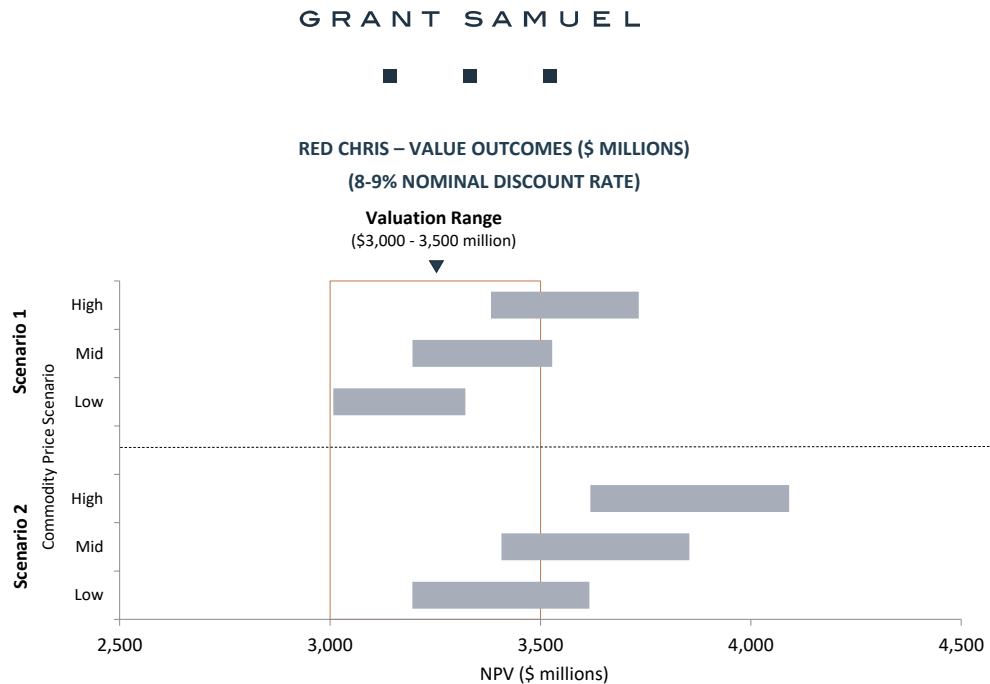

The valuation range of \$3,000-3,500 million (on a 100% basis) sits at the bottom end the range of value outcomes for both Scenario 1 and Scenario 2. In Grant Samuel's view, this is reasonable as the current gold price is closer to the low and mid scenarios and there are other factors that may not be fully captured in the cash flows or discount rate including:

- project development risks. Undertaking the Red Chris block cave expansion is a significant task. Approximately \$1.0 billion of upfront capital remains to be incurred and production has not yet begun from the block cave. A series of milestones need to be reached to progressively de-risk its development. Since completing the pre-feasibility study in October 2021, Newcrest has continued to:
 - progress further studies and testing;
 - advance the exploration decline (currently at nearly 3km) including the first ventilation raise; and
 - undertake the feasibility study (with the aim of finalising it in the latter half of 2023).
 While capital and operating cost estimates should be largely up-to-date and reflective of the recent inflationary pressures on costs, any cost overruns beyond the contingency allowances or construction delays (while unknown at this stage) will have a direct impact on the value outcomes; and
- production and cost risks. While Newcrest has undertaken extensive studies (e.g. geological drilling, mine planning, process flowsheet design, metallurgy testing, etc.), Red Chris remains in the feasibility study stage and, at this stage, has no track record of underground operating history nor has it reached FID for development. There are a number of key assumptions (e.g. production levels, operating costs) that remain to be tested under actual working conditions and some others (e.g. geological characteristics) that will only be ascertained with greater certainty once production commences.

At the same time, development risks are arguably at the lower end of the spectrum (at least relative to Newcrest's peers) in light of:

- Newcrest's deep expertise and technical capabilities in block caving;
- general progress in applying block caving methods over the past few decades (thereby improving the safety and operational robustness of the technique); and
- similarities between the Red Chris and Cadia orebodies, where Newcrest has a track record of over 25 years of operations.

Annexure 1. Independent Expert's Report

GRANT SAMUEL



Nevertheless, the valuation range for Red Chris (based on the currently recognised mineral resource and ore reserves) should sit below the bottom end of the value outcomes to account for this risk. However, this would understate the material value upside from the East Ridge development. The NPV outcomes reflect no value upside from developing the East Ridge deposit as two standalone block caves because it remains an exploration target and has not been declared a production target. However, there is evidence that the potential value of the deposit is substantial including its:

- scale, which could support a ~20 year extension to the mine life at Red Chris;
- high grades (particularly copper), which provides mining optionality that could change the whole sequence of the block cave with East Ridge potentially mined ahead of MB2 (bringing forward additional cash flows); and
- location, which allows it to leverage the existing infrastructure at Red Chris and reduce upfront capital investments to develop the mine.

While mine planning studies remain at very early stages and no resource has been declared by Newcrest at this stage, substantial works and drill testing have been completed and continue to support the potential value upside from East Ridge. A DCF analysis based on the draft studies would yield incremental NPVs in the range of \$800 million to \$1 billion to develop and advance the East Ridge deposit (albeit these NPV outcomes are un-risked).

Grant Samuel's selected valuation range therefore reflects some of this upside from East Ridge (as an offset to the development risk).

Grant Samuel also took into account other valuation benchmarks including:

- Newcrest's acquisition of Red Chris in 2019. The selected valuation range reflects an uplift in value of approximately 2.5 to 3 times the implied enterprise value of Red Chris when Newcrest acquired a 70% interest in the mine in 2019 (approximately \$800 million for the 70% interest). The uplift in value reflects:
 - improved mineral resource and ore reserve definition. Since the transaction, Newcrest has undertaken a comprehensive program to update the mineral resource and ore reserve statement;
 - material progress on the block cave development, including the completion of a pre-feasibility study for the block cave development in 2021 and the continued progress in relation to the feasibility study.
 - new exploration success, in particular the discovery of the East Ridge deposit; and
 - stronger copper and gold prices, which were at around \$6,000-6,500/t and \$1,300-1,500/oz at the time of the transaction (compared to around \$8,250-8,750/t and \$1,900-2,000/oz today).
- the pre-feasibility study in 2021. The valuation range is also at a premium to the net present values set out in the pre-feasibility study. While some of this difference can be attributed to the copper price and gold price assumptions used at the time, the difference can also be explained by the substantial work more recently undertaken for the feasibility study and the testing and drilling results from the East Ridge exploration target.

Grant Samuel has also considered the market value of the shares in Imperial Metals Corporation ("Imperial"), which holds the remaining 30% interest in Red Chris as well as interests in two substantially smaller assets (Mount Polley mine and Huckleberry mine). The implied value of Red Chris (based on Imperial share prices and assuming negligible value to Imperial's other mineral assets) is substantially lower than the selected valuation range. In Grant Samuel's view, Imperial's share price may not be a reliable benchmark for value as it is likely impacted by its low free float (65% of its share register is controlled by just three parties) and very low liquidity. Imperial also faces substantially higher financial risk than most other gold producing peers (approximately 40% gearing). In any event, it appears that its share price may

GRANT SAMUEL



be influenced by other factors besides Red Chris (or the recent appreciation in gold and copper prices) as it has declined by approximately 50% since the announcement of the pre-feasibility study in October 2021 and is trading below the levels when the sale of its 70% interest in Red Chris was completed.

Taking all of these factors into account, Grant Samuel considers the valuation range of \$3,000-3,500 million (on a 100% basis) reflects a reasonable balancing of the upside potential from East Ridge and the development risks from the block cave expansion.

Valuation Cross Checks

The valuation range for Red Chris implies the following valuation parameters:

RED CHRIS – IMPLIED VALUATION PARAMETERS

	VARIABLE	IMPLIED MULTIPLE	
		LOW	HIGH
Valuation range (100% basis) (\$ millions)		3,000	3,500
Operating metrics			
FY23 EBITDA (actual) (times)	\$(7) million ³⁶	nmc	nmc
FY23 gold production (actual) (\$/oz)	56koz ³⁶	53,846	62,821
Resources and reserves			
Gold resources (\$/oz)	14.1Moz	213	248
Gold reserves (\$/oz)	7.8Moz	385	449
Resources (including East Ridge)			
Gold resources (\$/oz)	20Moz ³⁷	151	176

It is difficult to evaluate the implied multiples of the valuation of Red Chris.

While it may be argued that the most relevant market benchmark is Newcrest's acquisition of a 70% interest in Red Chris in 2019. That transaction occurred in a very different price environment and included some "noise" in the EBITDA multiples (particularly due to the low profitability of the mine under previous ownership).

The EBITDA multiples are substantially higher than any of its peers but they are not relevant as EBITDA only represents earnings from the current open pit mining operation that will cease operations in FY26). The block cave expansion will have a transformational impact on Red Chris' earnings profile (which is quite challenged as an open pit mining only). Gold production multiples are even less meaningful given its substantial copper exposure and growth outlook.

The substantial progress that has been made in the development of the block cave is reflected in gold resource multiples that are significantly higher than at the time of acquisition (an increase from just \$63/oz to \$220-250/oz excluding East Ridge or \$155-175/oz including the East Ridge exploration target).

The resource and reserve multiples are also at the top end of the market evidence which is appropriate given its large exposure to copper³⁸ (which is at the top end of the listed peers and transaction evidence). However, they are at a slight discount to Cadia due to the significant near-term capital requirements and development risks in relation to its block cave (in contrast to Cadia, which is a mature asset) and will come down further if East Ridge resources are declared.

In Grant Samuel's view, the multiples for Red Chris represent a reasonable balancing of its growth potential and risks.

³⁶ Adjusted to be shown on a 100% basis.

³⁷ Based on the midpoint estimate for the gold in resource at the East Ridge exploration target.

³⁸ The multiples are based on gold reserves only. The large copper content serves to substantially reduce the cost of gold production when treated as a negative cost. Accordingly, profit per oz of gold is much higher.

Annexure 1. Independent Expert's Report

GRANT SAMUEL



4.3.6 Brucejack

Summary

Grant Samuel has attributed a value in the range \$3,000-3,300 million to Brucejack.

Scenarios and Assumptions

The valuation of Brucejack's core operations is based on production scenarios developed by AMC. The valuation assumptions are summarised below (all costs are presented on a real FY23 basis).

SCENARIO 1

Scenario 1 is based solely on the existing ore reserves at Brucejack and assumes no upsides for resource-to-reserve conversion success or debottlenecking. It includes the following assumptions:

- total ore mined of 14Mt over the 10-year mine life. Annual ore mining rates remain consistently at 1.4Mtpa until it winds down and ultimately ceases in FY33;
- total ore milled equals total ore mined in each year as no major upgrades or debottlenecking initiatives are implemented. Recovery rates remain at 97% over the project life to produce 3.6Moz of gold in the form of either:
 - gold doré, which represents approximately 65% of total output (or 230koz per annum); and
 - gold concentrate, which represents the remaining 35% of total output (or 125koz per annum).

Brucejack also produces 13Moz of silver by-products over its mine life, albeit at variable rates each year given fluctuating head grades (but in any event, represents only 4% of total revenue);

- cash operating costs of approximately \$174/t of milled ore over the project life, reflecting the very high mining costs at Brucejack (albeit offset by the very high grades when measured on a per oz of gold sold basis);
- other costs including royalties (i.e. First Nations royalty and a separate private royalty with Franco-Nevada Corporation) as well as treatment and refinery charges, penalties and cash rehabilitation costs (approximately \$80 million at the end of the mine life);
- total capital expenditure of \$196 million over the project life which is in relation to recurring sustaining capital expenditure requirements; and
- income tax rate of 27% (the Canadian corporate tax rate), including any relevant mineral taxes³⁵.

SCENARIO 2

Scenario 2 represents an upside scenario that includes:

- successful resource-to-reserve conversion as approximately 3Moz of additional gold is produced to extend the mine life by six years; and
- increased production capacity as a result of de-bottlenecking initiatives across the:
 - mining operations, including increased mining fronts, different mining methods and upgraded electrical and ventilation systems; and
 - processing operations, including additional coarse ore processing capacity, water management systems and other investments.

The debottlenecking initiatives require \$150 million in upfront non-sustaining capital to be incurred between FY24 and FY26. As a result of these initiatives, mining and milling throughput increases to 1.8Mtpa by FY26 and cash operating costs are reduced to \$157/t milled ore.





GRANT SAMUEL



The following chart shows the ore volumes assumed to be produced from Brucejack as well as the expected gold and copper in each year (incremental volumes from Scenario 2 are represented by dotted lines):

BRUCEJACK – PRODUCTION FORECAST

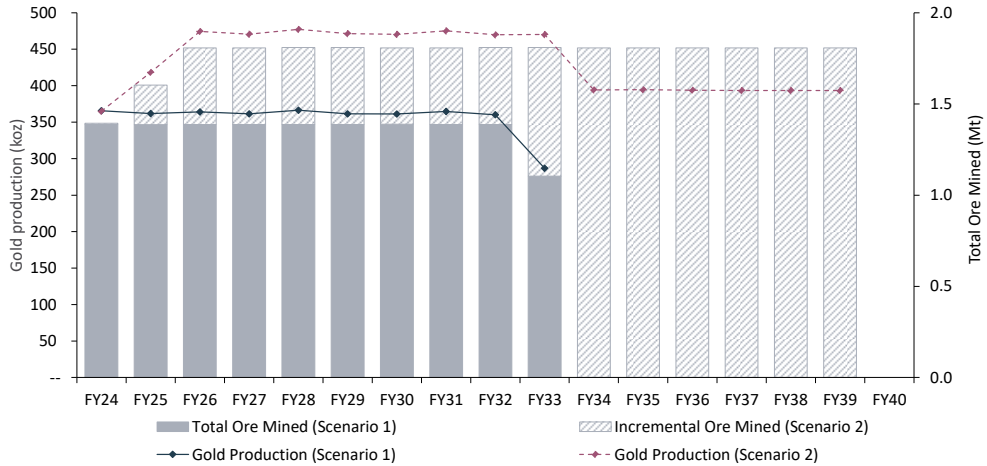

Source: AMC analysis

DCF Outputs and Valuation

The following table summarises the projected production and costs for the two scenarios:

BRUCEJACK CORE OPERATIONS – MODEL PARAMETERS

	UNIT	FY24	FY25	FY26	FY27	FY28	LIFE OF MINE
Scenario 1							
Ore mined	Mt	1.4	1.4	1.4	1.4	1.4	13.6
Ore milled	Mt	1.4	1.4	1.4	1.4	1.4	13.6
Gold grade	g/t	8.41	8.37	8.42	8.35	8.45	8.39
Silver grade	g/t	19.70	39.12	33.80	22.50	22.50	34.82
Production							
Gold	koz	366	362	364	361	366	3,553
Silver	kt	748	1,533	1,324	882	875	13,359
Cash costs (real FY23 basis)	\$/t ore milled	172.2	172.1	172.2	172.2	172.0	173.6
Capital expenditure (real FY23 basis)	\$ millions	43	28	28	24	23	196
Scenario 2							
Ore mined	Mt	1.4	1.6	1.8	1.8	1.8	28.3
Ore milled	Mt	1.4	1.6	1.8	1.8	1.8	28.3
Gold grade	g/t	8.41	8.37	8.42	8.35	8.45	7.85
Silver grade	g/t	19.70	39.12	33.80	22.50	22.50	35.33
Production							
Gold	koz	365	418	474	471	477	6,925
Silver	kt	752	1,772	1,725	1,149	1,140	28,393
Cash costs (real FY23 basis)	\$/t ore milled	171.9	162.9	156.2	156.2	156.1	157.3
Capital expenditure (real FY23 basis)	\$ millions	113	86	47	24	23	513

Annexure 1. Independent Expert's Report

GRANT SAMUEL



The following chart aggregates the NPV outcomes for Brucejack together with the value attributed by AMC to remnant resource and exploration targets (\$129 million in Scenario 1 and \$58 million in Scenario 2):

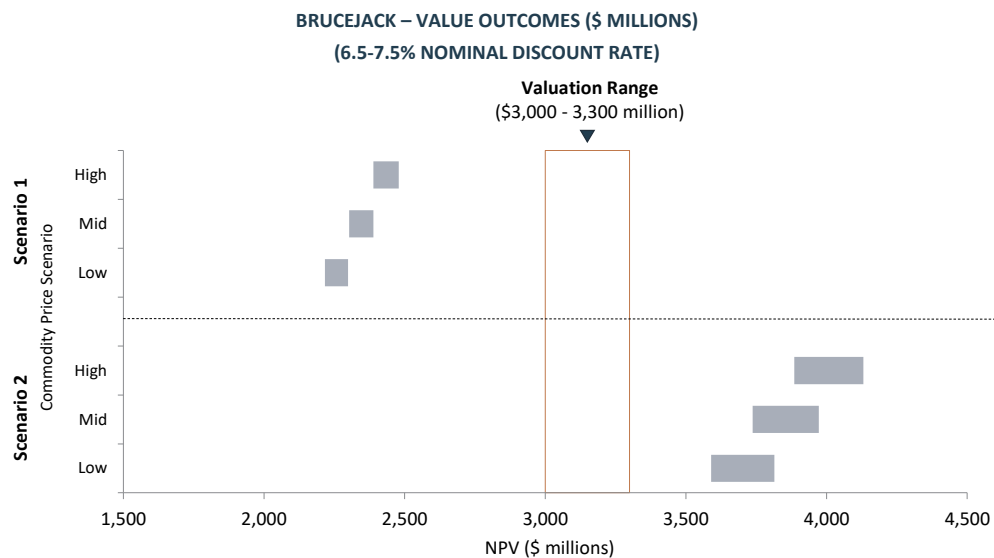

Grant Samuel's valuation range of \$3,000-3,300 million takes into account the value outcomes set out above and reflects the different risks between the two production scenarios:

- Scenario 1 reflects a conservative scenario that assumes only the existing ore reserves are mined over a 10-year mine life through FY34. Despite the comprehensive exploration works undertaken at Brucejack over the last two years, the production case does not assume any material upside since Pretivm last prepared the technical report for the mine in 2020. Moreover, it assumes milling rates remain at around 3,800tpd although Brucejack has already successfully debottlenecked some of its operations to achieve closer to 4,200tpd run rates. Accordingly, the valuation range sits well above the top end of the value outcomes for Scenario 1; and
- Scenario 2 reflects an upside scenario that assumes that a substantial proportion of the mineral resource is mined. However, there is a considerably higher level of risk in Scenario 2. The majority of the incremental resource is classified as inferred resource, reflecting a higher level of estimation uncertainty ascribed to the mineralisation in these resources. While the production case accounts for some dilution factors (thereby reducing the total ore inventory to around 7Moz from the estimated 12Moz in mineral resource), there is some risk to assuming the entire mineral resource base is extracted (let alone maintaining the same mining and milling cost profile over the extended project life). Accordingly, the valuation range sits below the bottom end of the value outcomes for Scenario 2.

The valuation range is at a slight premium to Newcrest's \$2.8 billion acquisition of Pretivm in 2022. Since the acquisition, there is some evidence that the value of Brucejack has increased:

- early successes from the debottlenecking initiatives, as milling throughput has improved from 3,800tpd to 4,200tpd (and continues to be progressed towards an improvement to at least 4,500tpd);
- improved certainty of resource-to-reserve conversion profile, following the completion of the comprehensive works program to update the ore reserve and mineral resource estimates; and
- exploration success, as the aggressive exploration program has targeted deeper areas of the deposit and expanded the footprint of mineralisation (including at the primary Valley of the Kings deposit).

GRANT SAMUEL



On the other hand, the current gold price environment is at broadly similar levels to the time of acquisition and Brucejack continues to produce at a rate of approximately 300koz of gold per annum (with the updated ore reserves estimate remaining broadly in line with Pretivm's prior estimates).

The acquisition was the culmination of a competitive sale process conducted by Pretivm which attracted another competing non-binding proposal. The other proposal was structured as a nil-premium "merger of equals" that attributed a value of approximately \$2.2 billion for the company (approximately 20% less than Newcrest's offer). While some analysts suggested that Newcrest's offer price represented "full value" for the mine (i.e. incorporates value for improvements and exploration success to be achieved in the future), the value implied by the other proposal suggests that Newcrest's offer was broadly in line with the market (albeit inclusive of a premium for control). Equally, it is quite likely that both offerors factored in to their offers, some ability to enhance the performance of Brucejack.

Valuation Cross Checks

The valuation range for Brucejack implies the following valuation parameters:

BRUCEJACK – IMPLIED VALUATION PARAMETERS

	VARIABLE	IMPLIED MULTIPLE	
		LOW	HIGH
Valuation range (100% basis) (\$ millions)		3,000	3,300
Operating metrics			
FY23 EBITDA (actual) (times)	\$220 million	13.6	15.0
FY23 gold production (actual) (\$/oz)	286koz	10,490	11,538
Resources and reserves			
Gold resources (\$/oz)	12.2Moz	246	270
Gold reserves (\$/oz)	3.7Moz	811	892

Newcrest's \$2.8 billion acquisition of Pretivm in 2022 is the most relevant market benchmark in the valuation of Brucejack.

The FY23 earnings multiples are above the market evidence including including Kirkland Lake's acquisition of Detour Gold (9.5 times adjusted historical EBITDA and 8.2 times adjusted forecast EBITDA), which was materially larger than Brucejack (producing around 600koz gold per annum and had an estimated reserve life of over 20 years) and Agnico Eagle's acquisition of Yamana's Canadian assets (around 7 times historical EBITDA) where the remaining mine life at the Canadian Malartic joint venture was limited at only around five years (excluding potential mine extensions from exploration upside in the region). In part, this is attributable to the production halt during FY23 as well as the fact that FY23 does not reflect the full potential production ramp up.

Despite the lack of any other material by-product credits, Brucejack has very high resource and reserve multiples but this is consistent with:

- the multiples implied by the acquisition from Pretivm (resource and reserve multiples of \$271/oz and \$715/oz, respectively);
- the potential to convert resource to reserves (reserves are only 33% of resource);
- exploration potential (e.g. Gossan Hill and Golden Marmot); and
- other similar transactions (e.g. Agnico Eagle's acquisition of Yamana's Canadian assets) which had significant exploration upside in its surrounding region.

Annexure 1. Independent Expert's Report

GRANT SAMUEL



4.3.7 Wafi-Golpu

Summary

Grant Samuel has valued Newcrest's interest in the Wafi-Golpu project in the range \$420-525 million (excluding the share of consideration receivable from the State of PNG):

WAFI-GOLPU – VALUATION SUMMARY

	LOW	HIGH
Valuation range (100% basis) (\$ millions)	1,200	1,500
Newcrest interest in Wafi-Golpu for valuation purposes	35%	35%
Value of Newcrest's interest in Wafi-Golpu (\$ millions)	420	525

The valuation includes the Golpu development and the value attributed by AMC to any remnant resource (i.e. Wafi and Nambonga deposits). The valuation also takes into account the State of PNG's right to acquire up to a 30% interest in the project from Newcrest and Harmony Gold (or 15% from each joint venture participant) for a price equal to the pro-rata calculation of accumulated exploration expenditure (which is included in the valuation of Newcrest's other assets and liabilities, see Section 4.7).

Given the project's value accretive nature to the State of PNG, it is assumed that this option is exercised in full prior to the development of the mine (i.e. the State of PNG will be obliged to contribute its pro rata share of the project's development expenditure).

Accordingly, only 35% of the value of Wafi-Golpu has been included in the value analysis (although the operating assumptions have been prepared on a 100% basis).

Scenarios and Assumptions

The valuation is based on a scenario developed by AMC for Wafi-Golpu. Due to the project's current permitting stage and the expected time to development and first ore (i.e. at least five years), only one production scenario was prepared. All operating costs and capital expenditure are denominated in \$ (all costs are presented on a real FY23 basis).

The production scenario assumes that the Wafi-Golpu project (namely the Golpu mine) is developed and commissioned. It is premised on the following assumptions:

- total ore production of 400Mt over the life of mine, comprising:
 - 8Mt of development ore, with first ore in FY30;
 - 103Mt from BC43, which is mined from FY32 to FY41 (at an average head grade of 1.2 g/t gold and 1.8% copper); and
 - 289Mt from BC40, which is mined from FY39 to FY59 (at an average head grade of 0.8 g/t gold and 1.0% copper).

Production progressively ramps up to around 18Mtpa in FY39 but dips to under 9Mtpa in FY41 as mining operations transitions between the block caves, recovering thereafter to approximately 17Mtpa;

- ore milled gradually ramps up over seven years to reach approximately 17Mtpa. Recovery rates average around 68% for gold (albeit much higher in the first ten years of production) and 95% for copper over the life of mine to produce:
 - 7.6Moz of gold in concentrate over the life of mine (or around 260koz of gold per annum); and
 - 4.7Mt of copper in concentrate over the life of mine (or around 160ktpa of copper);



GRANT SAMUEL



- state royalties and mineral production levies of approximately 2.5% of revenue plus other royalties and recurring payments in relation to local compensation arrangements;
- cash operating costs of approximately \$22/t of milled ore over the project life;
- total capital expenditure of \$7.6 billion over the project life the majority of which is incurred as upfront investments for mine development and construction of the associated infrastructure (including to expand the capacity of the Watut processing plant following the commissioning of the project). Sustaining capital expenditure is approximately \$35 million per year; and
- income taxes payable according to the terms of the Wafi-Golpu MoU.

The following chart shows an aggregated production profile for Wafi-Golpu:

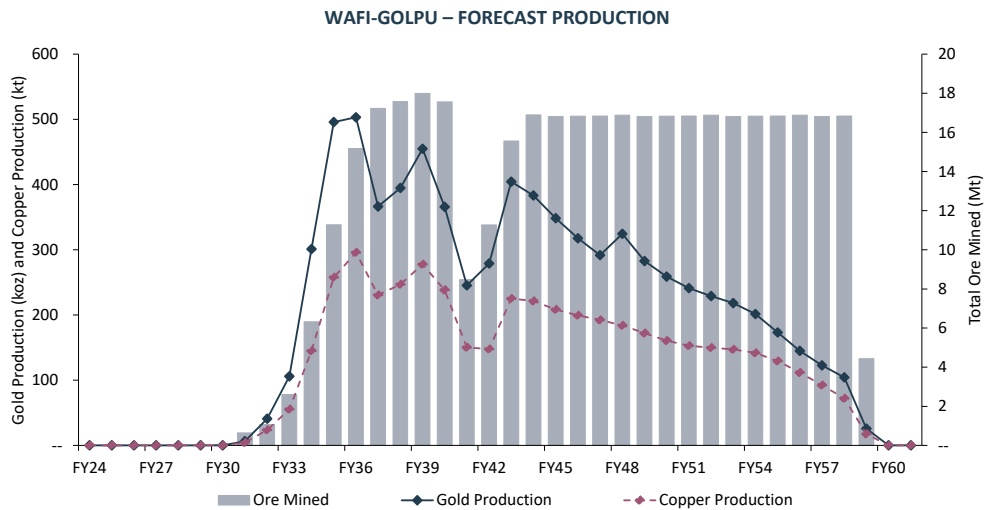

Source: AMC analysis

DCF Outputs and Valuation

The following table summarises the projected production and costs:

WAFI-GOLPU CORE OPERATIONS – MODEL PARAMETERS (100% BASIS)

	UNIT	FY27	FY28	FY29	FY30	FY31	LIFE OF MINE
Ore mined	Mt	-	-	-	0	1	400
Ore milled	Mt	-	-	-	-	0	400
Gold grade	g/t	-	-	-	-	0.74	0.87
Copper grade	%	-	-	-	-	1.14	1.23
Production							
Gold	koz	-	-	-	-	6	7,632
Copper	kt	-	-	-	-	4	4,652
Cash costs (real FY23 basis)	\$ millions	-	-	-	-	-	21.6
Capital expenditure (real FY23 basis)	\$ millions	209	571	681	1,519	1,156	7,626

The following chart aggregates the NPV outcomes for Wafi-Golpu (on a 100% basis) together with the value attributed by AMC to any remnant resource and exploration targets such as Wafi and Nambonga (albeit only approximately \$0.5 million). The estimated consideration from the State of PNG (based on the State exercising its option to the full 30% pro-rata calculation of accumulated exploration expenditure is included in Other Assets and Liabilities (Section 4.7):

Annexure 1. Independent Expert's Report

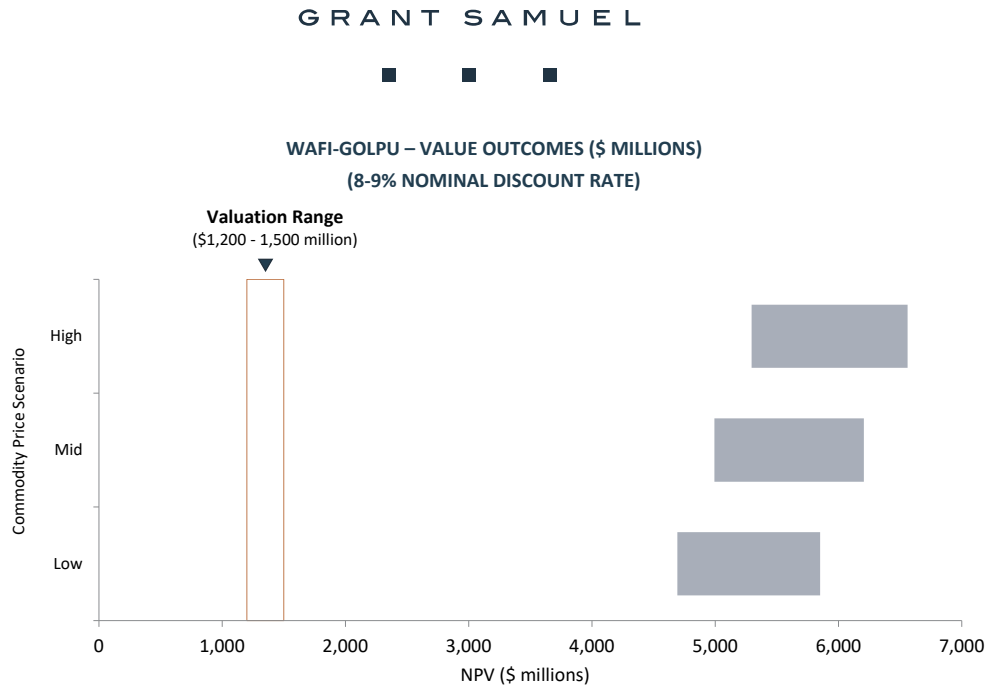

Grant Samuel's valuation range for Wafi-Golpu sits at a significant discount to the NPV outcomes. There are a number of reasons for this large discrepancy. The value outcomes illustrated above are based on the same risk free rate and discount rate range as Newcrest's producing mineral assets. However, it is necessary to discount these value outcomes as they do not fully capture the following factors in the cash flows:

- sovereign risk attached to investments in Papua New Guinea;
- development risk, as the project has yet to receive all necessary permits (including the Special Mining Lease) or a final investment decision; and
- project estimation risk, as the production and costing estimates are largely based on the latest feasibility study that was prepared in 2018 (adjusted only for inflation).

Mining of mineral resources such as gold is the subject of high political and social focus in Papua New Guinea. Accordingly, operating in the mining sector or developing a new mining project typically involves significant investment in government and stakeholder engagement (as demonstrated by the extensive consultation and approval process required to be granted a Special Mining Lease).

In most circumstances, a large part of the focus is on ensuring there are adequate benefits for the local stakeholders (e.g. landowners, local governments and provincial governments). This may take the form of economic benefits (e.g. royalties, taxes and other community levies) or social benefits (e.g. job creation, domestic procurement quotas, environmental protection). However, there can be disagreements between different levels of government and such conflict can cause delays in the project approvals.

In recent years, a number of political and regulatory events in Papua New Guinea have highlighted the risks of greenfield developments such as the Wafi-Golpu project. This includes:

- the proposal of a production sharing regime, which if implemented would result in the transfer of ownership of mineral assets from the State of PNG to state-owned enterprises who would be responsible for negotiating new mineral production sharing arrangements (which many industry participants feared may result in the government seeking a larger share of project revenue); and
- legal challenges to the permitting process for Wafi-Golpu. In recent years, the then Governor of Morobe Province filed two separate judicial review applications against the State of PNG:

G R A N T S A M U E L



- in January 2019, to challenge a prior memorandum of understanding between the State of PNG and the joint venture. This was dismissed by the National Court in February 2020 but the Governor has appealed the matter to the Supreme Court; and
- In March 2021, to challenge the granting of an environmental permit for the Wafi-Golpu project.

However, some of these issues that have hamstrung the project's development in the past appear to be easing. The election of a new Governor of Morobe has restored some goodwill between the joint venture and the local government. At the provincial executive council meeting where he was sworn into office in September 2022, the new Governor of Morobe acknowledged the importance of the project to the local community (particularly as a major source of revenue) and promised to withdraw the court cases filed by his predecessor³⁹. This support has continued during his term as he has been an active proponent of the project and participated in the signing ceremony for the Wafi-Golpu MoU.

The Wafi-Golpu MoU significantly improves the level of regulatory clarity over the project's development and is a major step forward to secure a Special Mining Lease. Key commercial terms including state equity participation, royalty rates and tax packages have been agreed in principle with the State of PNG. Given the project's scale and extensive infrastructure requirements (e.g. roads and pipelines, dedicated tailings pipeline, new port facilities, etc.), the State of PNG also recognises the significant social and economic contributions the project will bring to the surrounding communities.

The reality is, however, that a number of issues remain open and will need to be resolved. The Special Mining Lease and other relevant permits remain yet to be granted. Notwithstanding the verbal support from the new Governor of Morobe, separate negotiations still need to be held with landholders and provincial and local governments to determine agreeable compensation arrangements and distribution of benefits (which may impact the project's economics). An updated feasibility study will need to be completed before the Newcrest and Harmony boards can reach a final investment decision.

Moreover, there are only a handful of international gold producers in Papua New Guinea. Both Newcrest and Harmony Gold are known operators in the country with a track record of over 15 years (through Lihir and Hidden Valley, respectively) and would arguably have an established reputation within the country, particularly with national, state and provincial government representatives and local communities. The only other international gold producers in the country are Barrick Gold and Zijin Mining (Porgera mine) and St Barbara Limited (Simberi mine). A new project proponent or international investor will likely have to continue to maintain and progress the good relationships currently in place to ensure project development and permitting processes remains on track. To compound the challenges further, not many project proponents would necessarily have the risk appetite (or familiarity with the region) and funding capacity to dedicate a material upfront investment (estimated to be at least \$1 billion for a 35% interest in the project) in the country. These issues are likely to weigh on the value of Wafi-Golpu.

To put these risks into perspective, the NPV of Scenario 2 declines by approximately \$750 million (on a 100% basis) for every year the project is deferred or delayed.

The risks faced by Wafi-Golpu are undoubtedly greater than those faced by Lihir (which is an established mining operation with a long track record in the country). Accordingly, a subjective discount (from the NPV outcomes) would inevitably be larger for Wafi-Golpu. Taking these factors into consideration, Grant Samuel has estimated a valuation range of \$1,200-1,500 million (on a 100% basis and inclusive of the value of remnant mineral resources and exploration targets).

³⁹ Source: PNG Report, New governor says 'yes' to Wafi-Golpu, 8 September 2022.

Annexure 1. Independent Expert's Report

GRANT SAMUEL



Valuation Cross Checks

The valuation range for Wafi-Golpu implies the following valuation parameters:

WAFI-GOLPU – IMPLIED VALUATION PARAMETERS

	VARIABLE	IMPLIED MULTIPLE	
		LOW	HIGH
Valuation range (100% basis) (\$ millions)		1,200	1,500
Resources and reserves			
Gold resources (\$/oz)	27.2Moz	44	55
Gold reserves (\$/oz)	11.0Moz	109	136

In Grant Samuel's view, the implied multiples are reasonable although there is limited recent comparable transaction evidence available particularly for copper-gold projects of the size and scale of Wafi-Golpu.

The resource and reserve multiples implied by Grant Samuel's valuation of Wafi-Golpu are lower than the multiples implied by Grant Samuel's value range for any of its other mineral assets. This discount is primarily attributable to the non-operating status of the project (i.e. capital cost remains to be spent), the inherent uncertainty in its future development (i.e. arising from sovereign risks, project risks, funding risks) and the expected time horizon to the commencement of mining operations.

To put the implied multiples into context, the implied resource and reserve multiples for Wafi-Golpu are broadly aligned with the implied multiples for SolGold (which owns the Cascabel copper-gold project in Ecuador) and is trading at \$50/oz of gold resource and \$132/oz of gold reserves. There are a number of similarities between the two projects as both:

- are large scale copper-gold block cave projects that each support 25+ year mine lives;
- have significant required investment (estimated at nearly \$3 billion for each project) with first ore for both projects expected towards the end of the 2020s;
- are located in geographies that international investors may consider to be higher risk (see Section 4.6 for background on the sovereign risks attached to a gold project in Ecuador);
- remain subject to permitting and regulatory approvals. SolGold submitted its applications for a mining licence and revised investment protection agreement in 2022 and the outcomes from those processes are still pending; and
- are projects of significant value if successfully developed. The pre-feasibility for the Cascabel Project estimated NPVs of around \$2.9 billion (which is broadly comparable to the NPVs estimated under the original Wafi-Golpu feasibility study).

At the same time, caution is warranted in directly comparing these parameters in light of differences that may be weighing on the SolGold share price such as funding challenges and corporate governance concerns.

The implied resource and reserve multiples are towards the higher end of multiples paid for other large scale gold projects in recent years⁴⁰. The only transaction (of scale) that had substantially higher multiples was in near-production stage (i.e. Zijin Mining's acquisition of Continental Gold Inc., which owned Buriticá gold project in Colombia). This premium likely reflects Wafi-Golpu's scale and large copper endowment (which not many other gold projects of this scale share).

While there are clearly some limitations in relying on resource and reserve multiples in a valuation, in Grant Samuel's view, the market evidence is supportive of its valuation range for Wafi-Golpu.

⁴⁰ Source: S&P Global Market Intelligence, *Strategies for Gold Reserves Replacement: The costs of finding and acquiring gold*. Implied gold reserve multiples for transactions involving gold projects since 2018 range from as low as \$12/oz to \$275/oz.



GRANT SAMUEL



4.3.8 Review of Valuation Cross Checks

The implied valuation multiples for each of Newcrest’s mineral assets reflects their individual growth opportunities, risks and other characteristics that impact value. The implied valuation multiples (EBITDA, resource and reserve) are summarised in the charts below (the low end represented by the solid shaded column and the high end represented by the gradient stacked column):

NEWCREST MINERAL ASSETS – FY23 EBITDA MULTIPLES

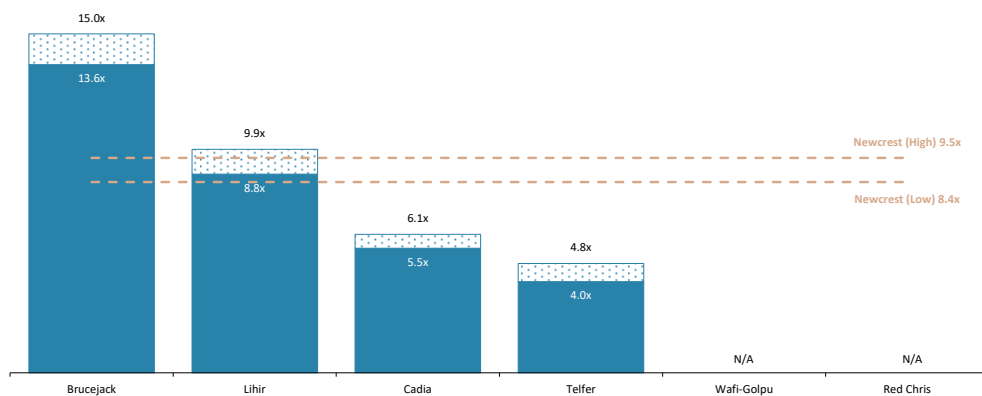

NEWCREST MINERAL ASSETS – GOLD-ONLY RESOURCE AND RESERVE MULTIPLES (\$/OZ)

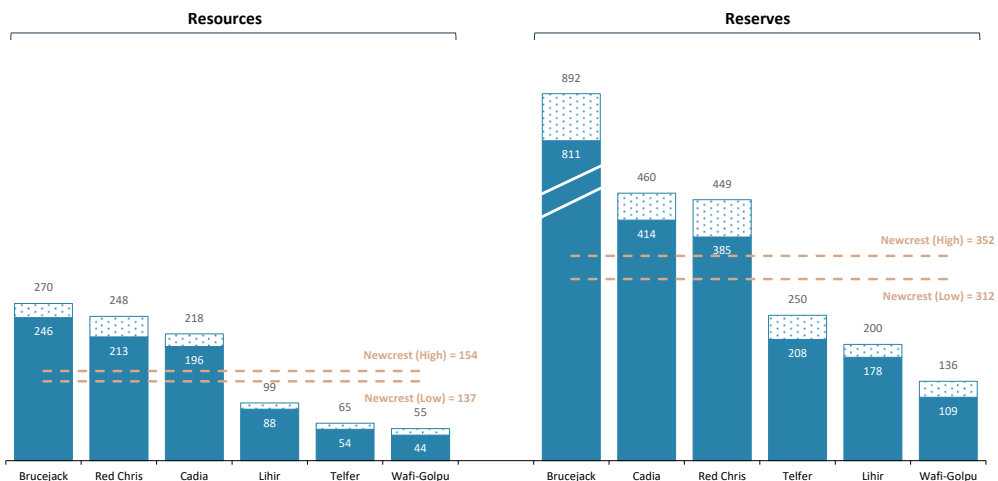

The implied EBITDA multiples sit across a very wide range and are bookended:

- at the top end by Red Chris, which can be considered an outlier as its EBITDA multiples are impacted by the low profitability of its current open pit mining operations and the earnings transformation that will occur from the block cave expansion (which is expected to unlock a material step-change in its production); and

Annexure 1. Independent Expert's Report

GRANT SAMUEL



- at the bottom end by Telfer, which is approaching the end of its mine life unless it successfully develops the Havieron project or adds new ore inventory to its existing underground mining operations.

While Cadia has the longest remaining reserve life amongst Newcrest's mineral assets, its relatively low EBITDA multiples reflects the lack of growth potential. Further expansions to its milling capacity (and copper and gold production rates) would inevitably require additional tailings storage facilities and permits which may not necessarily be guaranteed. On the other hand, the EBITDA multiples for Lihir and Brucejack reflect the near-term earnings upside at each of these sites (particularly at Lihir, which is expected to transition to the higher grade Kapit Zone and rectify some of its legacy operational challenges at the processing plant).

The resource and reserve multiples vary across an even wider range. However, the mineral assets at the top end of the range reflect the:

- resource-to-reserve conversion potential at Brucejack, for which the NPV analysis assumes that nearly all of the inventory will be extracted over its mine life (particularly for Scenario 2); and
- large copper endowments at Cadia and Newcrest. Revenue from copper sales can be a large contributor to value (approximately 50% of Cadia's revenue and up to 70% of Red Chris's revenue) but not included in the denominator (which is calculated on a gold-only basis).

On the other hand, those at the bottom end of the range reflect the individual risks that weigh on their value including sovereign risks (e.g. Lihir) and large upfront capital expenditure requirements or development risks (e.g. Telfer (inclusive of Havieron) and Red Chris). The very low resource and reserve multiples for Wafi-Golpu reflect the combination of both factors.

Taking all of these factors into consideration, Grant Samuel believes that the relativity of the multiples reflects a fair balancing of the issues impacting each of the mineral assets.

4.3.9 Sensitivity Analysis

The DCF valuations of each of Newcrest's mineral assets is subject to a number of key valuation assumptions that can have a material impact on value. The analysis in Sections 4.3.2 to 4.3.7 shows the impact of differences in some of these assumptions (commodity prices, exchange rates and discount rate).

However, to provide further guidance as to the sensitivity of the value outcomes for each of the mineral assets, the following table sets out the corresponding impact on Newcrest's NPV per share (assuming a midpoint WACC and the Mid Case commodity scenario) for 5% changes in key parameters:



GRANT SAMUEL



SENSITIVITY ANALYSIS – IMPACT ON NPV (\$ MILLIONS)

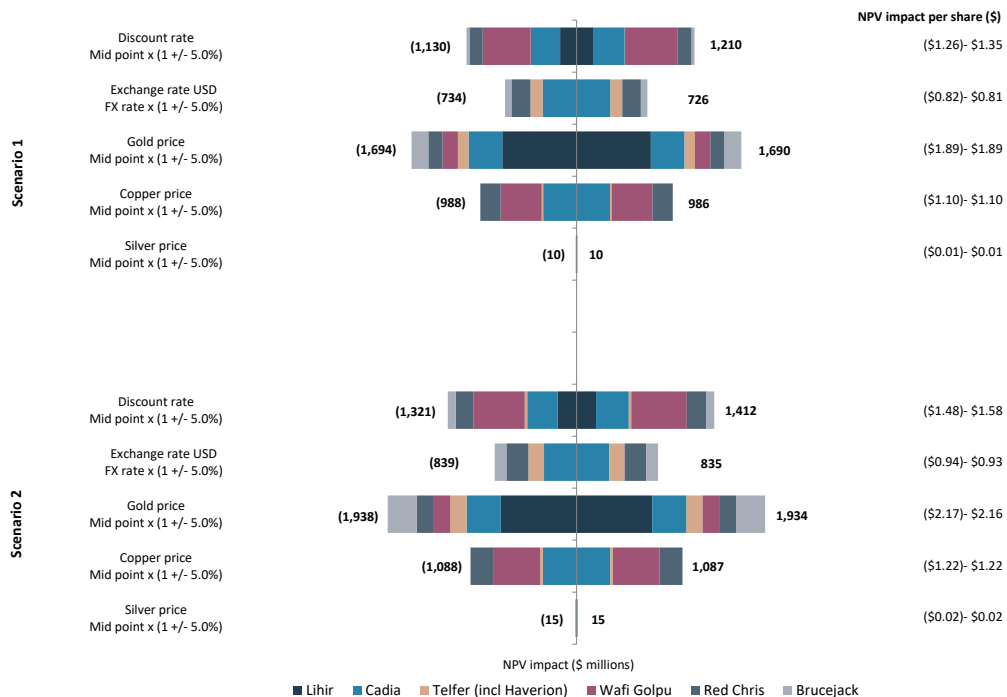

The change in NPV per share does not necessarily represent a change, if any, in the value per share estimated by Grant Samuel as the selected valuation range is not directly linked to any particular scenario but instead is based on an overall and subjective judgement based on different NPV outcomes (particularly across both Scenario 1 and 2) and market evidence (e.g. third-party, arms' length offers).

In relation to the table above:

- value outcomes for each of Newcrest's assets are highly sensitive to changes in commodity prices, particularly gold prices. This is principally driven by Lihir which only produces gold and is expected to represent in excess of 35% of total Newcrest gold production;
- changes in copper prices also have a substantial impact on the value of Cadia, Wafi-Golpu and Red Chris which are expected to derive 47%, 73% and 59% of total revenue from copper sales; and
- exchange rates also affect value as the cost bases of several assets are incurred in local currency (i.e. A\$ for Cadia and Telfer (inclusive of Haverion), and C\$ for Red Chris and Brucejack). The sensitivity analysis incorporates the resultant value impact on the translation of \$ revenue into A\$ or C\$ as well as the translation of A\$ values into \$.

Annexure 1. Independent Expert's Report

GRANT SAMUEL



4.4 Exploration and Development Assets

Grant Samuel has attributed value to Newcrest's unallocated exploration and development assets of \$86 million, based on the values recommended by AMC (see Section 9 of the AMC report at Appendix 7). Grant Samuel has adopted AMC's valuation range and allocated the exploration assets to the business units as summarised below:

NEWCREST – SUMMARY OF VALUES FOR REMNANT RESOURCE AND EXPLORATION ASSETS (ATTRIBUTABLE BASIS)

	REPORT SECTION REFERENCE	AMC SELECTED VALUATION RANGE (\$ MILLIONS)	
		LOW	HIGH
ALLOCATED REMNANT RESOURCE AND EXPLORATION ASSETS			
Cadia	4.3.2	401	526
Lihir	4.3.3	221	221
Telfer (inclusive of Havieron)	4.3.4	86	133
Red Chris	4.3.5	65	159
Brucejack	4.3.6	58	129
Wafi-Golpu	4.3.7	0.5	
Value of exploration and development assets (Newcrest share) (allocated)		833	1,168
UNALLOCATED REMNANT RESOURCE AND EXPLORATION ASSETS			
Namosi	Appendix 7	83	83
Other exploration assets in Australia, USA, Canada and Ecuador	Appendix 7	3	3
Value of exploration assets (Newcrest share) (unallocated)		86	86

The vast majority of the remnant resource and exploration value has been allocated to Newcrest's producing mining operations. The value of the remnant resource is partly driven by the remaining amount of mineral resource at the end of a project's mine life. Accordingly, the low end of the exploration and development assets valuation range represents the value of the remnant resource in the upside production scenario (i.e. Scenario 2) which would result in less remaining resource and a lower attributed value than in Scenario 1 (which is represented by the low end of the valuation range).

Most of Newcrest's assets have very long remaining lives but equally also have substantial resource bases. While the production cases considered in the DCF analysis contemplate mining lives generally in excess of 20+ years for each of these assets, this still leaves a large balance of remnant resource at the end of their respective lives. For example, Cadia is expected to have more than 2,000Mt of remnant resource (some of which are ore reserves). Lihir is also assumed to have more than 300Mt of remnant resource in each of its production cases.

On the other hand, the value of the exploration targets at each of these mineral assets are substantially smaller. The largest of these (by value) are in:

- Brucejack, which has undertaken an aggressive exploration program over the last eighteen months and has identified a number of exploration targets across the province; and
- Telfer (inclusive of Havieron), which includes the value of the joint ventures with Antipa (Wilki Joint Venture⁴¹) and Greatland (Juri Joint Venture) for exploration activities in the Paterson region.

No value has been attributed by AMC to the East Ridge exploration target at Red Chris as no mineral resource has been identified at this stage. The potential value upside has been considered in the overall valuation assessment for Red Chris (see Section 4.3.5).

⁴¹ The Wilki Joint Venture is currently an earn-in arrangement and the formal joint venture has not yet been established.

GRANT SAMUEL



The remaining unallocated value of exploration tenements and resources comprise Newcrest's exploration tenements across Australia, Canada, United States and the Asia Pacific. The largest of these is Newcrest's 73.03% interest in Namosi, which remains in very early study stages. The scale of the project (if developed) is substantial. It has over 7Mt of copper and 8Moz of gold in mineral resource (the majority of which is classified as indicated). At one point, some of these mineral resources were recognised as ore reserves. While a number of production plans have been developed over the years to assess economic ways to mine the deposit, none have advanced beyond the pre-feasibility stage and, in any event, the latest study in 2018 led to the de-recognition of the ore reserves due to the challenging infrastructure requirements (among other factors). Accordingly, the value of Namosi (based on AMC's "yardstick" approach) reflects the early stage nature of the asset; and

No value has been attributed to the exploration tenements for which Newcrest is a party to farm-in agreements but has not earned an interest at the date of this report. This includes the exploration targets in relation to the Gamora Project, Appaloosa Project, Mt Coolon and Headwater projects.

4.5 Corporate Costs

Newcrest incurs corporate overhead costs which represent costs associated with running Newcrest's head office and include:

- the Newcrest executive office (such as costs associated with the offices of the Chief Executive Officer and Chief Financial Officer, company secretarial and legal, strategy planning and development, corporate affairs, treasury, tax, etc.);
- being a publicly listed company (such as directors fees, annual reports and shareholder communications, share registry and listing fees and dividend processing);
- certain group shared services (such as human resources, information technology, etc.) and associated office infrastructure (e.g. depreciation expense on corporate and regional head offices); and
- share based payments, which are non-cash but reflect part of the total remuneration package for select executives and employees.

In FY23, Newcrest incurred unallocated corporate costs (excluding depreciation and equity-settled share-based payments) of \$108 million. These unallocated corporate costs exclude costs incurred by the head offices in Melbourne, Perth, Brisbane and Vancouver that are recharged to sites (and are included in the DCF analysis for each of Newcrest's mineral assets).

Any acquirer of Newcrest would be able to save the costs associated with being a listed company. Furthermore, an acquirer of Newcrest which has an existing presence in Australia or in Canada (particularly at or around the Golden Triangle province) would be able to eliminate many of the costs associated with the Newcrest head office and regional teams in Australia and Canada as they would already have comparable capabilities in place.

Grant Samuel has considered the appropriate level of cost savings from both a:

- bottom up approach, where, in conjunction with Newcrest management, an assessment has been made of the likely savings in each corporate cost category; and
- top down approach, which is based on the \$100 million in general and administrative cost savings that Newmont expects to achieve. Based on a discussion with Newmont management, Grant Samuel expects that a portion of these savings would be unique to Newmont and has assumed that approximately two-thirds of these cost savings (or \$68 million) would be available to any acquirer of Newcrest.

Grant Samuel has assumed that any acquirer would incur approximately \$45 million per annum of residual or incremental corporate costs. These costs include additional cost/capacity required for the larger

Annexure 1. Independent Expert's Report

GRANT SAMUEL



business, particularly in finance, insurance and information technology as well as government and industry relations spend (e.g. costs in relation to the regional corporate office in Papua New Guinea) and Newcrest's block caving expertise. Grant Samuel believes that the bottom up and top down approaches and the discussions with Newcrest and Newmont management provide a reasonable basis for its assessment of residual or incremental corporate cost of \$45 million.

Newcrest also incurs additional corporate capital expenditure primarily in relation to capitalised information technology spend. In Grant Samuel's view, any acquirer of Newcrest would have its own information technology infrastructure into which Newcrest (as the acquisition target) would be integrated. Consequently, Grant Samuel has assumed that the majority of corporate capital expenditure would be saved but has allowed for a small amount (\$2.5 million per annum) of additional ongoing capital expenditure associated with the information technology requirements of the retained head office personnel.

Grant Samuel has allowed for an amount of \$550-585 million, representing the value of these residual or incremental corporate costs (i.e. after allowing for the cost savings), in its valuation of Newcrest. This value is based on a DCF analysis over the life of Newcrest's mineral assets assuming a corporate tax rate of 30% and a (blended) discount rate of 7.5-8.0%. The amount of \$550-585 million implies a forecast EBIT multiple of ~13-14 times, which is considered reasonable having regard to the forecast EBIT multiples of Newcrest's peers.

4.6 Investments in Associates

Grant Samuel has valued Newcrest's investments in associates in the range \$950-990 million. The valuation assumptions for each of its investments are summarised below.

Investment in Lundin Gold (32% equity interest)

Grant Samuel has valued Newcrest's equity interest in Lundin Gold in the range \$880-920 million. This value range implies an equity value for 100% of Lundin Gold of \$2.8-2.9 billion and an enterprise value for Lundin Gold of \$2.9-3.0 billion⁴².

The starting point for Grant Samuel's valuation of Lundin Gold is the market value of the shares in Lundin Gold. A high level DCF analysis and multiples analysis (e.g. earnings, mineral resources and ore reserves) have been used to cross-check the value.

Relevant background factors include the following:

- Newcrest is the largest shareholder in Lundin Gold (with a 32% interest) and the Lundin family is the second largest shareholder (with a 27% interest);
- Lundin Gold has a free float of only around 40% of its total issued shares and limited liquidity which may result in the current share price not fully reflecting all currently available information and current market conditions⁴³;
- it is arguable that Newcrest may be able to exert a level of influence over Lundin Gold as, in addition to being its largest shareholder, Newcrest is entitled to nominate two directors to the Lundin Gold board. On the other hand, the Lundin family also has representation on the board (Jack Lundin is the Chairman of Lundin Gold) and Newcrest's board representatives are two out of a total of nine, which

⁴² Lundin Gold's implied enterprise value is calculated as 100% of the equity value plus Lundin Gold's net borrowings at 30 June 2023 of \$122 million. Net borrowings includes the book value of the Fruta del Norte finance facilities.

⁴³ Other investments in associates such as SolGold, Azucar, Antipa, Headwater and Metallic also have relatively low liquidity. Moreover, SolGold has a free float of under 65% due to the existing shareholdings of five separate substantial shareholders (including Newcrest). However, the aggregate market value of these investments are immaterial to the overall value of Newcrest (collectively less than 1%). Accordingly, Grant Samuel has relied on the market price of the shares for each of the associates as a proxy for value.

GRANT SAMUEL



does not give it the ability to unilaterally determine majority decisions (although it could block unanimous decisions); and

- Lundin Gold has only one producing asset, Fruta del Norte. The company holds a number of other mining concessions in the region surrounding the Fruta del Norte mine, but no mineral resources have been recognised for any of these concessions. Accordingly, it is reasonable to expect that the Fruta del Norte mine represents the vast majority of Lundin Gold's value. Furthermore, Lundin Gold has recently publicly released the Fruta del Norte Technical Report and three year guidance in relation to Fruta del Norte.

OBSERVATIONS ON SHARE PRICE AND MARKET RATING

The Lundin Gold share price at 30 June 2023 closed at C\$15.85 (equivalent to \$11.89). Since then, Lundin Gold shares have traded in the range C\$15.60-18.68 (equivalent to \$11.70-14.01) and closed at C\$16.20 on 31 August 2023. The current price of Lundin Gold shares is around its highest level in over ten years (post the global financial crisis) and reflects positive momentum following the commissioning of the Fruta del Norte mine in 2019 and its subsequent ramp-up:

LUNDIN GOLD – SHARE PRICE AND TRADING VOLUME

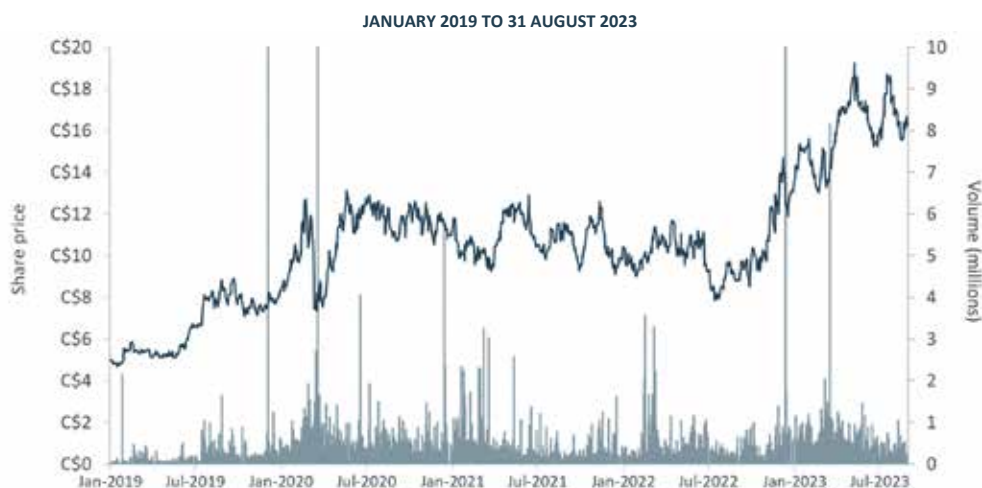

Source: Bloomberg

A degree of caution is warranted in relying on the current share price to assess the value of Newcrest's 32% equity interest in Lundin Gold because of Lundin Gold's limited free float. The two largest shareholders in Lundin Gold, Newcrest and the Lundin Family Trust, collectively represent nearly 60% of total issued shares, resulting in a free float of only around 40% of total issued shares. Consequently, there is reduced trading activity in Lundin Gold shares, with total turnover over the past 12 months representing approximately 35% of total average issued capital (or 58% of the free float). Other large gold producers generally have annual turnover in excess of 100% of average issued shares. This limited liquidity may result in the current share price not fully reflecting all currently available information and current market conditions.

The relative performance of Lundin Gold shares against the NYSE Arca Gold Miners index and gold spot prices from January 2023 is illustrated in the chart below:

Annexure 1. Independent Expert's Report

GRANT SAMUEL



LUNDIN GOLD VS NYSE ARCA GOLD MINERS INDEX VS GOLD SPOT PRICES

JANUARY 2023 TO 31 AUGUST 2023

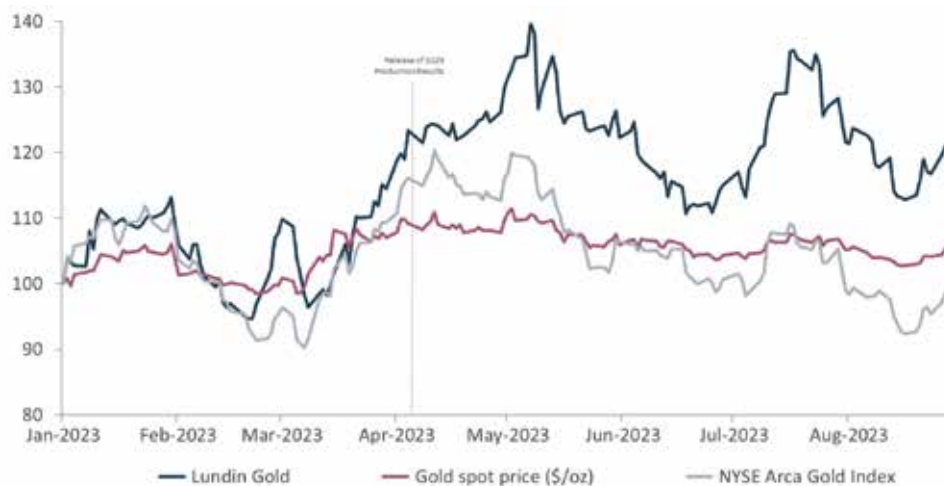

Source: Bloomberg

Movements in Lundin Gold shares have mostly mirrored movements in the NYSE Arca Gold Miners index and spot gold prices except for a period of outperformance in April and May 2023 following the company's strong 1Q23 operating results (announced on 5 April) that largely exceeded market expectations and underlined record grades and record gold production at the Fruta del Norte mine. Share price performance since May has trended in line with the two benchmarks.

Grant Samuel has also considered the trading EBITDA multiples of Lundin Gold relative to its peers:

LUNDIN GOLD VS COMPARABLE LISTED COMPANIES

HISTORICAL AND FORECAST EBITDA MULTIPLES

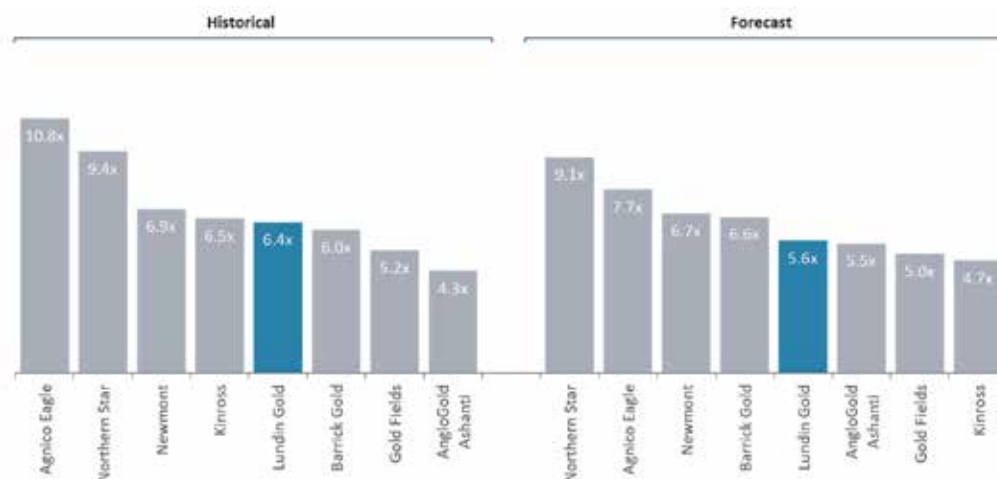

Source: Bloomberg

The implied EBITDA multiples for Lundin Gold are broadly in line with other listed major gold producers despite its substantially smaller size, high asset concentration and exposure to jurisdictional risk (the gold sector in Ecuador remains in its early stages). These factors are likely counterbalanced by other attractive

GRANT SAMUEL



characteristics (that support substantially higher implied gold resource and reserve multiples of approximately \$400/oz and \$680/oz, respectively, including the:

- scarcity of the asset, as Fruta del Norte is uniquely positioned as the only large scale producing gold mine in Ecuador, a largely unexplored (yet prospective) region despite the approval of new mining laws in 2013 to ease mining investment in the country;
- extremely high gold grades at Fruta del Norte (one of the highest grade mines in the world). The gold grades in mineral resource and ore reserve are substantially higher than Brucejack, Newcrest's highest grade gold mine;
- fully scoped mine plan, which is designed to extract nearly all the gold in ore reserves (and the vast majority of gold in mineral resources); and
- competitive cost profile, as Fruta del Norte is positioned in the lowest quartile of the global gold cost curve (with limited benefit from by-product credits).

These factors indicate that, despite Lundin Gold's limited free float and relatively low liquidity, it appears to be trading in line with its peers and the market.

ASSESSED MARKET VALUE

While Newcrest's 32% stake in Lundin Gold (the largest shareholder in the company) could be argued to command a strategic premium, the realisation of that premium depends on finding a party willing to pay such a premium and is likely to involve complex negotiations and an uncertain outcome. In Grant Samuel's view the better approach is to focus on the current market value as that reflects the readily realisable value at the current point in time.

The relatively large size of Newcrest's shareholding, which may mean that it is difficult to sell quickly or in one line and may restrict the price at which Newcrest is able to sell its interest. Block trade discounts typically range from 3-10%, with the size of the discount depending on the particular circumstances of each trade. In the case of Newcrest's shareholding in Lundin Gold, the large size of the shareholding (in terms of dollar amount and percentage of issued shares) and the lack of liquidity in the shares would usually indicate that a larger discount may be required.

Taking these factors into account, Grant Samuel has assessed a value range for Newcrest's 32% equity interest in Lundin Gold in the range \$880-920 million (rounded), based on its current market value (at the top end) and at a 5% discount to its current market value (at the low end), as summarised below:

LUNDIN GOLD – MARKET VALUE BASED VALUATION

	VALUE RANGE	
	LOW	HIGH
Lundin Gold price per share (C\$)	15.39	16.20
Exchange rate (C\$ to \$)	0.75	0.75
Lundin Gold price per share (\$)	11.54	12.15
Number of shares held by Newcrest (millions)	76.0	76.0
Value of Newcrest's 32% interest in Lundin Gold (\$ millions)	877	923

HIGH LEVEL DCF VALUATION CROSS-CHECK

The DCF valuation cross-check is based on a production case for Fruta del Norte's operations. The production case is based on publicly available information, including the summarised life of mine outputs set out in the Fruta del Norte Technical Report as well as Lundin Gold's guidance and outlook published on its website.

Annexure 1. Independent Expert's Report

GRANT SAMUEL



Due to the lack of access to non-public information from Lundin Gold, the operating assumptions have not been reviewed by AMC.

A single production case has been used for the purposes of the valuation cross-check. While the guidance presents a low scenario and high scenario, these scenarios only run for three years through to CY25 and would have an immaterial impact on the value of Lundin Gold.

The analysis adopts the key operating assumptions set out in the Fruta del Norte Technical Report and the upper end of the guidance released by Lundin Gold. The key valuation assumptions are summarised below (all costs are presented in real CY23 basis):

- total ore mined of approximately 18Mt over the remaining life of mine (at approximately 1.6Mtpa through to CY29 before gradually stepping down over the next five years to CY34);
- total ore milled equals total ore mined (at an average mill rate of 1.6Mtpa) to produce either gold doré or gold concentrates collectively containing:
 - gold metal of around 4.4Moz over the life of mine as head grades average nearly 9 g/t over the life of mine (declining from around 10 g/t in the first three years of production to 7 g/t in the latter years) and recovery rates remain at approximately 90% over the life of mine; and
 - silver metal of 5.3Moz over the life of mine.

Accordingly, annual gold production is approximately 475koz in CY23, 500koz in CY24 and 515koz in CY25 before gradually declining to 350koz per annum for the remaining years. Half of gold production is sold to Newcrest as gold doré under the offtake agreement (representing 50% of gold production). The remainder is sold as gold concentrates;

- payable factors of 100% for contained gold in gold doré and 96% for contained gold in concentrate (and 90% for contained silver);
- total cash operating costs of approximately \$15/tonne milled over the life of mine (including mining and milling costs, site overheads and services costs, treatment and refinery charges and royalties);
- rehabilitation costs of approximately \$23 million at the end of the mine life in CY35;
- total capital expenditure of \$270 million over the life of mine (around \$20 million per annum in CY26 onwards following higher sustaining capital requirements in CY24 and CY25);
- corporate and administrative expense of \$20 million per annum; and
- an income tax rate of 22% (a reduced income tax rate agreed under Lundin Gold's *Investment Protection Agreement* with the Government of Ecuador).

The following chart summarises the NPV outcomes for Fruta del Norte (on a 100% basis):



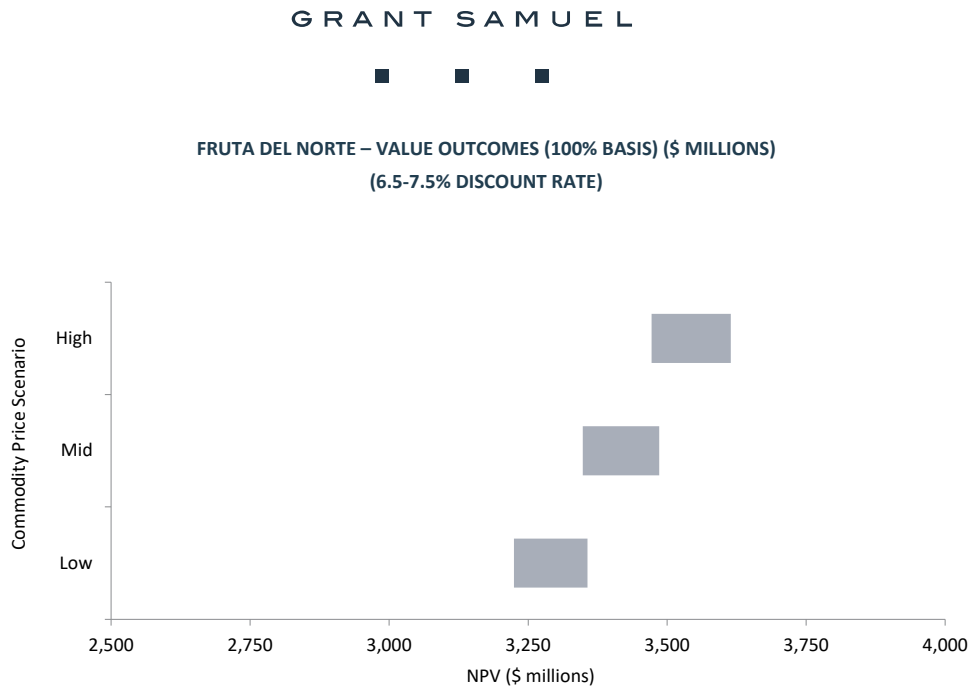

The NPV outcomes have a reasonable level of confidence reflecting:

- the high degree of certainty associated with the extraction of Fruta del Norte's ore inventory. The life of mine plan is premised solely on the extraction of gold and silver from the existing ore reserves and does not factor in any incremental ore from future potential reserve conversion although Lundin Gold's recent exploration track record in the area has demonstrated its ability to successfully replace ore reserves mined to date; and
- the track record of performance, as the mine has been in operation for nearly three years and has consistently produced over 400koz in each of CY21 and CY22 (and remains on track to meet, or even exceed, guidance in CY23).

However, the NPV outcomes:

- also reflect some of the theoretical underpinnings of a DCF analysis, including control over the business operations (i.e. strategic direction and use of capital) and full access to cash flows, which Newcrest does not have;
- do not include any allowance for mineable resources beyond the mine plan; and
- do not explicitly take into account sovereign risk as the value outcomes are based on the same discount rate range (i.e. 5-7%) as the rest of Newcrest's mineral assets. While Ecuador has become more attractive as a jurisdiction for mining investment in recent years⁴⁴, the combination of political uncertainty and fiscal issues continues to weigh on the country, where the sovereign credit is sub-investment grade and bond yields remain elevated. This sovereign risk is arguably already reflected in Lundin Gold's share price.

Nevertheless, the NPVs are close enough to the Enterprise Value implied by the share price (\$3.0 billion) to give confidence in the efficacy and reliability of the market price as a basis for valuation.

⁴⁴ Source: Fraser Institute, Annual Survey of Mining Companies 2021.

Annexure 1. Independent Expert's Report

GRANT SAMUEL



Other Investments in Associates

Grant Samuel has valued Newcrest's other investments in associates (i.e. SolGold, Antipa, Azucar, Headwater and Metallic) at \$70 million based on the market value of each of the listed companies (utilising the share prices on their respective primary listing).

4.7 Other Assets and Liabilities

The vast majority of Newcrest's other assets represents the Fruta del Norte finance facilities, which have been valued in the range \$492-562 million. This value includes the:

- SCFA, which has been valued using a DCF analysis. In April 2020, Newcrest acquired a \$150 million facility, which allowed it to receive monthly cash payments from Lundin Gold that are tied to the gold and silver production at Fruta del Norte. The payments are subject to a cumulative gold production volume cap which is expected to be reached within the life of mine (as set out in the Fruta del Norte Technical Report).

The valuation of this finance facility is not straightforward:

- Lundin Gold has two separate options exercisable on 30 June 2024 and 30 June 2026. Exercising the options will reduce the monthly repayments but will require Lundin Gold to make one-off payments to Newcrest of \$150 million and \$225 million, respectively. The value of the finance facilities is capped at the total value of these one-off payments (allowing for taxes and present value adjustments);
- exercising the options is ultimately dependent on Lundin Gold's view on long-term gold prices. Current gold price outlooks have no bearing on Lundin Gold's future decisions but can still be helpful in assessing the likelihood of these decisions based on information available and known to-date and assess value of the finance facility today; and
- the remaining mine life of the Fruta del Norte mine at or around the time of the option exercise dates would also influence Lundin Gold's decision. The current mine plan assumes that the stream payments in relation to gold production will be fully consumed within the mine life. Changes to the mine plan such as a material reduction in expected production from that currently envisioned or major deferrals in near-term operations which pushes out the production profile to beyond 2026. However, there is no basis to pre-empt any changes to the mine plan in the absence of information (nor is it commercially practical for a potential buyer of the finance facility to do so).

There is evidence that Lundin Gold has a positive outlook on gold prices (at least in the near term). Under the GPCA, Lundin Gold was required to make quarterly cash payments that were calculated with reference to spot gold prices through 30 June 2025. Lundin Gold elected to fully prepay the GPCA in January 2023 to eliminate this exposure. At the same time, there is no guarantee that Lundin Gold will continue to maintain this outlook at each of the future option payment dates.

Moreover, there is a clear focus by Lundin Gold to strengthening its balance sheet. In its June 2023 Investor Day presentation, the company highlighted the different options it had to consolidate its legacy project financing package, including accelerating senior debt repayments and exercising its option on the SCFA.

While there is no scientific approach to account for these issues, a sensitivity analysis on key assumptions (particularly gold and, to a lesser extent, silver prices) can be a helpful tool in understanding the thresholds for which Lundin Gold will elect to make the future one-off payments. Based on current gold prices and the expected savings attributable to Lundin Gold if it exercises the options, Grant Samuel has assumed that Lundin Gold will likely exercise the first option in 30 June 2024 but keep the SCFA on foot until the remaining balance is fully repaid; and



GRANT SAMUEL



- offtake agreement, which is valued using a DCF analysis based on Newcrest's expected margins (i.e. gold realised price less recovery losses, refinery costs and transport charges). Newcrest is assumed to fully utilise its entitlement under the agreement (i.e. 2.5Moz gold).

The SCFA accounts for most of the value of the Fruta del Norte finance facilities. No value was attributed to the GPCA (as the facility was fully repaid in January 2023). At the low end the value is in line with the book value at 30 June 2023 (Newcrest \$300 million, Lundin Gold \$305 million) both of which were calculated on a fair value basis. The high end recognises that there is upside value if current gold prices are adopted in the valuation.

The remainder of the other assets represent:

- a loan to Greatland in relation to the Havieron Project. The loan was used to fund Greatland's share of early works and drilling activities in the project and is repayable from a portion of the net proceeds from its share of production at Havieron;
- consideration receivable from the PNG Government under the assumption that it will elect to exercise the option to purchase up to 30% equity interest in Wafi-Golpu, at a pro rata share of accumulated exploration expenditure. The high end assumes a payment equal to Newcrest's estimates of accumulated cost as defined by the agreement. The low end allows for a degree of uncertainty as the sum has not yet been agreed with the PNG Government or subject to audit/verification; and
- deferred consideration in relation to the sale of the Gosowong mine in 2020. The outstanding balance remains payable.

Newcrest has a number of other assets and liabilities on its balance sheet that have not been included in other assets and liabilities for the following reasons:

- provisions for mine rehabilitation (e.g. dismantling and removal of structures and operating facilities, closure of tailings and waste sites and restoration and other reclamation and restoration activities) have been included in the cash flow models used for the DCF analysis for each respective mineral asset;
- tax losses have been included in the cash flow models used for the DCF analysis and have therefore not been separately valued; and
- costs in relation to fuel hedging and power purchase agreements (e.g. Cadia renewable power purchase agreement) have been included in the cash flow models used for the DCF analysis.

4.8 Adjusted Net Borrowings

Newcrest's adjusted net borrowings for valuation purposes are \$1,531 million. This amount represents Newcrest's net borrowings (excluding leases) at 30 June 2023 adjusted for the final FY23 dividend payment of \$0.20 per share and the cash settlement of equity incentives that exceed existing treasury shares^{24,45}. Lease payments have been excluded from net borrowings as they are included in the cash flows used in the DCF analysis (including any extensions as equipment is renewed or replaced).

No adjustment has been made for:

- capitalised borrowings costs as these have been recorded as a prepayment in Newcrest's balance sheet (and not a deduction from net borrowings); and
- the special dividend of \$1.10 per share as the valuation of Newcrest has been prepared on a "cum dividend" basis (i.e. before payment of the dividend).

⁴⁵ Calculated as 2,814,919 equity incentives less 2,626,117 treasury shares to give a shortfall of 188,802 equity incentives, cash settled at the assessed value of the consideration of \$17.10 to \$18.70 per Newcrest share.

GRANT SAMUEL



4.9 Franking Credits

Under Australia's dividend imputation system, domestic equity investors receive a taxation credit (franking credit) for tax paid by a company. The franking credit attaches to any dividends paid by a company and the franking credit offsets personal tax for Australian investors. To the extent that personal tax has been fully offset the individual will receive a refund of the balance of the franking credit. Franking credits therefore have value to the recipient.

However, in Grant Samuel's opinion, while acquirers are attracted by franking credits there is no clear evidence that they will actually pay extra for a company with them (at any rate the sharemarket evidence used by Grant Samuel in valuing the Newcrest businesses will already reflect the value impact of the existence of franking credits). Further, franking credits are not an asset of the company in the sense that they can be readily realised for a cash sum that is capable of being received by all shareholders. The value of franking credits can only be realised by shareholders themselves when they receive distributions. Importantly, the value of franking credits is dependent on the tax position of each individual shareholder. To some shareholders (e.g. overseas shareholders) they may have very little or no value. Similarly, if they are attached to a distribution which would otherwise take the form of a capital gain taxed at concessional rates there may be minimal net benefit (in fact, there may be some categories of shareholders who are worse off in this situation such as shareholders with a capital loss on disposal of the shares).

Accordingly, while franking credits may have value to some shareholders they do not affect the underlying value of the company itself. No value has therefore been attributed to Newcrest's accumulated franking credit position in the context of the value of Newcrest as a whole.

In any event, following payment of the special dividend of \$1.10 per share³ and the FY23 final dividend of \$0.20 per share, Newcrest will have minimal franking credits available.



GRANT SAMUEL



5 Profile of Newmont

5.1 Overview

Background

Newmont was founded in 1916⁴⁶ as a holding company for investment in global mineral and oil companies, including a founding 25% interest in gold miner Anglo American Corporation (South Africa). Renamed as Newmont Mining Corporation, it has publicly traded (on an informal exchange) since 1925 and has been listed on the NYSE since 1940.

Over the following decades, Newmont acquired numerous lead, zinc, gold and copper assets as well as coal and oil and gas assets (including the acquisition of an initial 27.5% interest in Peabody Holding Company ("Peabody") in 1977). Newmont subsequently returned its focus to gold with the discovery of the Carlin Trend in Nevada in the United States and the commencement of gold exploration in Western Australia (culminating in the discovery of the Telfer deposit which was jointly developed by Newmont and BHP Gold). By the 1970s, Newmont was in the process of transforming from a holding company to an operating company.

During the 1980s, Newmont defended multiple takeover offers seeking to break up the company and sell its assets to increase shareholder value. In early 1987, to release cash, Newmont listed its Australian gold operations on the ASX as Newmont Australia (retaining a majority (75%) interest) and also sold a minority (~10%) interest in its Carlin Trend gold operations through listing on the NYSE what was ultimately called Newmont Gold Company.

In September 1987, as part of a takeover defence, Newmont paid a partially debt funded \$33 per share dividend to shareholders totalling \$2.2 billion. To reduce debt in the aftermath of the October 1987 stock market crash, Newmont undertook a major restructuring resulting in the divestment of all of its copper, oil and gas and coal interests. Following the sale of its 55% interest in Peabody in 1990, Newmont became a pure gold company.

Since 1990, Newmont has grown its gold operations through a series of mergers and acquisitions globally, including the:

- 1990 merger of Newmont Australia with BHP Gold to create Newcrest, Australia's largest pure play gold company with a market capitalisation at the time of around A\$1.2 billion (completed in January 1991). Newcrest's key asset was 100% ownership of the Telfer Mine (which was previously 70% owned by Newmont Australia and 30% owned by BHP Gold). Following the merger, Newmont held a 14% interest in Newcrest (although this interest was sold down in 1993);
- 1996 hostile takeover of Santa Fe Pacific Gold Corporation, substantially increasing production, reserves and acreage in Nevada;
- merger of Newmont Mining Corporation and Newmont Gold Company in 1998 (by Newmont Mining Corporation acquiring the 6.25% of Newmont Gold Company that was publicly owned at the time) to form a global gold company;
- \$667 million scrip acquisition of Battle Mountain Gold Company completed in 2001 (which consolidated strategic land positions in Nevada);
- 2002 scrip acquisition of Normandy Mining Limited (Australia) and its ~20% shareholder, Franco-Nevada Mining Corporation (Canada) for a total of \$4.7 billion to become the world's largest gold producer (with annual production of over 8Moz);

⁴⁶ Newmont was founded in 1916 as Newmont Company but reincorporated as Newmont in 1921.

Annexure 1. Independent Expert's Report

GRANT SAMUEL



- C\$1.5 billion acquisition of Miramar Mining Corporation, which owned the Hope Bay project in the Canadian Arctic, one of the largest undeveloped gold deposits in the world, in 2008;
- 2009 acquisition of the remaining 33.33% interest in the Boddington project (Western Australia) (the largest gold project in Australia) from AngloGold Ashanti Ltd ("AngloGold Ashanti") to take its ownership to 100%. The acquisition price was \$990 million in cash and scrip (including a deferred component) as well as a royalty capped at \$100 million;
- 2011 acquisition of Fronteer Gold Inc. (Canada), which had development assets close to Newmont's Nevada operations, for C\$2.3 billion;
- 2015 acquisition of the Cripple Creek & Victor gold mine in Colorado from AngloGold Ashanti for \$820 million plus a 2.5% net smelter return royalty on potential future gold production from underground ore;
- \$10 billion scrip acquisition of Goldcorp Inc. ("Goldcorp") (Canada) in 2019, which combined two gold sector leaders to create an unmatched portfolio of operations, projects, exploration opportunities and reserves in the global gold mining sector. Goldcorp had assets in North America and South America, including the tier 1 gold assets, Peñasquito (in Mexico) and 40% joint venture interest in Pueblo Viejo (in the Dominican Republic);
- creation of a joint venture with Barrick Gold in 2019, combining their respective mining operations, assets, reserves and talent in Nevada ("Nevada Gold Mines"), allowing the joint venture parties the opportunity to capture an estimated \$500 million in average annual pre-tax synergies in the first five full years of the combination. Nevada Gold Mines is the world's single largest gold producer, with a pro forma annual production of more than 4Moz, three tier 1 assets and 48Moz of reserves. Nevada Gold Mines is 38.5% owned by Newmont and is operated by Barrick Gold; and
- acquisition of the remaining 48.65% interest in Yanacocha in Peru in 2022 (via two transactions), to take it to full equity ownership.

Today, Newmont is the largest gold producer in the world with a global portfolio of assets and a market capitalisation of around \$31 billion.

Mineral Assets

Newmont is primarily a gold mining company although a number of its gold assets also contain copper, silver, lead, zinc or other metals. It owns a portfolio of 14 producing assets (including one majority owned and two joint ventures) and eight development projects (including four joint ventures) across the United States, Canada, Mexico, the Dominican Republic, Peru, Suriname, Argentina, Chile, Australia and Ghana. Its producing assets include eight tier 1 gold assets — Nevada Gold Mines (in the United States), which includes three tier 1 assets, Goldstrike/Carlin, Cortez and Turquoise Ridge/Twin Creeks, Pueblo Viejo (in the Dominican Republic), Peñasquito (in Mexico), Ahafo (in Ghana) and Boddington and Tanami (in Australia).

Newmont also undertakes exploration, with a focus on near-mine expansion programs (~80% of exploration expenditure) and, to a lesser extent, advancing greenfield projects (~20% of exploration expenditure).

The following map shows the location of Newmont's mineral assets:



GRANT SAMUEL



NEWMONT – LOCATION OF MINERAL ASSETS



Barrick Gold is Newmont's joint venture partner in Nevada Gold Mines (where it owns the remaining 61.5% interest and is the operator), the Pueblo Viejo joint venture (where it owns a 60% interest and is the operator) and the Norte Abierto joint venture (where it owns a 50% interest).

Teck Resources Limited ("Teck Resources")⁴⁷ is Newmont's joint venture partner in the Galore Creek and the Nueva Unión joint ventures (where it owns a 50% interest in each joint venture).

Newmont acquired a 50% interest in the Noche Buena gold/silver exploration project⁴⁸ as part of its acquisition of Goldcorp in 2019. The Noche Buena exploration project had been acquired by Goldcorp as part of its acquisition of Peñasquito (when Goldcorp acquired Canplats Resources Corporation in 2010).

Newmont owns a 75% interest in Suriname Gold project C.V ("Merian") with the remaining 25% interest owned by Staatsolie Maatschappij Suriname N.V. ("Staatsolie"), a company wholly owned by the Republic of Suriname.

Construction activities at Conga were suspended in 2011 at the request of Peru's central government following protests by anti-mining activists. Newmont reclassified Conga's reserves to resources in 2016 as a result of certain operating and construction permits expiring at the end of 2015. Newmont has subsequently prioritised other projects ahead of the Conga project and does not anticipate developing the Conga project in the next 10 years. As a result, the Conga project is currently in care and maintenance.

A description of each of Newmont's key assets is set out in Section 6.2 of the Scheme Booklet.

⁴⁷ Teck Resources is a diversified natural resources company focused on copper, zinc and steelmaking coal across Canada, the United States, Chile and Peru. It has been subject to a number of acquisition proposals from Glencore plc in 2023 which have been rejected by the Teck Resources board.

⁴⁸ Newmont previously acquired a 44% interest in the Noche Buena operating mine as part of a joint venture with Fresnillo plc ("Fresnillo") that was established in 2008. Newmont sold its 44% interest in the joint venture to Fresnillo in 2014. The current 50% interest relates to a different exploration/development project.

Annexure 1. Independent Expert's Report

GRANT SAMUEL



Newmont produces:

- gold doré bars (consisting primarily of gold but also containing silver and other metals), which are sent to refiners to produce gold bullion that meets the required market standard of 99.99% gold. Under the terms of Newmont's refining agreements, the doré bars are refined for a fee, and its share of the refined gold and the separately recovered silver is credited to its account or delivered to buyers;
- co-products⁴⁹ in the form of copper concentrate (from Boddington) and silver, lead and zinc concentrate (from Peñasquito), which are sold to smelters located in Asia, North America, and Europe for further processing. A portion of gold sold from Peñasquito and Boddington is sold in a concentrate containing other metals such as copper, silver, lead and/or zinc; and
- by-products⁴⁹ in the form of copper and silver produced at other Newmont sites and joint ventures.

Due to London being the most important gold trading centre globally, the majority of Newmont's revenue is attributable to gold bullion sales into United Kingdom markets:

NEWMONT – CONTRIBUTION TO CY22 NET REVENUE

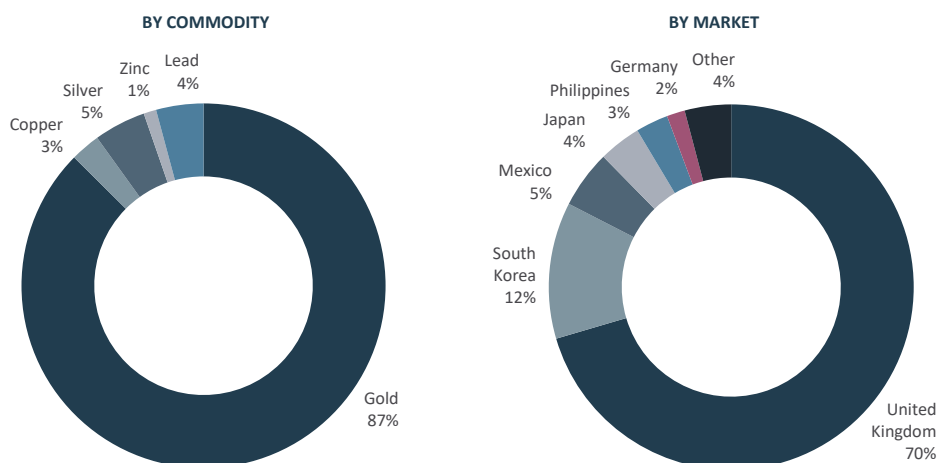

Source: Newmont

Gold bullion is sold through numerous gold market traders and banking counterparties globally. Consequently, Newmont is not economically dependent on any particular customer for the sale of its product. However, established customer relationships in individual markets means that customer concentration is moderate. In CY22, sales to Newmont's two largest customers represented just under 50% of total gold sales (35% to Standard Chartered and 13% to JPMorgan Chase). These two customers have represented around 50% of Newmont's total gold sales for the past five years.

Silver, lead, zinc and copper concentrates are sold and exported to smelters under a combination of short-term and long-term supply contracts with processing fees based on the demand for these concentrates in the global marketplace.

⁴⁹ Generally, if a metal expected to be mined represents more than 10-20% of the life of mine sales value of all the metal expected to be mined, the metal is considered a co-product and recognised as sales in the financial statements. If a metal expected to be mined falls below the co-product sales value percentages, the metal is considered a by-product. Revenues from by-product sales are recognised as a credit to costs applicable to sales in the financial statements.

GRANT SAMUEL

**Reserves and Resources**

Newmont's gold operations are supported by the long reserve lives at its tier 1 assets. It has an operating reserve life of more than 10 years at six managed sites and two non-managed joint ventures, with upside potential from its organic project pipeline. Its two largest assets, Nevada Gold Mines (38.5% interest) and Boddington, have estimated reserve lives of 15+ years and 13+ years, respectively. Newmont's reported mineral resources and ore reserves across key commodities are summarised below:

NEWMONT – REPORTED RESOURCES AND RESERVES AT 31 DECEMBER 2022 (ATTRIBUTABLE BASIS)⁵⁰

ASSET	TYPE ⁵¹	TOTAL RESOURCES			TOTAL RESERVES		
		GOLD (MOZ)	COPPER (MLB)	SILVER (MOZ)	GOLD (MOZ)	COPPER (MLB)	SILVER (MOZ)
NORTH AMERICA							
Nevada Gold Mines (38.5%)	O	37.8	740	31.5	18.6	320	13.3
Cripple Creek & Victor	O	3.3	-	-	1.6	-	-
Musselwhite	O	2.8	-	-	1.9	-	-
Porcupine	O	9.6	-	-	2.3	-	-
Éléonore	O	2.5	-	-	1.6	-	-
Peñasquito	O	9.1	-	660.0	5.4	-	346.1
Noche Buena (50%)	D	0.2	-	9.5	-	-	-
Coffee	D	2.4	-	-	-	-	-
Galore Creek (50%)	D	5.4	6,770	97.0	-	-	-
Total North America		73.1	7,510	798.0	31.3	320	359.4
SOUTH AMERICA							
Conga	D	17.5	4,920	52.2	-	-	-
Yanacocha	O	13.9	2,680	150.2	5.8	1,530	86.8
Merian (75%)	O	6.5	-	-	3.9	-	-
Cerro Negro	O	4.8	-	29.2	3.0	-	19.5
Pueblo Viejo (40%)	O	10.3	-	62.7	8.2	-	51.0
NuevaUnión (50%)	D	10.5	18,330	88.1	5.1	9,800	47.2
Norte Abierto (50%)	D	26.8	6,980	64.2	11.6	2,890	29.3
Total South America		90.3	32,910	446.9	37.6	14,220	233.8
AUSTRALIA							
Boddington	O	15.2	1,820	-	10.6	1,160	-
Tanami	O	9.8	-	-	5.7	-	-
Total Australia		25.0	1,820	-	16.2	1,160	-
AFRICA							
Ahafo South	O	10.8	-	-	5.7	-	-
Ahafo North	D	5.2	-	-	3.8	-	-
Akyem	O	3.2	-	-	1.5	-	-
Total Africa		19.2	-	-	10.9	-	-
Total Newmont		207.6	42,240	1,244.8	96.1	15,710	593.1

Source: Newmont and Grant Samuel analysis

At 31 December 2022, Newmont had gold reserves of 96.1Moz at an average reserve grade of 1.09g/t. Over 90% of Newmont's gold reserves are in tier 1 jurisdictions, with the majority of its ore reserves (and mineral resources) attributable to its operating mines in South America and North America (including its

⁵⁰ Mineral resources are inclusive of mineral reserves. This is consistent with Newcrest's disclosure of resources but differs from Newmont's disclosure where resources are reported exclusive of reserves and only provides an approximation of reserves inclusive of resources. Newmont's disclosure of reserves and resources are reported under Subpart 1300 and are not reported in accordance with the JORC Code (see Sections 6.2 and 11.11 of the Scheme Booklet for details). Figures represent Newmont's interest in resources and reserves. Numbers may not add due to rounding. Tier 1 assets are shaded in orange.

⁵¹ Type of asset is either operating mine ("O") or development project ("D").

Annexure 1. Independent Expert's Report

GRANT SAMUEL



38.5% interest in the Nevada Gold Mines joint venture which is its largest mineral asset by a considerable margin).

Newmont has a significant exposure to:

- copper, with 15.7 billion pounds in reserves at 31 December 2022, primarily at its 50% joint venture interests in NuevaUnión and Norte Abierto in South America (acquired as part of the Goldcorp acquisition in 2019); and
- silver, with 593.1Moz in reserves at 31 December 2022, primarily through the mineral assets acquired as part of the Goldcorp acquisition.

Newmont's reported mineral resources and ore reserves also include other metals such as lead and zinc at Peñasquito and molybdenum at NuevaUnión but these are relatively immaterial in the context of Newmont's overall mineral resources and ore reserves.

Key projects in Newmont's development pipeline include:

- *Tanami Expansion 2* (Australia), extending the Tanami mine life beyond 2040 through the addition of a 1,460m hoisting shaft and supporting infrastructure to process 3.3Mtpa of ore, increase average annual gold production by approximately 150-200koz per year for the first five years and reduce operating costs by approximately 10% (an AISC of \$900-1,000/oz);
- *Ahafo North* (Africa), expanding the existing footprint in Ghana with four open pit mines and a standalone mill located approximately 30km from the Ahafo South operations, adding 275-325koz of gold per year with an AISC of \$800-900/oz for the first five full years of production;
- *Pamour* (North America), optimising mill capacity to extend the life of Porcupine and maintaining production beyond 2024;
- *Cerro Negro District Expansion 1* (South America), simultaneous development of the Marianas and Eastern districts to extend the mine life beyond 2030; and
- *Yanacocha Sulfides* (South America), developing the first phase of sulfide deposits to produce 45% gold, 45% copper and 10% silver, extending Yanacocha's operations beyond 2040 (in 2Q23, Newmont deferred the investment decision for at least two years to advance Newmont's portfolio optimisation strategy).

Strategy

Newmont's strategy is to create value for all stakeholders (including shareholders) through a centralised operating model focused on:

- delivering superior operational execution by ensuring fatality risks are managed at all times with strong leadership and systems, continually improving operational performance and meeting commitments without fail;
- sustaining a global portfolio of long-life assets by growing margins, reserves and resources from profitable expansions, exploration and value accretive investments; and
- leading the gold sector in profitability and responsibility by consistently generating superior returns, demonstrating its values and leading in ESG performance.

ESG is fundamental to the way Newmont operates. It recognises that mining impacts the environment and alters ecosystems and is committed to protecting the earth, addressing potential environmental threats with solutions, and identifying opportunities to move the industry toward a more sustainable future. Newmont is committed to reducing its greenhouse gas emissions by more than 30% by 2030, ultimately achieving net-zero carbon emissions by 2050, and has a strategy in place (including a strategic alliance with Caterpillar Inc.) to reach these goals. Newmont has been recognised for its industry leadership in ESG performance (including being recognised as the leading gold miner in the Dow Jones Sustainability Index-World and regularly ranking as the most transparent company for sustainability disclosure in the S&P 500).



GRANT SAMUEL



Further discussion of Newmont's strategy is set out in Section 6.6 of the Scheme Booklet.

5.2 Financial Performance

Historical Financial Performance

The historical financial performance⁵² of Newmont for CY20 to CY22 and for 1HY23 is summarised below:

NEWMONT – HISTORICAL FINANCIAL PERFORMANCE (\$ MILLIONS)

	CY20 ACTUAL	CY21 ACTUAL	CY22 ACTUAL	1HY23 ACTUAL
Consolidated gold produced (koz)	5,824	5,884	5,786	2,436
Consolidated gold sold (koz)	5,831	5,897	5,812	2,419
Average realised gold price (per oz)	\$1,775	\$1,788	\$1,792	\$1,936
AISC – gold (per oz)	\$1,045	\$1,062	\$1,211	\$1,424
Consolidated other metals produced (gold equivalent, koz)	1,021	1,252	1,275	544
Consolidated other metals sold (gold equivalent, koz)	1,062	1,258	1,275	516
AISC – other metals (gold equivalent, per oz)	\$858	\$900	\$1,114	\$1,405
Sales	11,497	12,222	11,915	5,362
Adjusted EBITDA⁵³	5,537	5,963	4,550	1,900
Depreciation and amortisation	(2,300)	(2,323)	(2,185)	(947)
Adjusted EBIT⁵⁴	3,237	3,640	2,365	953
Interest expense	(308)	(274)	(227)	(114)
Equity income of affiliates	189	166	107	41
Adjusted income and mining tax expense ⁵⁵	(951)	(1,180)	(717)	(282)
Adjusted net income from continuing operations	2,167	2,352	1,528	598
Adjusted net (income)/loss attributable to non-controlling interests	(27)	19	(60)	(12)
Adjusted net income from continuing operations attributable to Newmont shareholders	2,140	2,371	1,468	586
Adjustments attributable to Newmont shareholders (net of tax)	526	(1,262)	(1,927)	(94)
Net income from discontinued operations	163	57	30	14
Reported net income/(loss) attributable to Newmont shareholders	2,829	1,166	(429)	506
STATISTICS				
Basic EPS (reported)	\$3.52	\$1.46	\$(0.54)	\$0.64
Basic EPS (continuing operations before adjustments)	\$2.66	\$2.97	\$1.85	\$0.74
DPS (declared)	\$1.45	\$2.20	\$2.05	\$0.80
Dividend payout ratio (based on reported EPS)	41%	151%	Nmc	125%
Sales growth	+18%	+6%	-3%	-12% ⁵⁶
Adjusted EBITDA growth	+48%	+8%	-24%	-25% ⁵⁶
Adjusted EBITDA margin	48.2%	48.8%	38.2%	35.4%
Adjusted effective tax rate	32%	35%	34%	34%
Interest cover	10.5x	13.3x	10.4x	8.4x

Source: Newmont and Grant Samuel analysis

⁵² Newmont's historical financial information has been prepared in accordance with the recognition and measurement principles of US GAAP.

⁵³ Adjusted EBITDA includes interest income.

⁵⁴ Adjusted EBIT includes interest income.

⁵⁵ Adjusted income and mining tax expense is before the tax effect of adjustments and valuation and other tax adjustments relating to adjustments (refer below for details).

⁵⁶ Growth is over the prior corresponding period (i.e. 1HY22, the six months ended 30 June 2022).

Annexure 1. Independent Expert's Report

GRANT SAMUEL



SALES AND ADJUSTED EARNINGS

Sales and adjusted earnings (EBITDA and EBIT) represent the operating performance of each of Newmont's 11 wholly owned mineral assets as well as:

- 100% of Merian (in which Newmont owns a 75% interest). The 25% interest owned by Staatsolie is shown as net income/loss attributable to non-controlling interests; and
- Newmont's 38.5% interest in Nevada Gold Mines, which is accounted for using the proportionate consolidation method.

Sales and adjusted earnings do not include the contribution from Newmont's 40% owned Pueblo Viejo joint venture, which is accounted for using the equity accounting method and shown as equity income of affiliates (NPAT contribution). Other joint ventures (NuevaUnión and Norte Abierto) are in the development project pipeline and not yet income producing.

CY20 was the first full year of operation post the acquisition of Goldcorp and the formation of the Nevada Gold Mines joint venture.

Consolidated gold production has been relatively stable over the period from CY20 to CY22. The substantial (in excess of 20%) increase in consolidated production of other metals in CY21 was primarily due to higher throughput from Peñasquito (which was placed in temporary care and maintenance during CY20 as a result of ongoing COVID-19 restrictions). Production volumes were below expectations in 1HY23 due to lower than expected production in 2Q23 (see discussion below).

Newmont achieved growth in sales and adjusted EBITDA in CY20 and CY21 despite the challenges of the COVID-19 pandemic. Sales volumes and prices increased across all metals, generating sales revenue growth (with the higher growth in CY20 due to the Goldcorp and Nevada Gold Mines transactions that were completed during CY19). Adjusted EBITDA margins were maintained at around 48-49% as AISC costs, particularly for gold, increased only marginally and Newmont's Full Potential program (in place since CY14) delivered cost savings and productivity improvements of approximately \$790 million in CY20 and \$800 million in CY21.

Financial performance in CY22 was impacted by challenging market conditions (inflationary pressures and supply chain disruptions caused by the Russian invasion of Ukraine and the continuing impact of the COVID-19 pandemic) resulting in an increase in labour, materials, consumables and fuel and energy prices. Sales revenue was lower for all metals (except copper) as a result of lower sales volumes. Higher costs had a material impact on adjusted EBITDA and the adjusted EBITDA margin, which fell from 48-49% to around 38%, despite Newmont's Full Potential program delivering \$707 million in cost savings and productivity improvements.

1HY23 financial performance was also impacted by lower sales volumes for all metals other than copper. Lower sales volumes included the impact of work stoppage at Peñasquito for the month of June 2023 due to a labour strike, lower production at Akyem to resequence the mine plan and temporarily suspending mining in the main pit to make safety improvements and lower production at Tanami due to significant rainfall and flooding in the Northern Territory in early 2023 which resulted in transportation route closures into the mine and a pause in processing operations for the majority of February 2023 (although mining operations continued and ore was stockpiled). Costs also increased as inflationary pressure continued, resulting in a decline in adjusted EBITDA (and a ~300 basis point decline in the adjusted EBITDA margin to ~35%).

REPORTED NET INCOME

Reported net income has been impacted by adjustments (which are similar to one-off and significant items), particularly in CY21 and CY22. Adjustments for CY20 to CY22 and for 1HY23 are summarised below:



GRANT SAMUEL



NEWMONT – ADJUSTMENTS (\$ MILLIONS)

	CY20 ACTUAL	CY21 ACTUAL	CY22 ACTUAL	1HY23 ACTUAL
Impairment charges	(49)	(25)	(1,320)	(8)
Reclamation and remediation charges	(213)	(1,696)	(713)	2
Pension settlements	(92)	(4)	(137)	-
Change in fair value of assets	252	(135)	(46)	(1)
Gain on asset and investment sales	677	212	35	36
Loss on assets held for sale	-	(571)	-	-
Other	(361)	(39)	(8)	(29)
Total adjustments (pre tax)	214	(2,258)	(2,189)	-
Tax effect of adjustments	(62)	413	344	1
Valuation allowance and other tax adjustments	309	(331)	(82)	(95)
Total adjustments (post tax)	461	(2,176)	(1,927)	(94)
Attributable to non-controlling interests	(65)	(914)	-	-
Attributable to Newmont shareholders	526	(1,262)	(1,927)	(94)

Source: Newmont and Grant Samuel analysis

Total adjustments are shown on a 100% basis (i.e. including adjustments attributable to non-controlling interests) and are attributed to either non-controlling interests or Newmont shareholders.

The major adjustments relate to reclamation and remediation charges in CY21 and CY22, a loss on assets held for sale in CY21 and impairment charges in CY22. Each of these adjustments is discussed further below:

- reclamation and remediation charges primarily represent revisions to remediation plans at former operating assets, portions of current operations that are no longer in production and historical mining operations that have entered the closure phase and have no substantive future economic value⁵⁷;
- the loss on assets held for sale represents the loss recognised due to reclassification of the Conga mill assets as held for sale and being carried at fair value less costs to sell during CY21; and
- impairment charges in CY22 relate primarily to the \$800 million impairment of goodwill⁵⁸ at Porcupine (North America) and Cerro Negro (South America) and the \$515 million impairment of long-lived assets⁵⁹ at Cripple Creek & Victor (North America).

Total adjustments (post tax) are net of the income tax impact of the adjustments as well as valuation allowance and other tax adjustments. Valuation allowance and other tax adjustments is recorded for items such as foreign tax credits, alternative minimum tax credits, capital losses, disallowed foreign losses and the effects of changes in foreign currency exchange rates on deferred tax assets and deferred tax liabilities.

Reported net income has also been impacted by the results from discontinued operations, which relate to contingent consideration associated with the sale of an asset in CY16 and a retained royalty obligation to a third party.

⁵⁷ For example, increased water treatment costs at inactive Yanacocha sites (CY21 and CY22), updated project cost estimates at inactive Porcupine sites (CY22), higher waste disposal costs and project execution delays at the inactive Midnite uranium mine and Dawn mill sites (CY22) as well as higher estimated closure costs at various other non-operating sites due to cost inflation (CY22).

⁵⁸ The Porcupine goodwill impairment was driven by a deterioration in underlying cash flows from higher costs due to inflationary pressures, higher capital costs and an increase to the asset retirement cost. The Cerro Negro goodwill impairment was driven by a 14% country specific discount rate that reflected current macroeconomic risk and uncertainty in Argentina.

⁵⁹ The Cripple Creek & Victor long-lived assets impairment was driven by deterioration in underlying cash flows from lower production (impacted by the decision to place the mill on long term care and maintenance), higher costs due to inflationary pressures and an increase to the asset retirement cost.

Annexure 1. Independent Expert's Report

GRANT SAMUEL



TAX

Newmont's adjusted effective tax rate of ~32-35% is higher than the United States Federal statutory tax rate of 21% due to:

- its operations in foreign jurisdictions that have statutory tax rates significantly different than those in the United States. The effective tax rate is also impacted by tax deductions for depletion allowances (which are highly sensitive to gold and other commodity prices); and
- the inclusion of mining taxes (in Nevada, Mexico, Canada, Peru and Australia) that represent state and provincial taxes levied on mining operations based on a percentage of mining profits.

DIVIDENDS

Since late 2020, Newmont has applied a non-binding structured dividend framework under which shareholders receive a stable base dividend of US\$1.00 per share at the gold reserve price assumption of \$1,400/oz and a variable component based on incremental free cash flow for every \$100/oz increase above the base gold price assumption, calibrated in increments of \$300/oz.

The variable component of the dividend is assessed annually and takes into account the current macroeconomic environment and the current level of reinvestment in the business.

Dividends (excluding special dividends) are paid quarterly and subject to Board approval. Dividends are not franked as dividend imputation is not part of the United States tax system.

Outlook

Newmont has not publicly released earnings forecasts for CY23. However, in conjunction with the release of its CY22 financial results on 23 February 2023, Newmont provided the following guidance for CY23 and CY24⁶⁰ (as well as a five year outlook for certain variables):

- attributable (i.e. based on Newmont's proportionate ownership) gold production of 5.7-6.3Moz in CY23, increasing to 5.9-6.5Moz in CY24 (including production from Newmont's 40% interest in the Pueblo Viejo joint venture);
- gold costs applicable to sales of \$870-970/oz in CY23 and \$850-950/oz in CY24;
- gold AISC of \$1,150-1,250/oz in CY23, improving to \$1,100-1,200/oz in CY24 (assuming higher labour and input costs persist, with the improvement driven by lower cost ounces from reinvestment);
- capital expenditure of \$2.675-3.125 billion in CY23 and \$2.375-2.825 billion in CY24 (excluding contributions to support the Pueblo Viejo expansion) comprising:
 - capital reinvestment on exploration and advanced projects of \$475-525 million (in CY23);
 - sustaining capital expenditure of \$1.0-1.2 billion in each year; and
 - an elevated level of development capital expenditure⁶¹ of \$1.2-1.4 billion in CY23 and \$0.9-1.1 billion in CY24⁶⁰;
- additional guidance for CY23 of:
 - general and administrative costs of \$260-290 million;
 - interest expense of \$200-220 million;
 - depreciation and amortisation of \$2,200-2,400 million; and
 - an adjusted effective tax rate in the range 32-36%.

Gold production is expected to be weighted towards the second half of CY23.

⁶⁰ Updated to reflect the deferral of the decision for the Yanacocha sulfides project, which has reduced expected capital spend by \$300 million in CY24.

⁶¹ Average annual expenditure over a five year period is expected to be ~\$2.5 billion, comprising exploration and advanced projects of ~\$400-500 million, sustaining capital expenditure of ~\$1.0-1.2 billion and development capital expenditure of ~\$0.8-1.0 billion.



GRANT SAMUEL



Newmont also indicated a CY23 dividend payout range of \$1.40-1.80 per share (based on a gold price of \$1,700/oz and subject to quarterly approval by the Newmont Board).

This guidance was confirmed by Newmont in conjunction with the release of its 1HY23 results on 20 July 2023.

5.3 Financial Position

The financial position⁵² of Newmont at 31 December 2022 and at 30 June 2023 is summarised below:

NEWMONT - FINANCIAL POSITION (\$ MILLIONS)

	AT 31 DECEMBER 2022 ACTUAL	AT 30 JUNE 2023 ACTUAL
Trade receivables	366	185
Inventories ⁶² (current)	1,753	1,969
Accounts payable	(633)	(565)
Net working capital	1,486	1,589
Property, plant and mine development (net)	24,073	24,284
Investments	3,312	3,201
Goodwill	1,971	1,971
Inventories ⁶² (non-current)	1,716	1,737
Deferred tax liabilities (net)	(1,636)	(1,629)
Provisions ⁶³	(7,845)	(7,827)
Silver streaming agreement	(828)	(786)
Other assets and liabilities (net) ⁶⁴	(290)	(217)
Total capital employed	21,959	22,323
Cash and cash equivalents	2,877	2,829
Time deposits	829	374
Borrowings	(5,571)	(5,574)
Net borrowings (excluding lease and other financing obligations)	(1,865)	(2,371)
Lease and other financing obligations	(561)	(537)
Net borrowings (including lease and other financing obligations)	(2,426)	(2,908)
Net assets	19,533	19,415
Non-controlling interests	(179)	(190)
Equity attributable to Newmont shareholders	19,354	19,225
STATISTICS		
Shares on issue at period end (million)	793	793
Net assets per share	\$24.41	\$24.24
NTA per share	\$22.15	\$22.00
Net borrowings (excluding lease and other financing obligations)/adjusted EBITDA	0.5x	0.7x
Gearing (including right of use assets and lease and other financing obligations)	11.0%	13.0%

Source: Newmont and Grant Samuel analysis

Similar to Newcrest, the capital intensity of Newmont's operations means that its capital is predominantly deployed in long term fixed assets and liabilities such as:

- property, plant and mine development, which represents more than 100% of total capital employed. The majority of this balance relates to facilities and equipment, production stage mineral interests

⁶² Including stockpiles and ore on leach pads.

⁶³ Provisions includes current and non-current employee-related benefits and current and non-current reclamation and remediation liabilities. The current portion of reclamation and remediation liabilities is included in other current liabilities in Newmont's reported balance sheet.

⁶⁴ Other assets and liabilities (net) includes restricted cash of \$67 million at 31 December 2022 and \$70 million at 30 June 2023.

Annexure 1. Independent Expert's Report

GRANT SAMUEL



and mine development costs (after commencement of production). The balance is primarily construction in progress (primarily related to expansion projects) and capitalised exploration/development costs. Property, plant and mine development also includes right-of-use assets, although these are immaterial in the context of the total balance;

- stockpiles and ore on leach pads that are not expected to be processed within the next 12 months (shown as non-current inventories); and
- reclamation and remediation liabilities, which represents \$7,115 million or ~90% of the provisions at 30 June 2023 (with the balance being employee related benefits). Approximately 55% of the total reclamation liabilities relates to the Yanacocha reclamation obligation in Peru.

Other notable items included in Newmont's financial position at 30 June 2023 are:

- investments, which includes equity accounted affiliates of \$2,948 million (primarily Newmont's 40% interest in Pueblo Viejo as well as 50% interests in the NuevaUnión and Norte Abierto projects) as well as marketable securities of \$253 million⁶⁵ and time deposits of \$374 million;
- goodwill of \$1,971 million which primarily relates to the acquisition of Goldcorp's North American assets (goodwill relating to the acquisition of Goldcorp's South American assets was written down to nil during CY22) and the formation of the Nevada Gold Mines joint venture;
- the silver streaming liability agreement related to silver production from Peñasquito which was assumed by Newmont as part of the Goldcorp transaction. Under the agreement, Newmont is obliged to sell 25% of silver production from Peñasquito to Wheaton Precious Metals Corporation at the lesser of market price or a fixed contract price, subject to an annual inflation adjustment of up to 1.65%. The agreement liability was initially recognised at fair value as a finite-lived intangible liability and is amortised into sales each period;
- Newmont has been an unhedged gold producer since July 2007 when it eliminated its entire 1.85Moz gold hedge position. Newmont does manage certain risks associated with commodity input costs (e.g. diesel prices), interest rates and foreign currencies (e.g. capital expenditure denominated in currencies other than United States dollars⁶⁶) using the derivatives market; and
- non-controlling interests which relate to Merian. As the 75% owner of Merian, Newmont consolidates Merian in its financial statements and shows Staatsolie's 25% interest in Merian's net assets as a non-controlling interest adjustment to net assets to determine net assets attributable to Newmont shareholders.

Newmont's borrowings consist principally of senior notes issuance:

NEWMONT – NET BORROWINGS AT 30 JUNE 2023 (\$ MILLIONS)

FACILITY	FACILITY SIZE	CARRYING VALUE	TERM/MATURITY
Senior notes	-	(5,624)	October 2029 - June 2044
Corporate revolving credit facility	3,000	-	March 2026
Capitalised borrowing costs		50	
Total interest bearing liabilities		(5,574)	
Cash and cash equivalents (including time deposits)		3,203	
Lease and other financing obligations		(537)	
Net borrowings (including lease and other financing obligations)		(2,908)	

Source: Newmont

⁶⁵ At 31 December 2022, investments also included a 28.5% interest in Maverix Metals Inc. ("Maverix"). Maverix was acquired by Triple Flag Precious Metals Corporation in January 2023 and Newmont's 7.5% ownership interest in the combined group was subsequently accounted for as a marketable security prior to its sale on market on 29 March 2023.

⁶⁶ For example, in October 2022, Newmont entered into A\$574 million of A\$ denominated fixed forward contracts to mitigate variability in the US\$ functional cash flows related to the A\$ denominated capital expenditure expected to be incurred in CY23 and CY24 during the construction and development phase of the Tanami Expansion 2 project.

GRANT SAMUEL



Senior notes comprise seven separate public offerings of notes ranging in size from \$450 million to \$1,100 million. Interest rates on the senior notes range from 2.25% to 6.25%, with a weighted average cost of debt of 4.1%. Senior note maturities are spread over more than 20 years, with the next debt maturity not until October 2029 (i.e. more than six years away). Newmont's senior notes issuance includes the gold sector's first sustainability linked bond, a public offering of \$1.0 billion of principal maturing in July 2032 at an interest rate of 2.6% (with the coupon linked to Newmont's performance against key ESG commitments regarding 2030 climate targets and the representation of women in senior roles target, with a maximum adjustment of +0.6%). All of the senior notes are unsecured and rank equally with each other.

The \$3.0 billion sustainability linked corporate revolving credit facility expires in March 2026 and has an interest rate margin that is subject to adjustment based on Newmont's ESG scores (maximum adjustment +/- 0.05%). The facility was undrawn at 30 June 2023.

The senior notes and the corporate revolving credit facility are subject to various covenants (including limiting the sale of all or substantially all of Newmont's assets, certain change of control provisions and a negative pledge on certain assets) and default provisions (including payment defaults, limitation on liens, leases, sales and leaseback agreements and merger restrictions). At 30 June 2023, Newmont was in compliance with all debt covenants and provisions related to potential defaults.

Newmont had total liquidity (cash balance plus undrawn corporate revolving credit facility) at 30 June 2023 of \$6.2 billion.

Newmont has investment grade credit ratings of BBB+ from S&P and Baa1 from Moody's.

5.4 Cash Flow

Newmont's cash flow⁵² for CY20 to CY22 and for 1HY23 is summarised below:

NEWMONT - CASH FLOW (\$ MILLIONS)

	CY20 ACTUAL	CY21 ACTUAL	CY22 ACTUAL	1HY23 ACTUAL
Reported net income/(loss) attributable to Newmont shareholders	2,829	1,166	(429)	506
Net income/(loss) attributable to non-controlling interests	(38)	(933)	60	12
Total net income/(loss)	2,791	233	(369)	518
Depreciation and amortisation	2,300	2,323	2,185	947
Non-cash adjustments	(496)	2,251	2,223	141
Net change in operating assets and liabilities	295	(541)	(841)	(469)
Net cash provided by/(used in) operating activities of discontinued operations	(8)	13	22	7
Net cash provided by operating activities	4,882	4,279	3,220	1,144
Additions to property, plant and mine equipment	(1,302)	(1,653)	(2,131)	(1,142)
Other investing cash flows	1,393 ⁶⁷	(215)	(852)	642
Dividends and distributions paid	(1,031)	(1,957)	(1,937)	(702)
Payments on lease and other financing obligations	(66)	(73)	(66)	(32)
Repurchases of common stock	(521)	(525)	-	-
Other	113	(13)	(264)	50
Net cash generated/(used)	3,468	(157)	(2,030)	(40)

⁶⁷ The relatively high investing cash inflow in CY20 included \$1.2 billion from asset sales (i.e. the sale of the Red Lake Complex in Canada, a 50% interest in Kalgoorlie Consolidated Gold Mines in Australia, investment holdings in Continental Gold and a portfolio of 11 royalties). Since completion of the Goldcorp acquisition in 2019, Newmont has realised in excess of \$2 billion in cash proceeds from the sale of non-core assets as part of its strategy to maximise value for shareholders and other stakeholders.

Annexure 1. Independent Expert's Report

GRANT SAMUEL



NEWMONT – CASH FLOW (\$ MILLIONS) (CONT)

	CY20 ACTUAL	CY21 ACTUAL	CY22 ACTUAL	1HY23 ACTUAL
Net cash/(borrowings) ⁶⁸ – opening	(3,895)	(491)	(660)	(2,694)
Effect of movements in exchange rates and restricted cash ⁶⁹	(64)	(12)	(4)	(11)
Net cash/(borrowings) ⁶⁸ – closing	(491)	(660)	(2,694)	(2,745)
STATISTICS				
Free cash flow (consolidated)	3,588	2,613	1,067	(5)
Cash flow conversion	100%	101%	99%	na
Capital expenditure as a % of adjusted EBITDA	24%	28%	47%	60%

Source: Newmont and Grant Samuel analysis

Newmont has a track record of strong operating cash flow generation with cash flow conversion consistently at or around 100%. The decline in cash generated from operations in CY22 was in line with the fall in adjusted EBITDA and adjusted net income in that year.

The consistent decline in free cash flow is due to an increase in Newmont's capital expenditure requirements (which have increased from 24% of adjusted EBITDA in CY20 to 60% of adjusted EBITDA in 1HY23) and reflects:

- higher sustaining capital expenditure required in CY21 at sites that were placed into care and maintenance or experienced reduced operations in response to the COVID-19 pandemic in CY20 (i.e. capital expenditure was lower in CY20 than it would have been in the absence of the COVID-19 pandemic); and
- a shift to development capital expenditure in CY21 and CY22 (with development capital expenditure increasing from 30% of total capital expenditure in CY20 to 42% in CY21, 52% in CY22 and 42% in 1HY23). The substantial increase in development capital expenditure in CY22 reflected the start of a period a reinvestment by Newmont in its development pipeline to strengthen its global portfolio.

The increase in capital expenditure, combined with lower operating cash flows in CY22 and 1HY23 have resulted in dividends and distributions paid exceeding free cash flow in CY22 and 1HY23 and, consequently, an increase in net borrowings. Net borrowings (excluding time deposits and leases and other financial obligations) at 30 June 2023 was \$2.7 billion, close to Newmont's highest level of net borrowings since the start of CY20, although net borrowings still represents a relatively modest gearing ratio (based on the book value of net assets) of 13% and a net borrowings to adjusted EBITDA ratio of 0.7x (well below Newmont's target of less than 1.0x). These ratios are consistent with Newmont's disciplined approach to capital allocation, where its priorities are to:

- maintain an investment grade balance sheet with financial strength and flexibility;
- reinvest in its business through exploration and organic growth to ensure current and future resource and reserve positions can continue to support its portfolio of operations and projects; and
- return excess cash to shareholders through its structured dividend framework.

Excess cash in CY20 and CY21 was returned to shareholders in the form of higher dividends and share repurchase plans. Newmont returned \$1.3 billion to shareholders in CY20 and \$2.3 billion in CY21⁷⁰.

⁶⁸ For the purposes of the cash flow, net borrowings excludes time deposits (which are included in investing cash flows) and lease and other financing obligations.

⁶⁹ Includes effect of exchange rates on cash, effect of exchange rates on debt and movement in restricted cash.

⁷⁰ These amounts exclude distributions to non-controlling shareholders which are included in dividends and distributions paid in the cash flow table above.

GRANT SAMUEL



5.5 Capital Structure and Ownership

Capital Structure

Newmont has the following securities on issue:

- 794,795,993 shares of common stock (excluding 6,011,122 treasury shares);
- 1,915,296 restricted stock units;
- 225,725 director stock units; and
- 1,253,707 performance stock units.

Newmont has stock incentive plans for directors, executives and eligible employees. Stock incentive awards include:

- restricted stock units, which generally vest on a straight-line basis over a three year period, subject to the holder meeting a personal performance factor. Restricted stock units are subject to forfeiture risk and other restrictions. Prior to vesting, holders of restricted stock units do not have the right to vote the underlying shares, but holders accrue dividend equivalents which are paid at the time the restricted stock units vest (but not if the restricted stock units are forfeited). On vesting, holders are entitled to receive one share of common stock for each restricted stock unit;
- performance stock units, which vest after a three year performance period based on Newmont's total shareholder return compared to the return of a peer group, 20% of which is attributable to specific performance measures (10% relates to meeting certain climate targets and 10% relates to achieving metrics regarding women in leadership roles); and
- director stock units, whereby \$180,000 of common stock is issued to each non-executive director every year. Director stock units represent the right to receive shares of common stock upon retirement from the board of directors and are immediately fully vested and non-forfeitable. The holders of director stock units do not have the right to vote the underlying shares but the director stock units accrue dividends which are paid when the common shares are issued.

Newmont issues new shares of common stock to satisfy vesting under its stock incentive awards and the exercise of options. At 30 June 2023, there were 21,442,378 shares authorised for future stock incentive plan awards.

Newmont does not have a dividend reinvestment plan.

Ownership

At 16 February 2023 there were approximately 7,100 registered shareholders in Newmont. The top 20 shareholders accounted for just over 50% of the shares on issue and are principally United States based investment advisors (i.e. fund managers).

The following entities beneficially own 5% or more of Newmont's shares:

NEWMONT – SUBSTANTIAL SHAREHOLDERS

SHAREHOLDER	DATE OF NOTICE	NUMBER OF SHARES	PERCENTAGE ⁷¹
Blackrock, Inc.	31 December 2022	92,123,660	11.60%
The Vanguard Group, Inc.	31 December 2022	69,210,466	8.72%
State Street Corporation	31 December 2022	40,484,102	5.10%

Source: Scheme Booklet

⁷¹ Based on shares on issue at 31 December 2022.

GRANT SAMUEL



5.6 Share Price Performance

Newmont shares are listed on both the NYSE and the TSX, although the NYSE is its primary listing and is where the vast majority of trading in its shares occurs. Accordingly, this section covers only the share price performance of Newmont shares on the NYSE.

The following graph illustrates the movement in the Newmont share price and trading volumes since 1 January 2019:

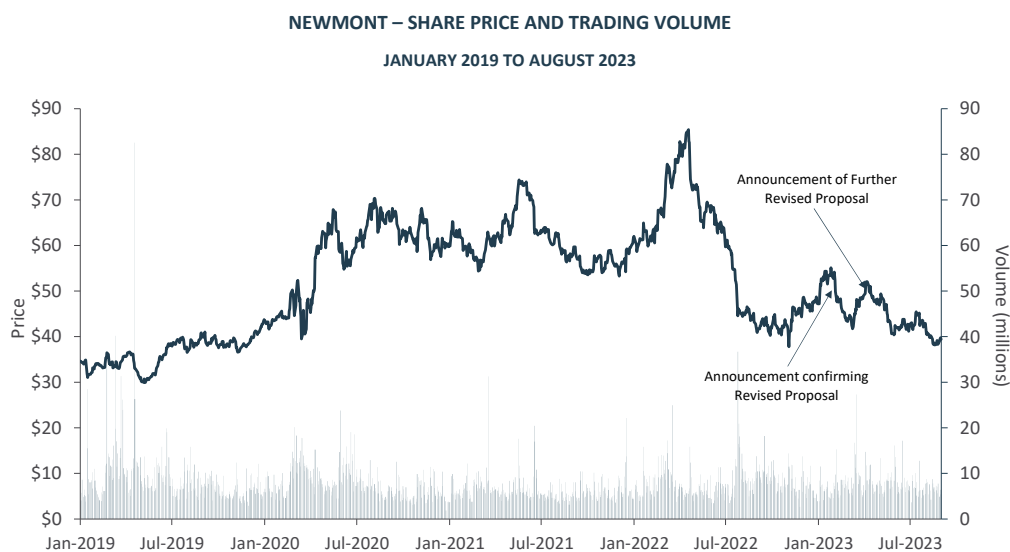

Source: Bloomberg

There had been a general upward trend in the Newmont share price from January 2019 until mid-April 2022, but this was followed by a steep decline (of almost 50%) through to mid-July 2022. As is the case with Newcrest, movements in Newmont's share price largely reflect its unhedged exposure to the gold price, as illustrated in the chart below:

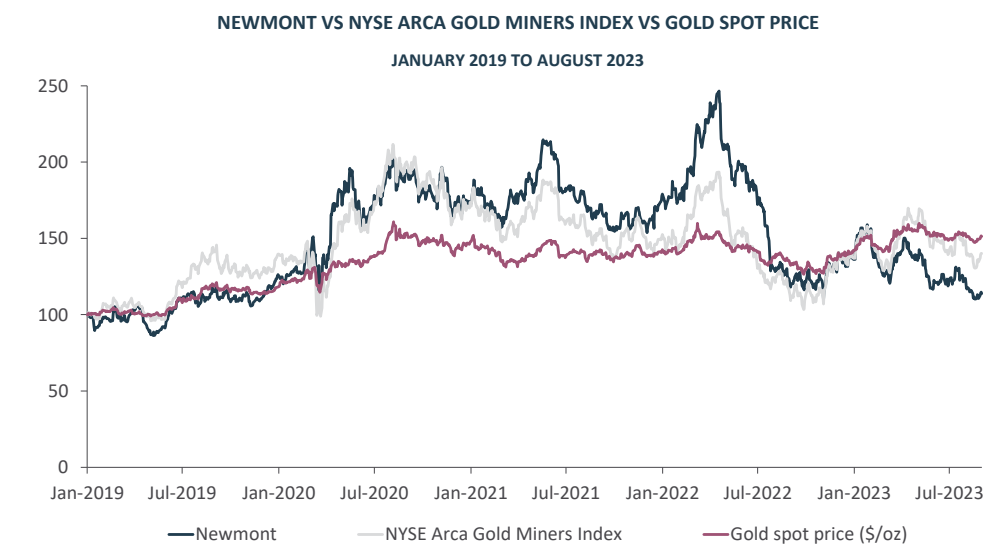

Source: IRESS and Bloomberg

GRANT SAMUEL



Deviations from movements in the gold price over this period (up until announcement of the Revised Proposal) have reflected the:

- initial reaction to the COVID-19 pandemic in mid-to-late March 2020, including government restrictions forcing the curtailment of mining operations at Yanacocha, Peñasquito and three other North American and South American mines. However, the initial negative share price reaction was more than offset by:
 - the designation of mining as an essential service in every jurisdiction where Newmont operates (and Newmont subsequently ramping up operations at all but one mine by May 2020); and
 - Newmont increasing its quarterly dividend by 79% to \$0.25 per share in April 2020 and providing a revised CY20 outlook and confirming its long term guidance in May 2020.

The uplift in Newmont's share price over this period was similar to that of other members of the NYSE Arca Gold Miners Index, indicating that Newmont's peers experienced a similar initial negative reaction which was more than offset by a subsequent uplift as mining was designated as an essential service;

- announcement of record CY20 results in February 2021 and a 1Q21 dividend of \$0.55 per share in April 2021 (consistent with the 4Q20 dividend and a 120% increase on the 1Q20 dividend of \$0.25 per share); and
- announcement of strong CY21 results and an uplift in reserves in February 2022 and S&P upgrading Newmont's issuer credit rating from BBB to BBB+ with a stable outlook in March 2022. The upgrade of Newmont's issuer credit ratio was supported by its balance sheet strength and disciplined capital allocation priorities in addition to expectations of higher future production and improving costs and followed Newmont's issuance of the mining industry's first sustainability-linked bond in December 2021. The Newmont share price also outperformed the NYSE Arca Gold Miners Index over this period (i.e. the Newmont share price increased more than the share prices of its peers).

However, the impact of these positive announcements was more than offset by the announcement of weaker results for 1Q22 (relative to 1Q21 and 4Q21) in April 2022 and 2Q22 (relative to 2Q21 and 1Q22) in July 2022, primarily due to higher (inflationary and supply chain) costs. The relative decline in Newmont's share price from April to July 2022 was greater than the decline in the NYSE Arca Gold Miners Index over the same period, bringing the Newmont share price back into line with the gold price and the NYSE Arca Gold Miners Index.

The Newmont share price closed at \$49.85 on 3 February 2023, the last trading day prior to Newmont confirming the Revised Proposal. Following the announcement, Newmont shares traded downwards (more so than the gold price), reaching a low of \$41.68 on 9 March 2023 before recovering to as high as \$52.76 on 5 April 2023 (when the gold price was slightly over \$2,000/oz). Since April 2023, the Newmont share price has again fallen (including following announcement of the Further Revised Proposal on 10 April 2023 and the Newmont Transaction on 14 May 2023, both New York time), despite the gold price being relatively stable (albeit below \$2,000/oz) over this period. The share price closed at \$39.42 on 31 August 2023 and at \$39.32 on 1 September 2023.

Further discussion of Newmont's share price performance is set out in Section 6.3 of this report.

Annexure 1. Independent Expert's Report

GRANT SAMUEL



6 Assessment of the Value of the Consideration

6.1 Summary

Under the Newmont Transaction, Newcrest shareholders (other than ineligible foreign shareholders¹) will receive, for each Newcrest share held:

- the Scheme consideration of 0.400 Newmont securities²; and
- \$1.10 in cash, expected to take the form of a franked³ special dividend paid by Newcrest on or around implementation of the Scheme.

Grant Samuel has attributed a value to the Scheme consideration of \$16.00-17.60 per Newcrest share based on a value range for Newmont shares of \$40.00-44.00. Including the special dividend to be paid by Newcrest, the value of the consideration to Newcrest shareholders is \$17.10-18.70 per share as follows:

ASSESSMENT OF THE VALUE OF THE CONSIDERATION UNDER THE NEWMONT TRANSACTION

COMPONENT	VALUE
Assessed value per Newmont share	\$40.00-44.00
Exchange ratio	0.400
Assessed value of Scheme consideration	\$16.00-17.60
Special dividend	\$1.10
Assessment of value of consideration per Newcrest share	\$17.10-18.70

The value of the Scheme consideration will vary with movements in the Newmont share price. Accordingly, until the Newmont Transaction is implemented and the shares are issued, Newcrest shareholders are exposed to events or other factors that impact the Newmont share price. The actual realisable value of the consideration could therefore ultimately exceed, or be less than, \$17.10-18.70 per Newcrest share. Depending on the circumstances, significant (and sustained) movements in the Newmont share price could change the evaluation of the Newmont Transaction.

6.2 Approach

The Newmont Transaction involves a change of control of Newcrest. For the purposes of takeover analysis, the relevant test for Newcrest shareholders is the expected market value of the Newmont securities plus the special dividend received as consideration under the Newmont Transaction. This involves an estimation of the trading price for Newmont after the Newmont Transaction is implemented (rather than a pre bid price). In other words, the relevant metric is the price at which shares in the Merged Group will trade immediately following implementation of the Newmont Transaction. The theoretical market value of shares in a standalone Newmont is not relevant to an assessment of the value of the consideration.

It is normal practice to use the post announcement market price as the starting point for estimating the value of an offer with a scrip component. An alternative method is to estimate the underlying value of the combined entity and then to apply a discount to reflect a portfolio interest. However:

- access to the detailed financial and operational information (such as earnings and operational forecasts or asset plans) of both parties is required to undertake such a fundamental analysis of the value of the consideration; and
- while the portfolio discount could generally be expected to fall somewhere in the approximate range 15-25%, the precise amount of the discount to apply is uncertain.

Furthermore, the consensus view of a well traded market is likely to be a more reliable estimate than that of a single external observer. Market prices (particularly for entities such as Newmont that enjoy high levels of market liquidity and are followed by a number of market analysts) usually incorporate the influence of all publicly available information on an entity's prospects, future earnings and risks.



GRANT SAMUEL



Grant Samuel has had regard to the market price of Newmont following the announcement of the Revised Proposal and addressed the following questions:

- is there any reason why the market price is not a true reflection of the fair market value of Newmont shares? For example, there could be:
 - important information about the entity and its business/assets which would affect the share price but is not in the public domain;
 - mispricing by the market; and/or
 - abnormal trading activity in Newmont shares; and
- will the proposed transaction, if implemented, have a material impact on Newmont's financial metrics, growth prospects, risk profile or other factors that would be likely to result in a change in the share price?

In considering these questions, Grant Samuel has:

- analysed the recent trading in Newmont shares;
- compared key value metrics for Newmont to those of its peers;
- reviewed broker analyst research on Newmont; and
- analysed the impact of the Newmont Transaction on Newmont's key financial metrics.

6.3 Analysis of Sharemarket Trading in Newmont Shares

Share Price Performance

Newmont's share price performance since January 2019 is discussed in Section 5.6 of this report. Share price performance and trading volumes since 1 September 2022 are summarised in the chart below:

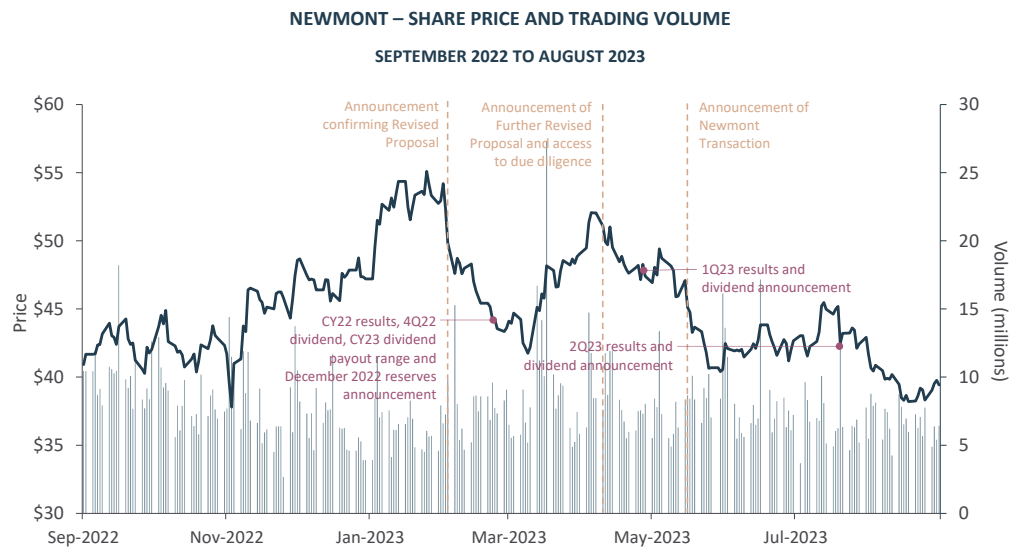

Source: Bloomberg

Newmont's share price in the period before announcement of the Revised Proposal is of limited relevance in assessing the likely trading price of shares in the Merged Group. However, it is useful to consider it briefly to provide background context to the assessment.

Annexure 1. Independent Expert's Report

GRANT SAMUEL



Over the period from 1 September 2022 to 3 February 2023 (being the last trading day prior to announcement of the Revised Proposal), Newmont shares traded in the range \$37.45-55.41 and at a VWAP of \$45.36.

There was a strong increase in the Newmont share price over this period. While there was a dip following the release of weaker results for 3Q22 (relative to 2Q22 and 3Q21) as inflation and supply chain issues continued to increase costs, the share price was subsequently buoyed by the October 2022 announcement of a 3Q22 dividend of \$0.55 per share, in line with the past eight quarters (despite Newmont's weaker performance). It is unclear what caused the significant (~10%) increase in Newmont's share price in early January 2023, immediately following the Christmas/New Year break during a period when no market announcements were made by Newmont. Trading volumes were also higher during this period.

Trading in Newmont shares between 4 January 2023 and 3 February 2023 (the month prior to announcement of the Revised Proposal) was in a narrower range of \$49.57-55.41 and at a VWAP of \$52.61. The closing price on 3 February 2023 was \$49.85.

Following announcement of the Revised Proposal, Newmont shares traded in a lower, but relatively wide range of \$37.84-52.76, at a VWAP of \$44.57, and closed at \$39.32 on 1 September 2023.

Newmont's share price fell following announcement of the Revised Proposal but was already on a downward trend prior to the announcement, with the closing price falling by 8% from \$54.19 on 1 February 2023 to \$49.85 on 3 February 2023, more than the decline in the NYSE Arca Gold Miners Index of 5.8% and almost double the fall in the gold price over the same period.

Other than announcements related to the Newmont Transaction (i.e. the Further Revised Proposal and access to confirmatory due diligence on 10 April 2023 and entry into the scheme implementation deed with Newcrest on 14 May 2023, both New York time), the key announcements made by Newmont over this period have related to its financial results and dividend payments:

- on 23 February 2023, Newmont announced that it had achieved its CY22 guidance, provided a stable CY23 outlook and an improving longer term outlook and declared a \$0.40 per share 4Q23 dividend as well as increased December 2022 mineral reserves of 96Moz of gold and 68 million gold equivalent ounces of other metals.

Newmont also announced a CY23 dividend payout range of \$1.40-1.80 per share, based on a gold price of \$1,700/oz and incremental free cash flow of approximately \$800 million, which took into account the cash flow impact of industry-wide inflationary pressures and a period of reinvestment for Newmont;

- on 27 April 2023, Newmont announced that it had delivered its expected 1Q23 results (albeit these results were weaker than those achieved in 4Q22 and 1Q22) and was on track to achieve CY23 full year guidance. It also declared a \$0.40 1Q23 dividend, consistent with the CY23 dividend payout range announced in February 2023; and
- on 20 July 2023, Newmont announced its 2Q23 results which included production that was below expectations (and less than 1Q23 and 2Q22) and costs that were above expectations (and higher than 1Q23 and 2Q22). Despite these weaker than expected results, Newmont announced that it remained on track to achieve CY23 full year guidance. It also declared a \$0.40 2Q23 dividend.

It is possible that the downward pressure on Newmont's share price reflects a combination of:

- the continued increase in direct operating costs in 4Q22, 1Q23 and 2Q23 (and the consequent negative impact on adjusted earnings and free cash flow) as a result of industry wide inflationary pressures, driven by higher labour costs and an increase in commodity input costs (e.g. fuel) as well as higher sustaining capital expenditure (albeit the rate of inflation on commodities, material and supplies eased in 1Q23 and 2Q23). The 1Q23 and 2Q23 gold AISCs of \$1,376/oz and \$1,472/oz



GRANT SAMUEL



respectively were in excess of Newmont's CY23 guidance of \$1,150-1,250/oz mostly due to lower production volumes rather than ongoing cost increases;

- the relatively conservative CY23 dividend payout range of \$1.40-1.80 per share announced in conjunction with the release of Newmont's CY22 financial results, which is a lower annual dividend per share than in CY22 (\$2.05 per share) and CY21 (\$2.20 per share), despite an increase in the gold price over these periods; and
- the increased offer for Newcrest (from 0.38 Newmont shares to 0.40 Newmont shares plus a special dividend of up to \$1.10 for each Newcrest share) announced on 10 April 2023 (New York time), which diluted Newmont shareholders' interest in the Merged Group.

There have also been suggestions that hedge fund (short) trading may have depressed the Newmont share price following announcement of the Newmont Transaction and, more recently, the release of its 2Q23 results.

The important question is whether the recent performance and current price (at the date of this report) reflect the rational view of a well informed market or, alternatively, whether Newmont is out of line with its peers or the market.

In addressing this issue Grant Samuel has considered the factors set out below.

Newmont Share Price Compared to its Peers and the Market

The following graph illustrates the performance of Newmont shares since 1 September 2022 relative to the NYSE Arca Gold Miners Index and the gold spot price:

NEWMONT VS NYSE ARCA GOLD MINERS INDEX VS GOLD SPOT PRICE
SEPTEMBER 2022 TO AUGUST 2023



Source: Bloomberg

This graph shows that the Newmont share price has:

- generally tracked the gold price (other than for brief periods in early November 2022 and early January 2023) up until the announcement confirming the Revised Proposal on 5 February 2023 (Sunday, New York time). Since that time, Newmont shares have generally underperformed relative to the gold price (primarily in May 2023), in part due to increasing costs. While the Newmont share price recovered to trade in line with the gold price by mid-March 2023, the underperformance reappeared following announcement of the Further Revised Proposal on 10 April 2023 (New York

Annexure 1. Independent Expert's Report

GRANT SAMUEL



time) and the extent of the underperformance increased subsequent to announcement of the Newmont Transaction on 14 May 2023 (Sunday, New York time); and

- similarly tracked the NYSE Arca Gold Miners Index (including during January 2023) up until just prior to the announcement confirming the Revised Proposal. The NYSE Arca Gold Miners Index is focused on the largest gold producers globally. It is a rules-based index weighted by modified market capitalisation⁷² and is not adjusted for free float. The top five stocks represent around 40% of the index⁷³, even though it has 46 constituents. The increase in the NYSE Arca Gold Producers Index (relative to the gold price) in early January 2023 in part reflects Newmont's representation in the index (it is the second largest stock in the index with around an 8% weighting).

The disparity between the Newmont share price, the gold spot price and the NYSE Arca Gold Producers Index since the announcement confirming the Revised Proposal is illustrated in the chart below:

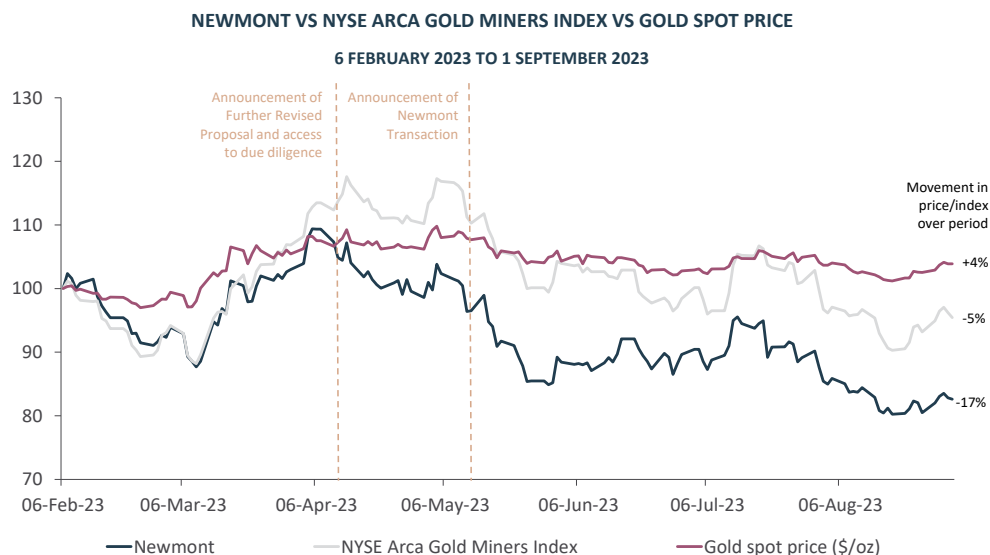

Source: Bloomberg

This chart clearly shows the underperformance of Newmont shares relative to the gold price following announcement of the Further Revised Proposal:

- from announcement of the Further Revised Proposal until announcement of the Newmont Transaction, the Newmont share price declined despite the gold price remaining relatively stable. By 12 May 2023 (the last trading day prior to announcement of the Newmont Transaction), Newmont shares had declined by 8% relative to the gold price; and
- subsequent to announcement of the Newmont Transaction the differential has widened. Even after taking into account the slight decline in the gold price over this period and some recent improvement in the Newmont share price, Newmont shares had declined by 18% relative to the gold price by 1 September 2023 (from prices on announcement of the Further Revised Proposal).

⁷² The index is weighted based on the market capitalisation of each of the component stocks, modified to conform to asset diversification requirements (i.e. the weight of any single component stock may not account for more than 20% of the index, the final aggregate weight of large stocks (with a starting index weight greater or equal to 5%) will represent 45% of the final weight index and the final aggregate weight of small stocks (with a starting index weight of less than 5%) will represent 55% of the final weight index).

⁷³ The top five stocks in the NYSE Arca Gold Producers Index are Zijin Mining Group Co., Ltd (based in China), Newmont, Barrick Gold, Franco-Nevada and Agnico Eagle Mines.



GRANT SAMUEL



While performance was more aligned with the NYSE Arca Gold Producers Index, there was also divergence from this index subsequent to announcement of the Further Revised Proposal on 10 April 2023 (New York time) (particularly during May 2023):

NEWMONT VS NYSE ARCA GOLD MINERS INDEX VS GOLD SPOT PRICE

11 APRIL 2023 TO 1 SEPTEMBER 2023

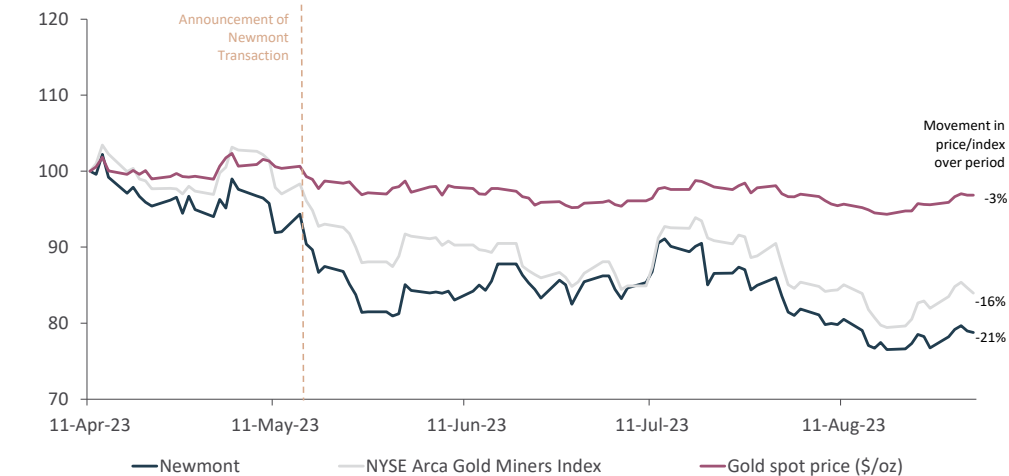

However, this divergence may in part be explained by the 16 March 2023 announcement by Gold Fields and AngloGold Ashanti to establish a Ghana joint venture to create Africa's largest gold mine (see the charts below which clearly show the outperformance of Gold Fields and AngloGold Ashanti from mid-March and through April 2023). This divergence had largely disappeared by the end of June 2023 although Newmont again underperformed relative to the NYSE Arca Gold Miners Index following the announcement of its 2Q23 results on 20 July 2023.

The following graph illustrates the performance of Newmont shares since 1 September 2022 relative to its peers (as well as the NYSE Arca Gold Miners Index):

NEWMONT VS SELECTED LISTED GOLD PRODUCERS

SEPTEMBER 2022 TO AUGUST 2023

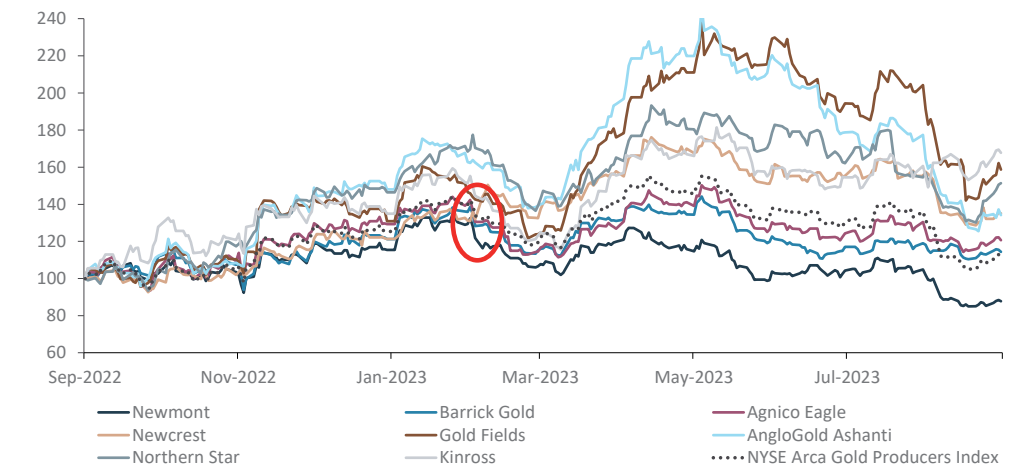

Annexure 1. Independent Expert's Report

GRANT SAMUEL



This chart shows the positive correlation between the trading prices of Newmont shares and the shares of its peers (other than the outperformance of Gold Fields and AngloGold Ashanti referred to above), at least until March 2023. The chart also clearly shows the relative decline in Newmont's share price (and the corresponding increase in Newcrest's share price) at the time of announcement of the Revised Proposal on 5 February 2023 (circled in red).

The positive correlation between trading in Newmont shares and the shares of its peers (other than Gold Fields and AngloGold Ashanti) has continued since 6 February 2023, as illustrated in the chart below:

NEWMONT VS SELECTED LISTED GOLD PRODUCERS

6 FEBRUARY 2023 TO 1 SEPTEMBER 2023

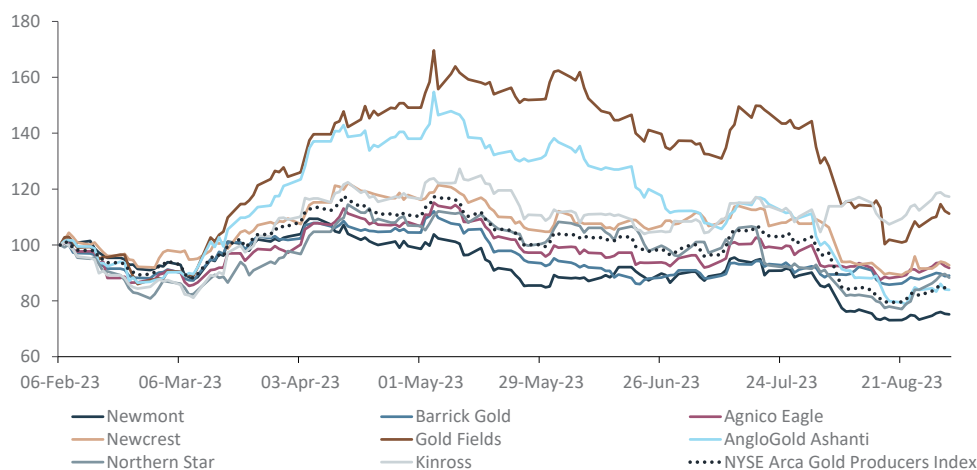

Source: IRESS, Bloomberg and Grant Samuel analysis

Since 11 April 2023, the share prices of all gold sector peers have moved in a very similar fashion:

NEWMONT VS SELECTED LISTED GOLD PRODUCERS

11 APRIL 2023 TO 1 SEPTEMBER 2023

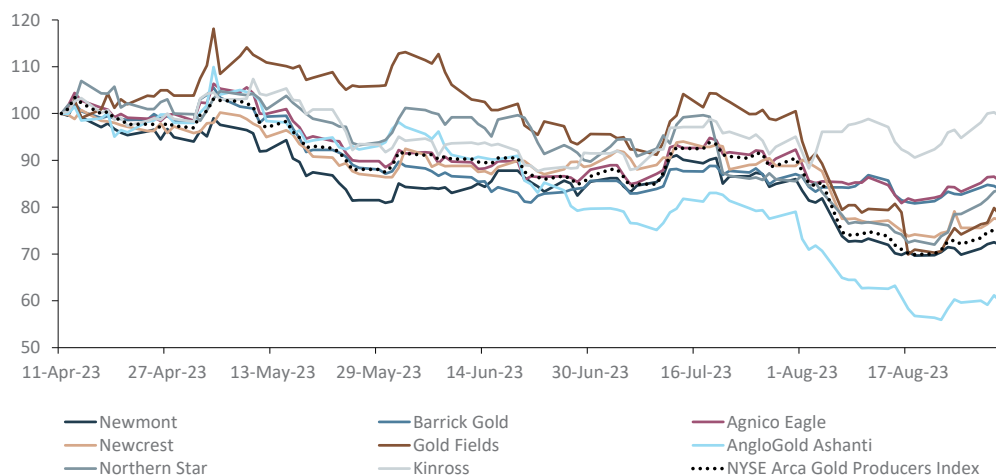

Source: Bloomberg and Grant Samuel analysis

GRANT SAMUEL



While Newmont's share price has trended in the same direction as its peers, its shares have been weaker relative to all of its peers since announcement of the Further Revised Proposal on 10 April 2023 (New York time) (albeit some of its peers (i.e. Northern Star, Gold Fields and AngloGold Ashanti) traded at similarly weak levels in July 2023). Trading in Newmont shares and Newcrest shares has been relatively consistent since 11 April 2023, particularly after taking into account the weakening of the A\$ against the US\$ over this period.

This analysis indicates there is nothing to suggest that trading in Newmont shares has been materially out of line with its peers but it has generally been the weakest performer. This relative underperformance, particularly since 6 February 2023, is likely to reflect its relatively conservative CY23 dividend payout range of \$1.40-1.80 per share announced on 23 February 2023, the increased offer for Newcrest announced on 10 April 2023 and the weaker than expected 2Q23 results announced on 20 July 2023 (all New York time).

The market price of Newcrest shares has closely tracked the Newmont share price since 6 February 2023, suggesting a market expectation that the Newmont Transaction will be implemented.

On this basis, it is reasonable to conclude that the recent Newmont trading price reflects an expectation of the share price for the Merged Group and that it incorporates:

- information provided to the market through the release of Newmont's 1Q23 results on 27 April 2023 and its 2Q23 results on 20 July 2023; and
- the impact of the terms of the Newmont Transaction on Newmont shares, including:
 - the proportion of Newmont securities that will be held by Newcrest shareholders (approximately 31%) and the additional debt that Newmont will take on through its acquisition of Newcrest (Newcrest had net borrowings including lease liabilities of \$1,459 million at 30 June 2023);
 - the extent of the takeover premium to be paid to Newcrest shareholders (and the value transfer from Newmont shareholders to Newcrest shareholders implicit in that premium); and
 - the quantum of the synergies expected to be realised (at least to the extent that the market believes these synergies will be achieved).

Newmont Market Ratings Compared to its Peers

Newmont's and the Merged Group's market ratings (in terms of forecast EBITDA multiples, forecast dividend yields and gearing) relative to its gold producer peers is illustrated below:

Annexure 1. Independent Expert's Report

GRANT SAMUEL



SELECTED LISTED GOLD PRODUCERS

FORECAST EBITDA MULTIPLES^{74,75}

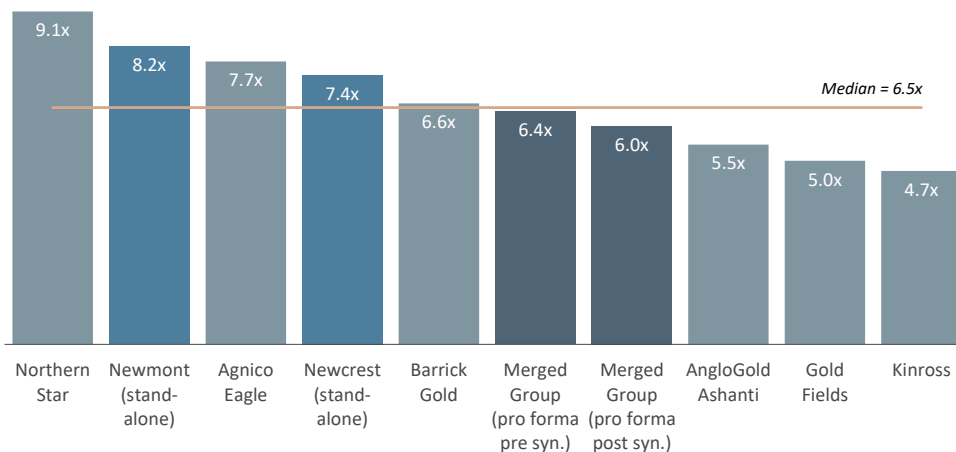

Source: Grant Samuel analysis (see Appendix 5)

SELECTED LISTED GOLD PRODUCERS

FORECAST DIVIDEND YIELDS^{74,75}

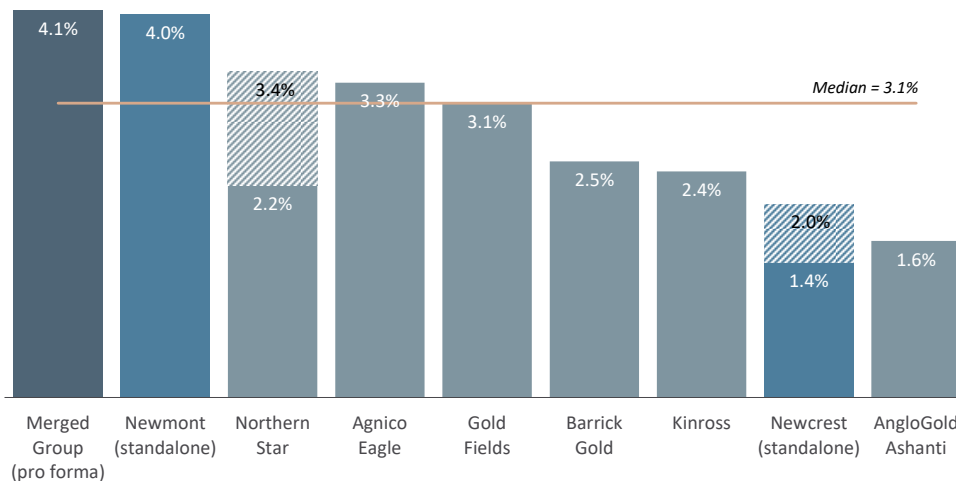

Source: Grant Samuel analysis (see Appendix 5)

Note: Hatched areas for Newcrest (standalone) and Northern Star show the dividend yield grossed up for franking credits.

⁷⁴ Based on sharemarket prices at 31 August 2023 except for Newcrest (standalone) and Newmont (standalone) which are at 3 February 2023 (the last trading day prior to announcement of the Revised Proposal). The Newcrest (standalone) and Newmont (standalone) multiples and ratios are based on information available to the market at that time (i.e. 30 September 2022 balance sheet and CY22 forecast EBITDA for Newmont and 30 June 2022 balance sheet and FY23 forecast EBITDA for Newcrest).

⁷⁵ All of the listed entities have a 31 December year end except Northern Star and Newcrest. Forecast EBITDA multiples and dividend yields for all of the listed entities other than Northern Star, Newmont (standalone) and Newcrest (standalone) are for CY23. The forecast EBITDA multiple and dividend yield for Northern Star is for FY24, for Newmont (standalone) is for CY22 and for Newcrest (standalone) is for FY22.

GRANT SAMUEL

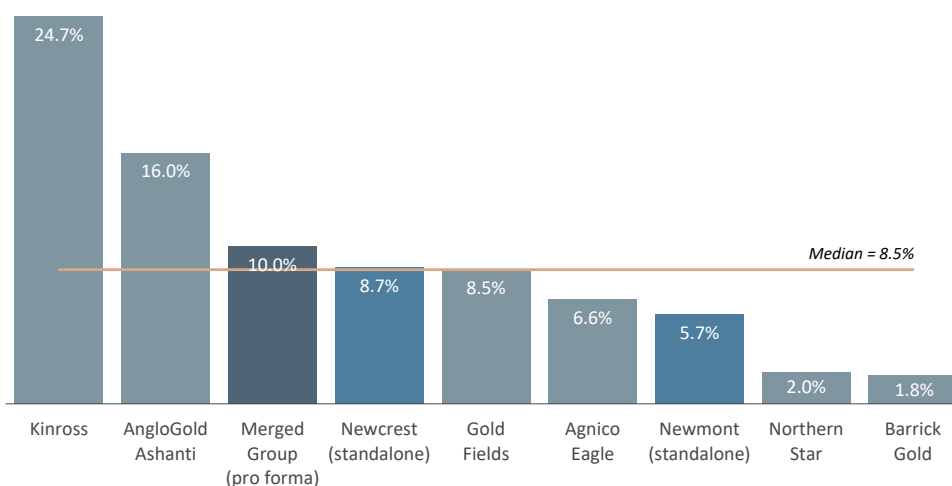

SELECTED LISTED GOLD PRODUCERS

GEARNG (NET BORROWINGS/ENTERPRISE VALUE)^{74,76}

Source: Grant Samuel analysis (see Appendix 5)

Each of the listed peers is a major gold producer, representing the largest constituents of the NYSE Arca Gold Producers Index⁷⁷ with similar characteristics in terms of the global scale and operational diversity and the same key driver of value (i.e. the gold price). However, there are still differences among the peers in terms of the:

- extent of assets located in tier 1 mining jurisdictions such as Australia, Canada and the United States compared to riskier locations with higher geopolitical risks such as Africa and parts of South America;
- proportion of gold versus other metals produced (e.g. Newcrest generated a meaningful 24% of its revenue from copper in FY23);
- organic growth outlook (i.e. exploration and development upside) and stage in the investment cycle, which impacts capital expenditure and therefore gearing and the ability to pay dividends to shareholders; and
- track record of performance in terms of growth in production and reserve replacement.

This analysis shows that:

- forecast EBITDA multiples are generally in the range 6-8 times (excluding outliers, see Appendix 5 for further discussion). The Merged Group pro forma forecast EBITDA multiples (pre and post synergies) are consistent with this range (albeit at the low end). The higher standalone forecast EBITDA multiple for Newmont possibly reflects the greater certainty in relation to forecast CY22 EBITDA at the date of calculation (i.e. 3 February 2023), which included three quarters of actual performance to 30 September 2022⁷⁵;
- the Merged Group pro forma forecast dividend yield of 4.1% is at the high end of the range of 2-4% and is consistent with Newmont's standalone dividend yield. To enable equivalent comparison, the forecast dividend yields for the Australian gold producers (Newcrest and Northern Star) have also been shown grossed up for franking credits as these companies have historically paid fully franked dividends; and

⁷⁶ Gearing is based on the latest publicly available net borrowings for each listed entity at the date the market capitalisation is calculated. For most of the listed entities net borrowings is at 30 June 2023. For Newcrest (standalone), net borrowings is at 30 June 2022 and for Newmont (standalone), net borrowings is at 30 September 2022.

⁷⁷ Excluding streaming/royalty companies (Franco-Nevada and Wheaton Precious Metals), Zijin Mining Group, which is primarily backed by a government owned entity and has the majority of its assets in China and Endeavour Mining, which operates solely in eastern Africa.

Annexure 1. Independent Expert's Report

GRANT SAMUEL



- all of the major gold producers have relatively low gearing ratios (based on the market value of equity). Excluding outliers, gearing ratios are generally less than 10% (see Appendix 5 for further discussion). The Merged Group pro forma gearing ratio of 10.0% is relatively high but not inconsistent with the gearing of its peers. It is higher than Newmont's standalone gearing ratio as a result of taking on Newcrest's net borrowings (and its relatively higher level of market value based gearing).

Based on the above analysis, there is no evidence to suggest that Newmont is trading (even since announcement of the Further Revised Proposal or the Newmont Transaction) materially out of line with its peer group. However, its relatively low forecast pro forma EBITDA multiples and relatively high forecast dividend yields suggest that there may be some scope for rerating.

Analyst Target Prices

The target price is generally an estimate by analysts of the trading price of shares in 12 (and sometimes up to 18) months' time. At Newmont's Latest Share Price of \$39.32, Newmont is trading well below the median analyst estimate of its target price of \$54.00:

NEWMONT – LATEST ANALYST TARGET PRICES AND RECOMMENDATIONS⁷⁸

ANALYST	DATE OF REPORT	CLOSING SHARE PRICE ⁷⁹	TARGET PRICE	STOCK RECOMMENDATION ⁸⁰	CLOSING SHARE PRICE DISCOUNT TO TARGET PRICE
Broker 1	4 September 2023	\$39.32	\$45.00	Outperform	-13%
Broker 2	31 August 2023	\$39.46	\$52.00	Hold	-24%
Broker 3	29 August 2023	\$39.04	\$42.00	Hold	-7%
Broker 4	21 August 2023	\$38.20	\$59.00	Hold	-35%
Broker 5	17 August 2023	\$38.29	\$44.00	Hold	-13%
Broker 6	16 August 2023	\$38.47	\$40.00	Hold	-4%
Broker 7	14 August 2023	\$40.19	\$52.00	Hold	-23%
Broker 8	14 August 2023	\$40.19	\$54.00	Outperform	-26%
Broker 9	13 August 2023	\$40.19	\$48.00	Hold	-16%
Broker 10	9 August 2023	\$39.84	\$68.49	Outperform	-42%
Broker 11	8 August 2023	\$40.48	\$61.00	Outperform	-34%
Broker 12	25 July 2023	\$43.23	\$50.00	Buy	-14%
Broker 13	25 July 2023	\$43.23	\$57.00	Buy	-24%
Broker 14	21 July 2023	\$42.45	\$55.00	Buy	-23%
Broker 15	21 July 2023	\$42.45	\$54.00	Buy	-21%
Broker 16	21 July 2023	\$42.45	\$60.00	Buy	-29%
Broker 17	21 July 2023	\$45.18	\$62.00	Outperform	-27%
Broker 18	20 July 2023	\$45.18	\$60.00	Buy	-25%
Broker 19	20 July 2023	\$45.18	\$63.00	Hold	-28%
Broker 20	20 July 2023	\$45.18	\$55.00	Buy	-18%
Broker 21	20 July 2023	\$42.65	\$44.00	Hold	-3%
<i>Low</i>		<i>\$38.20</i>	<i>\$40.00</i>		<i>-3%</i>
<i>High</i>		<i>\$45.18</i>	<i>\$68.49</i>		<i>-42%</i>
<i>Median</i>		<i>\$40.48</i>	<i>\$54.00</i>		<i>-23%</i>
<i>Average</i>		<i>\$41.48</i>	<i>\$53.59</i>		<i>-21%</i>

^{78,79,80} Bloomberg and Grant Samuel analysis

⁷⁸ Grant Samuel has excluded from its analysis eight brokers that have not published reports subsequent to the announcement of Newmont's 2Q23 results on 20 July 2023.

⁷⁹ Newmont's closing share price is for the day prior to the release of the analyst recommendation.

⁸⁰ Different broker's use different terminology for stock recommendations. The stock recommendations in the table are shown on an equivalent basis (i.e. hold is the same as market perform, sector perform, equal weight and neutral).

GRANT SAMUEL



However, the majority of analysts regard this price differential as a buying opportunity, with 11 out of 20 or 55% of analysts having a “buy” or “outperform” recommendation on Newmont shares and the remaining analysts having a “hold” recommendation. None of the analysts had a “sell” recommendation on Newmont shares.

It is unclear why Newmont shares are trading at such a large discount to target prices although analyst price targets are typically well above current trading levels. It may be that the current share price is a reflection of short term impacts such as weaker than expected 2Q23 results whereas the target prices take a longer term (i.e. 12 to 18 month) view on the Newmont share price including improving longer term costs as inflationary pressures decline and production levels increase and, possibly, the impact of the acquisition of Newcrest, including its strategic importance and the anticipated synergies. Newmont has demonstrated its ability to deliver synergies through its acquisition of Goldcorp (annual synergies of more than \$1 billion delivered over the past four years).

While the analysis could indicate that the current share price is undervalued, brokers are more likely to be taking a longer term view on Newmont's share price. The analyst target prices do provide some support for stronger trading in Newmont shares in the months after implementation of the Newmont Transaction (although this is less relevant to an assessment of the realisable value of the consideration at the time that the Newmont Transaction is implemented).

Liquidity

Newmont is a highly liquid stock with high trading volumes. It is a member of a number of major stockmarket indices and is the only gold producer included in the S&P 500 Index. It is also the second largest member of the NYSE Arca Gold Miners Index with a weighting of around 8%.

Average weekly volume over the twelve months prior to announcement of the Revised Proposal represented approximately 5% of average shares on issue or annual turnover of around 265% of total average issued capital. Average weekly volume for Newmont shares over various periods prior to and following announcement of the Revised Proposal on 6 February 2023 are summarised below:

NEWMONT – SHARE TRADING

PERIOD	AVERAGE WEEKLY VOLUME (‘000 SHARES)
4 February 2022 to 3 February 2023 (year prior to announcement of Revised Proposal)	40,377
4 August 2022 to 3 February 2023 (six months prior to announcement of Revised Proposal)	40,257
4 November 2022 to 3 February 2023 (three months prior to announcement of Revised Proposal)	35,058
4 January 2023 to 3 February 2023 (month prior to announcement of Revised Proposal)	35,657
6 February 2023 to 1 September 2023 (post announcement of Revised Proposal)	39,205
11 April 2023 to 1 September 2023 (post announcement of Further Revised Proposal)	37,187
15 May 2023 to 1 September 2023 (post announcement of Newmont Transaction)	36,709

Source: Bloomberg and Grant Samuel analysis

The lower average weekly trading volume over periods including the Thanksgiving and Christmas/New Year period (from November 2022 to January 2023) is not unexpected and is a pattern that is consistent with trading in Newmont shares in prior years.

There has been no material change in the average weekly volume of shares traded over periods following announcement of the Revised Proposal. Since announcement of the Revised Proposal, average weekly

Annexure 1. Independent Expert's Report

GRANT SAMUEL



volumes in Newmont shares have been up to 9% lower than trading during the six and 12 months prior to announcement of the Revised Proposal.

These differences in trading volumes are not material and there is nothing in the analysis that indicates any abnormal trading in Newmont shares.

Non Public Information

Similar to the disclosure requirements for ASX-listed companies, as a NYSE-listed company, Newmont has disclosure and reporting obligations to both the NYSE and the SEC. Generally, a listed company is required to keep the market informed of events and developments in a timely manner as they occur. Once Newmont becomes aware of any information concerning it that a reasonable person would expect to have a material effect on the price or value of its securities or influence investment decisions, it must inform the market of that information. The NYSE also seeks to ensure that listed companies provide timely and regular financial information.

Newmont announced its financial results for CY22 (which incorporated CY23 and certain longer term guidance) on 23 February 2023, for 1Q23 (which confirmed CY23 guidance) on 27 April 2023 and for 2Q23 (and 1HY23) on 20 July 2023.

Newmont also disclosed to the market confirmation of the Revised Proposal on 5 February 2023, the Further Revised Proposal and entry into confirmatory due diligence on Newcrest on 10 April 2023 and entry into the Newmont Transaction on 14 May 2023 (all New York time).

Consequently, there is no reason to consider that any information relating to Newmont's existing business that would have a material impact on its share price has not been publicly disclosed.

6.4 Impact of the Newmont Transaction

Strategic Benefits

The acquisition has strategic benefits for Newmont in that it:

- creates a world class portfolio of assets, with the highest concentration of tier 1 assets (10 in total), primarily in favourable and low-risk mining jurisdictions;
- sets a new benchmark in gold production, with pro forma CY22 attributable gold production of approximately 8Moz (a 34% increase from Newmont's CY22 gold production), underpinned by the gold sector's largest resource and reserve base (of around 150Moz and 335Moz respectively);
- provides a material and growing exposure to copper, a metal that has a strong long term outlook due to global electrification and accelerating decarbonisation. The acquisition of Newcrest adds almost 17 billion pounds of copper reserves and nearly 50 billion pounds of copper resources to Newmont's portfolio of assets and delivers a combined annual copper production of approximately 385 million pounds (a more than 350% increase from Newmont's CY22 copper production of 84 million pounds);
- delivers an extensive portfolio of greenfield and brownfield growth options, including projects across some of the world's most prospective regions such as Canada's Golden Triangle (Red Chris and Brucejack);
- provides the opportunity to generate efficiencies and cost savings from Newmont's scalable, integrated operating model. Newmont has estimated annual pre-tax synergies of \$500 million that are expected to be achieved within the first 24 months. In addition, Newmont expects near term cash flows to be enhanced through targeting at least \$2 billion from portfolio optimisation across the Merged Group (i.e. flexibility in project sequencing and growth optionality) in the first two years; and
- supports Newmont's capital allocation strategy. The Merged Group balance sheet is supported by an even stronger, lower cost, diversified portfolio focused in low-risk mining jurisdictions, with the

GRANT SAMUEL



world's largest resource and reserve base able to advance its most value-accretive development opportunities and sustainably improve overall returns to shareholders.

Financial Implications

The pro forma financial implications for Newmont of the acquisition of Newcrest (including underlying assumptions) are set out in Section 7.7 of the Scheme Booklet and are summarised below:

PRO FORMA IMPACT OF NEWMONT TRANSACTION ON NEWMONT'S FINANCIAL PARAMETERS

	NEWMONT ACTUAL	MERGED GROUP PRO FORMA (PRE-SYNERGIES)	MERGED GROUP PRO FORMA (POST-SYNERGIES)
<i>Shares on issue (period end) (millions)</i>	795	1,153	1,153
<i>Weighted average shares (millions)</i>	794	1,152	1,152
Financial performance for CY22			
Sales	11,915	16,418	16,418
Adjusted EBITDA ⁸¹	4,550	6,692	7,192
Adjusted net income from continuing operations attributable to Newmont securityholders ^{81,82}	1,468	2,282	2,618
<i>Adjusted EBITDA margin</i>	38.2%	40.8%	43.8%
<i>Basic EPS (continuing operations before adjustments)</i>	\$1.85	\$1.98	\$2.27
<i>DPS (declared)</i>	\$2.05	\$2.05	\$2.05
<i>Interest cover</i>	10.4x	9.3x	10.6x
Financial performance for 1HY23			
Sales	5,362	7,718	7,718
Adjusted EBITDA	1,900	3,015	3,265
Adjusted net income from continuing operations attributable to Newmont securityholders ⁸²	586	1,066	1,239
<i>Adjusted EBITDA margin</i>	35.4%	39.1%	42.3%
<i>Basic EPS (continuing operations before adjustments)</i>	\$0.74	\$0.93	\$1.08
<i>DPS (declared)</i>	\$0.80	\$0.80	\$0.80
<i>Interest cover</i>	8.4x	8.1x	9.2x
Financial position at 30 June 2023 (\$ million)			
Total assets	38,133	59,243	
Total liabilities	(18,718)	(25,873)	
Net assets	19,415	33,370	
Non-controlling interests	(190)	(190)	
Net assets attributable to Newmont securityholders	19,225	33,180	
Net borrowings (including lease and other financing obligations)	(2,908)	(5,074)	
NTA	17,444	29,832	
<i>NTA per share</i>	\$21.95	\$25.89	
<i>Net borrowings/adjusted EBITDA⁸³</i>	0.7x	0.9x	0.8x
<i>Gearing</i>	13.0%	13.2%	

Source: Scheme Booklet and Grant Samuel analysis

⁸¹ Pro forma CY22 adjusted EBITDA and pro forma CY22 adjusted net income from continuing operations attributable to Newmont shareholders are before \$557 million of pro forma adjustments that relate to transaction costs and other one-time charges. The after-tax amount of these pro forma adjustments is \$510 million.

⁸² The Merged Group pro forma (post synergies) adjusted net income from continuing operations attributable to Newmont shareholders assumes that the \$500 million of synergies attract a pro forma Merged Group adjusted effective income tax rate of 33% in CY22 and 31% in 1HY23.

⁸³ Pro forma adjusted EBITDA for the prior 12 months has been estimated based on the half year contributions of Newcrest and Newmont to the Merged Group and applying the same percentage contribution to the pro forma adjustments.

Annexure 1. Independent Expert's Report

GRANT SAMUEL



The pro forma analysis indicates that the Newmont Transaction has the following impacts on Newmont:

- it substantially increases the size of Newmont. There is a 38% increase in pro forma CY22 sales and a 47% increase in pro forma CY22 adjusted EBITDA before synergies (increasing to 58% after synergies). Pro forma total assets at 30 June 2023 increase by 55% and pro forma net assets increase by 72%;
- it is accretive to pro forma CY22 EPS (from continuing operations before adjustments), in the order of 7% before synergies although the differential increases to 23% after synergies. The accretion is more pronounced in 1HY23 at 25% before synergies and 46% after synergies. The pro forma accretion to EPS is before taking into account the impact on earnings from portfolio optimisation across the Merged Group that Newmont expects to deliver in the first two years post implementation;
- pro forma gearing at 30 June 2023 (based on the book value of equity) increases marginally from 13.0% to 13.2% and pro forma CY22 net borrowings/adjusted EBITDA also increases to 0.9 times before synergies, but falls to 0.8 times after synergies, remaining within Newmont's target of less than 1.0 times. Pro forma CY22 interest cover falls from 10.4 times to 9.3 times before synergies but improves to 10.6 times after synergies. The Merged Group's pro forma balance sheet does not include a pro forma adjustment for transaction costs and other one-time charges (of \$510 million after tax) as these are assumed to have been expensed in CY22 (which is required for US GAAP purposes). Including transaction and other one-time charges as a pro forma adjustment to the Merged Group's balance sheet would increase pro forma gearing at 30 June 2023 to 14.5% and pro forma CY22 net borrowings/adjusted EBITDA to 0.9 times (pre synergies and post synergies), still within Newmont's target; and
- pro forma NTA per share at 30 June 2023 increases from \$21.95 to \$25.89 (or to \$24.60 if allowance is made for the transaction costs and other one-time charges).

Newmont has committed to maintaining its dividend framework based on the gold price and its guidance of a CY23 dividend of \$1.60-180 per share is not expected to change as a result of Newmont Transaction.

Impact on the Newmont Share Price

While the market has been aware of the strategic benefits of the Newmont Transaction since it was announced in April 2023, there has been limited financial information available on the Merged Group (prior to the release of the Scheme Booklet). The financial information disclosed in the Scheme Booklet and summarised above indicates accretion in pro forma EPS (from continuing operations before adjustments) for the Merged Group for CY22 before synergies relative to CY22 EPS (from continuing operations before adjustments) for Newmont on a standalone basis. Furthermore:

- both Newmont and Newcrest are large enough to be closely followed by analysts and many will have already been able to estimate the Merged Group's pro forma financial information with a reasonable degree of accuracy (although this will have been made more complicated by adoption of a 31 December 2022 year end and US GAAP across the Merged Group). In any event, the impacts are not that dramatic (on a continuing operations before adjustments basis); and
- the market is focused on prospective earnings and Newmont's share price should also reflect the market's assessments of the medium term upside potential from achieving the expected synergies (which, if achieved, would have a substantial accretive impact on EPS (from continuing operations before adjustments)) as well as the cash flow impact from portfolio optimisation, both of which have been disclosed to the market for some time.

Accordingly, the Newmont share price should already reflect the impact of the Newmont Transaction.

6.5 Conclusion

Grant Samuel's judgement is that a Newmont share price of \$40.00-44.00 is a reasonable estimate in current market conditions (including the current gold price) of the share price if the Newmont Transaction



GRANT SAMUEL



is implemented. This range takes into account the recent performance of Newmont shares and the financial impact of the acquisition of Newcrest. In particular:

- it reflects the range of trading prices since announcement of the Further Revised Proposal on 10 April 2023 (New York time) (\$37.84-51.46, at a VWAP of \$43.52) and, more particularly, since the announcement of the Newmont Transaction on 15 May 2023 (\$37.84-47.45, at a VWAP of \$41.89). Newmont's Latest Share Price of \$39.32 was only slightly below the low end of the range;
- while there has been a sustained decline in Newmont's share price since announcement of the Further Revised Proposal and the Newmont Transaction, there is no specific evidence to suggest that recent Newmont share prices do not reflect the rational view of a well informed market or that Newmont is trading materially out of line with its peers or the market. In this regard:
 - some market parameters are at the low (EBITDA multiples) or high (dividend yields) ends of the range compared to peers; and
 - broker's target prices are well in excess of current market prices.

While these factors indicate that there is the potential for improvement in Newcrest's share price, this is relevant to longer term Newmont share prices (e.g. in 12 months' time) rather than the share price at the time that the Newmont Transaction is implemented; and

- companies such as Newmont and Newcrest are relatively transparent entities and sufficient information has been disclosed to enable analysis of the impact of the acquisition on Newmont. As the market has had sufficient opportunity to absorb that information, the impact of the acquisition of Newcrest should be reflected in Newmont's share price even though uncertainty remains as to whether Newmont will succeed in acquiring Newcrest.

While the range is relatively wide, it reflects the inherent volatility in the Newmont share price over the past 12 months.

The assessed value of the Scheme consideration relative to recent Newmont share prices is show below:

ASSESSED VALUE OF SCHEME CONSIDERATION VS NEWMONT SHARE PRICE
1 SEPTEMBER 2022 TO 1 SEPTEMBER 2023



Source: Bloomberg

The value range assumes continuation of current market conditions (at the date of this report), including current gold prices (although to the extent that there was a material increase in the gold price, this would also result in an increase in the valuation of Newcrest).

GRANT SAMUEL



7 Evaluation of the Newmont Transaction

7.1 Opinion

In Grant Samuel's opinion, the Newmont Transaction (including the Scheme) is in the best interests of Newcrest shareholders in the absence of a superior proposal.

7.2 Summary

Assessment of the Newmont Transaction is not straightforward. Even at the best of times valuation of Newcrest is subject to considerable uncertainty and involves a high level of subjective judgement, particularly in relation to development projects and/or assets with sovereign risk. The challenges are exacerbated when the valuation is at a "point in time" but the market pricing of gold equities (which reflect key drivers such as gold price, operating costs and cost of equity, albeit in an indeterminable manner) has been highly volatile over the last few months. A wide range of valuation conclusions could credibly be reached. Accordingly, fundamental valuation analysis should be treated with caution. Other considerations such as market based measures of relative contribution of Newcrest to the Merged Group and other factors are also useful and relevant. The assessment of the Newmont Transaction is an overall conclusion having regard to all of these considerations.

Grant Samuel has valued Newcrest in the range \$16.7-18.9 billion, or \$18.64-21.13 per share. The valuation reflects the full underlying value of Newcrest's mineral assets and exceeds the price at which, given current gold prices and market conditions, Newcrest shares would be expected to trade in the absence of the Newmont Transaction or speculation regarding some alternative corporate transaction.

Assessment of the consideration is based on the "cash equivalent" value of the Scheme consideration offered by Newmont. The value of the consideration was \$21.54 per Newcrest share based on the Newmont closing share price on the day prior to announcement of the Further Revised Proposal (\$51.09) and \$19.48 per Newcrest share based on the Newmont closing share price on the day prior to announcement of the Newmont Transaction (\$45.94) and was, on both of these dates, demonstrably "fair" (although it is not now based on current Newmont share prices).

However, Grant Samuel's opinion is directed to the issue of whether or not Newcrest shareholders are receiving fair value for their shares today. The Newmont share price has declined substantially since announcement of the Further Revised Proposal in April 2023, falling from \$51.09 to current prices of around \$40 (a decline of over 20%). On the basis of recent trading on the NYSE and various other factors, Grant Samuel has adopted a Newmont share price trading range of \$40.00-44.00. The width of the range reflects the recent volatility in Newmont's share price and while it is above the Latest Share Price (\$39.32), it is in line with recent trading. Accordingly, Grant Samuel has assessed the value of the consideration under the Newmont Transaction to be \$17.10-18.70 per Newcrest share⁸⁴.

The assessed value of the consideration under the Newmont Transaction of \$17.10-18.70 per Newcrest share overlaps Grant Samuel's estimate of the full underlying value of Newcrest of \$18.64-21.13 per share, but only marginally. While it could be argued that any amount of overlap results in a transaction being "fair", in Grant Samuel's view, the extent of the overlap in this case is insufficient to meet the requirements for the Newmont Transaction to be "fair" in terms of ASIC's regulatory guidelines, particularly as Newmont's Latest Share Price (\$39.32) represents consideration of only \$16.83 per Newcrest share.

However, there are good reasons to conclude that this analysis provides at best an incomplete assessment of the Newmont Transaction, given its scrip nature and the overall volatility in market values across the gold sector in recent months. A shareholder could validly take the view that:

⁸⁴ For some shareholders (e.g. Australian resident shareholders), franking credits increase the effective after tax value of the consideration (see Section 7.4.2).

G R A N T S A M U E L



- the transaction could be viewed as a scrip based merger;
- the Further Revised Proposal was demonstrably fair when it was announced on 10 April 2023 (New York time) (although it is not now based on current Newmont share prices). While Newmont's shares have fallen by 23% since 10 April 2023, the other major gold miners⁸⁵ have also fallen materially, by approximately 18% on average, over this same period. Accordingly, Newmont has only underperformed by circa 5%. One perspective is that if the Newmont Transaction was a "good deal" when it was first announced in April 2023 it is still likely to be a good deal now, even if the terms are effectively somewhat less attractive on a relative basis (i.e. to the extent of Newmont's underperformance); and
- Grant Samuel's valuation of Newcrest is at a point in time and is a subjective view of value. In contrast, the sharemarket provides an unbiased view of value that represents a consensus of thousands of market participants.

Relative contributions analysis over an extended period from 1 June 2022 to 3 February 2023 shows that Newcrest shareholders consistently contributed ~25% of the combined sharemarket value yet they are receiving ~32% of the Merged Group (taking into account the special dividend), representing a premium (or uplift) of around 30%.

This premium might be regarded as more meaningful because it is not a reflection of estimates of absolute values at one point in time.

While the premium may have diminished to the extent that Newmont's share price has underperformed against the broader gold sector since announcement of the Further Revised Proposal, Newcrest shareholders are still receiving a substantial premium if it is assumed that Newcrest shares would have performed in line with its listed peers absent announcement of the Newmont Transaction. For this analysis to be valid, the market for Newmont and Newcrest shares needs to be well informed and well traded. In Grant Samuel's opinion, there is no reason to believe this is not the case.

In a broader sense, the Newmont Transaction enables Newcrest shareholders to retain their direct exposure to the gold sector by "rolling up" their investment into a larger, more diversified company (the world's largest gold miner), while capturing a meaningful premium (through the uplift in their share of the Merged Group) in the process, as well as benefitting from a higher dividend per share.

On this basis, it could be argued that the Newmont Transaction provides an exchange ratio that is equitable. In any event, irrespective of the merits of this argument, it underpins "reasonableness". In addition:

- at the date of this report, Newmont shares are trading at 10 month lows and there are other factors that could suggest that there is some upside in the Newmont share price from these levels, such as a low forecast EBITDA multiple and high dividend yield relative to its peers.

Similarly, while the \$500 million per annum of synergies that Newmont expects to achieve across the Merged Group might be reflected in its market price to some extent they will inevitably be risk weighted. If Newmont is able to achieve these synergies (and it has demonstrated its ability to deliver synergies through its acquisition of Goldcorp) there is likely to be a positive share price response. An additional \$500 million of EBITDA is theoretically worth around \$3 billion⁸⁶, or \$2.60 per Merged Group share.

⁸⁵ Based on an index created by Grant Samuel comprising major gold producers excluding Newmont and Newcrest.

⁸⁶ Calculated as \$500 million x 6.0 times (the pro forma forecast EBITDA multiple (post synergies) for the Merged Group. See Section 6.3.

Annexure 1. Independent Expert's Report

GRANT SAMUEL



At the same time, there can be no guarantee that the Newmont share price will strengthen and in any event, such an increase in the Newmont share price represents value in the future rather than value today;

- Newmont's offer is "best and final", and therefore it cannot be increased in the absence of a superior proposal from an alternative acquirer;
- there are relatively few potential acquirers that have the scale and financial capacity to acquire Newcrest. Interest from financial buyers such as private equity funds is highly unlikely given Newcrest's commodity exposure (and scale). Any interest is likely to come from either other gold sector participants or diversified miners. However:
 - diversified miners are likely to view gold as a "niche" sector and prefer to focus on sectors such as iron ore and aluminium or "future facing" metals such as copper or nickel. Equally, investors are likely to prefer a "pure" exposure to gold rather than one buried in a larger portfolio of assets;
 - there are only two listed gold companies (apart from Newmont) that have a market capitalisation larger than Newcrest. It is quite conceivable that, if the Newmont Transaction does not proceed, shareholders do not receive any acquisition proposal from any other party within their investment horizon. In this context, Newcrest's exposure to PNG may be a deterrent to some acquirers;
 - in view of the relativities in size, any proposal from another gold miner would almost certainly involve a substantial scrip component. In this situation, it would be challenging for an acquirer to pay a significant premium because of the dilutionary impact on its own shareholders and it would face many of the same issues afflicting the Newmont Transaction. Indeed, it is possible that any alternative transaction would be structured as a mergers of equals (which a large proportion of recent consolidation transactions in the sector have been), in which case Newcrest shareholders might not receive any premium for control; and
 - in a scrip based transaction, synergy benefits are often a meaningful driver of value. The complementarity between Newmont's and Newcrest's asset portfolios mean that Newmont is probably in a position to generate significantly more synergies than other acquirers (and Newcrest shareholders share in 31% of those synergies, to the extent realised);
- any potential alternative acquirer has had ample time to consider an acquisition proposal for Newcrest (since 6 February 2023) and the decline in the Newmont share price has opened a real "window of opportunity". If a superior alternative acquisition proposal does not arise prior to the Scheme meeting it would be reasonable to conclude that the Newmont Transaction delivers the best available value to Newcrest shareholders; and
- in the absence of the Newmont Transaction (or an alternative proposal or speculation as to an alternative proposal), it is likely that the Newcrest share price would fall, at least in the short term. Prior to announcement of the Revised Proposal on 3 February 2023, Newcrest shares were trading at around A\$22 (equivalent to ~\$15) (i.e. the "undisturbed" price). Since 3 February 2023, the listed gold sector⁸⁵ has fallen by approximately 7%. It is therefore likely that the Newcrest share price would also be lower now than it was prior to announcement of the Revised Proposal and, in the absence of any upward movement in the gold price, it may take some time for Newcrest's share price to increase to the levels implied by the Newmont Transaction.

While none of these alternative analyses or other factors are individually compelling, collectively they would justify Newcrest shareholders voting in favour of the Scheme.

The realisable value of the consideration will fluctuate with movements in the Newmont share price. The real test is the price at the time of the Scheme meeting on 13 October 2023. At that point, the realisable value of the consideration under the Newmont Transaction may be greater or less than the range of values assessed by Grant Samuel (\$17.10-18.70 per Newcrest share). The recent volatility in the Newmont share

GRANT SAMUEL



price would suggest that shareholder decisions should be left as late as practically possible. If the Newmont share price recovers during this period, it could change Grant Samuel's views on fairness, although Grant Samuel's opinion would, in any event, still be that the Newmont Transaction is in the best interests of shareholders.

If a superior proposal does not emerge prior to the Scheme meeting, the choice is essentially between the Newmont Transaction and the status quo. In this case, Grant Samuel's judgement is that the Newmont Transaction (including the Scheme) would be in the best interests of Newcrest shareholders.

7.3 Fairness

Value of Newcrest

Grant Samuel has estimated the full underlying value of Newcrest to be in the range \$16.7-18.9 billion, which corresponds to \$18.64-21.13 per share (cum the special dividend). The value is the aggregate value of the underlying value of Newcrest's mineral assets together with the realisable value of non-trading assets less external borrowings and any non-trading liabilities.

The principal approach to valuing Newcrest's mineral assets was by DCF analysis. The NPV outputs for the producing mineral assets (Cadia, Lihir, Telfer, Red Chris and Brucejack) and advanced development projects (Wafi-Golpu) were estimated based on two production scenarios developed in conjunction with, and reflecting the technical judgement of, the independent technical specialist, AMC. Technical valuation assumptions (e.g. production and processing rates, metal grades and recovery rates, operating and capital costs and closure costs) for each scenario were reviewed in detail, and estimated, by AMC. Grant Samuel determined key assumptions as to commodity prices, exchange rates and discount rates.

Grant Samuel then determined an appropriate value range for each asset reflecting the NPV outcomes of the various scenarios, the evidence from other methodologies (e.g. multiples of earnings and resources) and various other factors such as location (sovereign risk), development status (development risk), resource upside and optionality. The value is not based on any one scenario or set of assumptions.

The valuation range of \$18.64-21.13 per share includes a premium for control and exceeds the price at which, based on current market conditions, Grant Samuel would expect Newcrest shares to trade on the ASX in the absence of a change of control proposal (or speculation as to such a proposal).

Grant Samuel's valuation includes an allowance for synergies (cost savings) that could be achieved by any acquirer of Newcrest (primarily corporate overheads). However, "fair value" does not include the synergies that are unique to one particular party only (i.e. in this case Newmont) and it is therefore not appropriate to include synergies uniquely available to Newmont in the valuation of Newcrest.

The valuation is set out in Section 4 of this report.

Assessment of the Market Value of the Consideration

Under the Newmont Transaction, Newcrest shareholders (other than ineligible foreign shareholders¹) will receive, for each Newcrest share held:

- the Scheme consideration of 0.400 Newmont securities²; and
- \$1.10 in cash, expected to take the form of a franked³ special dividend paid by Newcrest on or around implementation of the Scheme.

ASIC Regulatory Guide RG111 requires the Scheme consideration to be assessed:

- assuming the transaction is completed;
- based on the value shareholders are receiving today rather than at the time of announcement; and

Annexure 1. Independent Expert's Report

GRANT SAMUEL



- on a “minority interest” basis in the case of a change of control transaction. The best estimate of a minority interest is the market price of the Scheme consideration on stock exchanges (but subject to determining that this market price is not distorted or unreliable).

The analysis is directed to the “cash equivalent” value of the Scheme consideration. It is an entirely separate matter for individual shareholders to determine whether to hold or sell the Newmont securities that they receive under the Newmont Transaction, which is a separate investment decision for individual shareholders with much broader ramifications.

Having regard to these requirements, Grant Samuel has attributed a value of \$16.00-17.60 per Newcrest share to the Scheme consideration based on an estimated market value for Newmont shares of \$40.00-44.00 based on recent trading. While the Latest Share Price (\$39.32) is slightly below the bottom of this range, Grant Samuel believes it is appropriate based on recent trading patterns (Newmont shares have traded at levels below \$40.00 per share only on rare occasions over the past 12 months).

Accordingly, the value of the consideration under the Newmont Transaction is \$17.10-18.70 per Newcrest share (including the special dividend of \$1.10 per share). The assessment of the value of the consideration is set out in Section 6 of this report.

The realisable value of the consideration will fluctuate with movements in the Newmont share price. The actual value received by Newcrest shareholders may ultimately be greater or less than the range of values assessed by Grant Samuel of \$17.10-18.70 per Newcrest share.

Currency

As both the value of the consideration and the control value of Newcrest have been estimated in US dollars, movements in the A\$/US\$ exchange rate do not have a direct impact on the analysis although such movements would impact:

- the control value of Newcrest to the extent that cash flows are denominated in Australian dollars and are unhedged; and
- the Australian dollar consideration received by Newcrest shareholders to the extent that they choose to:
 - convert the special dividend received to Australian dollars; and/or
 - sell the Newmont securities at some future time.

Analysis and Conclusion

The assessment of the Newmont Transaction is complicated and challenging. The valuation of Newcrest is a view at a single point in time but it is not necessarily a static value as it can shift daily reflecting gold price movements (which go directly to value) as well as other factors. It is not as stable as a valuation of a typical industrial company. These uncertainties are exacerbated by volatility of the market prices of gold equities in recent months. There has been a significant downward shift since April 2023 possibly reflecting factors such as adverse news in relation to operating (and capital) costs and/or changing investor return requirements (albeit that the precise reasons are essentially unknowable).

Based on the Newmont closing share price on the day prior to announcement of the Further Revised Proposal (of \$51.09) and the Newmont Transaction (of \$45.94), the consideration had a value of \$21.54 and \$19.48 and was therefore within or above Grant Samuel's valuation range for Newcrest at those times.

However, the Newmont share price has fallen significantly since announcement of the Further Revised Proposal and it is recent Newmont share prices that are most relevant in assessing the value of the consideration under the Newmont Proposal.

The value attributed to the consideration under the Newmont Transaction compared to Grant Samuel's estimate of the full underlying valuation range of Newcrest is illustrated in the chart below:



GRANT SAMUEL



NEWCREST – COMPARISON OF VALUE RANGE

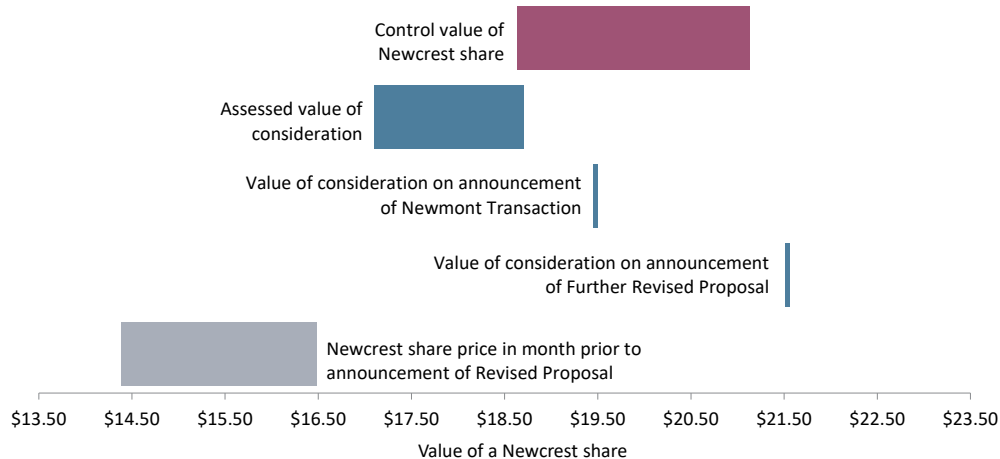

In evaluating the fairness of the Newmont Transaction, it needs to be recognised that the bottom of the valuation range for Newcrest (i.e. \$18.64) represents the relevant threshold for fairness. Usually (and particularly for a cash offer), the value of the consideration would only need to be above the bottom end of the valuation range for the transaction to be “fair”.

However, the Newmont Transaction is predominantly a scrip offer and Grant Samuel’s assessment of the value of the consideration is based on a range of trading values for Newmont shares. As can be seen in the chart, only a small portion of the assessed value of the consideration falls within the valuation range.

There is no formal rule about the extent of overlap required between the valuation of the target company and the assessed value of the consideration for an offer to be regarded as “fair”. There have been cases where the slightest overlap has been regarded as sufficient to meet the fairness criteria⁸⁷.

On the other hand:

- the overlap is minimal;
- despite the overlap of the ranges the reality is that, at Newmont’s Latest Share Price of \$39.32, the consideration has a value of \$16.83 per Newcrest share, \$1.81 or 10% below the bottom end of the estimated underlying value range of \$18.64. Similarly, the VWAP over the previous month gives a value for the consideration of only \$16.89, also well below the bottom of the range;
- a Newmont share price of \$43.85 is required to equate to the bottom of the value range. Other than for a brief period prior to the announcement of its 2Q23 results, Newmont shares have not traded above this level since mid-May 2023; and
- it is not necessarily appropriate to compare the top of the assessed value of the consideration range with the bottom of the estimated underlying value range as they arguably reflect different commodity price scenarios.

In Grant Samuel’s view, the Newmont Transaction does not meet the requirements to be “fair” in terms of ASIC’s regulatory guidelines. Newcrest shareholders will not receive full underlying value under the Newmont Transaction.

⁸⁷ See, for example, the independent expert’s report dated 29 February 2016 on the merger of STW Communications Limited (“STW”) with the Australian and New Zealand businesses of WPP plc (“WPP ANZ”), effected through the acquisition by STW of the shares in WPP ANZ by the issue of shares in STW to WPP plc (as a result of which WPP plc’s interest in STW increased from 23.55% to 61.5%). The overlap between the independent expert’s underlying value of STW shares and the assessed value of the combined group shares after the proposed merger was marginal (at only A\$0.01 cent or 7%) and the independent expert concluded that the transaction was “fair”. The transaction was approved by the non-associated shareholders.

Annexure 1. Independent Expert's Report

GRANT SAMUEL



However, both the valuation of Newcrest and the assessment of the market value of the Scheme consideration are subject to material uncertainty. Shareholders could reasonably reach different conclusions based on the same information (which is set out in Sections 4 and 6 of this report).

Decision Timing

The Scheme Meeting (when shareholders will vote on the Scheme) is scheduled to be held on 13 October 2023, and the Newmont securities they receive as Scheme consideration (if the Scheme is implemented) will not be received until early November 2023. The Newmont share price will continue to change on a daily basis. Accordingly, shareholders should continue to monitor the Newmont share price. Given the volatility any decision should be made as late as possible.

The impact of movements in the Newmont share price on the value of the consideration is illustrated in the following table:

NEWMONT TRANSACTION – VALUE OF CONSIDERATION

NEWMONT SHARE PRICE	VALUE OF CONSIDERATION
\$34.00	\$14.70
\$36.00	\$15.50
\$38.00	\$16.30
\$40.00	\$17.10
\$42.00	\$17.90
\$44.00	\$18.70
\$46.00	\$19.50
\$48.00	\$20.30
\$50.00	\$21.10

It is conceivable that that Newmont share price could recover over the period prior to the Scheme meeting. If it was a sufficiently material recovery, that could result in the Newmont Transaction becoming fair, although that would not lead to any change in the opinion (as Grant Samuel has already concluded that the Newmont Transaction is in the best interests of shareholders).

However, it should be noted that the value of the consideration and the value of Newcrest are both exposed to movements in metal prices, particularly gold. Revenue from gold sales represents more than 85% of Newmont's CY22 revenue and around 75% of Newcrest's FY23 revenue, changes in gold prices are likely to have a similar directional impact on the market value of Newmont shares and the control value of Newcrest (albeit to slightly different extents). Accordingly, increases in the Newmont share price due to an increase in the gold price (to the extent it can be attributed) should be treated with caution.

7.4 Alternative Framework for Assessing the Newmont Transaction

There are good reasons to conclude that the analysis set out in Section 7.3 provides at best an incomplete assessment of the Newmont Transaction, given its scrip nature and the overall volatility in market values across the gold sector in recent months.

Grant Samuel's valuation of Newcrest is at a point in time and is a subjective view of value. In contrast, the sharemarket provides an unbiased view of value that represents a consensus of thousands of market participants. Another way for Newcrest shareholders to analyse the Newmont Transaction is in terms of the proportion of the Merged Group to be held by each group of shareholders relative to their respective contributions.

While there is a "change of control" of Newcrest, on implementation of the Newmont Transaction, Newcrest shareholders will, in aggregate, own 31% of the Merged Group and Newmont shareholders will, in aggregate, hold a 69% interest in the Merged Group. There will be no controlling shareholder and



GRANT SAMUEL



Newcrest shareholders will retain the opportunity to receive a control premium at some time in the future (although the prospects of the Merged Group receiving an offer would be remote given its size).

When listed companies are combined in a “merger”, relative contributions are typically assessed in terms of market values based on share prices (as sharemarket prices provide an objective measure of the value of each company) as well as other parameters such as earnings and assets (as well as reserves, resources and production in the case of resources companies). Relative contribution analysis on these bases for the Newmont Transaction are set out below and support the argument that the Newmont Transaction provides an exchange ratio that is equitable.

MARKET VALUES

Sharemarket values provide an objective measure of the contributions of value to the Merged Group to be made by each of Newcrest and Newmont shareholders. A relevant question however in this context is whether the Newcrest and Newmont share prices in the period before announcement of the Newmont Transaction appropriately reflected the fair market value of each company. They are both subject to continuous disclosure regimes, there is a relatively deep and liquid market in their shares and there is a substantial following by analysts. On this basis, a default assumption would be that the share market price is an appropriate reflection of fair value. It may be argued that a number of Newcrest’s assets are inherently difficult for the market to value (whether because of factors such as exposure to sovereign risk, potential for operational turnaround or development potential not yet fully foreshadowed in Newcrest’s market disclosures). On the other hand, a subjective valuation such as that prepared by Grant Samuel is not necessarily better equipped to deal with such issues. Overall, Grant Samuel believes that it is reasonable to conclude that the Newmont and Newcrest share prices prior to the announcement of the Newmont Transaction appropriately reflected the fair market values.

Newcrest’s contribution to the aggregate sharemarket value of the two companies (based on daily closing prices) compared to the share of the combined sharemarket value received by Newcrest shareholders (based on trading from 1 June 2021 to 3 February 2023, the last trading day prior to announcement of the Revised Proposal) is shown in the following chart:

NEWMONT TRANSACTION – NEWCREST SHARE OF COMBINED MARKET VALUE
JUNE 2021 TO FEBRUARY 2023

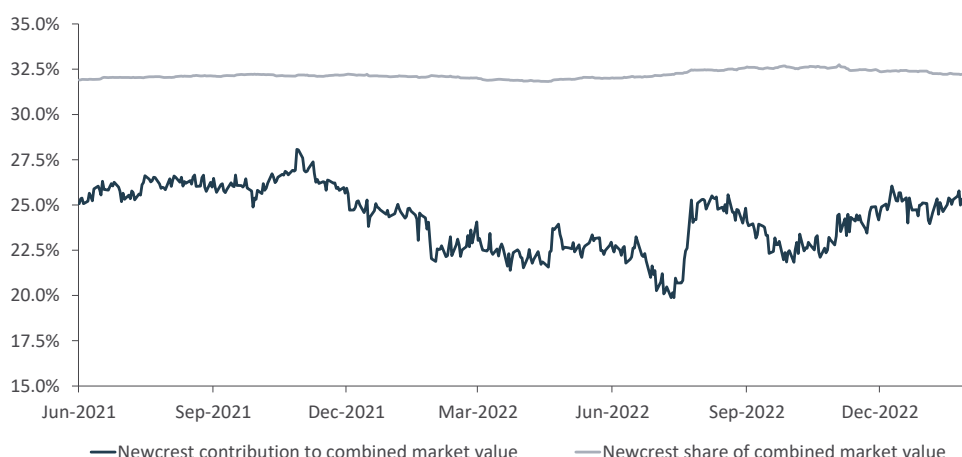

Source: IRESS, Bloomberg and Grant Samuel analysis

- Notes:
1. Market capitalisation has been calculated based on shares currently on issue.
 2. Newcrest shareholders’ share of the combined sharemarket value includes the special dividend (\$1.10 per Newcrest share).

Annexure 1. Independent Expert's Report

GRANT SAMUEL



The following table shows the relative contributions based on VWAPs compared to the relative values received under the terms of the Newmont Transaction by the shareholders of each company across different periods prior to announcement of the Revised Proposal:

NEWCREST – SHARE OF COMBINED SHAREMARKET VALUE

	3 FEBRUARY 2023		PERIOD TO 3 FEBRUARY 2023 (VWAP)				
	CLOSING PRICE	VWAP	ONE WEEK	ONE MONTH	THREE MONTHS	SIX MONTHS	TWELVE MONTHS
Share of combined sharemarket value contributed							
Newcrest							
Price (A\$)	22.45	22.48	22.58	22.60	20.88	19.16	21.61
Market capitalisation (A\$ millions)	20,075	20,102	20,192	20,210	18,672	17,133	19,324
A\$/US\$ exchange rate	0.6925	0.7001	0.7048	0.6985	0.6800	0.6731	0.6959
Market capitalisation (\$ millions) A	13,902	14,074	14,231	14,116	12,697	11,533	13,447
Newmont							
Price (\$)	49.85	50.20	52.23	52.61	48.33	45.20	55.48
Market capitalisation (\$ millions) B	39,620	39,898	41,511	41,813	38,412	35,924	44,094
Combined sharemarket value (\$ millions) C=A+B	53,522	53,971	55,742	55,929	51,109	47,457	57,541
Newcrest % contribution A/C	26.0%	26.1%	25.5%	25.2%	24.8%	24.3%	23.4%
Newmont % contribution B/C	74.0%	73.9%	74.5%	74.8%	75.2%	75.7%	76.6%
Combined sharemarket value after cash component (\$ millions) D = C – E¹	52,538	52,988	54,759	54,945	50,125	46,473	56,558
Share of combined sharemarket value received							
Newcrest (\$ millions) F = (D x 31%) + E ¹	17,290	17,429	17,979	18,037	16,541	15,408	18,537
Newmont (\$ millions) G = (D x 69%) ²	36,232	36,542	37,763	37,892	34,568	32,049	39,004
Newcrest % received F/C	32.3%	32.3%	32.3%	32.2%	32.4%	32.5%	32.2%
Newmont % received G/C	67.7%	67.7%	67.7%	67.8%	67.6%	67.5%	67.8%

Sources: IRESS, Bloomberg and Grant Samuel analysis

- Notes:
- Where E = the special dividend (\$984 million), calculated as 894.2 million Newcrest shares x \$1.10 per share.
 - On implementation of the Newmont Transaction existing Newcrest shareholders will own 31% of the Merged Group and existing Newmont shareholders will own 69%.

The analysis demonstrates that, based on sharemarket prices over an extended period prior to the announcement of the Revised Proposal, Newcrest shareholders are consistently contributing a considerably lower share of the combined sharemarket value (23.4-26.1%) than they are receiving (32.2-32.5%, taking into account the special dividend) in the Merged Group. This relationship indicates that Newcrest shareholders are receiving a “premium” of approximately 30% (i.e. ~32%/~25%).

Analysis of relative contributions of value based on sharemarket prices need to be treated with some caution. Sharemarket views on value can shift significantly in short periods of time. The sharemarket prices of Newcrest and Newmont exhibited some volatility over the 12 months prior to announcement of the Revised Proposal. Both companies have also been impacted by a number of specific events including results announcements. Despite this, the relationship has remained remarkably stable over a sustained period which supports a clear premium.

More than six months have elapsed since announcement of the Revised Proposal. Both companies have announced results (Newcrest for FY23 and Newmont for 4Q22 (and CY22), 1Q23 and 2Q23). It is not possible to reliably assess where the relative contributions of the two companies would now be if the Newmont Transaction had not been agreed.

The Newmont share price has been volatile since announcement of the Revised Proposal. It has traded as high as \$52.76 and as low as \$37.84. While Newmont’s 2Q23 results appear to have been responsible for a significant element of this decline, the share price also appears to have been influenced by initial reaction

GRANT SAMUEL



to the Revised Proposal, the Further Revised Proposal and the Newmont Transaction (i.e part of the fall could be because of the terms agreed with Newcrest). Newmont's Latest Share Price of \$39.32 is 23% lower than the share price immediately prior to announcement of the Further Revised Proposal.

The fall in the Newmont share price has been greater than the fall in the listed gold sector⁸⁵ over the same period although that has fallen by around 18% (i.e. Newmont has underperformed the market by approximately 5%). Even allowing for this underperformance, the percentage of the Merged Group being received by Newcrest shareholders would still represent a substantial premium to their contribution to the Merged Group.

Grant Samuel believes that the sharemarket analysis is sufficiently robust to be a valuable benchmark in assessing the relative contribution of value by Newcrest shareholders.

OTHER PARAMETERS

Grant Samuel has also considered the contributions of Newcrest and Newmont to the Merged Group based on other financial parameters, although these provide less reliable metrics on which to judge the terms of the Newmont Transaction:

RELATIVE CONTRIBUTIONS – OTHER FINANCIAL PARAMETERS

	MOZ OR \$ MILLIONS		CONTRIBUTION TO THE MERGED GROUP ⁸⁸	
	NEWCREST	NEWMONT	NEWCREST	NEWMONT
Newmont Transaction terms			31.0%	69.0%
Reserves, Resources and Production	Moz	Moz		
Attributable gold resources (30 June 2023)	131.5 ⁸⁹	205.1 ⁹⁰	39.1%	60.9%
Attributable gold reserves (30 June 2023)	58.0	93.6 ⁹⁰	38.2%	61.8%
CY22 pro forma attributable gold production	2.2	6.0	26.9%	73.1%
1HY23 pro forma attributable gold production	1.0	2.5	29.3%	70.7%
Sales and earnings⁹¹	\$ millions	\$ millions		
CY22 pro forma sales	4,503	11,915	27.4%	72.6%
CY22 pro forma EBITDA	1,974	4,550	30.3%	69.7%
1HY23 pro forma sales	2,356	5,362	30.5%	69.5%
1HY23 pro forma EBITDA	1,500	1,900	35.4%	64.6%
Assets⁹¹	\$ millions	\$ millions		
Pro forma total assets (30 June 2023)	18,304	38,133	32.4%	67.6%
Pro forma net assets (30 June 2023)	12,116	19,225	38.7%	61.3%

Source: Newcrest, Newmont, Scheme Booklet and Grant Samuel analysis

Based on attributable gold resources and reserves at 30 June 2023, Newcrest is contributing disproportionately to the Merged Group. These larger contributions (relative to the share of the Merged Group received by Newcrest shareholders) reflect the relatively longer life of many of Newcrest's assets (its two largest operational assets, Cadia and Lihir, have estimated reserve lives of 30+ years and 20+ years, respectively and Wafi-Golpu also has an estimated reserves life of ~30 years. In contrast, while a number

⁸⁸ Contribution to the Merged Group excludes the special dividend being received by Newcrest shareholders as part of the Newmont Transaction.

⁸⁹ Includes an estimate of Newcrest's attributable gold reserves and resources in Fruta del Norte (from its 32% interest in Lundin) at 30 June 2023. Newcrest's attributable gold reserves and resources from Fruta del Norte have been estimated by Grant Samuel based on Lundin's reported gold reserves and resources at 31 December 2022 less Fruta del Norte's gold production for 1HY23.

⁹⁰ Newmont's attributable gold resources and reserves at 30 June 2023 have been estimated by Grant Samuel based on Newmont's reported gold resources and reserves at 31 December 2022 less Newmont's gold production for 1HY23.

⁹¹ Pro forma sales, earnings and assets for Newcrest have been reclassified and aligned for consistency with Newmont's reporting basis. Both Newcrest and Newmont pro forma sales, earnings and assets are before pro forma adjustments.

Annexure 1. Independent Expert's Report

GRANT SAMUEL



of Newmont's operating assets have reserve lives of more than 10 years, its two largest assets, Nevada Gold Mines (38.5% interest) and Boddington, have estimated reserve lives of 15+ years and 13+ years, respectively. The disproportionate contribution of resources and reserves by Newcrest shareholders needs to be considered in the context of the:

- timing of access to reserves and resources (e.g. for Wafi-Golpu, which is not yet an operating asset). Reserves and resources able to be exploited earlier are more valuable than those decades away; and
- greater uncertainty as to whether reserves (and more particularly, resources) will convert into production, which will depend on a range of factors including gold price and cost to extract and process etc. For example, Newcrest's Cadia has very substantial remnant resources outside the current mine plan (circa 25Moz).

The contributions to production, pro forma sales and pro forma EBITDA all favour Newcrest shareholders (albeit marginally) except 1HY23 pro forma EBITDA, where the relative contributions are distorted by production issues at several of Newmont's sites. Newmont expects to achieve CY23 guidance which would bring the relative contributions more in line with CY22. The relative contributions to CY22 pro forma EBITDA are closer to the proportions of the Merged Group that will be owned by each group of shareholders, reflecting Newcrest's higher margins (a pro forma CY22 (reclassified and aligned) EBITDA margin of 43.8% compared to Newmont's 38.2% margin).

Accounting estimates of net assets and total assets provide only a general indication of relative value contributions as accounting carrying values do not necessarily reflect economic values.

7.5 Reasonableness

While the Newmont Transaction does not meet the requirements for "fairness" under ASIC regulatory guidelines, the alternative framework for assessing the Newmont Transaction underpins its reasonableness. There are also other factors that Newcrest shareholders should consider in determining whether or not to vote for or against the Scheme (and the Newmont Transaction). These factors are set out in the following sections.

7.5.1 Premium for Control

Takeover transactions are commonly analysed by reference to the extent of the control premium being paid by the acquirer relative to the pre-bid share price. The Newcrest Transaction represents the following premiums to the price at which Newcrest shares traded in the period up to announcement of the Revised Proposal:

NEWCREST – PREMIUM OVER PRE-ANNOUNCEMENT PRICES

	NEWCREST PRICE/VWAP	A\$/US\$ EXCHANGE RATE	NEWCREST PRICE/VWAP	PREMIUMS	
				BASED ON ASSESSED VALUE RANGE OF CONSIDERATION	BASED ON NEWMONT'S LATEST SHARE PRICE
Closing price on 3 February 2023	A\$22.45	0.6925	\$15.55	10.0-20.3%	8.2%
1 week prior to 3 February 2023	A\$22.58	0.7048	\$15.92	7.4-17.5%	5.7%
1 month prior to 3 February 2023	A\$22.60	0.6985	\$15.79	8.3-18.4%	6.6%
3 months prior to 3 February 2023	A\$20.88	0.6800	\$14.20	20.4-31.7%	18.5%
6 months prior to 3 February 2023	A\$19.16	0.6731	\$12.90	32.6-45.0%	30.5%
12 months prior to 3 February 2023	A\$21.61	0.6977	\$15.07	14.9-25.7%	13.1%

The premium based on daily prices of both Newcrest and Newmont shares over the period since 1 September 2022 can be depicted graphically:



GRANT SAMUEL



NEWCREST – SHARE PRICE VS VALUE OF CONSIDERATION

1 SEPTEMBER 2022 TO 1 SEPTEMBER 2023

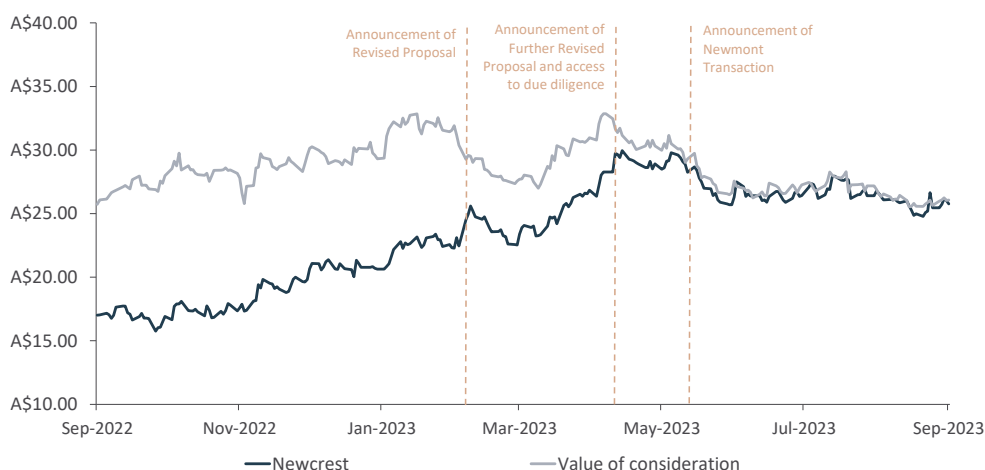

Source: IRESS, Bloomberg and Grant Samuel analysis

The Newmont Transaction represents premiums for control of less than 20% (and on some bases less than 10%) over periods of up to a month prior to announcement of the Revised Proposal. There are materially higher premiums (in the range 23-48%) over longer periods but recent Newmont share prices are a more appropriate base from which to measure the premium implied by the Newmont Transaction as the three and six month VWAPs simply reflect lower share prices (and lower gold prices) prevailing earlier in those periods. The Newcrest share price had been trading steadily upwards since October 2022 as gold prices increased.

The level of premiums observed in takeovers varies depending on the circumstances of the target and other factors (such as the potential for competing offers) but tend to fall in the range 20-35%. The premiums for control implied by the Newmont Transaction fall below this range, indicating that, based on current Newmont share prices, Newcrest shareholders are not receiving a full premium for control.

However, it is important to recognise that premiums for control are an outcome not a determinant of value and they vary widely depending on individual circumstances. In the case of the Newmont Transaction:

- the implied premiums at the time of announcement of the Revised Proposal, Further Revised Proposal and Newmont Transaction were considerably higher (reflecting the higher Newmont share price at the time):

NEWCREST – IMPLIED PREMIUMS ON ANNOUNCEMENT DATES

PERIOD	PREMIUMS		
	REVISED PROPOSAL (3 FEBRUARY 2023)	FURTHER REVISED PROPOSAL (10 APRIL 2023)	NEWMONT TRANSACTION (12 MAY 2023)
Newmont share price	\$49.85	\$51.09	\$45.94
Closing price on 3 February 2023	21.8%	38.5%	25.3%
1 week prior to 3 February 2023	19.0%	35.3%	22.4%
1 month prior to 3 February 2023	20.0%	36.4%	23.4%

In this regard it should be noted that:

- the Revised Proposal, which implied premiums that are similar to the high end of the assessed value of the consideration, was rejected by the Newcrest Board;

Annexure 1. Independent Expert's Report

GRANT SAMUEL



- the Further Revised Proposal and the Newmont Transaction premiums are broadly consistent with those typically associated with takeovers in Australia; and
- Newmont's Latest Share Price, which is slightly below the assessed value range of the consideration, implies lower premiums than the Revised Proposal;
- movements in the gold price since the announcement of the Revised Proposal mean that premium estimates based on historical prices can be misleading; and
- the listed gold sector has fallen since 3 February 2023 (by 7%). If it is assumed the Newcrest share price would have moved in line with this market movement⁸⁵ the "notional" undisturbed Newcrest share price on 3 February 2023 would be A\$20.98 (\$13.54) and the effective premium based on the current market value of the consideration would be in the order of 24%.

While Newcrest shareholders are not receiving a full premium for control, they are receiving some premium. In the absence of an alternative proposal (which is considered unlikely, see Section 7.5.2), Newcrest shareholders would only be able to realise value for their Newcrest shares on-market at prices which, in the short term, are likely to be below the assessed value of the consideration. In the absence of the Newmont Transaction (or an alternative control transaction or speculation as to one) it may be some time before Newcrest shares trade at levels equivalent to the assessed value of the consideration under the Newmont Transaction.

7.5.2 Alternatives

Status Quo

Newcrest is one of the largest gold producers in the world. It has a portfolio of high quality and low cost mineral assets that have one of the longest implied reserve lives compared to its peers, particularly at Cadia and Lihir. Its global organic growth portfolio provides additional opportunities to sustain (and grow) its mining operations as well as increase its diversification into "future-facing" commodities such as copper. The company is adequately capitalised with sufficient financial liquidity to support its near-term growth investments. In any event, Newcrest is an investment grade borrower and should have adequate access to capital markets to support its funding requirements.

While its operating performance has been challenged in recent years, the company has dedicated more than \$3 billion in capital to reinvest in its mineral assets and has also acquired interests in other assets (e.g. Red Chris, Brucejack and Lundin Gold) to diversify its operations. Fully carrying out its investment strategy will inevitably require significant amounts of capital but, if successful, should lead to an extended period of "harvesting" of cash flows in due course and a potential value uplift over time for Newcrest shareholders.

On the other hand:

- the value of Newcrest shares will continue to be heavily influenced by the operating performance of Cadia and Lihir (at least in the near term). Until other projects are developed (e.g. Red Chris block cave and Wafi-Golpu), there will continue to be a very high level of concentration in these two assets. In this context, Cadia faces some indeterminable risks relating to dust issues impacting on the local community. In a worst case, there could be serious consequences for ongoing production;
- successfully executing the organic growth initiatives involves project development risk. While some of these projects are already underway (e.g. Cadia expansion), a number remain subject to a final investment decision (e.g. Red Chris block cave expansion and Havieron development). Moreover, Wafi-Golpu will inevitably face its own set of regulatory and jurisdictional risks (although this is less of an issue as it only represents ~3% of Newcrest's value);
- the Newcrest senior management team has undergone significant transition over the past year following the retirement of the former CEO in December 2022. Newcrest currently has an interim

G R A N T S A M U E L



CEO, CFO and COO. If the Newmont Transaction is not implemented, Newcrest would need to make permanent appointments for those roles. The Newmont Transaction resolves the question of future management and leadership that would otherwise need to be addressed by a standalone Newcrest; and

- a decision to reject the Newmont Transaction and proceed on a standalone basis would not be without risk. It is likely that the Newcrest share price would fall, at least in the short term (see Section 7.5.3). At the same time, it would preserve the ability of Newcrest shareholders to realise a change of control premium in the future once its portfolio of organic growth opportunities are more fully developed. However:
 - there is no certainty that any or all of these growth opportunities would be successfully developed and result in a value uplift;
 - there are relatively few potential acquirers that have the scale and financial capacity to acquire Newcrest (see below); and
 - there is no guarantee that there would be a change of control event in the foreseeable future (or within a shareholder's investment horizon).

Shareholders who would prefer not to be exposed to these uncertainties would be justified in preferring to vote in favour of the Newmont Transaction.

Other Acquirers

In weighing up any offer, shareholders need to have regard to the alternatives that are realistically available to them. It is conceivable that a third party could make a higher offer for Newcrest:

- the Newmont Transaction has highlighted Newcrest's attractive portfolio of long-life and low cost gold and copper mineral assets with an established organic growth pipeline, particularly against the sector backdrop of what some market commentators have referred to as a brewing "reserves crisis";
- there are no structural impediments to an alternative acquirer:
 - while there are the usual exclusivity provisions in the scheme implementation deed, there is a fiduciary carve out and Newcrest can respond to unsolicited proposals from other parties (subject to a disclosure obligation);
 - the break fee of \$174 million payable by Newcrest (under certain circumstances) is not material having regard to the standalone value of Newcrest;
 - there are potential alternative acquirers of Newcrest, none of which would be likely to be blocked from acquiring Newcrest on competition grounds; and
 - there is only one shareholder with a relevant interest in just under 10% of Newcrest's shares (Blackrock) but it is considered a passive investment company; and
- while the extent of the premium at the time of announcement of the Newmont Transaction was significant and may have been a deterrent, the subsequent decline in the Newmont share price (in excess of 20% since announcement of the Revised Proposal) has reduced the market value of the consideration and opened up an opportunity for an alternative acquirer.

On the other hand:

- in addition to the corporate head office savings there are substantial synergies that are arguably unique to Newmont given the overlap of existing regional teams and mineral assets in Australia and Canada (including in the Golden Triangle province). Newmont has estimated aggregate synergies of \$500 million per annum (to be achieved over time). Arguably, no sector peers could replicate the

Annexure 1. Independent Expert's Report

GRANT SAMUEL



same level value creation opportunities from a merger with Newcrest. Newcrest shareholders will have a 31% share of these synergies;

- there are relatively few potential acquirers that have the scale and financial capacity to acquire Newcrest. Private equity and other financial buyers are highly unlikely given Newcrest's commodity exposure (and to some extent its scale). Larger diversified miners (e.g. Glencore, BHP, Rio Tinto and Teck) may also have the scale and financial capacity to acquire Newcrest and, in fact, may have exposure to gold through their copper-gold mining operations (and, in BHP's case, was previously a part-owner of the antecedents of Newcrest). However:
 - large diversified miners are likely to view gold as a "niche" sector (out of which some have previously made decisions to exit). They are more likely to be focused on industrial scale minerals (such as iron ore and alumina) and/or "future facing metals" such as copper and nickel (given their role in the energy transition); and
 - investors are more likely to want exposure to "pure gold" assets rather than have their exposure buried in the company's larger portfolio.

While the possibility of some interest cannot be completely ruled out, it is important to note that the majority of buyers of established gold producers in the past decade were also primarily gold producers. Apart from Newmont, Barrick Gold and Agnico Eagle are the only other industry participants that have a market capitalisation greater than Newcrest and have the scale and clear financial capacity to do so. However:

- Barrick Gold has ruled out a potential counterbid for Newcrest. During a mining conference in early 2023, the CEO of Barrick Gold is reported to have stated that such a deal "doesn't make sense right now"; and
- Agnico Eagle has recently completed two major transactions (i.e. Yamana Gold and Kirkland Lake) and is widely expected to have its "hands full" integrating these assets into its portfolio.

At the same time, both companies are able to change their minds.

- in any event, in view of the size of Newcrest, any alternative acquisition proposal by an industry participant would almost certainly involve a substantial scrip component. Many of the industry consolidation transactions over the past decade have been undertaken as mergers of equals (with no or limited premiums). Any offer with a substantial scrip component will face challenges to paying a full control premium because of the inevitable dilutionary impact and will also be subject to the same share price volatility issues as the Newmont Transaction; and
- other than Blackrock, there are three other substantial shareholders (i.e. Allan Gray, State Street Corporation and The Vanguard Group) that each hold an approximate 5-6% interest in Newcrest. While a portfolio manager at Allan Gray was reported to have stated that the Revised Proposal (which was rejected by the Newcrest Board) was "a bit light" and the Newmont Transaction currently represents an 11% discount to the Revised Proposal, there have been no further public statements by Allan Gray (or any other shareholder) in relation to the Further Revised Proposal that indicate opposition to the transaction.

There has been ample time since announcement of the Revised Proposal on 6 February 2023 for a third party to come forward with a competing change of control proposal and no such proposal has been received by Newcrest despite the "window of opportunity" created by the fall in the Newmont share price. If one does not arise, it can be viewed supporting the proposition that there is no higher value for Newcrest than that being paid by Newmont.

The meeting at which Newcrest shareholders will vote on the Scheme is scheduled for 13 October 2023. If no competing proposal eventuates prior to the shareholder meeting to vote on the Scheme, it would be imprudent for shareholders to vote against the Scheme in anticipation of a higher offer from Newmont or a

GRANT SAMUEL



third party. In particular, Newmont has stated that the Scheme consideration it has offered represents the “best and final” price it is willing to offer so it is not able to increase its offer in the absence of a competing proposal.

Other Structural Alternatives

Some analysts have questioned whether a demerger or sell-down of specific assets (e.g. splitting Newcrest’s gold-only mineral assets from its copper-gold mineral assets) would produce more value for shareholders. However, such a transaction would inevitably require a more extensive execution process. A demerger would be substantially more complex (compared to a scrip offer in hand). A viable offer for individual Newcrest assets may or may not eventuate. In any event, no such offer has been received by Newcrest.

7.5.3 Share Trading in the Absence of any Offer

In the absence of the Newmont Transaction or a similar transaction, Newcrest shareholders could only realise their investment by selling on market at a price which does not include any premium for control and would incur transaction costs (e.g. brokerage).

It is likely that, under current market conditions (and current gold and copper prices) and in the absence of the Newmont Transaction or a similar transaction (or speculation as to one), Newcrest shares would trade at prices below the assessed value of the consideration under the Newmont Transaction (of \$17.10-18.70), at least in the short term. Prior to announcement of the Revised Proposal, Newcrest shares were trading at around A\$22 (equivalent to ~\$15). Since then, the listed gold sector⁸⁵ has fallen by 7%. It would not be unreasonable to form the view that the Newcrest share price would also be lower now than it was prior to announcement of the Revised Proposal and in the absence of any upward movement in the gold price, it may take some time for Newcrest’s share price to increase to the levels implied by the Newmont Transaction.

7.5.4 Other Advantages and Benefits

Capital Gains Tax Rollover Relief

Scrip for scrip capital gains tax rollover relief should be available to most Australian resident shareholders in relation to the Scheme consideration. This will defer the taxation of any capital gain until the Newmont securities received as Scheme consideration are disposed of (see Section 7.5.6 for further discussion).

Special Dividend

Under the Newmont Transaction, a special dividend of \$1.10 per share is expected to be paid by Newcrest on or around implementation of the Scheme. The special dividend is expected to be franked³. In Grant Samuel’s opinion, it is not appropriate for the assessment of the Newmont Transaction to either:

- factor into the value of Newcrest shares the value of accumulated franking credits; or
- include in the value of the consideration the value of the credits attached to the special dividend.

The reasons are manifold but not the least of these is that the franking credits do not have value to a company per se but only have value to the shareholders of a company (when attached to dividends) and the value of those credits to each shareholder varies depending on their individual circumstances.

Nevertheless, it needs to be recognised that, where as part of a takeover offer or scheme, a franked dividend is paid, some shareholders may realise additional value from the franking credits (i.e. they are better off in after tax terms than they would have been had the same amount been paid as part of the acquisition price and been received as a capital gain). The following table sets out illustrative calculations for a variety of shareholder types:

Annexure 1. Independent Expert's Report

GRANT SAMUEL



SPECIAL DIVIDEND – FRANKING CREDIT BENEFIT ANALYSIS⁹²

	FOREIGN RESIDENT SHARE-HOLDER ⁹³	AUSTRALIAN RESIDENT INDIVIDUAL ⁹⁴			AUSTRALIAN SUPER FUND	AUSTRALIAN CORPORATE
		45% MARGINAL RATE	30% MARGINAL RATE	0% MARGINAL RATE		
\$1.10 received as a fully franked dividend						
Dividend	1.10	1.10	1.10	1.10	1.10	1.10
Franking credit	-	0.47	0.47	0.47	0.47	0.47
Gross taxable income	1.10	1.57	1.57	1.57	1.57	1.57
Tax payable	t	(0.74)	(0.50)	-	(0.24)	(0.47)
Tax credit	-	0.47	0.47	0.47	0.47	0.47
Net tax payable	-	(0.27)	(0.03)	0.47	0.24	-
Net after tax income	1.10 - t	0.83	1.07	1.57	1.34	1.10
\$1.10 received as a capital gain						
Gain	1.10	1.10	1.10	1.10	1.10	1.10
Tax payable	t	(0.26)	(0.18)	-	(0.11)	(0.33)
Net after tax income	1.10 - t	0.84	0.92	1.10	0.99	0.77
Net benefit of dividend	-	(0.01)	0.14	0.47	0.35	0.33

Primarily, the benefits from franked dividends (relative to capital gains) flow to Australian resident shareholders on lower tax rates (e.g. superannuation funds). There is no benefit to foreign resident shareholders (who comprise a significant proportion of Newcrest shareholders), while Australian resident shareholders on the top marginal tax rate would have been marginally better off receiving the amount as a capital gain.

No Transaction Costs

If the Newmont Transaction is implemented, Newcrest shareholders will not incur any transaction costs (i.e. brokerage) to acquire Newmont securities. Moreover, as the exchange ratio under the Newmont Transaction reflects a premium, their interest in Newmont will be greater than if they had realised their Newcrest shares on market and used the sale proceeds (net of transaction costs) to acquire Newmont shares on market (also net of transaction costs).

Retention of Newmont Securities

The decision to hold Newmont securities is independent of a decision to vote in favour of the Newmont Transaction. However, Newcrest shareholders who retain the Newmont securities received as Scheme consideration will:

- retain an exposure to the long-life tier 1 gold and copper assets and high quality development pipeline of the Newcrest business, albeit on a diluted basis relative to their current position. Newcrest shareholders will collectively own approximately 31% of Newmont;
- gain an exposure to Newmont's portfolio of gold and copper assets in predominantly low-risk jurisdictions (including additional tier 1 assets in Australia, the United States, Mexico, Ghana and the Dominican Republic as well as assets across Canada, Peru, Suriname, Argentina, Chile and Ghana). The Merged Group will be the leading gold mining company globally with 10 tier 1 assets and a

⁹² For simplicity, this analysis has been prepared in US\$.

⁹³ Assumes the same tax rate applies to Australian dividend income and an Australian capital gain for a foreign resident shareholder. As tax rates will vary for each foreign resident shareholder, the tax payable by a foreign resident shareholder has been shown as "t" for the purposes of this analysis. Foreign resident CGT withholding tax of 12.5% can apply in certain circumstances although Newcrest's expectation is that it should not apply in the current circumstances.

⁹⁴ Assumes the shares have been held for more than 12 months and that the Medicare levy is 2%.

GRANT SAMUEL



portfolio of assets at different stages of the production and development cycle. This variety of exposures offers risk reduction benefits through diversification as well as increased flexibility in project sequencing and growth optionality;

- have an exposure to the only gold company included in the S&P 500;
- have the potential to benefit from any synergy benefits extracted by Newmont from its acquisition of Newcrest (including through portfolio optimisation);
- be entitled to Newmont dividends (paid quarterly) on a pari passu basis with Newmont shareholders (i.e. they will be entitled to all dividends paid by Newmont after the date of issue of the shares under the Newmont Transaction). The first dividend payment received by Newcrest shareholders is expected to be for 4Q23 (i.e. the quarter ended 31 December 2023);
- hold an investment in a company with a similar degree of leverage. Based on results to 30 June 2023, Newcrest had a net borrowings to EBITDA ratio of 0.7 times (or 0.6 times on a reclassified and aligned basis). The Merged Group had a pro forma net borrowings to adjusted EBITDA ratio of 0.8 times before synergies and 0.7 times after synergies. Newmont also has a lower target net borrowings to adjusted EBITDA ratio of less than 1.0 times compared to Newcrest's target of less than 2.0 times. Newmont's higher credit rating (BBB+/Baa1 compared to Newcrest's BBB/Baa2) should (all other things being equal) lead to a lower cost of debt, although as both credit ratings are investment grade, the overall impact may not be material, especially given the relatively low levels of debt (by way of example, Newmont's weighted average cost of debt in CY22 was 4.1% compared to Newcrest's FY23 cost of debt for corporate bonds of approximately 4.3%). The Merged Group will also have access to Newmont's total liquidity of \$6.2 billion (compared to Newcrest's total liquidity of \$2.3 billion);
- based on the disclosures in the Scheme Booklet, Newcrest shareholders would experience an increase in post synergies EPS (from continuing operations before adjustments) and dividends per share as shown below:

PRO FORMA IMPACT PER EQUIVALENT NEWCREST SHARE

	CY22 NEWCREST STAND- ALONE ⁹⁵	CY22 MERGED GROUP PRO FORMA	VALUE OF NEWMONT TRANSACTION PER SHARE			
			EQUIVALENT NEWCREST SHARE ⁹⁶		CHANGE	
			\$40.00	\$44.00	\$	%
EPS ⁹⁷ (pre synergies)	\$0.94	\$1.98	\$0.85	\$0.84	\$(0.09)-(0.10)	(10.0)-(10.5)%
EPS ⁹⁷ (post synergies)	\$0.94	\$2.27	\$0.97	\$0.96	\$0.02-0.03	2.6-3.2%
DPS	\$0.55 ⁹⁸	\$2.05	\$0.88	\$0.87	\$0.32-0.33	58.4-59.3%
DPS (grossed up)	\$0.79	\$2.05	\$0.88	\$0.87	\$0.08-0.09	10.3-10.9%

Scheme Booklet and Grant Samuel analysis

While the analysis indicates that the Newmont Transaction will be dilutive to Newcrest shareholders on the basis of pre synergies EPS from continuing operations before adjustments:

- it is marginally accretive after allowing for synergies (albeit these synergies are expected to be achieved over the 24 months post and not immediately following implementation); and

⁹⁵ Newcrest's standalone EPS is based on reclassified and aligned earnings for consistency with Newmont's reporting basis.

⁹⁶ Calculated at 0.4250-0.4275 Newmont securities for every Newcrest share, being the sum of the Scheme consideration of 0.40 Newmont securities plus the special dividend of \$1.10 cash reinvested in Newmont securities at a price of \$40.00-44.00.

⁹⁷ EPS from continuing operations before adjustments.

⁹⁸ Including the \$0.20 per share special dividend paid in February 2023.

GRANT SAMUEL



- this is arguably less relevant for shareholders given how the Newmont Board determines dividend payments (based on the gold price relative to a benchmark). Newmont pays a minimum dividend of \$1.00 per share based on a gold price of \$1,400/oz and a variable component based on incremental cash flow for increases in the gold price above a base assumption. In contrast, Newcrest targets a total annual dividend payout of 30-60% of free cash flow generated for the financial year, with the annual total dividends being at least \$0.15 per share on a full year basis. The analysis indicates a substantial uplift (more than 50%) in DPS for Newcrest shareholders (even after including the \$0.20 special dividend paid by Newcrest in March 2023), effectively due to an increase in the pro forma payout ratio from 37% to in excess of 100%. There is still a material uplift (~10%) in DPS after taking into account the franking credits that would accrue to Australian resident shareholders.

However:

- this pro forma impact per equivalent Newcrest share is based on the assumptions underlying Newmont's pro forma acquisition analysis and will also vary with movements in the Newmont share price. Therefore, the actual impact on EPS⁹⁷ and DPS (on an equivalent basis) for Newcrest shareholders may lie outside the ranges presented above; and
- Newmont's dividend framework is non-binding and may be modified. If the Newmont Transaction is implemented, the declaration and payment of future dividends will be determined by the Newmont Board having regard to circumstances at the time; and
- the Newmont CDIs will be listed on the ASX and Newmont expects that Newmont CDIs will be eligible (subject to meeting the necessary requirements) to be included in the S&P/ASX 100 and S&P/ASX 200 indices. The listing should enable most (but not all, see Section 7.5.5 below) investment institutions that have mandate restrictions to continue to hold Newmont CDIs and index inclusion will support liquidity in the trading on the ASX.

7.5.5 Disadvantages and Risks

Short Term Volatility in the Newmont Security Price

There may be short term volatility in the Newmont security price after the issue of new Newmont securities which will be of concern to Newcrest shareholders who decide to sell their Newmont securities in the short term:

- Newcrest shareholders who receive Newmont shares will be able to sell into a liquid market for NYSE-listed Newmont shares. However, to the extent that Newcrest shareholders that receive Newmont shares under the Newmont Transaction decide to sell those shares, the increase in selling volume may adversely impact the Newmont share price (and consequently, the Newmont CDI and the Newmont PDI price); and
- the liquidity of the market for ASX-listed Newmont CDIs (which will be quoted and trade in A\$) is more uncertain, although Newmont's expectation that the Newmont CDIs will be included in the S&P/ASX 100 and S&P/ASX 200 indices should support liquidity in trading on the ASX. However, there is no certainty that shareholders will be able to realise the Newmont securities received on implementation of the Newmont Transaction for an amount equivalent to the assessed value of the Scheme consideration due to:
 - the risks associated with any sharemarket investment (including fluctuations in the Newmont share price and the A\$/US\$ exchange rate); and
 - transaction costs.

The liquidity of the market for PNGX-listed PDIs could be similarly impacted.

GRANT SAMUEL



Forced Sale of Newmont Securities

Some Australian investment institutions may be forced to either sell their Newmont securities or substantially reduce their exposure because of restrictions in their mandates. This will include:

- funds that are not able to hold foreign shares or ASX foreign exempt listings or are limited to Australian incorporated companies will need to sell their holding; and
- even if Newmont CDIs are included in relevant S&P/ASX indices, some funds (e.g. passive index funds, funds limited to investing in shares included in the S&P/ASX 200 (or similar indices) and index hugging funds allowed only limited tracking error relative relevant S&P/ASX indices) are likely to need to reduce their total investment in Newmont because only the CDIs will be included in relevant S&P/ASX indices and at least some Newcrest shareholders are likely to convert their Newmont CDIs to Newmont shares after implementation of the Scheme.

Apart from the potential price issues when selling these shareholders will be disadvantaged to the extent that there is a loss of opportunity to invest in Newmont and earn the returns it may generate for shareholders.

Retention of Newmont Securities

The decision to hold Newmont securities is independent of a decision to vote in favour of the Newmont Transaction. However, Newcrest shareholders who retain the Newmont securities received as Scheme consideration will hold securities that have a different investment risk profile and certain features that may be unattractive:

- there will be an exposure to a larger number of individual assets across a range of geographies and a different mix of metals (more gold, less copper) and end markets. This diversity is useful for achieving risk diversification but it may not be attractive to Newcrest shareholders who, up to this point, have been investors in a more geographically focused company with a more material exposure to copper and arguably greater growth potential;
- the change from an Australian incorporated entity raises a number of governance issues for shareholders, particularly for Australian shareholders, including the following:
 - **shareholders will be subject to United States corporate law and regulation**

As an Australian incorporated entity with a primary listing on the ASX, Newcrest is governed, inter alia, by the Corporations Act and the ASX Listing Rules and is regulated by ASIC⁹⁹. In contrast, Newmont is subject to Delaware corporate law, NYSE listing rules and regulation by the SEC¹⁰⁰. The rights of shareholders and the governance of Newmont is also determined by its certificate of incorporation (as amended and restated) and the by-laws of the company (as amended and restated) which prescribe certain matters. Essentially, the certificate of incorporation sets out the rights of each class of share capital and other structural matters while the by-laws prescribe more day to day matters related to administration and operation of the company. There is a material difference between the rights of Newmont shareholders compared to the rights of Newcrest shareholders. Section 10 of the Scheme Booklet sets out a comprehensive explanation of these differences.

In some respects, it can be argued that the Delaware/NYSE regime and the Newmont certificate of incorporation/by-laws afford lesser protection for shareholders, especially minority shareholders. A major point of difference is the provisions relating to changes in control of the

⁹⁹ However, it should be noted that because Newcrest's ADRs are listed on the NYSE, it is already subject to some degree of regulation by the NYSE and the SEC.

¹⁰⁰ As Newmont intends to apply for a foreign exempt listing on the ASX it will be exempt from complying with most of the ASX Listing Rules.

Annexure 1. Independent Expert's Report

GRANT SAMUEL



company. In simple terms there is greater potential for control of Newmont to change hands without an offer being made to all shareholders. A cornerstone of Australian corporations law is the "20% rule" under which no party can increase its shareholding to 20% or more without making a formal takeover offer to all shareholders or obtaining the approval of the remaining shareholders (except under the "creep" provisions which allows 3% to be acquired every six months or with shareholder approval). In contrast, the situation with Newmont is quite different. It is not feasible or practical to attempt to consider the full array of potential consequences of this change. However, some of the more obvious ones are that:

- a third party could acquire a significant stake in Newmont, say more than 20%, without making an offer to all shareholders (by buying on market or through private treaty dealing). A holding above 20% is likely to confer a significant degree of influence; and
- there appears to be a greater ability for a bidder to secure a strong enough position to inhibit an open contest for control. In general, the Australian rules limit bidders to 20% pre bid stakes and attempt to ensure a fair auction develops if there is more than one bidder. The rules in the United States appear to allow a single party to lock up significant shareholdings in advance of making an offer, thereby restricting the possibility of a counter offer.

On the other hand:

- Delaware law can also be used to frustrate bidders who intend to combine their business with a target company by requiring a three year waiting period before they can do so without either board approval prior to the bidder obtaining a 15% or greater voting interest or a two-thirds vote of disinterested shareholders; and
- in any event, Newmont's size (the largest gold producer globally with a pro forma market capitalisation of around \$45 billion) is likely to be an impediment to any change of control transaction.

There are a number of other aspects of the regime that apply to Newmont that may be of concern to shareholders, including the following:

- Newmont has the ability to adopt a shareholder rights plan (colloquially referred to as a "poison pill") which could inhibit the ability of a bidder to acquire the company or a significant stake in the company. These plans can be implemented without shareholder approval. It is possible that such a plan could prevent shareholders from receiving what would otherwise be an attractive offer. At the same time:
 - such plans can also prevent parties from securing control on terms that could disadvantage shareholders (e.g. more than 80 United States companies adopted shareholder rights plans in 2020 in light of market and share price reactions to the COVID-19 pandemic); and
 - there are judicial constraints on directors acting other than in a bona fide manner;
- even where a formal offer is made, United States takeover law (Regulation 14(d) of the *Securities Exchange Act* of 1934) allows a bidder to make a partial offer which can be for a fixed aggregate number of shares as opposed to a fixed percentage of each shareholder's shareholding. Such a bid structure can mean that in some circumstances control can pass to a bidder with some shareholders selling (and receiving a control premium for) a high percentage of their holding while those not accepting will receive no premium;
- Delaware law allows the directors to issue shares which carry preferences as to voting, dividends, redemption or liquidation without shareholder approval. These issues could

G R A N T S A M U E L



effectively diminish the rights of existing shareholders. Newmont's certificate of incorporation creates a class of preferred stock that could be issued in the future without shareholder approval;

- shareholders are not required to approve any capital reduction or share buybacks by Newmont. Newcrest shareholder approval is required for any capital reduction and most share buybacks;
- Newmont shareholders are not able to call shareholders meetings in the same way in which Newcrest shareholders can under Australian corporate law (by shareholders representing more than 5% of the issued shares). Meetings may only be called by the board of directors, chair or CEO and chair of Newmont or by shareholders representing 25% of the issued shares. This would inhibit, for example, the ability to remove directors at the behest of shareholders;
- the system for election and removal of directors is different. The key differences arise from the "plurality" system of voting for contested elections (i.e. where the number of candidates for election as directors exceeds the number of directors to be appointed). Under this system, directors are elected in order of the number of votes received up to the number of directors to be elected. The main consequences of this arrangement are that:
 - a director can be elected with less than a majority of votes (which cannot occur in Australia); and
 - to vote out a director, there must be an alternative candidate that polls higher than the incumbent;
- under Delaware law, directors may determine the compensation of the board; and
- directors are exempt from personal liability for monetary damages for breach of fiduciary duty (to the extent permitted under Delaware law). Such exemptions are not permitted under Australian law.

On the other hand:

- important protection and rights for shareholders are carried over into Newmont's certificate of incorporation. For instance, any shareholder is able to nominate persons to the board or propose other resolutions (albeit only at the annual general meeting and only after giving the requisite advance notice); and
- there are some positive features of the Delaware/NYSE regime and the Newmont certificate of incorporation:
 - a number of events, such as amendment of the certificate of incorporation, sale of substantially all the assets, dissolution and most mergers, must be approved by a 50% majority of all shareholders entitled to vote at the meeting, not just those present and voting (and in the case of certain changes to the certificate of incorporation or mergers/sale of substantially all assets where the bidder holds more than a 10% interest, an 80% majority). While a 50% majority of all shareholders entitled to vote at the meeting is nominally a lower hurdle than Australia's 75% (of those shareholders present and voting), a 50% majority of all shareholders is in fact a higher hurdle if shareholders representing less than two thirds of total shares actually vote; and
 - appraisal rights (effectively a cash buyout at a judicially determined "fair value") are available in certain circumstances.

GRANT SAMUEL



Clearly there are some aspects of Delaware governance that are less favourable than the Australian regime and these could adversely affect Newcrest shareholders who retain Newmont securities in some circumstances at a future point in time. Shareholders may also be concerned about a corporate environment that has historically evidenced some manifest shortcomings.

However:

- the historical problems in the United States have more to do with personal dishonesty, financial reporting and auditor independence than with rules relating to takeovers, election of directors or shareholder voting. These shortcomings can be argued to apply equally to Australia which has had its share of corporate collapses and governance failings;
- despite its reputation as a “business friendly” environment, Delaware has a well-regarded corporate regulatory regime. It has an extensive jurisprudence track record and is responsible for much of the United States corporate law decisions. Approximately 50% of all listed companies in the United States (and more than 50% of the S&P 500) are incorporated in Delaware. Clearly, the vast majority of the world’s investment institutions regard Delaware as an acceptable place of incorporation; and
- these issues are unlikely to be of concern to Newcrest’s United States-based shareholders (which represent around 30% of Newcrest’s issued shares and include substantial shareholders Blackrock, State Street Corporation and The Vanguard Group) who are presumably comfortable with the Delaware/NYSE regime.

In the final analysis, exposure to a different corporate governance and regulatory structure is the cost of being directly present in the world’s largest capital market. The United States is clearly regarded as a satisfactory jurisdiction by most of the world’s leading investors. Ultimately, effective corporate governance and regulation are more dependent on personal behaviour than the rules themselves;

- ***general meetings, if not held online, will be held in the United States***

Although it has the ability to hold its annual general meeting in any place and in any manner determined by the Board, Newcrest has a long history of holding its annual general meeting in Melbourne, Victoria (other than during the height of the COVID-19 pandemic in 2020 and 2021 when the annual general meeting was held online only). Newmont is also able to hold its annual general meeting anywhere but:

- up until 2020, annual general meetings were held in person at various locations in the United States (Denver, Colorado from 2002 to 2006 and from 2018 to 2020, Wilmington, Delaware from 2007 to 2016 and New York, New York in 2017); and
- since 2021 (including the 2023 annual general meeting held in April 2023), annual general meetings have been held online only.

Newmont has not publicly stated whether it intends to continue to hold its annual general meetings online or revert back to in person meetings. In any event:

- while the online format enables participation by all shareholders, regardless of their geographical location, the time of the meetings may not be convenient for Australian-based shareholders (online meetings over the last three years have been held at either 7.30am/8.00am or 2.00pm, Mountain Daylight Time, which is 11.30pm/midnight or 6.00am Australian Eastern Standard Time); and
- if Newmont reverts to in person annual general meetings, it will be impractical for most Australian based shareholders to attend these meetings, although Australian institutions with global affiliates may be able to attend.

G R A N T S A M U E L



To this extent, Australian shareholders are being disenfranchised. However:

- the perceived importance of attending the annual general meeting will vary from shareholder to shareholder. Many may not regard it as particularly important; and
 - shareholders (even if holding shares through CDIs or PDIs), will still be able to vote on resolutions put to shareholders; and
 - ***there are certain differences between Newmont shares and Newmont CDIs***
- Newcrest shareholders who hold their Newcrest shares on the Australian Register will receive ASX-listed Newmont CDIs. Newmont CDIs are, for practical purposes, economically equivalent to Newmont shares. However, there are certain differences:

- holders of CDIs are unable to attend meetings of Newmont shareholders and are unable to vote their shares directly at general meetings. However, they do have the following options:
 - instruct the nominee and legal owner of the units, CHESSE Depository Nominees Pty Limited, to vote the units in the desired manner by proxy;
 - instruct CHESSE Depository Nominees Pty Ltd to appoint the CDI holder as proxy, enabling the CDI holder to vote the Newmont shares at the meeting; or
 - convert their Newmont CDIs into a holding of Newmont shares and vote these at the meeting, which may incur a fee and would require conversion back to CDIs to subsequently sell the shares on the ASX.
- Clearly, CDI holders will be able to exercise their votes but the process is unusual and cumbersome; and
- the CDIs are tradeable only on the ASX and can only be traded on the NYSE and the TSX by converting Newmont CDIs into a holding of Newmont shares. Accordingly, the trading pool on the ASX will be limited to the CDIs, which could impact the liquidity and the trading price of the CDIs relative to the price of Newmont shares. However, the ability to convert CDIs into shares should mean that arbitrage will limit the extent of any discount.

Holders of PDIs will face similar issues (see Section 11.6 of the Scheme Booklet for details).

These matters may be of concern to Newcrest shareholders, but Newcrest shareholders who are uncomfortable with exposure to Newmont are able to sell the Newmont securities they receive as Scheme consideration. While there could be some downward pressure on the relevant Newmont security price if large numbers of Newcrest shareholders decide to sell over a short period of time, and this pressure could be exacerbated if the trading pool is limited primarily to the CDIs listed on the ASX and/or the PDIs listed on the PNGX (on the basis that those shareholders who hold their Newcrest shares on the Canadian Register are more likely to reside overseas and will presumably more comfortable retaining the Newmont shares received as Scheme consideration), Newcrest shareholders will represent, in aggregate, only approximately 31% of the issued capital of Newmont;

- Newmont reports its results using US GAAP. This change is expected to result in lower reported earnings for Newcrest's contribution to the Merged Group than Newcrest would have reported under IFRS Accounting Standards.

However, in Grant Samuel's opinion this is unlikely to have any material adverse impact on shareholders. The transition to US GAAP has no direct economic consequences for shareholders. It is merely a change in accounting presentation, has no cashflow impact and the differences between US GAAP and IFRS Accounting Standards are well understood;

Annexure 1. Independent Expert's Report

GRANT SAMUEL



- as Newmont is not an Australian incorporated company, dividends will not be franked for Australian income tax purposes (see Section 7.5.6). In addition, there will be a withholding tax at the rate of 15% on dividends paid to Australian residents and on dividends paid to most other non-United States resident shareholders. However:
 - Newcrest pays out a relatively low dividend compared to Newmont:

NEWCREST AND NEWMONT – DIVIDEND PROFILE

	FY19/CY19	FY20/CY20	FY21/CY21	FY22/CY22	FY23/1HY23
Newcrest					
Dividend per share	0.220	0.250	0.550	0.275	0.350 ¹⁰¹
Grossed up dividend per share	0.314	0.357	0.786	0.393	0.500
Yield on share price (period end)	0.98%	1.15%	2.90%	1.91%	1.99%
Grossed up yield on share price (period end)	1.40%	1.64%	4.15%	2.72%	2.84%
Newmont					
Dividend per share	1.44	1.45	2.20	2.05	1.60 ¹⁰²
Yield on share price (period end)	3.31%	2.42%	3.55%	4.34%	3.75%

Source: Newcrest, Newmont and Grant Samuel analysis

Since February 2021, Newcrest has targeted a total annual dividend payout of 30-60% of free cash flow generated each year (up from 10-30% previously), with the annual total dividends being at least \$0.15 per share. In contrast, since late 2020, Newmont has applied a non-binding structured dividend framework under which shareholders receive a stable base dividend of \$1.00 per share at the gold reserve price assumption of \$1,400/oz and a variable component based on incremental free cash flow for every \$100/oz increase above the base gold price assumption, calibrated in increments of \$300/oz. The loss of franking is more than offset by the substantially higher dividend payout;

- there is no detriment to non-Australian shareholders as they receive no benefit from dividend franking (except for the elimination of withholding tax); and
- for Australian residents and residents in most other non-United States jurisdictions, the withholding tax may be creditable against the shareholder's foreign income. Accordingly, there should be no net cost (other than a timing cost) for shareholders from the withholding tax impost (although there is always the possibility of an adverse outcome depending on particular individual circumstances); and
- as with any acquisition, there will be risks attached to the integration of the acquired business into the operations of the acquirer. Key risk areas include management (retention, working relationships), information systems and technology, customer relationships and the ability to realise synergies. Any such issues can result in adverse impacts on operating earnings or incur additional costs. In addition, while Newmont undertook due diligence, it may not have identified specific issues within Newcrest that could lead to unanticipated costs or liabilities. However, to the extent these would have arisen in any event, Newcrest shareholders are better off (through having a diluted exposure to them as shareholders in Newmont).

In Grant Samuel's opinion, while these disadvantages and risks are not inconsequential, most have mitigating factors and they are not sufficiently material to change the conclusion that the Newmont Transaction is in the best interests of Newcrest shareholders in the absence of a superior proposal.

¹⁰¹ Excluding the \$0.20 per share special dividend paid in February 2023.

¹⁰² Newmont's CY23 dividend yield is based on the annualised 1HY23 dividend.

G R A N T S A M U E L



7.5.6 Taxation Issues

The analysis set out below outlines the major tax consequences of the Newmont Transaction and should be viewed as indicative only. It does not purport to represent formal tax advice regarding the tax consequences of the Newmont Transaction for shareholders. Further details on the taxation consequences of the Newmont Transaction for Australian, United States and United Kingdom resident shareholders are set out in Section 9 of the Scheme Booklet. In any event, the taxation consequences for shareholders will depend upon their own individual circumstances. If in any doubt, shareholders should consult their own professional adviser.

Capital Gains Tax

As Newcrest did not list on the ASX until 1987 (initially as Newmont Australia), all Newcrest shareholders will have acquired their Newcrest shares after 19 September 1985, and, if the Newmont Transaction is implemented, will be treated as having disposed of their Newcrest shares for tax purposes. Where the shares are held on capital account, a taxable capital gain or loss would ordinarily arise on disposal depending on the cost base for the Newcrest shares, the length of time held and whether the shareholder is an Australian resident for tax purposes.

However, scrip for scrip capital gains tax rollover relief should be available to most Australian resident shareholders in relation to the Scheme consideration. This will defer the taxation of any capital gain until the Newmont securities received as Scheme consideration are disposed of. If a capital loss would have been realised, rollover relief will not be available and a capital loss will crystallise.

Non-Australian resident Newcrest shareholders should not be subject to Australian capital gains tax on any gain derived from the disposal of their Newcrest shares¹⁰³ but may have capital gains tax consequences in their home jurisdiction.

Treatment of Special Dividend

The special dividend received from Newcrest, along with any attaching franking credits, should be included in the assessable income of a shareholder in the income year in which the special dividend is paid. Shareholders may be entitled to a tax offset equal to the franking credits attached to the special dividend.

Non-Australian resident Newcrest shareholders should not be subject to Australian income tax on the special dividend received from Newcrest and, to the extent that the special dividend is franked³, the franked portion should not be subject to Australian dividend withholding tax. However, there may be income tax consequences of receiving the special dividend in their home jurisdiction.

Treatment of Newmont Dividends

After the Newmont Transaction is implemented, Newmont dividends received by Australian resident shareholders, along with any amount withheld by Newmont referable to United States withholding tax (generally 15%), should be included in the assessable income of a shareholder. The dividends will not carry any franking credits but shareholders should be entitled to a foreign income tax offset against the Australian income tax payable on the dividends equal to the amount withheld by Newmont.

Non-Australian resident shareholders should consult their own professional adviser in relation to the tax treatment of any dividends received from Newmont after the Newmont Transaction is implemented.

¹⁰³ If the Newcrest shares held by a non-Australian resident shareholder are "taxable Australian property" as defined in the *Income Tax Assessment Act 1997* (Cth), the foreign resident capital gains withholding tax regime may apply to their shares.

Annexure 1. Independent Expert's Report

GRANT SAMUEL



7.5.7 Other Matters

Transaction Costs

If the Newmont Transaction is not approved by shareholders or otherwise not implemented, Newcrest has estimated that it will meet costs (including legal and other adviser's fees as well as printing and mailing costs) of approximately \$35 million (3.9 cents per share)¹⁰⁴. In certain circumstances, Newcrest will also be liable to pay Newmont a \$174 million break fee. If the Newmont Transaction is implemented, all transaction costs will effectively be borne by Newmont (although Newcrest shareholders will bear approximately 31% of the total costs of the transaction that are incurred and/or paid after the Newmont Transaction is implemented).

Ineligible Foreign Shareholders

Ineligible foreign shareholders (i.e. Newcrest shareholders with registered addresses outside of Australia and its external territories, Canada, New Zealand, Papua New Guinea, the United States, the United Kingdom, the European Union (excluding Austria), Guernsey, Hong Kong, Japan, Norway, Singapore, South Korea, Switzerland, the United Arab Emirates, the Isle of Man and Bermuda) are not entitled to receive Newmont securities. However:

- the Newmont shares which they would otherwise receive will be sold on market (on the NYSE) and they will receive the cash proceeds of sale (after deduction of any reasonable brokerage or other selling costs, taxes and charges), in United States dollars;
- they can acquire Newmont shares through the NYSE (or Newmont CDIs through the ASX or Newmont PDIs through the PNGX) if they wish to retain an exposure to the combined entity; and
- Newcrest has estimated that shareholders representing only around 3% of Newcrest's issued shares are expected to be impacted by these provisions.

7.6 Shareholder Decision

Grant Samuel has been engaged to prepare an independent expert's report setting out whether in its opinion the Newmont Transaction is in the best interests of shareholders and to state reasons for that opinion. Grant Samuel has not been engaged to provide a recommendation to shareholders in relation to the Newmont Transaction, the responsibility for which lies with the directors of Newcrest.

In any event, the decision whether to vote for or against the Newmont Transaction is a matter for individual shareholders based on each shareholder's views as to value and business strategy, their expectations about future economic and market conditions and their particular circumstances including risk profile, liquidity preference, investment strategy, portfolio structure and tax position. In particular, taxation consequences may vary from shareholder to shareholder. If in any doubt as to the action they should take in relation to the Newmont Transaction, shareholders should consult their own professional adviser.

Similarly, it is a matter for individual shareholders as to whether to buy, hold or sell shares in Newcrest or Newmont. These are investment decisions upon which Grant Samuel does not offer an opinion and are independent of a decision on whether to vote for or against the Newmont Transaction. Shareholders should consult their own professional adviser in this regard.

¹⁰⁴ Of the \$35 million, \$23 million has been incurred/accrued by Newmont in its accounts at 30 June 2023 with the remaining \$12 million expected to be recognised after 30 June 2023.

GRANT SAMUEL



8 Qualifications, Declarations and Consents

8.1 Qualifications

The Grant Samuel group of companies provide corporate advisory services in relation to mergers and acquisitions, capital raisings, debt raisings, corporate restructurings and financial matters generally. The primary activity of Grant Samuel & Associates Pty Limited is the preparation of corporate and business valuations and the provision of independent expert's reports in connection with mergers and acquisitions, takeovers and capital reconstructions. Since inception in 1988, Grant Samuel and its related companies have prepared more than 580 public independent expert and appraisal reports.

The persons responsible for preparing this report on behalf of Grant Samuel are Stephen Wilson MCom (Hons) CA SF Fin and Jaye Gardner BCom LLB (Hons) CA SF Fin GAICD. Each has a significant number of years of experience in relevant corporate advisory matters. Stephen Cooper BCom (Hons) CA, Shaun Yu BBA CFA, Mitchell Skene BEng (Hons) BCom and Benjamin Rabjohns BAdvFin&Econ (Hons) assisted in the preparation of the report. Each of the above persons is a representative of Grant Samuel pursuant to its Australian Financial Services Licence under Part 7.6 of the Corporations Act.

8.2 Disclaimers

It is not intended that this report should be used or relied upon for any purpose other than as an expression of Grant Samuel's opinion as to whether the Proposal is in the best interests of shareholders. Grant Samuel expressly disclaims any liability to any Newcrest shareholder who relies or purports to rely on the report for any other purpose and to any other party who relies or purports to rely on the report for any purpose whatsoever.

Grant Samuel has had no involvement in the preparation of the Scheme Booklet issued by Newcrest and has not verified or approved any of the contents of the Scheme Booklet. Grant Samuel does not accept any responsibility for the contents of the Scheme Booklet (except for this report).

8.3 Independence

Grant Samuel and its related entities do not have at the date of this report, and have not had within the previous two years, any business or professional relationship with Newcrest or Newmont or any financial or other interest that could reasonably be regarded as capable of affecting its ability to provide an unbiased opinion in relation to the Newmont Transaction.

Grant Samuel advises that a related entity is currently mandated by the State of PNG's Office of State Negotiations to provide commercial advice in relation to Wafi-Golpu. Grant Samuel does not consider that this assignment would have any impact on its ability to provide an unbiased opinion in relation to the Newmont Transaction.

Grant Samuel had no part in the formulation of the Newmont Transaction. Its only role has been the preparation of this report.

Grant Samuel will receive a fixed fee of A\$2.75 million for the preparation of this report. This fee is not contingent on the conclusions reached or the outcome of the Newmont Transaction. Grant Samuel's out of pocket expenses in relation to the preparation of the report will be reimbursed. Grant Samuel will receive no other benefit for the preparation of this report.

Grant Samuel considers itself to be independent in terms of Regulatory Guide 112 issued by the ASIC on 30 March 2011.

Annexure 1. Independent Expert's Report

GRANT SAMUEL



8.4 Declarations

Newcrest has agreed that it will indemnify Grant Samuel and its employees and officers in respect of any liability suffered or incurred as a result of or in connection with the preparation of the report. This indemnity will not apply in respect of the proportion of any liability found by a court to be primarily caused by any conduct involving negligence, fraud or wilful misconduct by Grant Samuel. Newcrest has also agreed to indemnify Grant Samuel and its employees and officers for time spent and reasonable legal costs and expenses incurred in relation to any inquiry or proceeding initiated by any person. Any claims by Newcrest are limited to an amount equal to the fees paid to Grant Samuel. Where Grant Samuel or its employees and officers are found to have been negligent, fraudulent or engaged in wilful misconduct Grant Samuel shall bear the proportion of such costs caused by its action.

Advance drafts of this report were provided to Newcrest and its advisers. Advance drafts of this report were also provided to Newmont. Certain changes were made to the drafting of the report as a result of the circulation of the draft report. There was no alteration to the methodology, evaluation or conclusions as a result of issuing the drafts.

8.5 Consents

Grant Samuel consents to the issuing of this report in the form and context in which it is to be included in the Scheme Booklet to be sent to shareholders of Newcrest. Neither the whole nor any part of this report nor any reference thereto may be included in any other document without the prior written consent of Grant Samuel as to the form and context in which it appears.

8.6 Other

The accompanying letter dated 7 September 2023 and the Appendices form part of this report.

Grant Samuel has prepared a Financial Services Guide as required by the Corporations Act. The Financial Services Guide is set out at the beginning of this report.

GRANT SAMUEL & ASSOCIATES PTY LIMITED

7 September 2023

Grant Samuel & Associates



GRANT SAMUEL



APPENDIX 1

GLOSSARY OF ABBREVIATIONS AND TECHNICAL TERMS

The following terms used in this report (including the summary letter, the full report and the appendices) have the meanings set out below:

ABBREVIATION	DEFINITION
xQxx	the quarter ended 31 March 20XX (1QXX), 30 June 20XX (2QXX) or 30 September 20XX (3QXX) (i.e. 1Q23 is the quarter ended 31 March 2023) (in relation to Newmont)
1HYxx	the six months ended 30 June 20xx (i.e. 1HY23 is the six months ended 30 June 2023) (in relation to Newmont)
\$	United States dollars
ADRs	American Depositary Receipts
AISC	the cost of sustaining current mining operations and comprises direct cash cost (e.g. on-site mining and processing costs) plus corporate costs, reclamation costs, exploration and study costs, sustaining capital exploration/ development and sustaining capital expenditure. See World Gold Council Guidance Note on Non-GAAP Metrics (November 2018)
AuEq	gold-equivalent
ASX	Australian Securities Exchange
ASIC	Australian Securities & Investments Commission
ATO	Australian Taxation Office
A\$	Australian dollars
Australian Register	that part of the register of members of Newcrest maintained in Australia on behalf of Newcrest by Link Market Services Limited
Canadian Register	that part of the register of members of Newcrest maintained in Canada on behalf of Newcrest by TSX Trust Company
CAPM	Capital Asset Pricing Model
cash flow conversion	operating cash flow before finance costs and tax as a % of EBITDA
CDIs	CHES Depository Interests (listed on the ASX)
CEO	Chief Executive Officer
CFO	Chief Financial Officer
COMEX	Commodity Exchange Division of the New York Mercantile Exchange
Corporations Act	<i>Corporations Act 2001</i> (Cth)
CYXX	calendar year end 31 December 20XX (i.e. CY22 is the year ended 31 December 2022)
C\$	Canadian dollars
DCF	discounted cash flow
DPS	dividends per share
DSTP	deep sea tailings placement
EBITDA	earnings before net interest, tax, depreciation and amortisation, share of profits of equity accounted associates and significant and non-recurring items
EBIT	earnings before net interest, tax, share of profits of equity accounted associates and significant and non-recurring items
ESG	environmental, social and governance
ETF	exchange traded fund
EPS	earnings per share
free cash flow	cash flows from operating activities less cash flows from investing activities (for Newcrest) and net cash provided by/(used in) operating activities less net cash provided by/(used in) operating activities of discontinued operations less additions to property, plant and mine development (for Newmont)
FID	final investment decision
FYXX	financial year end 30 June 20XX (i.e. FY23 is the year ended 30 June 2023)
gearing	net borrowings divided by net assets plus net borrowings
g/t	grams per tonne



Annexure 1. Independent Expert's Report

GRANT SAMUEL



ABBREVIATION	DEFINITION
IFRS	International Financial Reporting Standards
interest cover	EBIT before share of profit/(loss) of associates divided by net interest expense (for Newcrest) or EBIT divided by interest expense (for Newmont)
JORC	Australasian Joint Ore Reserves Committee
km	kilometres
km ²	square kilometres
koz	thousand ounces
kt	thousand tonnes
ktpa	kilotonnes (thousand tonnes) per annum
Latest Share Price	the closing share price on the last practicable date prior to finalising this report (1 September 2023)
lb	pound
LIBOR	London Inter-Bank Offered Rate
LME	London Metal Exchange
LSE	London Stock Exchange
m	metres
Mlb	million pounds
Moody's	Moody's Investors Service
Moz	million ounces
Mt	million tonnes
Mtpa	million tonnes per annum
nmc	not a meaningful calculation
NPAT	net profit after tax
NPV	net present value
NTA	net tangible assets, which is calculated as net assets less intangible assets
NYSE	New York Stock Exchange
oz	troy ounce
PDIs	PETS Depository Interests (listed on the PNGX)
PNG Register	that part of the register of members of Newcrest maintained in Papua New Guinea on behalf of Newcrest by PNG Registries Limited
PNGX	PNGX Markets Limited or, as the context requires, the market operated by it
RG111	Regulatory Guide 111
ROM	run of mine
SAG	semi-autogenous grinding
SEC	United States Securities & Exchange Commission
SHFE	Shanghai Futures Exchange
S&P	Standard & Poor's
State of PNG	The independent State of Papua New Guinea
Subpart 1300	Subpart 1300 of Regulation S-K, promulgated under the United States <i>Securities Act of 1993</i> (as amended)
t	metric tonne
tier 1 gold asset	a commonly used term amongst gold mining companies, defined by Newmont as a mine with annual production of at least 500koz of gold (or gold equivalent), an average AISC in the lower half of the industry cost curve and a mine life in excess of 10 years in countries that are classified in the A and B rating ranges for each of Moody's, S&P and Fitch
TSX	Toronto Stock Exchange
TSX-V	TSX Venture Exchange
tpd	tonnes per day
VWAP	volume weighted average price
US dollars	United States dollars
US GAAP	United States Generally Accepted Accounting Principles



GRANT SAMUEL



APPENDIX 2

PROFILE OF NEWCREST ASSETS

1 Cadia

Overview

The Cadia mining operation is amongst the largest gold mines in the world and the second largest gold mine in Australia (by gold production)¹. It is located 25km southwest of Orange and 200km west of Sydney in New South Wales. The following map shows the location of the Cadia mining operation, which covers 215 km² (six mining leases and five exploration licences):

CADIA – ILLUSTRATIVE MAP OF PROJECT AREA

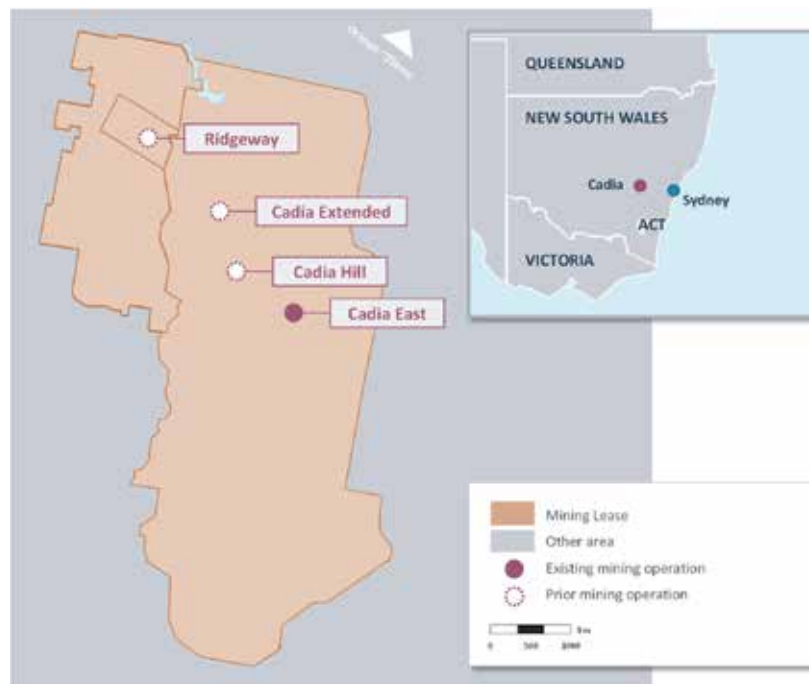

Source: Newcrest

The Cadia district has a long history of exploration and mining dating back over 170 years. Newcrest first acquired the Cadia mining leases in 1991 and discovered the Cadia Hill orebody in 1992. Additional drilling and exploration in the surrounding area uncovered new deposits in Cadia Extended (around 1992), Cadia East (1994) and Ridgeway (1996). The Cadia Hill deposit was the first to be developed and construction of the open cut mine was completed in 1998. The Ridgeway underground sublevel caving mine and Cadia Extended open cut mine were developed shortly afterwards and commenced production in 2002 and 2003, respectively, with Ridgeway expanding into block cave mining in 2009. Collectively, Cadia Hill and Ridgeway produced over 8Moz of gold and nearly 860kt of copper concentrate over their mine lives through 2018 following which the Cadia Hill deposit was largely exhausted and Ridgeway was placed on care and maintenance.

¹ Source: S&P Global Market Intelligence. Based on 2022 calendar year gold production.

Annexure 1. Independent Expert's Report

GRANT SAMUEL



Today, Cadia operations are principally focused on the Cadia East deposit. Mine development at Cadia East commenced in 2012 (with commercial production following in 2013), utilising bulk underground mining methods (block caving/panel caving) to mine the large low grade Cadia East gold/copper orebody. Mining has historically focused on two panel caves — PC1 and PC2. As the ore reserves in the existing panel caves are depleted over the next decade (with production expected to start declining in FY24), new panel cave expansions will be required to extend Cadia's mine life. Newcrest is undertaking major expansion programs at Cadia, namely:

- the Cadia expansion project, of which stage 1 was approved by the Newcrest Board in October 2019, and has an estimated capital cost of \$685 million. This phase of the expansion is centred on the development of the PC2-3 panel caves, which are planned to produce up to 15Mtpa of ore over 15 years (starting FY23). It also includes upgrades to the associated infrastructure and materials handling systems to increase processing plant capacity from 30Mtpa to 33Mtpa (noting that Stage 2 of the Cadia expansion project was approved by the Newcrest Board in October 2020, with an estimated capital cost of \$175 million, and included increasing the processing plant capacity from 33Mtpa to 35Mtpa); and
- the development of Cadia PC1-2 panel cave, which was approved by the Newcrest Board in November 2022 and has an estimated capital cost of \$1.1 billion. This phase of the expansion is focused on the development of the PC1-2 panel cave, planned to produce up to 25Mtpa over 16 years (starting FY26).

Mined ore recovered from the extraction level at the bottom of each cave is crushed in an underground crusher. It is then transported by conveyor to the surface for processing at one of Cadia's two concentrators, which produce both gold doré (via gravity recovery) and copper concentrate. The gold doré is delivered to a gold refinery in Australia to produce refined gold and silver, while the copper concentrate is slurried and pumped along a dedicated pipeline to the Blayney dewatering facility for filtering before being transported by rail to Port Kembla for export to international smelters particularly in Japan and South Korea. The copper concentrates have final mineral grades of 23-26% copper and 28-66 g/t gold as well as trace levels of deleterious materials such as fluorine and molybdenum. A new molybdenum processing plant was commissioned in 2022 to recover molybdenum into a separate molybdenum concentrate, providing an additional revenue stream and reducing the penalties that would otherwise result from excessive molybdenum content in the copper concentrate.

The mine is operated by an onsite workforce totalling approximately 1,200 (and expected to peak at 1,700 when the capital works for the Cadia expansion is underway), most of whom live in Orange.

Based on data published by the World Gold Council², Cadia is one of the lowest cost producers of gold globally. Revenue from its substantial copper production (which effectively is treated as a negative cost) means that Cadia has been able to report negative cash costs of production in recent years. Newcrest anticipates that this position will be maintained following the completion of the expansion project.

Geology and Mineralisation

The Cadia deposits are collectively one of the largest gold deposits in eastern Australia. The largest of these deposits is Cadia East which has a strike length of around 2.5km, is approximately 600m wide and has a vertical extension of over 1,900m. The deposit is part of a large porphyry system and is broadly divided into an upper zone characterised by disseminated copper rich chalcopyrites and a deeper gold-rich zone.

Mining

Underground mining at Cadia East is by panel caving, a form of block caving which moves sequentially along the length of the orebody so that blasting of a section only occurs when the adjacent section has completed production. Panel caving is generally suitable for large scale production from orebodies that

² Source: World Gold Council. Based on data as at 31 December 2022 provided by Metals Focus Gold Mine Cost Services.

GRANT SAMUEL



have a steep dip and large vertical extension as well as suitable rock characteristics that allow for fragmentation (at appropriate coarseness of ROM ore) and recoverability (as panels narrow as mining progresses upwards across the orebody). Compared to standard block caving, panel caving is attractive for its lower upfront development costs as specific areas are targeted in sequence.

Extracting ore by panel caving involves a series of steps:

- development of an access decline to the bottom of the orebody, an undercut level (to blast the ore), an extraction level (to remove the ore) and drawbells (through which ore gravitates from the undercut level to the extraction level);
- undercutting a block of ore to induce caving of the rock mass (which results in “fragmentation” or breaking of the ore);
- removal of the broken ore from the extraction level via load-haul-dump fleet to underground crushing stations; and
- transportation of the crushed ore via conveyor to a coarse ore stockpile at surface. Waste rock is hauled to the surface via the access decline.

The mine layout at Cadia can broadly be split into two areas, the western cave (characterised by large volumes with moderate-to-lower grades) and the eastern cave (characterised by lower volumes but at moderate-to-higher grades). Historically, mining at Cadia East has focused on PC1 (in the western cave) and PC2 (in the eastern cave). The current operations are planned as a series of three lifts within which individual panel caves are located. Lifts 1 and 2 (within which PC1 and PC2 are located, respectively) are approximately 1,200-1,400m in height, whereas Lift 3 is much shorter at 275m but sits below the base of Lift 2 and extends further underground.

The layout of the panel caves within Cadia East is depicted below:

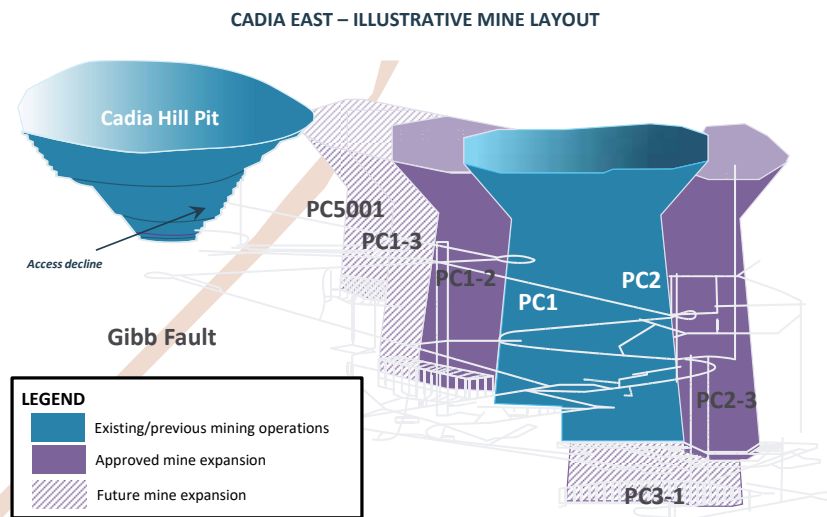

Source: Newcrest

Note: Not all panel cave extensions are included in the illustration above.

Over the past four years, the majority of ore mined was extracted from PC2 (nearly 88%), with the remainder accounted for by PC1 (nearly 10%) and early development works at PC2-3 (less than 3%).

Future mine expansions will be focused on areas adjacent to existing cave operations in both ends of the cave. This includes the recently approved PC2-3 and PC1-2 mine expansions, which will be the first expansions of the Cadia East mine since it was commissioned. These two panel caves are expected to

Annexure 1. Independent Expert's Report

GRANT SAMUEL



exploit over 30% of the remaining ore reserves at Cadia East and support production levels at Cadia over the period to around FY31 during which the subsequent series of panel caves are expected to be developed.

The existing ore reserves at Cadia East support a 40+ year remaining mine life, which will require further panel caves beyond PC1-2 and PC2-3. These expansions are subject to future FID and further studies to confirm the appropriate sequence and design of future panel caves.

Processing

Cadia operates a conventional crushing, grinding and flotation processing plant that has a total processing capacity of up to 35Mtpa. ROM ore from the coarse ore stockpile is fed into a series of secondary and tertiary crushers to screen oversized ore before the ore is processed at one of the two concentrators. Each concentrator adopts a slightly different flowsheet that is adapted for the different grades of ore feed:

- Concentrator 1 typically processes lower grade ore and can process up to 26Mtpa of ore feed; and
- Concentrator 2 typically processes higher grade ore and can process up to 9Mtpa of ore feed.

The concentrate stream produced from the two concentrators are fed into the molybdenum plant where it undergoes further separation, regrinding, thickening and (for the molybdenum concentrate) filtration and drying to produce separate copper and molybdenum concentrates. Newcrest expects the plant to produce up to 4 million lbs of molybdenum per annum.

The final copper concentrate slurry typically has a grade of 23-26% copper and contains gold and silver by-products (with relatively low levels of impurities). The molybdenum concentrate has a grade of 52% molybdenum and is in a dry powder form. Approximately 15% of gold metal in the feed ore is recovered via gold gravity separation and smelted on site to produce gold doré.

Tailings from the treatment process are thickened before they are pumped to one of three on-site tailings storage facilities, including the former Cadia Hill open pit mine. Newcrest expects that the current capacity of the tailings storage facilities at Cadia should support operations through to 2031 (although studies evaluating potential options to increase capacity are underway).

Resources and Reserves

Reported mineral resources at Cadia are summarised below:

CADIA – MINERAL RESOURCES AT 30 JUNE 2023³

	MEASURED				INDICATED				INFERRED				TOTAL VOLUMES			
	Ore (Mt)	GRADE			Ore (Mt)	GRADE			Ore (Mt)	GRADE			Ore (Mt)	Au (Moz)	Cu (Mt)	Ag (Moz)
		Au (g/t)	Cu (%)	Ag (g/t)		Au (g/t)	Cu (%)	Ag (g/t)		Au (g/t)	Cu (%)	Ag (g/t)				
Cadia East Underground	-	-	-	-	2,600	0.35	0.26	0.65	500	0.24	0.17	0.47	3,100	32.80	7.55	61.50
Ridgeway underground	-	-	-	-	110	0.57	0.30	0.74	41	0.38	0.40	0.43	151	2.40	0.48	3.06
Cadia Extended Underground	-	-	-	-	80	0.35	0.19	-	-	-	-	-	80	0.89	0.15	-
Cadia Hill Stockpiles	32	0.30	0.13	-	-	-	-	-	-	-	-	-	32	0.31	0.04	-
Big Cadia	-	-	-	-	-	-	-	-	11	0.70	0.52	-	11	0.25	0.06	-
Total													3,374	37	8	65

Source: Newcrest and Grant Samuel analysis

³ Numbers may not add up due to rounding.



GRANT SAMUEL



Reported ore reserves at Cadia are summarised below:

CADIA – ORE RESERVES AT 30 JUNE 2023³

	PROVED				PROBABLE				TOTAL VOLUMES			
	Ore (Mt)	GRADE			Ore (Mt)	GRADE			Ore (Mt)	Au (Moz)	Cu (Mt)	Ag (Moz)
		Au (g/t)	Cu (%)	Ag (g/t)		Au (g/t)	Cu (%)	Ag (g/t)				
Cadia East Underground	-	-	-	-	1,200	0.42	0.29	0.69	1,200	16.00	3.40	26.00
Ridgeway underground	-	-	-	-	80	0.54	0.28	0.66	80	1.40	0.23	1.70
Total									1,280	17	4	28

Scale: Newcrest and Grant Samuel analysis

The vast majority of Cadia’s mineral resources and ore reserves are located in the Cadia East deposit. Mineral resources at Cadia East are estimated on the basis of a cut-off criteria of A\$18/t net smelter return, reflecting the expected revenue from gold, by-product offsets and breakeven costs (including sustaining capital and development costs). Ore reserves are estimated using a higher cut-off criteria of A\$22.7/t. Cadia East also reported approximately 170kt of molybdenum metal in mineral resources (of which approximately 55% is classified as ore reserves).

The remaining mineral resources and ore reserves represent a small proportion of Cadia’s overall resource base. They include:

- the Ridgeway deposit, which still has unmined ore reserves but was placed on care and maintenance before the ore reserves were fully depleted;
- the Cadia Extended deposit, which contains low grade mineralisation and is based on conceptual designs for a block cave mine (an extension of the previous open pit mine that ceased operations in 2004);
- the Big Cadia deposit, a reasonably shallow orebody that could conceptually be mined by open pit methods but, due to its limited scale, was deemed as an immaterial project for Newcrest; and
- the Cadia Hill stockpile, which is from the former Cadia Hill mine and is generally of lower grade than either Cadia Hill or Ridgeway.

The following chart shows the movements in mineral resources and ore reserves at Cadia in recent years:

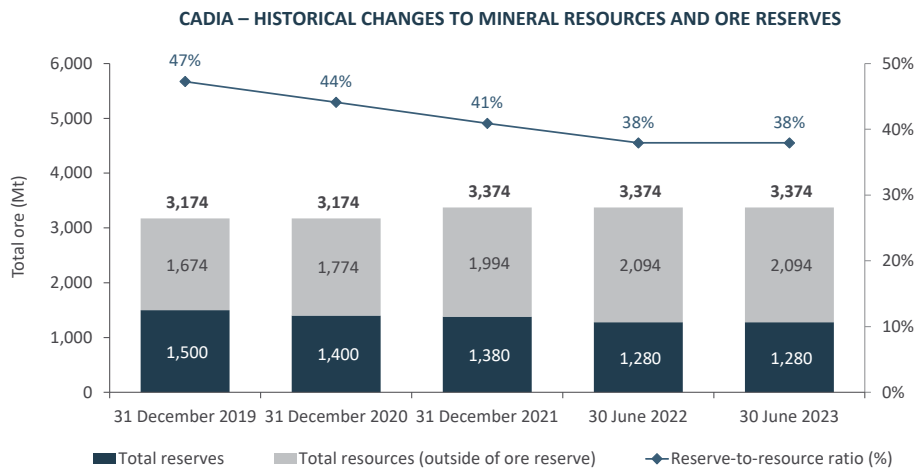

Scale: Newcrest and Grant Samuel analysis

Annexure 1. Independent Expert's Report

GRANT SAMUEL



Due to the large resource base and long reserve life at Cadia, there is relatively limited investment in exploration activity to expand the identified resource base. As a result, the underground ore reserve base has progressively declined due to mining depletion at Cadia East despite the 500Mt uplift in inferred mineral resource in CY21 from the revised mining footprint for PC1-2. These two factors have had the effect of reducing the reserve-to-resource ratio over the period.

This trend is particularly acute for in-situ contained gold and copper metals as mining has generally prioritised higher grade areas. Since CY19, the reserve-to-resource ratio for contained gold metal has declined from nearly 60% to approximately 45% (and from around 50% to just 45% for copper).

Resource conversion (from mineral resource to ore reserves) is expected to be supported in the future by further studies to confirm the feasibility of developing additional panel cave expansions within Cadia East.

Operating Performance

The operating performance of Cadia for FY20 to FY23 is summarised below:

CADIA - OPERATING PERFORMANCE

	FY20 ACTUAL	FY21 ACTUAL	FY22 ACTUAL	FY23 ACTUAL
<i>Total production</i>				
Total material mined (kt)	30,178	33,283	29,204	29,458
Total ore treated (kt)	29,347	32,370	25,861	29,082
<i>Total gold produced (koz)</i>	843	765	561	597
<i>Total copper produced (kt)</i>	96	106	85	98
<i>Head grade</i>				
Gold (g/t)	1.14	0.95	0.87	0.81
Copper (%)	0.39	0.40	0.39	0.40
<i>Financial metrics</i>				
EBITDA (\$ millions)	1,301	1,615	1,229	1,306
AISC (\$/oz)	160	(109)	(124)	45
Capital expenditure (\$ millions)	297	571	685	484
<i>Revenue split</i>				
% of revenue from gold	71%	62%	56%	57%
% of revenue from copper	29%	38%	44%	43%

Source: Newcrest and Grant Samuel analysis

Cadia's operating performance since FY20 has reflected a combination of factors (some of which are temporary and/or non-recurring) including:

- reduced availability of the processing plant. Following a 10% increase in ore mined and treated in FY21, productivity fell in FY22 due to the planned SAG mill motor upgrades in Concentrator 1 as Newcrest re-fitted the Cadia processing plant to meet the higher processing capacity requirements for the mine expansion. These upgrades temporarily reduced mill capacity at Concentrator 1 (which is substantially larger than Concentrator 2) by approximately 40% for nearly 20 weeks;
- declining gold head grades. As Newcrest continues to prioritise higher grade areas of the orebody, higher grade areas have been depleted and average gold head grades have declined from above 1.1 g/t in FY20 to around 0.8 g/t in FY23. Gold head grades are expected to continue to decline as remaining ore reserves have an average gold grade of just over 0.4 g/t; and
- higher capital requirements. Capital expenditures have stepped up since FY20 due to the increased spend associated with the Cadia expansion (e.g. development of PC2-3 and underground/surface infrastructure) and construction capital for the molybdenum processing plant.



GRANT SAMUEL



Notwithstanding the impact of these factors, Cadia’s operating performance has been buoyed by robust commodity prices (particularly copper). Cost metrics such as AISC are measured on a per oz of gold metal sold basis, which excludes the volumes of by-products such as copper, silver and molybdenum but accounts for these revenues (or recoveries) as a by-product credit (i.e. negative cost) instead. Accordingly, AISC has been largely influenced by the volatility in copper prices which climbed from historically low levels in FY20 to record highs in FY22 (and have remained at historically high levels through most of FY23). The copper by-product credits were the primary reason for Cadia’s negative AISC production costs in FY21 (notwithstanding a stronger Australian dollar impacting site costs) and FY22 and remained very low in FY23.

2 Lihir

Overview

The Lihir mining operation is the eighth largest gold mine in the world (by gold production)⁴. It is located on Aniolum Island, the largest of the Lihir Island group of five islands and approximately 900km north-northeast of Port Moresby, Papua New Guinea. The mining operation is situated on the east coast of the island within the Luise Caldera, an extinct volcanic crater that remains geothermally active.

The following map depicts the layout of the Lihir mining operation which covers nearly 260km²:

LIHIR – ILLUSTRATIVE MAP OF PROJECT AREA

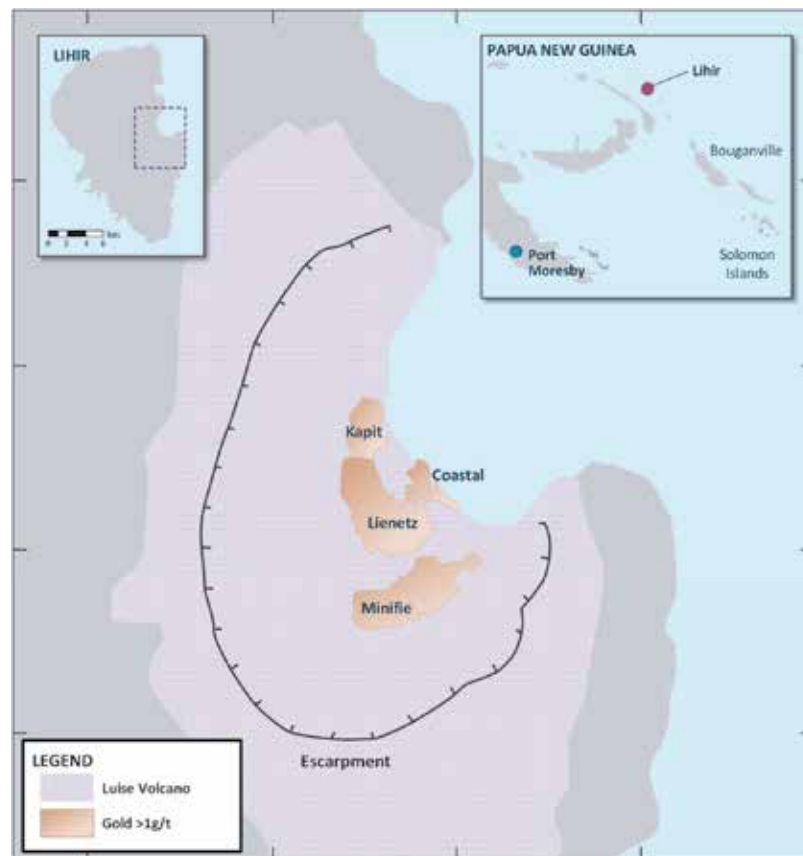

Source: Newcrest

⁴ Source: S&P Global Market Intelligence. Based on 2022 calendar year gold production.

GRANT SAMUEL



Gold mineralisation was first discovered on the island in 1982. Over the next decade, a joint venture between Kennecott Explorations Australia (acquired by Rio Tinto in 1988) and Nuigini Mining Limited undertook an extensive drilling and exploration campaign that resulted in the publication of a feasibility study in 1992 that contemplated the development of an open pit gold mine. Following extensive consultation with the State of PNG, the joint venture was granted a Special Mining Lease in 1995 that gave it exclusive mining rights until 2035 as well as exclusive rights to explore for gold and other minerals on the island. The original project approvals also required the Lihir project and associated Special Mining Lease to be transferred to a new company incorporated in Papua New Guinea (named LGL). Development of the new mine and construction of the processing plant and associated infrastructure commenced later in the year, resulting in the delivery of first gold at Lihir in 1997.

In August 2010, Newcrest acquired Lihir through the merger with LGL. Since the acquisition, Newcrest has invested more than \$4 billion into the mine. Early operational challenges exposed vulnerable parts of the processing plant and resulted in an increase in sustaining capital spend to at least A\$200 million per annum to turnaround plant operations (targeting areas such as uptime, intensity, cost, recoveries and grade). The completion of the MOPU project in 2013 delivered a significant step-up in grinding and processing capacity, increasing throughput and allowing greater operational flexibility in treating different ore types. Changes to the treatment process (e.g. implementation of a partial oxidation process in 2014) provided an additional boost to production rates. More recently, mine optimisation studies such as the front end recovery project and pit optimisation project (i.e. Phase 14A) are expected to unlock additional value for Lihir.

Mining has historically occurred along two mineral zones of the open pit (i.e. Minifie and Leinetz) with future production expected to transition to the higher grade Kapit zone. ROM ore is transported by rear-dump haul trucks to the on-site processing plant, where the ore undergoes milling, flotation, pressure oxidation and leaching to produce gold doré for export to refineries (mostly to the Western Australia Mint in Perth). As at 30 June 2023, Lihir is estimated to have a remaining mine life of around 22 years (or 10 years beyond the expiry of the special mining lease in 2035) and post-mining processing of long-term stockpiles is expected to require an additional five years of operations.

Lihir has a workforce of nearly 4,800 people. The mine is operated by a combination of Newcrest employees and contractors on a fly-in/fly-out basis primarily comprising Papua New Guinea nationals from nearby islands or residents of the island with some expatriate employees from Australia. Specialist mining contractors are used to develop new mining areas along the steep caldera slopes.

The mining operations at Lihir are underpinned by a set of compensation and community agreements that trace their antecedents back to the awarding of the Special Mining Lease in 1995 (and renewed in 2007 and 2020). These agreements require Newcrest to make ongoing royalty payments and other social benefit compensation arrangements to local, provincial and national government bodies as well as landholders.

Based on data published by the World Gold Council², Lihir is positioned towards the middle of the cost curve for gold producers.

Geology and Mineralisation

The Lihir deposits are located near the centre of the Luise Caldera across an area that spans approximately 1.5km by 3.0km (at about 500m in depth). Gold is the only metal of economic significance present within this area. Mineralisation of gold is generally characterised as refractory, which means that gold particles are ultra-fine and disseminated throughout the ore. Mineralisation is grouped into the following zones:

- Minifie, which is the largest mineralisation zone (by area) and extends from surface (50m above sea level) to 250m below sea level;
- Leinetz, which is located north of Minifie and extends deeper into the surface;





GRANT SAMUEL



- Kapit, which is a high grade zone adjacent to Leinetz with mineralisation extending from near the surface to 250m below sea level. It is located approximately 500m north from the western end of Leinetz and is connected by a zone of low-grade mineralisation; and
- Coastal, which remains poorly drilled due to its proximity to the harbour and the narrow nature of its mineralisation.

Within each of these zones, mineralisation generally occurs below a surface-level layer of clay-like material (that is a product of high temperature geothermal activity), under which mineralisation occurs either on a high grade (>3 g/t gold) or low grade (<1 g/t gold) layer deeper beneath the surface. The geothermally active state of the area hosting the Lihir deposits also periodically exposes the ground to very high temperatures as well as seismic activities including earthquake, tsunami and landslide events which may cause slope failures (for example, the major failure of the caldera wall in 2005).

Mining

CURRENT OPERATIONS

Ore is mined by conventional truck and shovel open pit mining methods. Ore and waste are drilled and blasted on 12m benches and mined in a single pass. The majority of ex-pit ore is transported to the processing facility and allocated by gold and sulphur grade based on the blending strategy. Lower grade ore is typically allocated to long-term stockpiles for future processing (an average of approximately 30% of ore mined is stockpiled).

Mining at Lihir is organised into distinct “phases” which represent targeted areas of mineralisation within the open pit. The indicative mine layout is shown below.

LIHIR – ILLUSTRATIVE MINE LAYOUT

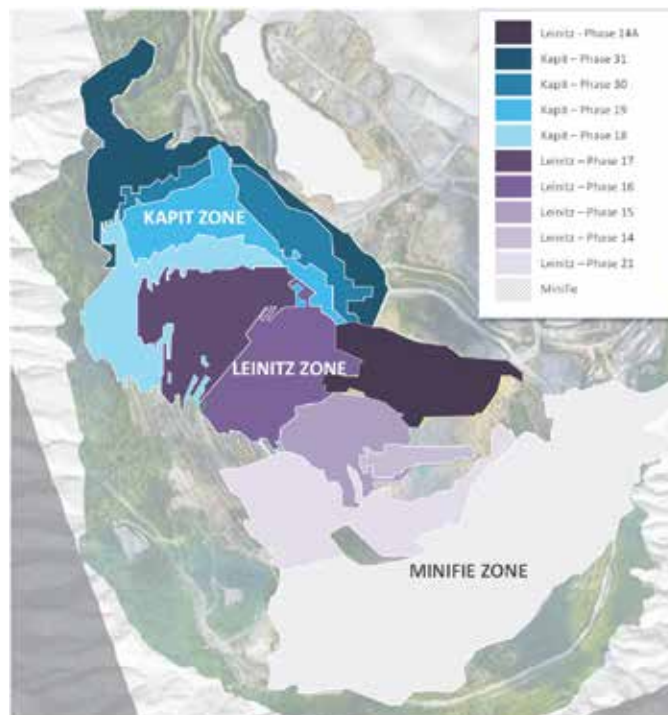

Source: Newcrest

Annexure 1. Independent Expert's Report

GRANT SAMUEL



Historically, mining has focussed on the Minifie and Leinetz zones. The Minifie zone has been largely depleted (with remaining low grade areas deferred towards the end of the mine plan sequence) and mining at the Leinetz zone is nearing completion. Ore in these areas was generally variable in grades and comprised higher amounts of waste rock (including the top layer clay-like material).

Due to the high seismic activity of the region as well as the geothermal conditions, mine walls are typically drilled with controlled blasting techniques to minimise excessive ground vibrations and to ensure stable wall rock conditions. High ground temperatures also mean that conventional explosives may not be safe or practical and specialised blasting products and techniques are required. To reduce the threat to operations from the residual geothermal activity, the temperature and pressure in the vicinity of the pit (as well as within the pit walls) are reduced by discharging steam through surface, shallow and deep wells. Water diversion strategies are also required to mitigate the impact of heavy rainfall and ensure water levels remain below operating thresholds. Dewatering wells pump excess water from the mine site to external holding dams before the water is discharged into the ocean. In recent years, Lihir also installed additional pumping capacity and redesigned the set-up of mining benches to enhance water level mitigation.

Fully exploiting the ore reserves at Lihir will involve several mine expansions.

PHASE 14A EXPANSION

The Phase 14A expansion was approved by the Newcrest Board on 25 January 2023. The \$280 million expansion is an extension of the Phase 14 cutback and involves a steepening of the pit walls (by installing new ground anchors) to access existing mineral resources that would previously been inaccessible through the original mine plan.

Mining of Phase 14A is conducted by a dedicated mining fleet comprising a small excavator and dump trucks. The new mining area is expected to have a very low strip ratio of 0.72 (well below the average strip ratio 1.9 for the rest of Lihir) and involve total ex-pit mining of approximately 35Mt including 13Mt of medium-to-high grade ore (at an average of 3 g/t contained gold). The higher gold grades are expected to result in an uplift in overall mill feed grade as processing of lower grade ore from stockpiles is deferred. Accordingly, the Phase 14A expansion is expected to deliver incremental gold production of approximately 400koz over four years starting FY24.

KAPIT MINE EXPANSION

The expansion into the Kapit zone will target an area of high grade mineralisation at the Lihir deposits. Due to the proximity of the zone to the shoreline, development of the area will require the construction of a new seepage barrier between Luise Harbour and the pit crest. The seepage barrier will be a significant structure. It will be designed to reduce and manage ocean water inflows into the open pit and engineered to provide protection to the planned Kapit pit phase from inflow during earthquake and/or tsunami events. In the absence of a seepage barrier, Newcrest would be prevented from accessing the majority of the Kapit ore body (as the impacted areas are estimated to comprise more than 95Mt of ore reserves).

Since 2013, Newcrest has evaluated a number of alternatives including the construction of:

- 2013 PFS coffer dam, which would involve a significant capital outlay but would maximise access to ore inventory; and
- Kapit Seepage Barrier ("KSB"), which balances the upfront capital requirements against the upside to ore reserves. The KSB involves the combination of a clay infill of the inner harbour and a cut-off wall enclosure. This solution has been Newcrest's preferred approach since 2016-2022.

However, each of these options would require long construction lead times of around 5-6 years (meaning that commencement of mining at Kapit is unlikely to occur until after FY28). Following the completion of the KSB feasibility study in October 2021, Newcrest began investigating the merits of an alternative barrier



GRANT SAMUEL



design, known as the nearshore soil barrier. This alternative will still be constructed through similar mine waste rock and marine sediments as the KSB but will be built to approximately half the depth and length contemplated under the previous option. As a result, the new design will be faster to construct and require less capital. This design remains in conceptual studies (pre-feasibility study is expected to be complete by the end of 2023). Alternative methods such as steep wall technologies (at a much larger scale than in Phase 14A) are also being investigated to unlock additional ore from the Phase 35 zone but remain at even earlier stages.

Commencing mining operations in the Kapit zone will also require other preliminary works including completion of the processing (or relocation) of the Kapit stockpile, progressive pre-stripping of overlying waste rock (more than 200Mt in total) and construction of new water management infrastructure. Geothermal activity is even more elevated in the Kapit area. Geothermal cooling and depressurisation in the area has been underway since 2004 to ensure ground temperatures can be reduced to a level where mining can be safely undertaken.

Processing

As most of the ROM ore from Lihir is refractory, special treatment is required to liberate gold particles that are encapsulated from the sulphide mineralisation prior to leach processing. Accordingly, Newcrest adopts pressure oxidation techniques to extract gold. The process broadly involves the following steps:

- primary crushing, which reduces the ROM ore into finer crushed feed ore. Primary crushing occurs in one of two circuits (one with a gyratory crusher and the other with two jaw crushers in parallel);
- grinding, which reduces the crushed feed ore into pebbles that is then thickened and washed into a thickened ore slurry. The slurry is segregated as either flotation feed ore ("FGO") or direct feed high grade ore ("HGO");
- flotation, which subjects the FGO to a high intensity cleaning to produce a higher grade slurry and minimise impurities and deleterious materials;
- pressure oxidation, which pumps the HGO and upgraded FGO into four parallel autoclave circuits where the feed slurry is subjected to intense heat and pressure to liberate the minerals;
- cyanide leaching and electrowinning, which utilises conventional carbon-in-leach technologies to liberate gold from the slurry to produce a high grade gold sludge; and
- smelting, which dries and heats the sludge to produce gold doré bars.

Since Newcrest's acquisition, substantial investments have been made into Lihir's processing plant. This includes the transformational MOPU project as well as smaller scale debottlenecking and productivity improvement initiatives. The most recent of these was the Lihir Front End Recovery Project (that was approved by the Newcrest Board in October 2020) and aimed to increase overall gold recovery rates by improving grinding classification and reducing gold losses through the flotation circuits.

Notwithstanding these investments, the processing plant has a substantially lower throughput capacity (of up to approximately 15.5Mtpa) than the ore mining rate. The imbalance between the ore mining rate and processing capacity at Lihir requires Newcrest to adopt an "elevated cut-off strategy" under which plant feed is prioritised in the following order:

- high grade ore (greater than 3 g/t), which is always fed to the plant first;
- medium grade ore (2 to 3 g/t), which is partially blended with other ore types; and
- low grade ore (greater than 1.0 g/t and less than 1.6 g/t), which is stored in long-term stockpiles at the Kapit North Stockpile (and other dedicated areas across the mine) for progressive processing over the life of the mine. Approximately 30% of ROM ore falls under this category.

Annexure 1. Independent Expert's Report

GRANT SAMUEL



As a result, the expected closure date for the processing plant is expected to be beyond that for the mining operation as low grade stockpiles are processed only at the end of the mine life (after higher grade ore feed is depleted). Based on Newcrest's estimates, Lihir is expected to stockpile approximately 80-90Mt of low grade ore over the life of mine that will be fed to the plant at the end of mining operations.

Tailings from the plant are disposed through deep sea tailings placement via a pipeline that discharges the tailings stream more than 125m below sea level (below the surface mixing layer of the ocean) within the boundaries of the Special Mining Lease.

Resources and Reserves

Reported mineral resources at Lihir are summarised below:

LIHIR – MINERAL RESOURCES AT 30 JUNE 2023³

	MEASURED			INDICATED			INFERRED			TOTAL VOLUMES		
	Ore (Mt)	GRADE		Ore (Mt)	GRADE		Ore (Mt)	GRADE		Ore (Mt)	Au (Moz)	Cu (Mt)
		Au (g/t)	Cu (%)		Au (g/t)	Cu (%)		Au (g/t)	Cu (%)			
Lihir open pit	-	-	-	490	2.3	-	66	2.3	-	556	40.9	-
Lihir stockpiles	57	1.9	-	21	1.4	-	-	-	-	78	4.4	-
Total										634	45	-

Source: Newcrest and Grant Samuel analysis

Reported ore reserves at Lihir are summarised below:

LIHIR – ORE RESERVES AT 30 JUNE 2023³

	PROVED			PROBABLE			TOTAL VOLUMES		
	Ore (Mt)	GRADE		Ore (Mt)	GRADE		Ore (Mt)	Au (Moz)	Cu (Mt)
		Au (g/t)	Cu (%)		Au (g/t)	Cu (%)			
Lihir open pit	-	-	-	220	2.50	-	220	18.0	-
Lihir stockpiles	57	1.90	-	26	1.70	-	83	4.5	-
Total							303	22.5	

Source: Newcrest and Grant Samuel analysis

Mineral resources and ore reserves at Lihir are both estimated on the basis of a cut-off grade of 1.0 g/t gold, reflecting the substantially lower marginal site costs for the end of mine life low grade stockpile reclamation strategy but also the higher processing costs associated with refractory gold.

The vast majority of Lihir's mineral resources and ore reserves remain in situ and are generally of medium-to-higher grades (including nearly 1Moz of high grade gold in ore reserves unlocked by the Phase 14A expansion). In contrast, the lower grades in the Lihir stockpile reflects the "elevated cut-off strategy" adopted at the site. While the stockpiles appear to be reaching its estimated capacity, Lihir has historically selectively drawn down ore from the low grade stockpile for blending purposes.

The following chart shows the movements in mineral resources and ore reserves at Lihir in recent years:



GRANT SAMUEL



LIHIR – HISTORICAL CHANGES TO MINERAL RESOURCES AND ORE RESERVES

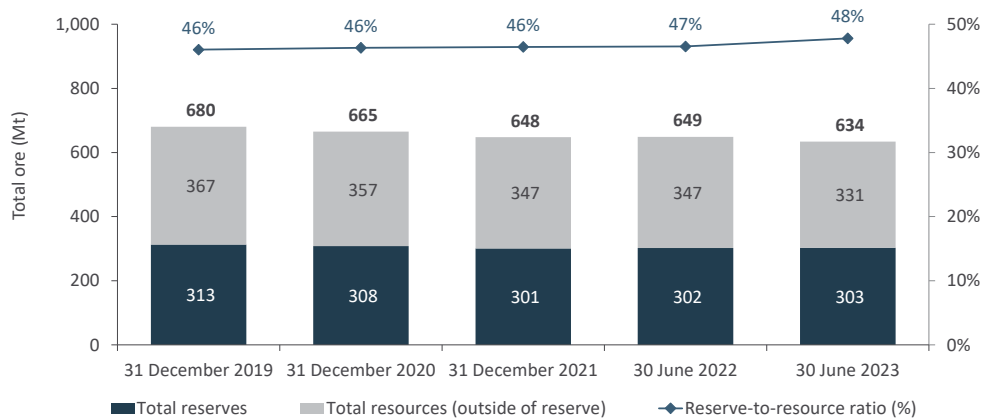

Source: Newcrest and Grant Samuel analysis

The relatively stable profile of Lihir's mineral resource and ore reserve base reflects the extensive drilling and exploration that has been, and continues to be, undertaken as well as the well understood geology of the area and underlying resource base. Accordingly, mineral resource and ore reserve depletion has been relatively minor despite the scale of mining depletion (approximately 55Mt of ore mined since CY19) as the declines have been mostly offset with new mineral resource and ore reserve recognition during the same period (including the 1Moz of ore reserves recognised following the Phase 14A studies).

Operating Performance

The operating performance of Lihir for FY20 to FY23 is summarised below:

LIHIR - OPERATING PERFORMANCE

	FY20 ACTUAL	FY21 ACTUAL	FY22 ACTUAL	FY23 ACTUAL
Total production				
Ex-pit material movements (kt)	30,085	33,467	38,308	38,833
Total ore mined (kt)	12,030	8,662	11,314	17,785
Total waste mined (kt)	18,055	24,805	26,994	21,048
Total ore treated (kt)	13,798	12,791	12,212	11,983
Total gold produced (koz)	776	737	687	670
Head grade				
Gold (g/t)	2.38	2.40	2.35	2.27
Financial metrics				
EBITDA (\$ millions)	465	590	446	455
AISC (\$/oz)	1,206	1,391	1,622	1,466
Capital expenditure (\$ millions)	235	299	365	286
Revenue split				
% of revenue from gold	100%	100%	100%	100%
% of revenue from copper	--	--	--	--

Source: Newcrest and Grant Samuel analysis

Annexure 1. Independent Expert's Report

GRANT SAMUEL



Lihir's operating performance since FY20 has deteriorated:

- total ore treated fell to around 12Mtpa despite briefly reaching nameplate capacity of 15.5Mtpa in late FY20; and
- total gold production fell to around 680koz per annum from highs of over 900koz per annum in the years FY16 through to FY19.

The performance reflects a number of operational challenges during this period. Increased maintenance activities and plant shutdowns reduced ore treatment volumes. Planned events such as the move towards a bi-annual plant shutdown strategy in FY20 aimed to improve future equipment reliability and utilisation but required more frequent scheduled plant shutdowns to undertake maintenance works. Unplanned events resulted in unexpected downtimes of processing infrastructure. These unplanned events included the unplanned shutdown of the HGO mills and autoclaves in FY20, the crusher and autoclave outage in FY21 and other unscheduled maintenance activities in FY22 and FY23.

A number of other factors such as challenging geothermal conditions (which presented a difficult mining environment in FY20 as abnormally high ground temperatures restricted blasting in certain areas of the mine) and adverse weather conditions (from significant rainfall in FY21 to extended drought conditions in FY22 and FY23) also contributed to the weaker operating performance.

Costs (i.e. AISC) have climbed to historically high levels (previously around \$850-950/oz) and have generally trended in line with the movements in capital expenditure. The elevated costs are largely attributable to the increased sustaining capital investments, higher stripping activities (as mining progresses to Phases 16 and 17 of the mine) and reduced fixed cost absorption due to lower gold production.

Moreover, increasing stockpile management requirements have had an impact on Lihir's cost levels. Unlike in other mineral assets operated by Newcrest, a large proportion of activity at Lihir involves managing its ore stockpiles (including reclaiming the stockpile for mill feed as well as relocating stockpiles). In FY23, Lihir has had to move an average of 2.7t of ore⁵ for every tonne of ore that is ultimately treated at the processing plant (up from 2.5t in FY20).

Notwithstanding these issues, early results from recent investments offer signs of improvement. The mining improvement program delivered two new shovels, which together with the truck-rebuild program, have improved ore mining rates. Head grades of feed ore have remained broadly stable as blending strategies reduced input from lower grade stockpiles. Operating performance for FY23 has been consistently stronger than the prior year in terms of ore mined, material moved, and costs, albeit FY23 was weaker in terms of head grades and overall gold production. Further uplifts from the Phase 14A expansion and front end recovery project have yet to be fully realised in Lihir's operating performance.

3 Telfer

Overview

The Telfer mining operation is a gold-copper mine located in the Paterson Province in Western Australia, approximately 400km south-east of Port Hedland. The Telfer mine was historically one of the largest gold mines in the world. Since commencing mining operations in 1975, Telfer has produced more than 15Moz of gold. The following map depicts the layout of the Telfer mining operation which covers nearly 1,700km²:

⁵ Ore moved comprises ore mined, ore rehandled and ore draw/added to stockpile.

GRANT SAMUEL



TELFER – ILLUSTRATIVE MAP OF PROJECT AREA



Source: Newcrest

Gold-bearing mineralisation in the Telfer district was first discovered in the early 1970s, following which a joint venture between Newmont Australia and BHP Gold developed the Telfer open pit mine in 1975. The majority of the ore reserves at the time comprised oxide ores. Ongoing exploration in the surrounding area identified additional sulphide-ore bearing reefs (i.e. sheets or veins) at depth on the eastern side of the open pit mine. In 1990, Telfer commenced underground mining operations to exploit these newly found sulphide deposits. Ownership of the mine was subsequently consolidated under Newcrest following the merger of the two joint venture partners.

The combination of escalating costs, falling gold prices and processing constraints arising from the increasing proportion of sulphide inventories (which could not be economically processed under the previous processing flowsheet) led to the suspension of operations in October 2000. Further studies were completed in subsequent years to develop a single (albeit complex) treatment method capable of processing a combination of open pit and underground ore. A new processing plant was constructed and the Telfer mining operation was recommissioned in 2004 and has been in operation since.

Today, Telfer is a combined open pit and underground mining operation. ROM ore is transported and fed into the on-site processing plant where the ore undergoes a complex milling, flotation and leaching treatment process to produce gold-bearing copper concentrate (containing 13-19% copper and 50-90 g/t gold) and gold doré. Concentrate is trucked to Port Hedland where it is stored in an enclosed concentrate storage facility before being loaded on to vessels for export to smelters primarily in the Eastern Asia region. Gold doré is security transported by air freight from the mine site to the Western Australia Mint in Perth for further processing. The site is operated by approximately 1,700 fly-in fly-out full time equivalent staff and

Annexure 1. Independent Expert's Report

GRANT SAMUEL



contractors. Mining operations are handled by Macmahon Holdings Limited (open pit) and Byrnescut Group (underground), whereas processing operations are handled by Newcrest employees.

Following over 40 years of production, the mine is entering the “twilight” of its production life as ore reserves within the Telfer area approach exhaustion. The West Dome Stage 5 cutback expansion was announced in late 2021 and is currently in operation. In the following year, the Newcrest Board approved the West Dome Stage 8 cutback program to support mining operations into FY25. Newcrest continues to undertake further exploration drilling and testing to extend the mine life at the open pit (e.g. additional cutbacks) and underground (e.g. vertical stockwork corridor and other exploration fronts). However, no further announcements have been made to extend the mine life beyond FY25 at this stage.

Accordingly, Newcrest has entered into a number of exploration ventures in the surrounding Paterson Province. The most promising of these is the Havieron project (in which Newcrest holds a 70% interest) which is located 45km east of the Telfer operation and offers the potential to be a capital-efficient development given its proximity to existing processing infrastructure at Telfer. The Havieron project has achieved the following milestones:

- in March 2019, entry into an exploration farm-in agreement with Greatland, which enabled Newcrest to earn a 70% interest in the joint venture if it met certain exploration expenditure targets and delivered a pre-feasibility study (as well as an option to acquire an additional 5% interest at the end of the farm-in period which Newcrest ultimately declined to exercise);
- in November 2020, entry into a fully-termed joint venture agreement that provides the formal framework between the two parties beyond the farm-in agreement;
- in December 2020, announcement of an initial mineral resource estimate;
- in January 2021, funding approval from the Newcrest Board to construct the box cut, exploration decline and associated surface infrastructure; and
- in October 2021, completion of a pre-feasibility study which demonstrated the potential for a new underground mine that can produce approximately 2Mtpa of ore (approximately 160koz of gold per annum and 7ktpa copper) over a nine year mine life. Estimated development capital is approximately A\$530 million.

Newcrest is currently preparing a feasibility study for a moderately larger scale operation (around 3Mtpa).

Newcrest has also entered into separate exploration agreements with Antipa (in relation to Wilki) and Greatland (in relation to the Juri Joint Venture) for further exploration in the region. Exploration and drilling are underway.

Telfer and Havieron are subject to a number of third party agreements and compensation and community development agreements that require it to make ongoing royalty payments and social benefit compensation payments.

Based on data published by the World Gold Council², Telfer is positioned towards the middle of the cost curve for gold producers partly due to increasing site costs and lack of copper by-product credits. If developed, the Havieron project is expected to improve Telfer's position along the cost curve due to its substantially higher gold grades.

Geology and Mineralisation

The Telfer mine site is dominated by two large scale asymmetric dome structures with steep west dipping axial planes. Main Dome is located in the southeast portion of the mine and is exposed over a strike distance of 3km north-south and 2km east-west. West Dome is located in the northwest area of the mine and has similar dimensions to Main Dome. Mineralisation is generally found within high grade reefs and



GRANT SAMUEL



lower grade stockworks (i.e. complex formation of compact but irregularly oriented veins) across three distinct areas:

- near-surface stockwork and reef mineralisation within Main Dome and West Dome;
- underground stockwork and reef mineralisation directly below the Main Dome; and
- vertical stockwork corridor that occur at depth below existing underground mining operations.

Copper minerals generally occur as sulphides such as chalcopyrite, chalcocite and bornite. Gold minerals generally occur as free grains that are associated with sulphides. Oxide mineralisation (of economic significance) has largely been exhausted from past mining.

The Havieron gold-copper deposit primarily comprises sulphide mineralisation (i.e. chalcopyrite and pyrite) across an ovoid-shaped zone of approximately 650m in length and 350m in width (and at depths of up to 1,200m). Initial drilling indicates higher occurrences of mineralisation closer to the surface, which progressively declines at depth. Mineralisation occurs generally in two separate zones known as the Southeast Crescent Zone (with high grade gold mineralisation associated with sulphides) and the Breccia Zone (which continues to be defined through exploration drilling and early stage evaluations).

O'Callaghans and Camp Dome are two standalone deposits that lie within 20km of the Telfer deposit, while the Satellites deposits represents an additional group of deposits peripheral to the mine (albeit only 5Mt has been reported to date). Mineralisation at O'Callaghans primarily comprises tungsten, copper, zinc and lead (as well as some elements of molybdenum and silver). On the other hand, Camp Dome is a copper-only deposit. Gold is not present in economically significant amounts at either of the deposits.

Mining

CURRENT OPERATIONS

Telfer's mining operations can be separated into two distinct operations:

- open pit mining at West Dome (and previously Main Dome); and
- underground mining at Telfer Underground.

TELFER – INDICATIVE MINE LAYOUT

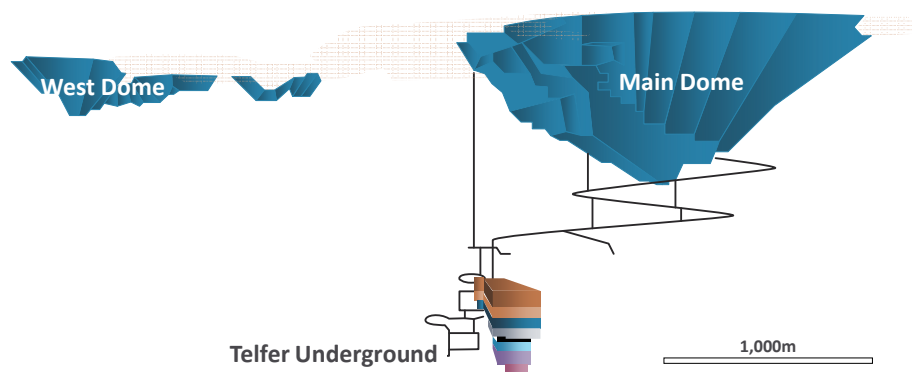

Source: Newcrest

Open pit mining is conducted by conventional truck and shovel mining methods. Newcrest utilises a fleet of excavators, front end loaders and rigid off-highway dump trucks to selectively extract ore material from 12m tall benches that comprise three 4m high passes (i.e. to minimise ore dilution and loss). ROM ore can be in the form of direct flotation grade ore (which is hauled to the processing plant for treatment) or near-

GRANT SAMUEL



surface oxidised stockwork (which is placed on pads located west of the Main Dome pit for dump leaching treatment). The open pit mine is designed to have an ore production capacity of up to 17-18Mtpa (depending on mining front).

Underground mining is primarily conducted via sub-level caving, which unlike block caving, allows the orebody to progressively “cave” over a series of parallel sublevels in a top-down sequence (as opposed to bottom-up). The ore above the sublevel is drilled, following which the drillholes are charged and fired to allow the broken ore to fall into the sublevel, where the ore is recovered and subsequently tipped down an ore pass system to the haulage level. The ore is then trucked to the underground crushing station and lifted by a hoisting shaft to the surface. Different mining methods such as open stope mining or paste fill stope mining are selectively used for higher grade areas of reef mineralisation. ROM ore from this mining front is trucked directly to a surface stockpile. The underground mine is designed to have an ore production capacity of up to 6Mtpa.

HAVIERON PROJECT

Mining the Havieron deposit is expected to focus on the Southeast Crescent Zone. Mining will be undertaken via underground sub-level open stoping methods. Mining the orebody will occur at multiple levels (spaced approximately 50-60m apart) in parallel via stopes that will be mined in a top-down checkerboard fashion (prioritising higher grade ore closer to the surface).

ROM ore will be hauled by truck to the surface via the access decline then transported to the existing processing infrastructure at the Telfer mining centre via a new 55km long unsealed road. Due to the substantially smaller operating footprint, Newcrest anticipates a workforce of only 380 employees (or 120 per shift).

The development (and ramp-up) of the Havieron project is expected to coincide with the ramp down of the existing Telfer mining operations, however the timing of mine development and first ore at Havieron is still subject to further studies.

Processing

The treatment flowsheet for Telfer is relatively complex due to the wide variation in mineralisation grades and hardness of the ore feed. The coarse ore stockpile (which sources sulphide ores and other moderate-to-high grade ROM ore from both underground and open pit mines) are typically blended in order to manage the ore grade and hardness of the ore feed.

The processing plant has two parallel process lines that collectively have a nameplate capacity of approximately 20Mtpa (although actual throughput rates have been higher). Train 1 receives a blend of underground and open pit ore whereas Train 2 solely treats open pit ore. The majority of the ore feed is processed in a sequential flowsheet involving the following steps:

- crushing and grinding, which reduces the ore to more consistent sizes;
- flash flotation and gravity recovery, which captures coarse free copper and gold mineralisation that is liberated early in the process route (to produce gold doré);
- copper flotation, which recovers the residual copper as well as associated gold mineralisation (to produce copper-gold concentrate);
- pyrite flotation, which receives the tailings from the copper flotation circuit to recover pyrite concentrate; and
- cyanidation leach circuit, which treats the pyrite concentrate after which gold can be extracted from the leach liquor via carbon-in-leach methods followed by stripping and electrowinning (to produce gold doré, which represents around 5% of total gold doré produced at Telfer).

GRANT SAMUEL



The flotation circuit of both process trains can also be reconfigured to run different sequences or modes depending on the mineralogy and characteristics of the feed (e.g. mineral grades, hardness, etc.).

Low grade oxide ores from near-surface oxidised stockwork are treated separately via a dump leach operation. Dump leach ore is taken directly from the mine and stacked on leach pads without crushing. The ore is then treated with a cyanide solution that dissolves gold into a solution that is collected and reincorporated into gold doré production.

Tailings are stored at several on-site storage facilities. The current one in use is approximately 2.5km in diameter and can be constructed up to 60m in height. Waste from the mined ore can be used for the construction of the tailings storage facilities.

Subject to a positive feasibility study and a subsequent decision to mine, the Havieron project is expected to leverage the existing processing infrastructure at Telfer. Given the project's smaller scale, only one processing train will be required but it will need certain modifications to accommodate the reduced mine production rate and the different characteristics of the ore feed (i.e. installation of magnetic separation in the flotation circuit to reduce higher levels of contaminants such as pyrrhotite). Tailings will be deposited at Telfer's existing tailings storage facility.

Resources and Reserves

Reported mineral resources (100% basis) at Telfer are summarised below:

TELFER – MINERAL RESOURCES AT 30 JUNE 2023 (100% BASIS)³

	MEASURED			INDICATED			INFERRED			TOTAL VOLUMES		
	Ore (Mt)	GRADE		Ore (Mt)	GRADE		Ore (Mt)	GRADE		Ore (Mt)	Au (Moz)	Cu (Mt)
		Au (g/t)	Cu (%)		Au (g/t)	Cu (%)		Au (g/t)	Cu (%)			
Open Pit Stockpiles	3	0.41	0.14	7	0.37	0.05	-	-	-	10	0.13	0.01
West Dome Open Pit	-	-	-	39	0.75	0.05	1.6	0.85	0.04	41	0.93	0.02
Telfer Underground	-	-	-	29	1.90	0.44	14	1.50	0.40	43	2.50	0.19
Operating										94	3.6	0.2
Havieron	-	-	-	28	3.20	0.51	57	1.40	0.14	85	5.50	0.22
Satellites deposits	-	-	-	0	2.90	-	4	1.10	-	5	0.20	-
O'Callaghans	-	-	-	63	-	0.30	7	-	0.26	70	-	0.21
Camp Dome	-	-	-	-	-	-	14	-	0.37	14	-	0.05
Non-operating										173	5.7	0.5
Total										267	9.3	0.7

³ Newcrest and Grant Samuel analysis

Reported ore reserves (100% basis) at Telfer are summarised below:

Annexure 1. Independent Expert's Report

GRANT SAMUEL

TELFER – ORE RESERVES AT 30 JUNE 2023 (100% BASIS)³

	PROVED			PROBABLE			TOTAL VOLUMES		
	Ore (Mt)	GRADE		Ore (Mt)	GRADE		Ore (Mt)	Au (Moz)	Cu (Mt)
		Au (g/t)	Cu (%)		Au (g/t)	Cu (%)			
Open Pit Stockpiles	--	--	--	2	0.43	0.10	2	0.02	0.00
West Dome Open Pit	--	--	--	23	0.83	0.07	23	0.62	0.02
Telfer Underground	--	--	--	2	2.10	0.69	2	0.14	0.01
Operating							27	0.8	0.0
Havieron	--	--	--	14	3.70	0.54	14	1.60	0.07
Non-operating							14	1.6	0.1
Total							41	2.4	0.1

Source: Newcrest and Grant Samuel analysis

The cut-off criteria for the mineral resources and ore reserves for the existing operations vary depending on whether it is from the open pit (lower costs of around A\$22.50/t NSR) or the underground deposit (higher costs at a variable cut-off of A\$46.55-148/t NSR). As higher criteria areas of the Telfer deposit have been depleted over the decades of operations, the majority of remaining ore inventory is lower grade in nature although some moderately higher grade ore (>1 g/t gold) still remains in the underground deposit. Save for West Dome Stage 8 and incremental underground extensions, no new reserves have been reported for potential mine extension areas such as the additional stages of open pit cutbacks or underground areas such as the vertical stockwork corridor.

Non-operating (i.e. exploration) assets comprise more than half of the gold and copper contained in Telfer's mineral resources. Havieron is the most advanced of the projects and is the only exploration asset with any recognised ore reserves. Mineral resources at Havieron are estimated on the basis of a variable cut-off criteria of A\$50-100/t NSR (and an ore reserve cut-off criteria of A\$130/t NSR). The cut-off criteria are broadly in line with (if not at the top end of) the cut-off range for Telfer's underground operations and reflect a balance of the higher gold grades at Havieron against its higher haulage costs.

No resources have been recognised by Newcrest for other exploration targets (including those targeted by the Juri Joint Venture and Wilki Joint Venture) at the date of this report.

The following chart shows the movements in mineral resources and ore reserves at Telfer in recent years:

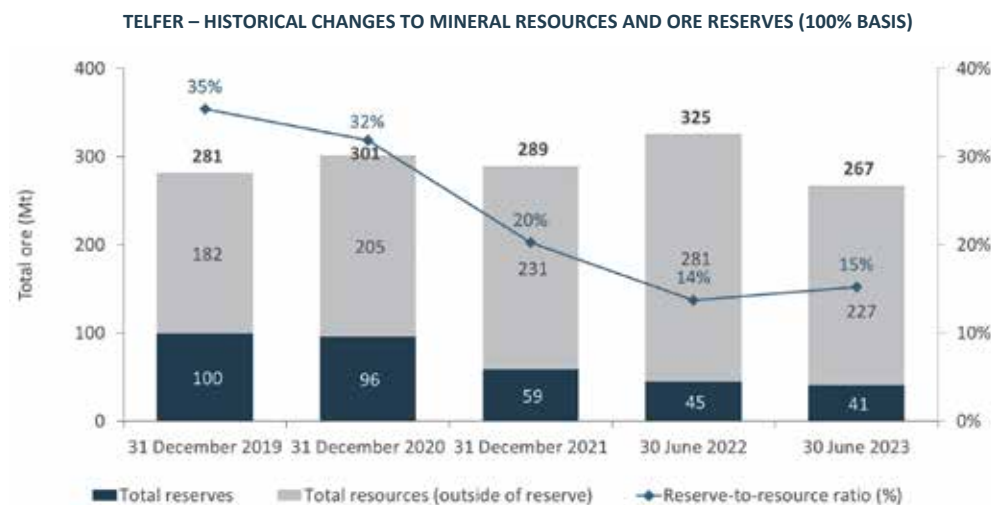

Source: Newcrest and Grant Samuel analysis

GRANT SAMUEL



Movements in Telfer's reported mineral resource and ore reserves demonstrates the impact of mining depletion at the open pit and underground mines as well as the investments in exploration and drilling Newcrest has undertaken in the surrounding Paterson Province. Mineral resources grew by nearly 45Mt (over 15% in aggregate) between 31 December 2019 and 30 June 2022 as mineral resources declared at Havieron offset the mining depletion from the Telfer mining operations.

In particular, continued mineral resource definition at Havieron resulted in the following announcements:

- on 31 December 2020, the declaration of an initial inferred mineral resource of 52Mt (containing approximately 3.4Moz gold and 0.2Mt copper);
- on 12 October 2021, an updated mineral resource and ore reserve estimate following the completion of the pre-feasibility study. The updated statement upgraded the mineral resource from inferred to indicated and declared initial ore reserves of 14Mt (containing 1.6Moz gold and 0.1Mt copper); and
- on 30 June 2022, an increase to the mineral resource estimate from 52Mt to 85Mt (resulting in a indicated mineral resource of 28Mt and an inferred mineral resource of 57M). This represented an additional 1.9Moz of gold in resource.

However, this was offset by the decline in mineral resource in FY23 as a result of increased cost assumptions and a revised pit design at West Dome. Separately, Newcrest's decision to withdraw 44Mt of ore reserves at O'Callaghans (which had a 56% implied reserve-to-resource ratio) in CY20 contributed to a steep decline in reported ore reserves as well as a deterioration in the implied reserve-to-resource ratio. This was partly offset by an initial ore reserve declared at Havieron in CY21.

Operating Performance

The operating performance of Telfer for FY20 to FY23 is summarised below:

TELFER - OPERATING PERFORMANCE

	FY20 ACTUAL	FY21 ACTUAL	FY22 ACTUAL	FY23 ACTUAL
<i>Total production</i>				
Total material mined (kt)	55,107	47,335	38,292	39,294
Total ore treated (kt)	16,210	17,932	20,402	18,725
Total gold produced (koz)	393	416	408	349
Total copper produced (kt)	16	13	14	17
<i>Head grade</i>				
Gold (g/t)	0.90	0.89	0.73	0.67
Copper (%)	0.14	0.11	0.09	0.12
<i>Financial metrics</i>				
EBITDA (\$ millions)	103	137	203	124
AISC (\$/oz)	1,281	1,473	1,388	1,637
Capital expenditure (\$ millions)	56	65	64	92
<i>Revenue split</i>				
% of revenue from gold	85%	86%	83%	80%
% of revenue from copper	15%	14%	17%	20%

Source: Newcrest and Grant Samuel analysis

Telfer consistently produced approximately 400koz of gold per annum between FY20 and FY22 despite declining ore grades as reduced downtimes at the processing plant facilitated higher throughput of treated ore. The ramp-up in processing throughput stalled in FY23 as a result of two separate planned maintenance shutdown of the process trains and temporary shutdown due to Cyclone Ilsa.

Annexure 1. Independent Expert's Report

GRANT SAMUEL



The vast majority of material mined continues to be sourced from the West Dome open pit which entails a substantial amount of waste stripping that can vary depending on the phase of the mining sequence. The very high material mining rate in FY20 was impacted by the pre-stripping campaign that involved a high amount of waste (rather than ore) mined. These upfront “preparatory” works were required to expose more ore for treatment in subsequent years (albeit at declining head grades). Accordingly, cash costs (as measured in AISC) have trended upwards and reached historically high levels in FY21 (and again in FY23). Costs have also been impacted by declining grades, unfavourable exchange rate movements and production stripping at a series of cutbacks (e.g. Stage 5 in FY21 and Stage 8 in FY23).

Capital expenditure has remained broadly consistent at around \$60 million per annum (well below levels incurred in the 2010s), reflecting the limited remaining life of the mine. The uptick in capital expenditure in FY23 reflects the investments in the West Dome Stage 8 cutback which was approved in November 2022 and became operational in the March 2023 quarter.

4 Red Chris

Overview

The Red Chris mining operation is located in northwest British Columbia, Canada, approximately 1,700km north of Vancouver and 18km southeast of the town of Iskut (at an elevation of approximately 1,500m). The land tenures for the mining operation are located within the territory of the Tahltan Nation and sit across the Red Chris main claim group and the Red Chris south group. They collectively comprise 80 mineral tenures and covers more than 230km².

The following map shows the location of the Red Chris mining operation and exploration tenements:

RED CHRIS – ILLUSTRATIVE MAP OF PROJECT AREA

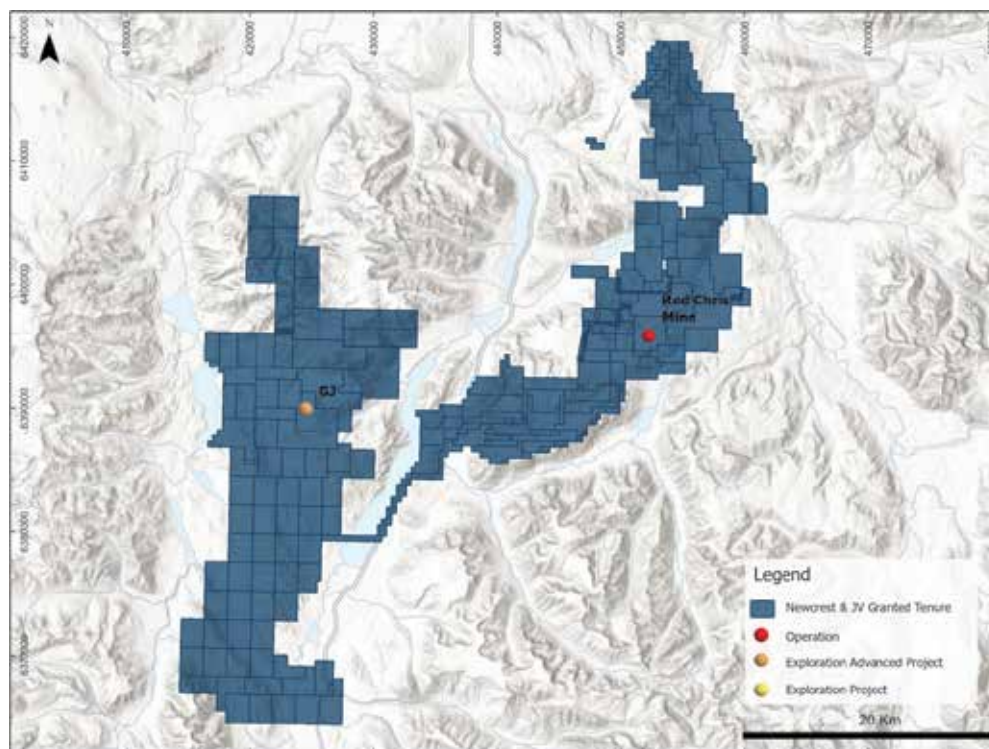

Source: Newcrest

GRANT SAMUEL



Red Chris is Newcrest's first major foothold in North America. Exploration in the Red Chris project area dates back to 1956 when copper mineralisation was first discovered in the area. Over the following decades, a number of junior mineral explorers undertook further geological mapping, sampling, surveys, drilling and other studies to assess the potential mineralisation. These studies led to the discovery of near surface copper-gold mineralisation in the mid-1990s. Following further deep drilling and the update of a previous feasibility study prepared by Imperial Metals Corporation ("Imperial"), construction of the open pit mine commenced in 2012 and was completed in 2014 with first production in 2015. Over the next four years, Red Chris (then under 100% Imperial ownership) produced approximately 130kt of copper and 150koz of gold. Red Chris is essentially a copper mine with material gold by-product revenue. Over FY20-22, copper presented approximately 70% of revenue. In 2019, Newcrest acquired a 70% joint venture interest in the Red Chris mining operation and assumed operatorship of the mine (including sales and marketing of the copper-gold concentrates) and surrounding mineral tenements.

Today, Red Chris is still an open pit mining operation but with a limited life (closure of the pit is planned for FY26). ROM ore is processed via conventional grinding and flotation methods to produce copper-gold concentrates with a grade of 23-24% copper and 10-15g/t gold. The resulting concentrate product is trucked to the Port of Stewart for storage before being loaded onto vessels for export. While the Red Chris concentrate product is considered slightly below premium-grade copper concentrates, a large market for these products exists in China (in contrast to Newcrest's other target markets that sell into other north Asian markets such as Japan and South Korea).

As part of the announcement of the Red Chris transaction, Newcrest revealed that it believed that the orebody had the potential to become a high margin bulk underground block cave with an economic life of over 30 years (and potentially over 50 years). Accordingly, Newcrest accelerated the necessary drilling and studies, meeting major milestones including:

- commencement of construction of the box cut for the exploration decline (February 2021);
- announcement of the initial mineral resource estimate (March 2021); and
- completion of the pre-feasibility study for the block cave development (October 2021).

The pre-feasibility reconfirmed the significant potential value to be unlocked from the block cave expansion, highlighting that the block cave would extend mine life (from around 3-4 years to well over 30 years) and unlock over 8.1Moz of gold and 2.2Mt of copper in ore reserves. Copper is expected to still represent approximately 60% of revenue.

The expansion would be developed as a series of block caves, with Macro Block 1 ("MB1") the first to be developed and commissioned by FY26. The feasibility study continues to be progressed by Newcrest and is expected to be completed later in CY23. FID on the project remains subject to the findings of the feasibility study and approval by the Newcrest Board.

Red Chris has a workforce of approximately 600 (including contractors). All employees are housed on site on a two-weeks on, two-weeks off roster.

As the mining operations are located entirely within the Tahltan Nation's territory, the Red Chris mining operation is subject to a revenue sharing arrangement that is paid annually. A separate royalty is payable to International Royalty Corporation, a subsidiary of Royal Gold Inc.

Based on the data published by the World Gold Council², Red Chris is positioned towards the top end of cost curve for gold producers primarily due to the recent step-up in sustaining capital expenditures. Following the completion of the block cave expansion, Red Chris is expected to be positioned favourably along the global gold cost curve due to the low ongoing operating costs for block cave mines and substantial copper by-product credits (more than 50% of revenue).

GRANT SAMUEL



Geology and Mineralisation

The Red Chris deposit is located within the Golden Triangle, named for the rich gold orebodies it hosts as well as the abundant silver, nickel and copper deposits within the area. The mineral deposits in the Golden Triangle are generally found within depths of 2,000-2,500m.

The Red Chris deposit is a porphyry copper-gold deposit that has been described as having similar characteristics to the mineral endowment in Cadia. In broad terms, it is an abundant but low grade orebody. The deposit spans approximately 3,400m in strike length, 300m in width and over 1,300m in depth. The strike length of the deposit can be broadly split into two separate zones of similar lengths and depths — the Main Zone and East Zone. The two zones are separated by an area known as the Saddle Zone, which is less well mineralised.

Copper mineralisation occurs as copper sulphide minerals that are contained within thin wavy or thicker planar quartz veins (but can also be found disseminated outside the veins). Gold mineralisation typically occurs within the copper sulphides but occasionally also as free grains in high grade zones.

East Ridge is a recently discovered area of high grade porphyry style mineralisation that is located around 300m east of the East Zone. Recent drilling has identified a mineralisation corridor that is approximately 1,000m long, 450m wide and across a vertical extent of 1,000m, with localised areas containing high grade potential (greater than 1 g/t gold and 1.0% copper). Mineralisation remains open at depth. The exploration target defined for East Ridge is reported to be approximately 400-500Mt, with average grades around 0.4 g/t of gold and 0.5% of copper.

The GJ Project hosts separate porphyry-style mineralisation and is located adjacent to the Red Chris mining operation, covering 967km² of land. Drilling to define the extent of the mineralisation is ongoing.

Mining

CURRENT OPERATIONS

The Red Chris open pit mine currently uses conventional mining methods via a truck and shovel fleet to produce between 10-11Mtpa of ore per annum. Drill and blast of ore and waste is undertaken using rotary blasthole drills. Pit walls may be drilled with a pre-split (i.e. controlled blasting techniques) to protect stable rock conditions. ROM material is handled by electric hydraulic shovels which load the material onto 230t capacity haul trucks from 12m benches for transport to either the mill crusher at the processing plant or low-grade stockpiles (or in the case of waste rock, to the on-site waste rock storage facilities).

Mining of the open pit is conducted by Newcrest. It is phased into individual mineable pushbacks (each called a phase) across both the Main Zone and East Zone. The Red Chris open pit mine was originally commissioned to have eleven distinct phases. The open pit deposits have been largely exhausted and only two pit phases remain — Phase 7 in the Main Zone and Phase 5R in the East Zone. Accordingly, the open pit mine has a limited remaining mine life and is expected to cease mining operations in FY26.

BLOCK CAVE EXPANSION

The block cave mining operation will sit below the existing open pit mining operation and target the East Zone resource at depth. The block cave mine will comprise three adjoining macro mining blocks that would be mined sequentially:

GRANT SAMUEL



RED CHRIS – INDICATIVE BLOCK CAVE MINE LAYOUT

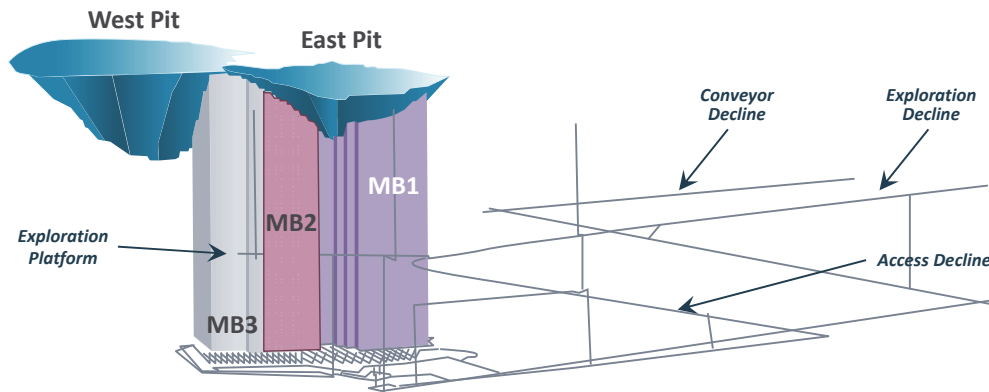

Source: Newcrest.

Note: Positioning of MB2 has been added for illustrative purposes only.

The planned mining sequence is based on the copper and gold grades of each mining block as well as other geotechnical conditions:

- MB1 will be operational between FY27 and FY41 at a mining rate of up to 15Mtpa (but at declining rates after FY36). This mining block is the first to be mined due to the size of its reserves and high grades (average gold grade of approximately 0.77g/t and copper grades of approximately 0.59%, excluding development ore);
- MB2 will be operational between FY36 and FY48 at a mining rate of up to 7Mtpa. While this mining block is substantially smaller than the other two mine blocks and has markedly lower grades (around 0.41 g/t gold and 0.37% copper, excluding development ore), it is the southern extension of MB1 and must be opened before the higher grade MB3 area can be accessed. It will also have lower development capital; and
- MB3 will be operational between FY41 and FY57 at a mining rate of up to 15Mtpa. Copper and gold grades within this mining block are lower than at MB1 but similar to MB2.

The Red Chris underground resource will extend to a depth of 1,200m below the surface. The average heights of the mining blocks will differ depending on the sequence but will broadly be around 50-600m in height (and up to around 800m max). Each mining block will comprise its own undercut level (where a targeted area of the orebody is subjected to drill and blasting to allow the orebody to “cave”) and an extraction level (approximately 25m below the undercut level where ore is recovered). Load haul dump machines will be used to mine and recover the ore and transport it to a single crushing station (located close to MB1) that will service all mining blocks. Crushed ore will then be transferred to the decline conveyor and transported to the surface, where it will be loaded onto stockpiles.

Development of the block caves is a significant task that will demand substantial capital commitments. As the first cave to be developed, MB1 will be the most expensive and, based on pre-feasibility study estimates, is expected to require nearly C\$2 billion (around \$1.5 billion based on current exchange rates) in upfront capital. Developing the MB2 and MB3 extensions are expected to require markedly less capital.

Underground development works are contracted to Barminco, a division of Perenti Limited, which is responsible for the development of the exploration decline (i.e. the first stage of works to install an exploration platform from which underground exploration activities can be used to support future block cave workings). The incline currently extends to approximately 3km.

Annexure 1. Independent Expert's Report

GRANT SAMUEL



EAST RIDGE EXPANSION

East Ridge mineralisation is not included in the current mine design contemplated in the block cave feasibility study but is expected to provide Newcrest with future optionality on mine sequencing.

Mine designs and studies at East Ridge remain at an early stage. However, early studies indicate the potential for future block caves that can leverage existing mine infrastructure constructed as part of the Red Chris block cave expansion. Due to its standalone nature, East Ridge represents additional mining optionality at Red Chris.

The scale of the new block caves is expected to be substantial and comparable to the orebodies targeted in the Red Chris block cave expansion. Capital costs will be higher because of East Ridge's greater depth. The updated exploration target is supportive of a ~20 year extension to the mine life at Red Chris (assuming similar mining rates as the block cave) and higher grades than in MB2 (potentially allowing for East Ridge to be mined ahead of MB2 and MB3 in the mine plan).

Processing

Red Chris operates a single process flowsheet that consists of a SAG mill, ball mill and pebble crushing circuit that sequentially feeds into a two-stage flotation circuit. Nominal processing capacity is approximately 11Mtpa. As part of the block cave expansion, the process plant will also need to be upgraded to accommodate the higher head grade and hardness of the underground ore as well as the increased throughput rates from the mine. Newcrest is currently considering upgrading the plant capacity to either:

- 13.6Mtpa, which will largely keep the existing process but will add a new parallel grinding line to meet the higher throughput. The grinding-flotation methods will mirror the existing grinding line; or
- 15Mtpa, which will be an extension of the 13.6Mtpa option and will also incorporate coarse ore flotation technologies to accommodate a wider variation in grind sizes and a higher throughput rate.

Newcrest is also reviewing alternative staged options that do not require a brand new parallel grinding line (and thereby will involve less upfront capital).

Tailings from the processing plant are segregated and disposed separately. One tailings stream is considered to be "clean" material and can be repurposed as construction material for the tailings dam and other infrastructure. The other tailings stream contains higher sulphide content and consequently needs to be disposed in the tailings impoundment area. Current capacity at the tailings impoundment area is 302Mt and will need to be expanded to 550Mt to support the proposed block cave expansion.

Resources and Reserves

Reported mineral resources (100% basis) at Red Chris are summarised below:

RED CHRIS – MINERAL RESOURCES AT 30 JUNE 2023 (100% BASIS)³

	MEASURED			INDICATED			INFERRED			TOTAL VOLUMES		
	Ore (Mt)	GRADE		Ore (Mt)	GRADE		Ore (Mt)	GRADE		Ore (Mt)	Au (Moz)	Cu (Mt)
		Au (g/t)	Cu (%)		Au (g/t)	Cu (%)		Au (g/t)	Cu (%)			
Red Chris Open Pit	-	-	-	220	0.31	0.37	8	0.26	0.31	228	2.3	0.8
Red Chris Open Pit Stockpiles	9	0.17	0.25	-	-	-	-	-	-	9	0.0	0.0
Red Chris Underground	-	-	-	670	0.46	0.40	180	0.32	0.30	850	11.8	3.2
Total										1,086	14.1	4.0

Source: Newcrest and Grant Samuel analysis

Reported ore reserves (100% basis) at Red Chris are summarised below:

GRANT SAMUEL

RED CHRIS – ORE RESERVES AT 30 JUNE 2023 (100% BASIS)³

	PROVED			PROBABLE			TOTAL VOLUMES		
	Ore (Mt)	GRADE		Ore (Mt)	GRADE		Ore (Mt)	Au (Moz)	Cu (Mt)
		Au (g/t)	Cu (%)		Au (g/t)	Cu (%)			
Red Chris Open Pit	-	-	-	42	0.40	0.47	42	0.5	0.2
Red Chris Open Pit Stockpiles	-	-	-	8	0.16	0.24	8	0.0	0.0
Red Chris Underground	-	-	-	410	0.55	0.45	410	7.2	1.8
Total							460	7.8	2.0

Source: Newcrest and Grant Samuel analysis

The vast majority of Red Chris' mineral resources and ore reserves is located within the Red Chris underground deposit, which contains higher grades of gold but similar grades of copper as the currently operating open pit mine. The resource estimates have been categorised into three zones reflecting the separate mining areas following the block cave expansion:

- MB1, which represents approximately 38% of underground ore reserves;
- MB2, which is the smallest zone of mineralisation (less than 20% of underground ore reserves) and hosts the lowest grades of copper and gold mineralisation; and
- MB3, which is the largest zone of mineralisation and accounts for more than 40% of underground ore reserves.

Mineral resources are estimated on the basis of a cut-off criteria of C\$21/t NSR. This establishes a depth cut-off of 1,200m below the surface which is the lowest level that can be reasonably extracted by block caving given Newcrest's current understanding of the orebody. Ore reserves are estimated using a higher cut-off grade of C\$22-22.8/t NSR. The variable cut-off grade reflects the different breakeven costs for each of the block caves (i.e. MB1 being the lowest cut-off and MB3 being the highest).

The remaining mineral resources and ore reserves are attributable to the open pit and low-grade stockpiles. Due to the lower ongoing operating and capital costs required for the open pit operation (and even moreso for the stockpiles), the cut-off criteria for mineral resources and ore reserves are lower than for the underground mine (at approximately C\$17.70/t NSR and C\$20.33/t NSR, respectively).

No mineral resources have been declared for the East Ridge and GJ Project exploration targets. However, East Ridge mineral resources are expected to be announced later in CY23 incorporated within a holistic resource update for Red Chris. All of the necessary drilling has been undertaken with a series of procedural steps to be completed prior to its release. At this stage, Newcrest has identified an exploration target estimate that indicates a range of 400-500Mt of ore containing 5.4-6.1Moz of gold and 1.9-2.3Mt of copper.

At the time of the Red Chris transaction, Imperial reported approximately 1,700Mt of total resources containing approximately 20Moz of gold and 5.9Mt of copper⁶. Newcrest subsequently undertook an extensive work program to define the potential of a block cave mine beneath the existing open pit operation. Additional exploration and resource definition drilling as well as resource optimisation were completed to reassess the resource's potential (and to restate it to be compliant with the JORC Code).

Upon completing the work program, Newcrest announced an initial mineral resource and ore reserve estimate for Red Chris (excluding East Ridge), recognising the potential of the large underground resource base (which accounted for more than 70% of mineral resources and over 80% of ore reserves). Since the announcement, movements in the Red Chris mineral resources have generally been caused by mining depletion at the open pit mine as well as movements in stockpile ore.

⁶ Reported under Canadian Institute of Mining, Metallurgy and Petroleum ("CIM") Definition Standards which may have slight differences to the JORC Code.

Annexure 1. Independent Expert's Report

GRANT SAMUEL



The following chart shows the movements in mineral resources and ore reserves at Red Chris in recent years:



Operating Performance

The operating performance of Red Chris for FY20 to FY23 is summarised below:

RED CHRIS - OPERATING PERFORMANCE (70% BASIS)

	FY20 ⁷ ACTUAL	FY21 ACTUAL	FY22 ACTUAL	FY23 ACTUAL
Total production				
Total material mined (kt)	19,331	23,861	24,529	21,761
Total ore treated (kt)	5,847	6,733	6,488	6,513
Total gold produced (koz)	39	46	42	39
Total copper produced (kt)	25	23	21	18
Head grade				
Gold (g/t)	0.39	0.39	0.35	0.36
Copper (%)	0.54	0.44	0.42	0.37
Financial metrics				
EBITDA (\$ millions)	63	79	98	(5)
AISC (\$/oz)	1,703	2,248	1,349	3,733
Capital expenditure (\$ millions)	64	127	203	170
Revenue split				
% of revenue from gold	30%	32%	27%	32%
% of revenue from copper	70%	68%	73%	68%

Source: Newcrest and Grant Samuel analysis

The operating performance of Red Chris reflects the continued depletion of ore reserves at the open pit. While ore treatment rates (on a 100% basis) have consistently been around 9-9.5Mtpa, gold and copper production have trended downwards in each of the years as higher grade ore in the open pit deposits have been exhausted. Copper grades have already seen a steep decline from 0.54% in FY20 to 0.37% in FY23.

⁷ FY20 does not reflect a full year of operating performance and as Newcrest began reporting production results from the acquisition completion date (15 August 2019).

GRANT SAMUEL



Gold grades are expected to remain low following the completion of mining at Phase 5 in the first half of FY23 and the transition to lower grade areas in Phase 7 and Phase 8.

Productivity was further impacted by seasonal extreme weather events typical for the region, causing outages, adverse road conditions and freezing of key infrastructure (e.g. the tailings line in FY22). Unplanned downtimes of processing infrastructure (e.g. the SAG mill in FY22 and the rock breaker failure in FY23) have also introduced new issues that have crimped productivity and impacted unit costs.

As a result of these issues, Newcrest has invested in a number of operational improvement initiatives across the Red Chris mining and processing operations including:

- a safety transformation program, focusing on safety culture, controls and processes that has delivered improvements in total recordable injury rates (FY20 and ongoing);
- new fleet management systems, which can optimise haul routes and improve fleet availability (FY21);
- implementation of a pre-crusher blending program to optimise mill feed (FY22); and
- expansion of the cleaner column to improve the quality of water used in the milling process (FY23).

While rising copper prices have provided some relief to Red Chris' cost position (by way of by-product credits) in each of the years (particularly FY22), elevated levels of capital investment (e.g. the ongoing pre-production stripping program) have pushed AISC up further (especially in FY21 and FY23). FY21 AISC was also impacted by unusually high rainfall and higher site operating costs.

The future block caving operation is integral to the future of the Red Chris mining operation. The material reductions in future operating unit costs due to the step change in mining throughput rates are collectively expected to support Red Chris' expected transition to one of the lowest cost gold producers globally.

5 Brucejack

Overview

Brucejack is one of the highest grade operating gold mines in the world⁸. It is located within the Golden Triangle region of British Columbia, approximately 140km southwest of the Red Chris mine. Mining operations are located at the top of the Knipple Glacier (elevation approximately 1,500m) The following map shows the location of the Brucejack mining operation (including exploration tenements) which covers 1,240 km² (across four mining leases and nearly 350 mineral claims):

⁸ Source: Newcrest's ASX market release dated 9 March 2022, "Newcrest completes acquisition of Pretium Resources"

Annexure 1. Independent Expert's Report

GRANT SAMUEL



BRUCEJACK – ILLUSTRATIVE MAP OF PROJECT AREA

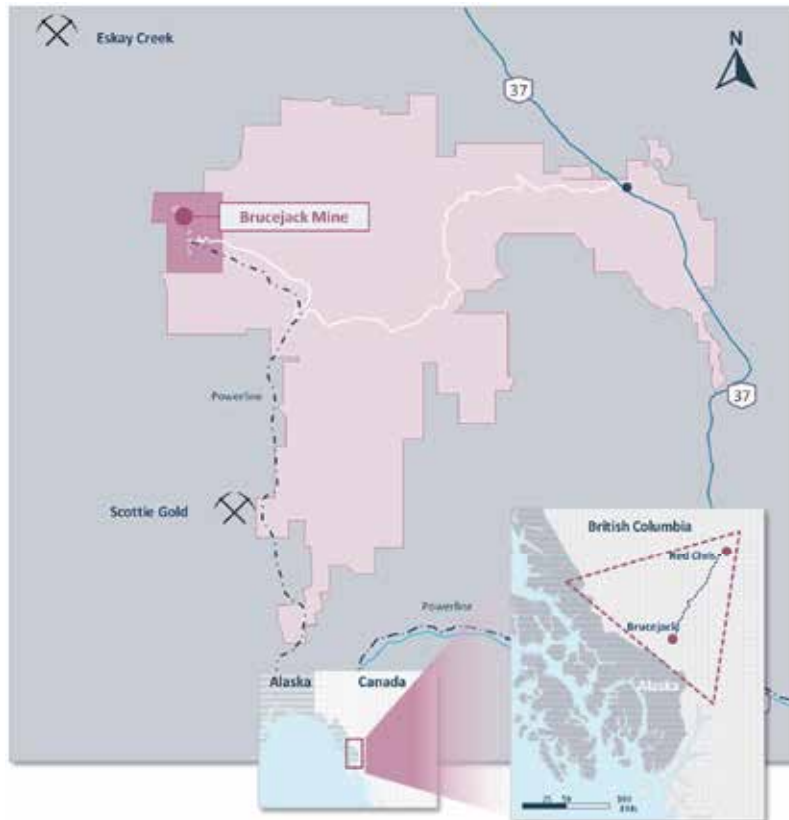

Source: Newcrest

The earliest known prospecting in the Brucejack region dates back to the 1880s but it was not until 1935 that copper-molybdenum mineralisation was discovered. Over the next two decades, prospecting in the area was relatively sporadic, with a number of different junior prospectors uncovering smaller copper and gold-silver mineralisation. Modern exploration in the area began in the 1960s and accelerated over the following decades. In 2009, gold mineralisation was discovered in the Valley of the Kings Zone following which subsequent drilling programs focused on defining the corridors of high-grade mineralisation. In 2010, Pretivm acquired 100% of the exploration tenements and subsequently advanced development studies, including completing a feasibility study for a potential underground mine. Construction of the mine commenced in 2015 and was completed in 2017, with commercial production commencing shortly thereafter. Production ramped up over the following years before Brucejack was acquired by Newcrest in 2022 as part of the Pretivm transaction.

Today, Brucejack is an underground mining operation producing over 300koz of gold per annum and 400koz of silver per annum. The mine has a total workforce of approximately 1,200 people (including seasonal requirements). Mining operations are conducted by a third party mining contractor (Procon Mining & Tunnelling Ltd (“Procon”)) with Newcrest managing all other operations (including ore processing, exploration, site management, accommodation and administration) as well as mine planning and technical services. Newcrest plans to progressively take mine production “in house” so as to improve flexibility with Procon to transition to a focus on mine development. Mining is undertaken via long-haul open stoping mining methods with mined stopes backfilled with paste. Mined ore is transported to the surface to undergo conventional gravity concentration and flotation processes. The two-stage treatment process

GRANT SAMUEL



produces gold-silver doré (approximately 60% gold and 35% silver) and gold-silver concentrate (typically around 45-60 g/t gold and around 115 g/t silver). The gold-silver doré is air shipped to precious metal refineries in Australia and Switzerland, while the concentrate is hauled by truck to Port of Stewart where it is then loaded onto vessels for export to two customers in Asia.

Since the acquisition, Newcrest has undertaken a number of initiatives to transform the Brucejack operations. They include implementing mine equipment tracking and monitoring capabilities, adopting semi-autonomous and autonomous technologies and improving ore blending strategies. A debottlenecking study to unlock a 20-30% uplift in throughput by 2025 is currently underway. An external spending review was also launched to leverage any synergy benefits with Red Chris (targeting the consolidation of major contracts, reducing non-critical purchasing and boosting contractor productivity). In addition, ore sorting (to deliver more consistent mill feed grades and potentially reduce operating costs and cut-off grades) has been successfully trialed and is subject to further investigation. The most material of these initiatives is arguably the near-mine and district-scale exploration opportunities to add to the existing ore reserve inventory. Following the initial release of mineral resources and ore reserve statement, Newcrest is continuing an extensive drilling program to improve grade estimation in Brucejack and progress the resource development across a number of targets that, if successful, would extend the project life (or spur a redesign of the mine plan).

Brucejack has a total workforce (including contractors) of approximately 900. The site operates on a two weeks on, two weeks off basis.

Brucejack is subject to a number of ongoing third party agreements, including a revenue sharing agreement and a cooperation and impacts benefits agreement (which sets certain financial compensation payments as project milestones are reached) with traditional landowners. A separate mineral royalty is paid to Franco-Nevada Corporation.

Based on the data published by the World Gold Council², Brucejack is positioned towards the middle of the cost curve, with the high gold grades of its ore reserves offset by its relatively high operating costs.

Geology and Mineralisation

The Brucejack deposit is located within the Golden Triangle and embodies the rich gold and abundant silver endowments of the orebodies found in the region. Mineral resources are reported from within two main areas of mineralisation:

- the Valley of the Kings Zone, which is currently defined over 1,200m in east-west extent, 700m in north-south extent, and 650m in depth. The deposit remains open at depth (the 1080 HBX Level), to the south (the Bridge Zone) and the west (North Block); and
- the West Zone, which is located north of the Valley of the Kings Zone and spans 590m along its northwest strike and 560m across strike at similar depths to the Valley of the Kings Zone.

While there are some differences between the mineralisation that occurs between the two zones, the deposit can generally be characterised as epithermal and contained in sub-vertical vein and stockwork as well as vein breccia systems (i.e. rock that is shaped by angular fragments that have been bound together by a mineral cement and other particles). However, the geology is complex and variable with very high concentrations of gold found in small pockets.

Other mineralisation zones have also been identified within the Brucejack tenements and extend along a 4km trend north of the Valley of the Kings Zone and West Zone (including Gossan Hill and Golden Marmot). Newcrest has also identified other areas of interest further afield (e.g. American Creek). Drilling to define the extent of the mineralisation along this area is ongoing.

GRANT SAMUEL



Mining

Underground mining at Brucejack is by long-hole open stoping methods which broadly involves:

- levels development, where sub-levels are developed at vertical intervals throughout the orebody;
- drill and blasting, which “releases” ore from the orebody;
- haulage of ore from the ore base to a centrally located underground crusher located close to the Valley of the Kings Zone; and
- transport of crushed ore to surface via main decline conveyor to be fed into the mill feed conveyor.

Current mining operations are focused on both the Valley of the Kings Zone and West Zone. The mine design predominantly comprises transverse longhole stopes (where the stope is built perpendicular to the strike of the orebody). Longitudinal stoping (where stopes are built parallel to the orebody) is also selectively used across the orebody.

Mining of the orebody can be divided into six separate blocks from which multiple mining fronts can occur in parallel. Each block will have its own set of primary stopes and secondary stopes. The mining sequence begins with the extraction of the primary stopes on the first (lowest) level and progresses upwards towards the top. The primary stopes towards the middle of any given level are typically mined first in order to protect the redistribution of ground stress. Mining of the secondary stopes commences only after the primary stopes of the levels above have been completed. Collectively, mining of these multiple blocks and mining fronts has supported a mine production rate of up to 3,800t per day (or around 1.3Mtpa).

Mine development will unavoidably produce waste rock on an ongoing basis. Development waste is used as backfill where permissible (e.g. secondary stopes below 1,350m in depth). The remainder is transported to the surface and disposed of in the Brucejack Lake.

Processing

The processing flowsheet at Brucejack begins with the receipt of mill feed (i.e. crushed ore transported from the underground primary crushing facility). The mill feed is fed into the primary grinding circuit, where the crushed ore is subjected to further grinding by a SAG mill and reduced further into pulp (or re-ground via the pebble crusher if the SAG mill discharge is oversized).

Once the pulp from the primary grinding circuit is sufficiently homogenous in size and/or shape, it is fed into a cyclone which separates the feed into two separate streams:

- the overflow stream, which feeds into a bulk gravity concentration process to recover high-grade gold metals. This stream sends the pulp from the grinding circuit into a semi autogenous ball mill crusher grinding circuit which is incorporated with two centrifugal gravity concentrators to recover gold and silver nugget grains that are liberated from their host minerals. The gravity concentrate is then directly smelted to produce gold-silver doré (which accounts for two-thirds of gold production); and
- the underflow stream, which feeds into a conventional flotation process to recover the gold and silver metals. The pulp is subjected to two stages of rougher and scavenger flotation and three stages of cleaning (i.e. thickening and filtration) to produce final gold-silver concentrates (which accounts for one-third of gold production).

In aggregate, the Brucejack processing plant has total throughput capacity of 3,800tpd (matching the mine's ore production rate) but is currently operating at over 4,000tpd as a result of various initiatives.

Tailings are pumped to a cone thickener where most of the water is removed and the thickened tailings is either pumped to the paste backfill feed tank (for underground mine backfilling) or pumped to Brucejack Lake for storage.

GRANT SAMUEL



Production Uplift

Newcrest plans to increase production to approximately 5,000 tpd (1.8Mtpa) by 2025 through debottlenecking various elements of the mining and processing operations.

For mining, the focus is on:

- increasing the number of mining fronts (requiring more people and equipment but potentially aided by increasing operating hours);
- changing mining methods (e.g. the planning and drilling process) to create larger contiguous stopes (facilitated by the enhanced flexibility of the shift to in-house production); and
- upgrading electrical and ventilation systems.

For processing, the plan involves:

- increase coarse ore processing capacity;
- installing an additional Knelson concentrator;
- additional filtration for dewatering; and
- installing additional flotation cells.

If the ore sorting project is successfully implemented, the production plan (particularly for the processing plant) could be further refined.

Resources and Reserves

On 11 August 2023, Newcrest announced revised resource and reserve estimates in accordance with the JORC Code and using different methodologies to those previously adopted by Pretium.

Reported mineral resources at Brucejack are summarised below:

BRUCEJACK – MINERAL RESOURCES AT 30 JUNE 2023³

	MEASURED				INDICATED				INFERRED				TOTAL VOLUMES			
	GRADE				GRADE				GRADE				Ore (Mt)	Au (Moz)	Cu (Mt)	Ag (Moz)
	Ore (Mt)	Au (g/t)	Cu (%)	Ag (g/t)	Ore (Mt)	Au (g/t)	Cu (%)	Ag (g/t)	Ore (Mt)	Au (g/t)	Cu (%)	Ag (g/t)				
Brucejack	-	-	-	-	19	13	-	34	10	13	-	13	29	12.2	-	25.1

³Source: Newcrest and Grant Samuel analysis

Reported ore reserves at Brucejack are summarised below:

BRUCEJACK – ORE RESERVES AT 30 JUNE 2023³

	PROVED				PROBABLE				TOTAL VOLUMES			
	GRADE				GRADE				Ore (Mt)	Au (Moz)	Cu (Mt)	Ag (Moz)
	Ore (Mt)	Au (g/t)	Cu (%)	Ag (g/t)	Ore (Mt)	Au (g/t)	Cu (%)	Ag (g/t)				
Brucejack	-	-	-	-	14	8.4	-	32	14	3.7	-	14

³Source: Newcrest and Grant Samuel analysis

The vast majority of the mineral resource and ore reserves were found in the Valley of the Kings deposit. Economic levels of silver metals were also present in the ore reserves and mineral resource.

Operating Performance

The operating performance of Brucejack is difficult to present on a consistent basis. Newcrest began consolidating Brucejack's operating results following completion of the transaction on 9 March 2022 (with

Annexure 1. Independent Expert's Report

GRANT SAMUEL



limited disclosures on the two preceding quarters). The latest available information published by Pretium reported operating performance only through 30 September 2022 (albeit on a calendar year basis). There are gaps in the reported information and inconsistencies between the year-to-year reported figures (e.g. comparing CY to FY performance).

Accordingly, an assessment of its operating performance requires a longer term view of the mine. The operating performance of Brucejack since its inception in CY17 is summarised below:

BRUCEJACK - OPERATING PERFORMANCE SINCE INCEPTION

	CALENDAR YEAR BASIS					FISCAL YEAR BASIS	
	CY17 ACTUAL 12 MONTHS	CY18 ACTUAL 12 MONTHS	CY19 ACTUAL 12 MONTHS	CY20 ACTUAL 12 MONTHS	CY21 PROFORMA 12 MONTHS ⁹	FY22 PROFORMA 12 MONTHS ¹⁰	FY23 ACTUAL 12 MONTHS
<i>Total production</i>							
Total material mined (kt)							2,053
Total ore treated (kt)	533	1,006	1,303	1,307			1,351
Total gold produced (koz)	152	376	354	348	351	335	286
Total silver produced (koz)	179	423	517	472			460
<i>Head grade</i>							
Gold (g/t)	9.40	11.90	8.70	8.50	8.06 - 8.40	6.93 - 8.07	6.82
<i>Financial metrics</i>							
EBITDA (\$ millions)	60	202	215	317			220
AISC (\$/oz)	852	764	888	981	1,059 - 1,182	1,071 - 1,510	1,157
Capital expenditure (\$ millions)	375	33	44	49			81
<i>Revenue split</i>							
% of revenue from gold	100%	100%	100%	100%	100%	100%	100%
% of revenue from copper	--	--	--	--	--	--	--

Source: Pretium, Newcrest and Grant Samuel analysis

Since its inception, Brucejack has demonstrated stable operating performance, with annual gold production of approximately 330-350koz per annum (peaking at 376koz of gold in CY18). Mill rates have remained broadly steady at or close to nameplate capacity since the initial ramp-up period. Year-to-year movements in gold production have been largely attributable to changes in head grades (which peaked in CY18 at nearly 12 g/t gold) as mine production first exhausted higher grade areas of the ore reserves and then progressed towards lower grade areas (albeit still at substantially higher grades than Newcrest's other mineral assets).

The increase in the cash costs (measured in AISC) since the Pretium acquisition reflects the upfront capital expenditures incurred by Newcrest as it undertook a major transformation program across the Brucejack mining operation. AISC was impacted further in FY23 when a critical incident in October 2022 resulted in a three-week suspension of mining and processing operations (also affecting production and EBITDA).

⁹ Based on nine months of operating results as reported by Pretium (1 January 2021 to 30 September 2021) and three months of operating information has reported by Newcrest (1 October 2021 to 31 December 2021).

¹⁰ Based on three months of operating results as presented by Pretium (1 June 2021 to 30 September 2021) and nine months of operating information has reported by Newcrest (1 October 2021 to 30 June 2022).

GRANT SAMUEL



6 Wafi-Golpu

Overview

The Wafi-Golpu project is located approximately 65km southwest of the city of Lae, in the Morobe Province of Papua New Guinea. It is Newcrest's most advanced greenfield development project and is currently in the permitting phase. The project comprises three separate mineral deposits that sit across two exploration licences covering approximately 129km² of mountainous terrain.

The following map shows the location of the Wafi-Golpu project:

WAFI-GOLPU – ILLUSTRATIVE MAP OF PROJECT AREA



Source: Newcrest

The project area had been the subject of exploration activities (e.g. sampling and surveying) since the 1970s. The Wafi deposit was first discovered in 1983, with the Golpu deposit identified in 1990. In 2008, subsidiaries of Newcrest and Harmony Gold Mining Company Limited (at that time the sole owner of the project) established the 50:50 Wafi-Golpu Joint Venture over the exploration licences that host the Wafi-Golpu deposits.

In Papua New Guinea, developing a major mining operation involves an extensive permitting regime under the *Mining Act 1992 (PNG)* that culminates in the granting of a Special Mining Lease by the State of PNG. The permitting process involves the completion of the following prerequisites:

- Grant of an Environmental Permit under the Environment Act 2000 (PNG), which requires the submission of a detailed environmental impact study followed by a public notification and review;
- Mining Development Contract, which outlines fiscal and regulatory arrangements for the project (e.g. including term and scope of the Special Mining Lease, project implementation, infrastructure, rates and duties);
- Convening of a development forum by the Minister for Mining under section 3 of the Mining Act 1992 (PNG) to consider the views of those persons whom the Minister believes will be affected by the grant of the special mining lease. The intended outcome of the forum is a Memorandum of Agreement

Annexure 1. Independent Expert's Report

GRANT SAMUEL



dealing with matters such as the basis on which benefits from the project (such as royalties) will be distributed;

The State of PNG retains the right to purchase, at a pro rata share of accumulated exploration expenditure, up to 30% equity interest in any mineral discovery at Wafi-Golpu, at any time before the commencement of mining. If the State of PNG chooses to take-up its full 30% interest, the interest of each of Newcrest and Harmony will become 35%.

The Wafi-Golpu joint venture has achieved the following milestones focusing on proposed development of the Golpu deposit:

- in 2012, the completion of a pre-feasibility study which was subsequently updated in 2014 to include certain modifications to optimise the proposed mine plan;
- in 2016, the completion of a feasibility study and submission of a Special Mining Lease application to the Papua New Guinea Mineral Resources Authority;
- in 2018, the completion of an updated feasibility study for the \$2.8 billion greenfield development. The Special Mining Lease application was amended and updated;
- in 2020, the granting of an Environment Permit under the PNG Environment Act (which was subsequently challenged by the then Governor of Morobe Province in March 2021 although the new Governor that was elected in 2022 has indicated he will withdraw the court cases); and
- in 2023, signing of the Wafi-Golpu Framework Memorandum of Understanding (MoU) which sets out key terms to be included in the Mining Development Contract, including in relation to state equity participation, fiscal terms, stability and social development commitments.

The parties are now negotiating the detailed terms of a Mining Development Contract, which is a prerequisite for the granting of a Special Mining Lease (SML). Once an SML is granted the Wafi-Golpu Joint Venture intends to then update the 2018 feasibility study and commence engineering towards development.

Geology and Mineralisation

The Wafi-Golpu deposits are part of a complex mineralised system which are considered by Newcrest to be representative of different mineralisation models including copper-gold porphyry style deposits and epithermal gold deposits. The deposits include:

- Golpu, which is a copper-gold porphyry style deposit that extends over 800m north-south by 500m west-east and has been drill tested to a depth of more than 2,000m (with the orebody remaining open at depth). The highest grades of mineralisation (primarily gold, copper and silver) occur towards the core of the porphyry;
- Wafi, which is an epithermal gold deposit that sits closer to the surface above the upper portions of the Golpu deposit. Much of the mineralisation is refractory; and
- Nambonga, which is a low-grade copper-gold porphyry style mineralised system. Mineralisation primarily occurs as copper sulphides (in the form of chalcopyrite) found in veins.

Mining

The Wafi-Golpu project is expected to be developed into an underground block cave mining operation designed to produce up to 17Mtpa of ore over 28 years. Mining will progress through a series of block caves that target the high grade Golpu deposit.

During caving operations, ore from the block cave drawpoints is planned to be delivered by autonomous load-haul-dump vehicles to underground crushers. The proposed Material Handling System includes two



GRANT SAMUEL



crushers on each level, from which the crushed ore is to be conveyed to the surface via dedicated transfer conveyors. The ore conveyor emerging at the portal terrace on the surface will continue overland to deliver crushed ore to a coarse ore stockpile adjacent to the Watut Process Plant.

Due to high surface ambient temperatures and humidity, and the depth of the mine, considerable ventilation and cooling capacity (i.e. bulk air cooling facilities) is expected to be installed to ensure the health and safety of mine workers.

The tropical climate requires the mine to withstand heavy rainfall events. The mine dewatering designs include the dewatering from the block caves to surface using a cascade pumping system. Emergency dewatering in the case of extreme rainfall entering the cave through the subsidence zone is also catered for. The extraction level is sloped away from the crusher chambers to provide emergency surge storage capacity. In addition, all pump stations and electrical equipment associated with dewatering are installed above the flood line, to ensure mine dewatering can still be achieved during and after a flood event.

The 2018 updated feasibility study does not contemplate the mining of any ore from the Wafi or Nambonga deposits. Further work is required to better define and understand these orebodies.

Processing

The proposed Watut processing plant will be a copper concentrator that will initially be designed to use conventional crushing, grinding and flotation methods. The facility will comprise a semi-autogenous grinding mill, two ball mills and a recycle crushing configuration, flotation, thickening, concentrate pumping and tailings pumping systems. The flotation concentrate will undergo thickening onsite before the thickened concentrate slurry is pumped via a dedicated pipeline to the concentrate filtration facilities at the Port of Lae. The copper concentrate grades are expected to average approximately 29% copper and 15 g/t gold.

The Watut processing plant will be initially designed to treat approximately 8.4Mtpa of milled feed for the first three years of operations and progressively expanded over the next two years to accommodate the ramp up in mine production. These expansions include:

- an additional ball mill and flotation cells in year 4 to ramp up mill throughput rates to just under 17Mtpa; and
- a new pyrite flotation and regrind circuit in year 5 to accommodate higher metasediment content found in the ore feed.

After extensive studies, deep sea tailings placement was identified as the proposed method of tailings management and has been permitted in the project environmental permit. While other options (including dry-stacking and land-based tailings storage facilities) were also considered, significant risks and challenges were identified with land-based alternatives, including the project area's complex geology (e.g. seismicity and active faulting), proximity to areas with high traditional heritage values and susceptibility to heavy rainfall. A 103km-long tailings pipeline will run overland from the mine site to the outfall area located east of the Port of Lae. The tailings slurry will be discharged from an outfall pipeline terminus located approximately 200m below the ocean surface.

Infrastructure Development

Based on the 2018 updated feasibility study, the total initial capital expenditure to commence commercial production is approximately \$2.8 billion. The estimated capital spend includes significant investment in new infrastructure due to the remote location of the greenfield project. Specifically, these investments include the construction of:

- modular designed power plant to ensure a reliable base load power supply;

Annexure 1. Independent Expert's Report

GRANT SAMUEL



- fuel supply infrastructure, including fuel off-loading and storage facility located in the Port of Lae and an 87km pipeline for delivery of fuel oil from Lae to the power plant. Further work will continue on identifying other power solutions which may include hydro, gas, renewable and hybrid;
- a new tailings pipeline (to the Deep Sea Tailings Placement outfall location) and a new concentrate pipeline (to the new port facilities at Lae);
- new port facilities located at the Port of Lae that will be designed to handle, store and export the peak production rate of 84,000 wet metric tonnes of copper concentrate per month;
- new road infrastructure (including a 35km highway extension, five bridges and community roads); and
- other mine facilities such as a maintenance workshop and accommodation facilities.

Resources and Reserves

Reported mineral resources (100% basis) at Wafi-Golpu are summarised below:

WAFI-GOLPU – MINERAL RESOURCES AT 30 JUNE 2023 (100% BASIS)³

	MEASURED				INDICATED				INFERRED				TOTAL VOLUMES			
	Ore (Mt)	GRADE			Ore (Mt)	GRADE			Ore (Mt)	GRADE			Ore (Mt)	Au (Moz)	Cu (Mt)	Ag (Moz)
		Au (g/t)	Cu (%)	Ag (g/t)		Au (g/t)	Cu (%)	Ag (g/t)		Au (g/t)	Cu (%)	Ag (g/t)				
Golpu	--	--	--	--	690	0.71	1.10	1.30	140	0.63	0.85	1.10	830	18.8	8.7	32.6
Wafi	--	--	--	--	110	1.70	--	4.40	37	1.40	--	4.20	147	7.3	--	20.0
Nambonga	--	--	--	--	--	--	--	--	48	0.69	0.20	--	48	1.1	0.1	-
Total													1,025	27.2	8.8	52.6

Source: Newcrest and Grant Samuel analysis

Reported ore reserves (100% basis) at Wafi-Golpu are summarised below:

WAFI-GOLPU – ORE RESERVES AT 30 JUNE 2023 (100% BASIS)³

	PROVED				PROBABLE				TOTAL VOLUMES			
	Ore (Mt)	GRADE			Ore (Mt)	GRADE			Ore (Mt)	Au (Moz)	Cu (Mt)	Ag (Moz)
		Au (g/t)	Cu (%)	Ag (g/t)		Au (g/t)	Cu (%)	Ag (g/t)				
Golpu	--	--	--	--	400	0.86	1.20	--	400	11.0	4.9	--
Total					400	11.0	4.9	--				

Source: Newcrest and Grant Samuel analysis

The Golpu deposit is the largest and most advanced deposit within the Wafi-Golpu project. It accounts for over 80% of the project's total mineral resource (including essentially all contained copper and the majority of contained gold in mineral resource). It is the only deposit that has any recognised ore reserves. Mineral resources were estimated on the basis of a cut-off grade of \$22.29/t milled. The cut-off grades for ore reserves are substantially higher and variable cut-off grade (around \$19-60/t NSR), reflecting the different breakeven costs for each of the block caves.

The remaining mineral resources sit within the:

- Wafi deposit, which accounts for approximately 14% of total mineral resource and is estimated on the basis of a cut-off grade of 0.40 g/t for non-refractory gold and 0.90 g/t for refractory gold. The higher cut-off grade for refractory gold reflects the costlier pre-oxidation treatment required and the lower overall recoveries of the metals; and
- Nambonga deposit, which accounts for less than 5% of total mineral resource (all of which is classified as "inferred") and adopts a cut-off grade of 0.50 g/t of gold.

GRANT SAMUEL



The mineral resources and ore reserves statement for the Wafi-Golpu project was last updated in 2018. Newcrest has not reported any changes to the estimates since the last update.

7 Fruta del Norte

Overview

Fruta del Norte hosts the largest gold deposit in Ecuador and is amongst the highest grade operating gold mines in the world. It is hosted within the La Zarza concession, which is located within a 150km long copper-gold province in the Cordillera del Cóndor region along the border between Ecuador and Peru.

The region has historically been evidenced to hold high gold mineralisation and has hosted artisanal mining activities since the early 1900s. Modern prospective activity in the region commenced in the 1980s. Following the acquisition of the project tenements by Kinross Gold in 2008, development studies for a commercial scale gold mine accelerated. Over the next six years, Kinross completed a series of studies and drilling, culminating in the completion of a feasibility study in 2011 that supported the declaration of maiden ore reserves at the project site. In 2013, Kinross elected to cease development of Fruta del Norte, citing unsuccessful negotiations with the Government of Ecuador on securing a mining lease and eventually sold the project to Lundin Gold in 2014 for \$240 million.

Since acquiring Fruta del Norte, Lundin Gold has met major development milestones including:

- completing an independent feasibility study on potential underground gold mine (2016);
- approval of the Environmental Impact Study by the Government of Ecuador for the construction of the Fruta del Norte mine (2016);
- securing initial project financing package (i.e. GPCA, SCFA and offtake agreement) from Orion Resource Partners and Blackstone Tactical Opportunities (2017);
- approving the \$680+ million development of the mine (2017);
- Lundin Gold closed a senior secured project finance facility of US\$350M with a syndicate of lenders for fund mine construction (2018);
- establishing a strategic partnership with Newcrest to secure additional project funding (2018);
- producing first ore and delivering first export of gold concentrate and gold doré (2019); and
- reaching commercial production (2020).

The mine is wholly owned by Lundin Gold (in which Newcrest holds a 32% interest). It has completed its ramp-up and is operating at (or above) nameplate mining and processing capacity. Due to its location, Fruta del Norte markets and sells its products to a different customer base than Newcrest's mineral assets. Gold concentrates are typically sold under long term contracts (3-8 year terms) to international smelters located in Finland, Germany, Bulgaria, Canada, Taiwan and China. Gold doré is sold solely to Newcrest under the offtake agreement (see Section 3.3 of the full report).

Mining and Processing

The mine can be broadly categorised into three distinct areas — the high grade Central Zones (which hosts the greatest proportion of gold and silver in the deposit), the North Zone and the South Zone (which hosts the lowest grades and where mineralisation is generally less continuous). Mining is currently focused in the Central and North Zones, with mining in the South Zone expected to commence in CY28.

Underground mining at Fruta del Norte is by:

- longhole open stoping (with paste backfill) that is undertaken across most mining areas where ground conditions can support 25m levels and more regularly sized stopes that are 12-15m wide; and

Annexure 1. Independent Expert's Report

GRANT SAMUEL



- drift-and-fill mining that is selectively undertaken in areas with poorer ground conditions that can only support much smaller stopes (i.e. 5m wide by 5m height).

Eight separate stopes are actively mined in parallel to support production rates of around 4,200-4,400tpd (i.e. up to 1.6Mtpa). ROM ore is trucked from the underground mining area to the surface, where it is dumped directly into the crusher feed bin (or ROM stockpile), from which it is reclaimed and processed via a conventional primary crusher and grinding circuit to prepare it for treatment.

The process plant adopts conventional gravity-flotation-cyanidation processes to produce gold concentrate and gold doré. It was originally designed to a 3,500tpd nameplate but was subsequently expanded in CY21 to treat up to 4,200tpd (although actual throughput has been higher). Lundin Gold is undertaking further studies to evaluate the potential to further debottleneck to plant to process 5,000tpd (around 1.8Mtpa).

Tailings from the plant can be processed further to produce paste for underground mine backfill or stored at the on-site tailings storage facility.

Resources and Reserves

As at 31 December 2022, Lundin reported the following for Fruta del Norte (on a 100% basis):

- 32.2Mt mineral resources containing 8.5Moz of gold (at around 8 g/t gold) and 12.4Moz of silver; and
- 18.0Mt ore reserves containing 5.0Moz of gold (at 8.7 g/t gold) and 6.6Moz of silver.

Mineral resources are estimated on the basis of a cut-off grade of 3.4 g/t gold (although it is relatively insensitive to cut-off grades between 2-4 g/t gold). Cut-off grades for ore reserves are marginally higher and vary based on mining method. Ore reserves in longhole open stoping mining areas are based on a cut-off grade of 4.19 g/t gold whereas those in drill-and-fill mining areas are based on a 5.0 g/t cut-off grade.

Operating Performance

The historical operating performance of Fruta del Norte for CY20 to CY23 June year-to-date is summarised below:

FRUTA DEL NORTE - OPERATING PERFORMANCE (100% BASIS)

	CY20 ACTUAL	CY21 ACTUAL	CY22 ACTUAL	JUNE 2023 YTD ACTUAL
<i>Total production</i>				
Total ore mined (kt)	813	1,558	1,492	832
Total ore treated (kt)	906	1,416	1,559	811
Total gold produced (koz)	242	429	476	270
<i>Head grade</i>				
Gold (g/t)	9.5	10.6	10.6	11.6
Recovery (%)	85.9%	88.6%	89.5%	89.3%
<i>Financial metrics</i>				
EBITDA (\$ millions)	206	436	467	309
AISC (\$/oz)	773	762	805	765
Capital expenditure (\$ millions)	42	54	54	
<i>Revenue split</i>				
% of revenue from gold	100%	100%	100%	100%
% of revenue from copper	--	--	--	--

Source: Lundin Gold and Grant Samuel analysis

Since reaching commercial production in March 2020, Fruta del Norte has consistently ramped up to consistently produce over 400koz of gold per annum. The increase in ore treatment throughput in CY22 and CY23 to-date was supported by the completion of the mill expansion project in late CY21. Head grades



GRANT SAMUEL



have remained consistently at or around 10 g/t gold although the record head grades realised in Q2 CY23 was largely attributable to the deferral of lower grade stopes (while Lundin Gold completed additional geotechnical work to maximise mining recovery in those areas). AISC has been largely stable despite rising inflationary pressures and higher sustaining capital requirements.

8 Exploration and Other Development Activities

Overview

Discovery of new deposits is an important element of Newcrest's growth strategy. Newcrest's exploration program consists of both:

- brownfield exploration, which focuses on identifying new resources at or near existing mines to potentially extend the mine lives. This includes the exploration targets in the Paterson Province (surrounding the Telfer mining centre, including a farm-in agreement with Antipa and two joint venture agreements with Greatland), the broader Red Chris joint venture regional land package and Gossan Hill/Golden Marmot (part of Brucejack); and
- greenfield exploration, which focuses on discovering high-value gold and copper deposits across different geographies such as in Australia (in Queensland and the Northern Territory), Canada, the United States and Ecuador.

The principal targets are large porphyry type gold-copper deposits and high grade epithermal gold deposits and other gold-bearing deposits.

Newcrest's exploration activities are complemented by alliances with explorers (e.g. exploration earn-in agreements or joint venture arrangements) or direct investments (e.g. equity investment in listed explorers and/or developers such as SolGold, Azucar, Antipa, Metallic Minerals and Headwater).

Newcrest's greenfield exploration activities in various countries are summarised below:

NEWCREST - SUMMARY OF EXPLORATION TARGETS AND DEVELOPMENT ACTIVITIES

PROJECT NAME	LOCATION	DESCRIPTION
Spring Peak Project	Nevada, United States	<ul style="list-style-type: none"> ● Earn-in agreement with Headwater that gives Newcrest the option to acquire up to a 75% interest in the project ● Targeting high grade gold mineralisation
Lodestar Project	Nevada, United States	<ul style="list-style-type: none"> ● Earn-in agreement with Headwater (see Spring Peak Project)
Midas North Project	Nevada, United States	<ul style="list-style-type: none"> ● Earn-in agreement with Headwater (see Spring Peak Project)
Mahogany Project	Oregon, United States	<ul style="list-style-type: none"> ● Earn-in agreement with Headwater (see Spring Peak Project)
Appaloosa Project	United States	<ul style="list-style-type: none"> ● Earn-in agreement with Gunpoint Exploration Limited ("Gunpoint") that gives Newcrest the option to acquire up to a 75% interest in the project (and an additional 25% post the earn-in period) ● Targeting underexplored mineralised zone directly north of Gunpoint's Talapoosa gold-silver project
Gamora Project	Ecuador	<ul style="list-style-type: none"> ● Earn-in agreement with Lundin Gold that allows Newcrest to acquire up to a 50% interest in eight exploration concessions to the north and south of the Fruta del Norte mining operation by spending \$20 million over a five year period¹¹ ● Targeting copper-gold porphyry mineralisation
Mt Coolon Project	Queensland, Australia	<ul style="list-style-type: none"> ● Farm-in agreement GBM Resources Limited that allows Newcrest to acquire up to a 75% interest in the project tenements by spending A\$25 million and completing a series of exploration milestones in a three-stage farm-in over six years (starting 2023) ● Targeting high grade gold mineralisation in the Drummond Basin

¹¹ Under the earn-in agreement, Newcrest is committed to spend a minimum of \$4 million over the first 24 months of the agreement and has the option to spend a further firm \$6 million over the following 18-month period to earn an initial 25% interest in these tenements. By spending an additional \$10 million within five years, Newcrest can earn a further 25% interest in these tenements.

Annexure 1. Independent Expert's Report

GRANT SAMUEL



NEWCREST - SUMMARY OF EXPLORATION TARGETS AND DEVELOPMENT ACTIVITIES (CONT)

PROJECT NAME	LOCATION	DESCRIPTION
Tennant East Project	Northern Territory, Australia	<ul style="list-style-type: none"> Located 200km east of Tennant Creek spanning across ~4,500km² Targeting undercover extensions of known iron-oxide copper-gold deposits
Namosi Project (Waisoi and Wainaulo)	Fiji	<ul style="list-style-type: none"> Owned through Newcrest's 73.03% interest in the Namosi joint venture Located approximately 30km west of Suma (capital of Fiji) Contains copper mineralisation
Boomerang	Canada	<ul style="list-style-type: none"> Located in British Columbia and comprises a land package of nine tenements totalling 37km²
Junction Reefs	New South Wales, Australia	<ul style="list-style-type: none"> Located 10km south of Cadia in Lachlan, NSW covering approximately 290km² (with an additional 266km² under application)

Source: Newcrest

The vast majority of these exploration targets and development projects are early stage. The most advanced of the projects is the Namosi Project, for which Newcrest is undertaking selective studies for future development. With the exception of this project, no mineral resources have been identified by Newcrest for these exploration targets at the date of this report.

The Namosi Project is discussed further below:

Namosi Project

The Namosi Project is located in the southeastern quadrant of Viti Levu, the main island of Fiji and approximately 30km northwest of Suva, the national capital. The project area covers 400km² of tropical mountainous terrain and is situated within a Special Prospecting Licence granted by the Government of Fiji (which is due for a renewal in late 2023).

Copper-gold mineralisation in the region was first discovered in the early 1990s. A maiden low grade open pit copper-gold resource in excess of 900Mt at the Waisoi deposit was recognised shortly after. Over the following decade, ongoing exploration activity centred around the Waisoi area and identified additional copper and gold prospects supportive of a large copper-gold porphyry mineralised system. The Namosi joint venture was established between Newcrest (as the majority owner and manager of the joint venture), Nittetsu Mining Co. Ltd and Mitsubishi Materials Corporation in 2007. The joint venture was created to advance previous exploration programs and continue to explore for copper-gold mineralisation in the Namosi Project tenements.

Over the next fifteen years, the Namosi joint venture undertook further drilling and exploration programs as well as a series of conceptual and development studies. Main areas of mineralisation were found in:

- Waisoi deposit, which demonstrates low grade copper-gold mineralisation but accounts for nearly 90% of the Namosi Project's total resources. The Waisoi deposit has been the subject of the conceptual and development studies for an open pit mine; and
- Wainaulo deposit, which is a copper-only deposit but requires further drilling and testing to confirm the mineralisation (all mineral resource is classified as inferred).

The reported mineral resource and ore reserve statement as at 30 June 2023 indicates that the Namosi Project has approximately 8Mt of copper and 7Moz of gold in mineral resources (albeit at very low grades of approximately 0.1 g/t gold and 0.4% copper). More than 80% of the mineral resource is classified as indicated, with the remaining balance categorised under inferred mineral resource.

Prior pre-feasibility studies have supported the recognition of ore reserves at the Waisoi deposit, where the joint venture contemplated the development of an open pit mine that would have a production capacity of 60Mtpa, processing capacity of 17Mtpa ROM ore and produce an average of up to 300kt of copper



GRANT SAMUEL



concentrate per annum. However, these studies have not advanced beyond the pre-feasibility stage. In 2018, Newcrest de-recognised the ore reserves following further studies that highlighted challenges that rendered these mineral resources not economically mineable under the prevailing economic and technical assumptions at the time.

Since then, Newcrest has continued to undertake selective studies for future development, particularly focusing on a combination of an open pit mine and underground block cave as an alternative.

G R A N T S A M U E L



APPENDIX 3

GOLD AND COPPER MARKETS

1 Gold

1.1 Background

Gold is a precious metal that is valued for its beauty and is primarily considered a store of value or symbol of wealth and status in many cultures. It is used or consumed in:

- jewellery; and
- industrial applications (e.g. electrical components) as a result of its malleability and electrical and thermal conductive properties.

However, its primary role is as a store of wealth (despite not generating any income). The vast majority of gold that has ever been mined remains in existence due to its “indestructible” nature. The estimated aggregate global inventory of gold is approximately 70 times annual mine production of new gold.

1.2 Gold Production

Gold mines can be developed in a wide variety of deposits but can generally be found in:

- placer mines, in which segregated and concentrated grains of gold can be found mixed with sand and gravel such as along beaches, rivers and streambeds. Applying high pressure water and gravity are typically sufficient to separate gold from the surrounding material. Placer mining was historically the most important method of mining gold but available deposits have largely been exhausted;
- lode mines (or hard rock mines), in which gold occurs as veins in fractured rock (and consequently generally of lower grade) and are dispersed within the Earth's crust. Due to the bulk volumes of ore that needs to be mined to recover economical amounts of gold, lode mining involves extensive crushing, grinding and processing. Today, lode mining is the most widely used mining method; and

Gold also occurs in copper, zinc and lead deposits in quantities that reports to concentrates during the flotation process allowing the gold to be recoverable as a by-product in the refining of these metals.

The orebodies usually contain small elements of gold that are generally measured in g/t (e.g. the highest grade deposits owned by Newcrest average approximately 8-9 g/t of gold in ore reserves). Accordingly, gold ore undergoes several stages of processing to recover pure gold metal. The selected processing methodology depends in part on whether the ore is:

- non-refractory (or “amenable”), which means that gold particles can be extracted at sufficient recovery rates using cyanide. Non-refractory ore typically yields gold recovery rates of more than 88% and are generally the cheaper option; and
- refractory, which means that gold particles are ultra-fine and disseminated throughout the ore (in some cases enclosed in sulphides). Accordingly, they require more sophisticated (and expensive) treatment methods to liberate gold particles from the sulphides and to eliminate other material occurring in the ore. Refractory ore generally has higher grades of gold.

The following diagram outlines a simplified flowsheet for producing gold:





GRANT SAMUEL



GOLD – ILLUSTRATIVE VALUE CHAIN (SIMPLIFIED)

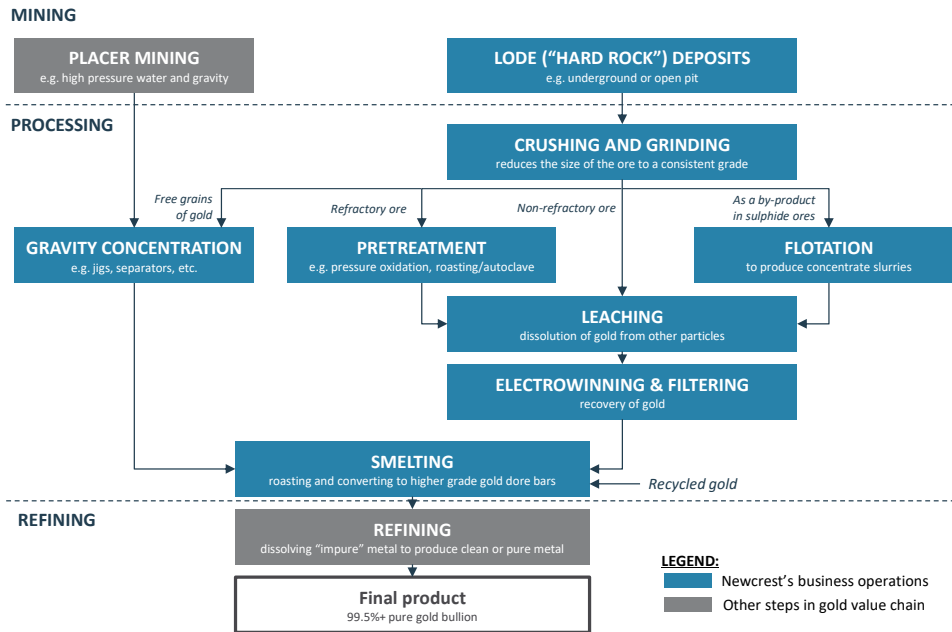

Grant Samuel analysis

Typically, ore is not readily traded and it is typically first processed on site to produce either metal concentrates or gold doré bars to reduce transport costs and minimise variability in product quality for further refining into gold bullion (and other by products).

Gold doré is an intermediate product between ore and refined gold bullion and can be characterised as a partially refined metal. Product quality is highly variable as there is no specific product standard for gold doré. For example, gold doré bars can carry gold content ranging anywhere from 50% to 75% gold and the individual bars can weigh up to 25kg. Due to its intermediate nature, gold doré buyers are typically limited to specialist dealers, gold refineries and mints. On the other hand, gold bullion is a refined product that contains at least 99.5% gold and is subject to a stricter regime of product standards in order to qualify for trading on global exchanges (see Section 1.3).

Newcrest’s mineral assets produce two products; gold doré bars, which are refined by third party gold refineries then sold by Newcrest as gold bullion to its customers and gold-bearing copper concentrates, which are refined by third party smelters primarily located in Asia.

1.3 The Gold Market

This section examines the supply and demand dynamics of the gold market. As a result of the nature of gold as a store of wealth, there are distinct components to demand and supply. Demand includes consumption (where gold is “used” in the production of jewellery and electronics) and investment (e.g. central banks and ETFs buying for investment purposes). Supply come from new production (approximately 3kT per annum), recycling and from gold inventories held in vaults across the world (approximately 210kT).

Consumption

Consumption of gold is principally attributable to jewellery fabrication and, to a lesser extent, industrial applications (e.g. electronics products and other technologies). Consumption demand for gold has

Annexure 1. Independent Expert's Report

GRANT SAMUEL



fluctuated across a wide range (of around 1,500-3,000t per annum), but has recently been around 2,500t per annum:

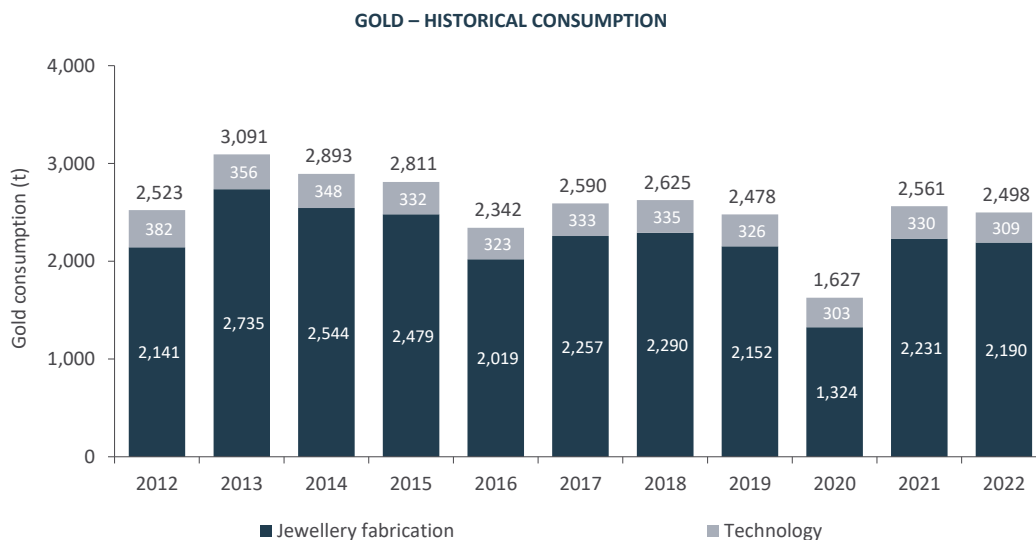

Source: World Gold Council

Some of this consumption is ultimately recycled.

Primary Supply

Gold production is highly fragmented. It is led by major mining companies such as Newmont, Barrick and Newcrest but the majority comprises a multitude of smaller gold producers such as junior gold producers and artisanal miners (the latter of which is estimated to comprise nearly 20% of annual production¹).

Operating gold mines are widely dispersed across the globe, with the top ten producing countries accounting for just over 50% of global gold production. However, the composition of the top ten countries shifted over the past two decades. Mine supply from difficult-to-access jurisdictions such as China, Russia and Kazakhstan increased their share of global output from 14% in 2001 to around 24% by 2022, whereas more “stable” and “open” jurisdictions such as the United States, Australia, Canada and, until more recently, South Africa saw their share fall from 46% to 26% over the same period². Australia and Canada remain amongst the five largest producing countries.

New gold supply from global mine production has grown modestly over the past decade. This production is complemented by supply from recycled gold:

¹ Source: World Gold Council, Artisanal and Small-scale Gold Mining Report, March 2022.

² Source: CRU Gold sector consolidation has a long way to go, February 2023.



GRANT SAMUEL



GOLD – HISTORICAL SUPPLY

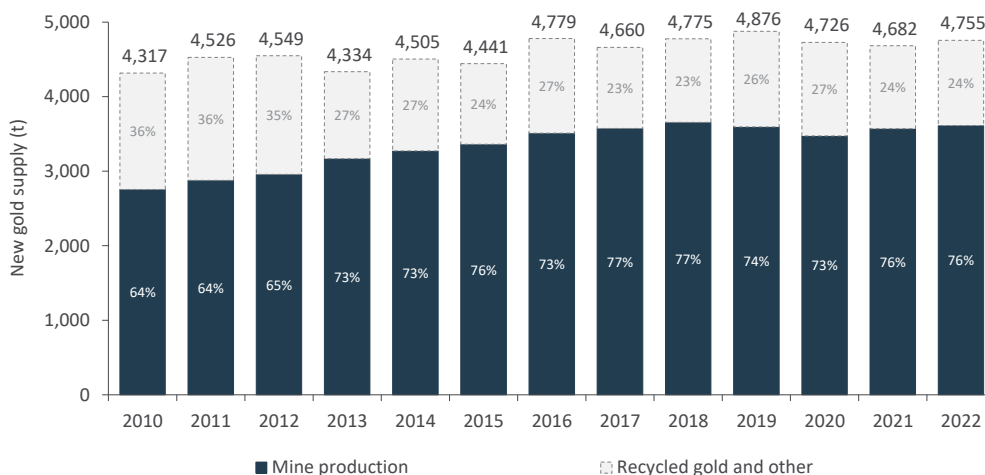

Source: Grant Samuel analysis

The aggregate new supply of circa 4.5-5.0kt per annum exceeds consumption by around 2kt per annum and adds (marginally) to the existing investment inventory of approximately 210kt of gold (or 7,400Moz)³ (with the surplus typically acquired by central banks and other investors).

Notwithstanding the historical stability in gold production, the long term supply outlook for mined gold is fraught with some uncertainty:

- gold ore reserves from major gold producers have been in historical decline (falling by over 30% since peaking in CY12⁴), leading to declining remaining mine lives (barring brownfield expansions or greenfield developments);
- new gold discoveries have been in long-term decline (notwithstanding the recent rebound in exploration expenditure), averaging only 25Moz gold per annum over the last ten years (and less than 10Moz per annum since 2019), down from well over 100Moz per annum between 1990 and 2010⁵;
- increased focus on brownfield exploration, which generally carries lower exploration, geological and project development risks than greenfield exploration. Equally, the upside potential of major gold discoveries is more limited from brownfield exploration activities;
- remaining ore is becoming more challenging (and expensive) to process. A growing proportion of mineral resources and ore reserves are refractory and often found in “safer” mining jurisdictions (i.e. those exposed to lower mining-regulatory and political risks)⁶. Accordingly, gold producers are increasingly facing a trade-off between regulatory/sovereign risks and technical risks as gold reserves in “safer” jurisdictions become increasingly more complex and expensive to produce (though this is somewhat mitigated by the often higher grades for refractory ore); and
- long lead times to production (estimated to be around 20 years⁷) highlight issues in relation to raising capital (particularly for junior gold producers), regulatory and social scrutiny (including engagement with local communities and traditional landowners), stringent environmental regulation and increasingly remote project areas which make it challenging to construct the requisite infrastructure.

³ Source: World Gold Council, 2023. Includes significant component of jewellery inventories.

⁴ Source: McKinsey, Gold industry M&A: Riding the new wave buoyed by lessons from the past, February 2021.

⁵ Source: S&P Global Market Intelligence, Major gold discoveries by year, 1990-2021.

⁶ Source: McKinsey, Refractory gold ores: Challenges and opportunities for a key source of growth, March 2021.

⁷ Source: McKinsey, Can the gold industry return to the golden age, February 2019.

Annexure 1. Independent Expert's Report

GRANT SAMUEL



Collectively, these issues are creating what some market commentators refer to as a brewing “reserves crisis”. Rising production costs (measured in AISC) in recent years following a period of aggressive cost rationalisation in the early-to-mid 2010s has placed additional pressure on the earnings profiles of gold producers (although this has been mitigated by stronger gold prices in the last 3-5 years).

The combination of these factors has pushed gold producers to turn to alternative means to protect their profitability and pursue growth. In this environment, mergers and acquisitions have become an important avenue for individual gold producers to execute their growth strategy as they seek to replace and grow ore reserves (albeit it does not directly add to total gold production).

Investment Markets

Gold is a highly liquid, globally traded commodity. Trading largely represents interests in existing inventory largely held in the form of gold bullion. While only around 40% of total above-ground stocks (approximately 80kt) are readily available for trade (e.g. not stored as long term central bank holidays), average daily trading volumes for gold is typically at or around 2kt (and even higher during periods of market stress).

Physical gold can be traded either over-the-counter (i.e. bilateral agreements), on an exchange (i.e. regulated platforms) or through intermediaries (e.g. wholesalers).

Market participants include:

- brokers, wholesalers, market makers and other intermediaries;
- bullion banks (including large US commercial and investment banks);
- central banks (and other global institutions) that hold gold reserves;
- industry participants such as commodity trading companies, gold refiners and mining companies; and
- investors and speculators. Institutional investors include ETF gold funds that have to match their physical holdings to their securities on issue.

There are also very large derivatives (futures and options) markets such as COMEX and the Shanghai Futures Exchange as well as other secondary market centres (e.g. Dubai, India, Japan, Singapore and Hong Kong). Transactions in these markets are largely settled in cash with very little physical delivery of gold.

The majority of transactions occur through either the London Bullion Market Association (an over-the-counter market), i.e. COMEX and the Shanghai Futures Exchange. While aggregate trading volumes in London and New York gold markets are substantially larger than the gold market in China, the Shanghai Gold Exchange is the largest market for physical gold.





GRANT SAMUEL



AVERAGE DAILY TRADING VOLUMES IN CY22

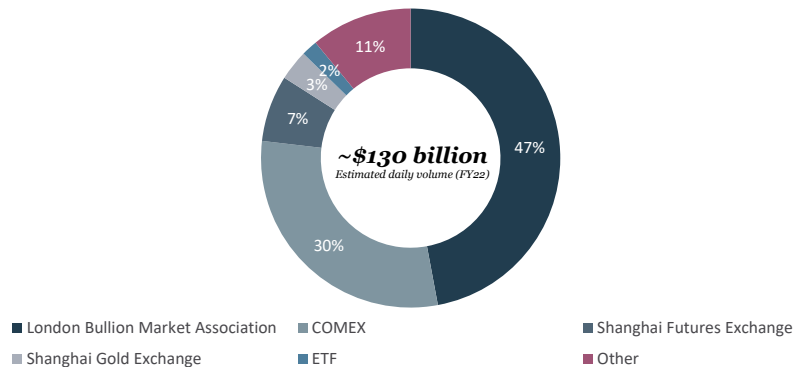

Source: World Gold Council

Prices

Gold is essentially a financial instrument (or a means to store wealth). Accordingly gold prices do not move in line with the changes in supply and consumption demand and have little or no relationship with the marginal cost of production. Instead, gold prices are effectively set by the secondary trading of existing inventories driven by financial investors (including through the significant inflows into gold-based ETF products in recent years). This is particularly the case in periods of market uncertainty or turmoil, with gold widely viewed as a “safe haven” and as an effective hedge against currency depreciation, inflation and other market risks.

Historical spot gold prices since January 2017 are illustrated below and show a generally upward progression (albeit not during 2022):



Source: Bloomberg

While gold prices remained largely within a narrow range of \$1,200-1,400/oz throughout 2017 and 2018, emerging risks from unresolved Brexit negotiations, US-Russia diplomatic tensions and ongoing US-China trade war fuelled the increase in gold prices which ended 2019 at just over \$1,500/oz. As a non income producing asset class, gold prices were also supported over this period by declining interest rates (which

GRANT SAMUEL



lowered the opportunity cost of holding a non income producing asset such as gold). Gold prices increased further following the spread of the COVID-19 pandemic as demand for “safe haven” investment products such as gold spiked following unprecedented levels of monetary stimulus undertaken by central banks across the world (reducing interest rates to virtually zero and in some cases negative).

However, more recent movements in the gold price appear to be inconsistent with being an effective hedge against inflation and economic uncertainty (i.e. stock market movements). While gold prices briefly reached a record high of more than \$2,000/oz in early 2022 following the start of the Russia-Ukraine War, gold price drifted down (along with the rest of the stock market) to a range of \$1,600-1,700/oz later in the year before rebounding to around \$1,800/oz to close the year (also recovering along with the rest of the stock market). The rebound in prices continued for the most of 2023 to-date, surpassing \$2,000/oz in April but retreated to around \$1,950/oz towards the middle of the year. The strength in gold prices (despite the sharp rise in interest rates) was likely assisted by the persisting inflationary pressures and economic and geopolitical uncertainty.

2 Copper

2.1 Background

Unlike gold, copper is a “base” metal primarily used in industrial applications. Copper is valued for its electrical and thermal conductive properties, its durability and its strength. It is not used as a store of value and production is largely consumed (with ebbs and flows in inventories). Pricing is largely determined by demand, supply and marginal costs.

2.2 Copper Production

It occurs naturally in a variety of geological environments with the largest economic concentrations found in porphyry rock in which copper metal is more or less uniformly scattered throughout the rock. The copper minerals are generally found as either:

- copper oxides, which are more abundant near the surface but generally considered to be lower grade due to the lower concentration of copper. These ores typically are extracted by open pit mining; or
- copper sulphides, which are found deeper in the earth’s surface and typically have higher copper grades. These include bornite and chalcocite as well as secondary sulphides such as chalcopyrite (which have lower copper grades). Depending on the ore depth and surrounding geology, copper sulphide ores can be extracted through either open pit mining or underground mining.

Notwithstanding the differences in copper grades between different types of ore, the orebodies usually contain a percentage of copper that is generally less than 5% (and often as low as 1%). As such, copper ore typically undergoes several stages of processing to recover pure copper metal:



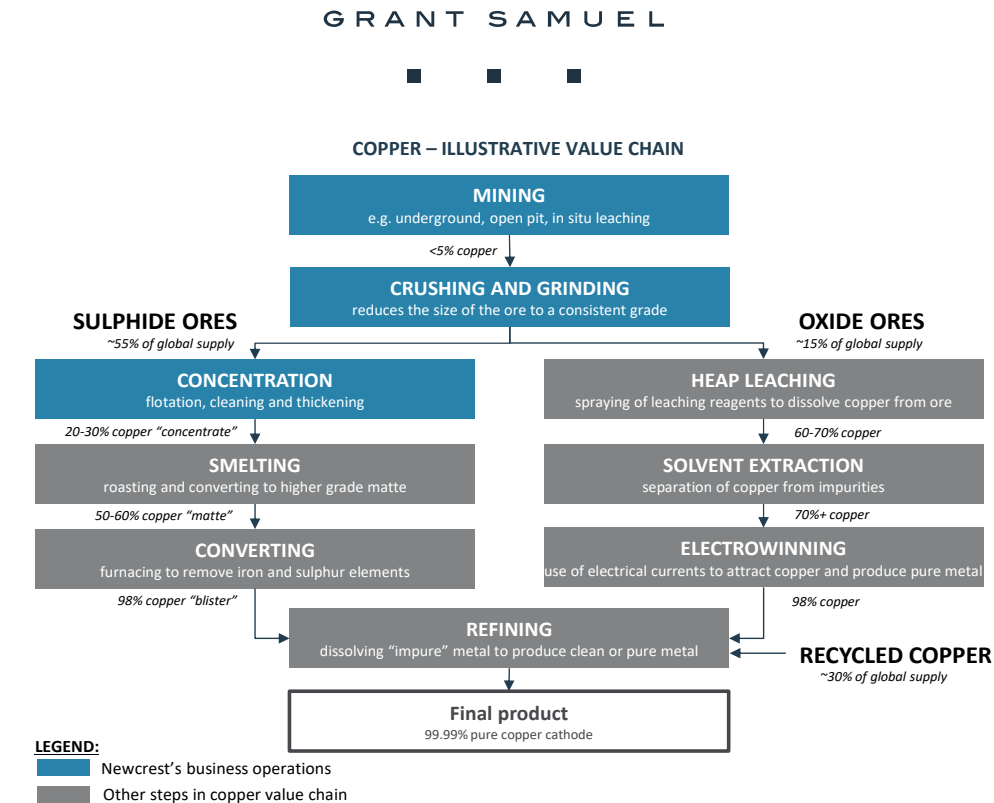

Source: Grant Samuel analysis

As ROM production is not as readily traded as the other product categories (due to its bulk size and weight), copper miners typically first process the ROM ore on site to produce copper concentrates (or further refinement and processing if it was extracted via heap leaching methods). This approach allows copper producers to reduce transport costs and minimise variability in product quality (e.g. copper grades).

The copper concentrates are primarily sold to smelters and refineries (typically under long term agreements), which further process the copper concentrate into higher grade copper metals (i.e. copper cathodes that contain 99.99% copper). Copper cathodes are shipped to mills and foundries where they are cast into wire rod (for wires), billets (to make tubs, rods and bars stock), cakes (for plate, sheets and foil) or ingots (for alloying or casting) which are then used as inputs for the final manufacture of copper-containing finished goods. Copper-based goods can be used in a wide range of applications including:

- electrical products and equipment (approximately 32% of consumption), which is the largest consumer of copper and used in the production of semiconductors, electric vehicle batteries and other batteries. Copper is valued particularly for its malleability, ductility and efficiency in transferring electricity at room temperature;
- building and construction (approximately 28% of consumption), which is the second largest consumer of copper. Copper is commonly used in plumbing, electrical wiring, water piping, roofing and a wide range of other applications;
- industrial machinery and equipment (approximately 12% of consumption), as an alloying element (given its durability, machinability and ease of casting with precision and tolerance) to produce gears, bearings and turbine blades;
- transportation (approximately 12% of consumption), particularly across the aerospace industry (as a copper alloy), railway industry (for electrification of switchgears and motor windings) and automotive industry (for wiring); and

Annexure 1. Independent Expert's Report

GRANT SAMUEL



- infrastructure (approximately 16% of consumption), including cables, transistors and inverters (which are used in the electricity transmission and distribution network infrastructure).

2.3 The Copper Market

Copper is a globally traded commodity. The value chain for copper is dispersed across several geographies, which often means that upstream copper production capacity may exceed downstream production capacity within individual countries (which in turn requires downstream producers to import the raw materials required to meet their production needs):

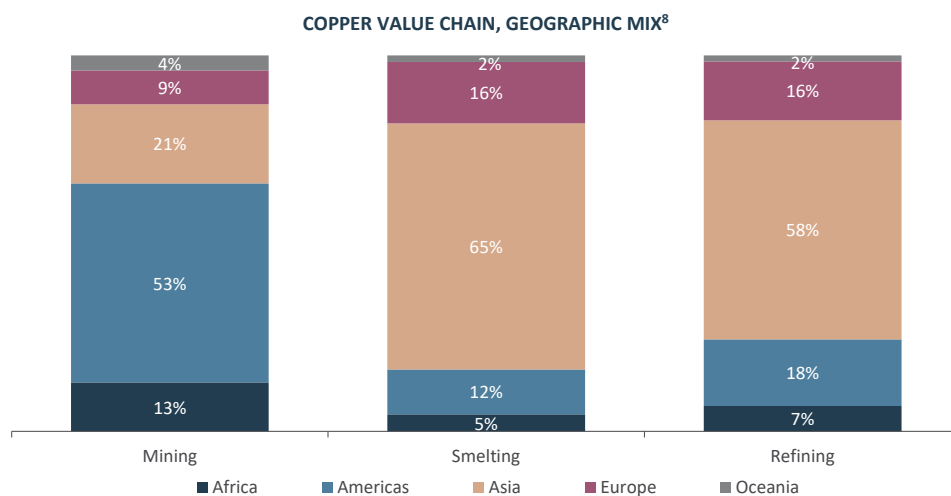

Source: International Copper Study Group, The World Copper Factbook 2022

Major product categories of copper that are traded in the global market include:

- copper concentrates;
- copper blisters (i.e. outputs from smelting and converting);
- copper cathodes and ingots (i.e. refined copper); and
- copper scrap and other copper-containing alloys.

Demand

Demand for copper has historically been correlated with population growth and industrial development, especially with building and construction activity. Over the last decade, demand for copper was primarily fuelled by the urbanisation and economic growth in China which saw annual consumption increase by nearly 5 Mtpa to over 13.5 Mtpa in 2021:

⁸ Includes 100% of copper mine production (i.e. oxides and sulphides). Mining and smelting includes all copper concentrate production and heap leaching outputs. Refining includes all refined copper metals product that undergo either traditional refinery methods (i.e. from copper concentrates to smelted matte products) or electrowinning.



GRANT SAMUEL



HISTORICAL AND PROJECTED REFINED COPPER DEMAND (IN CONTAINED METAL)

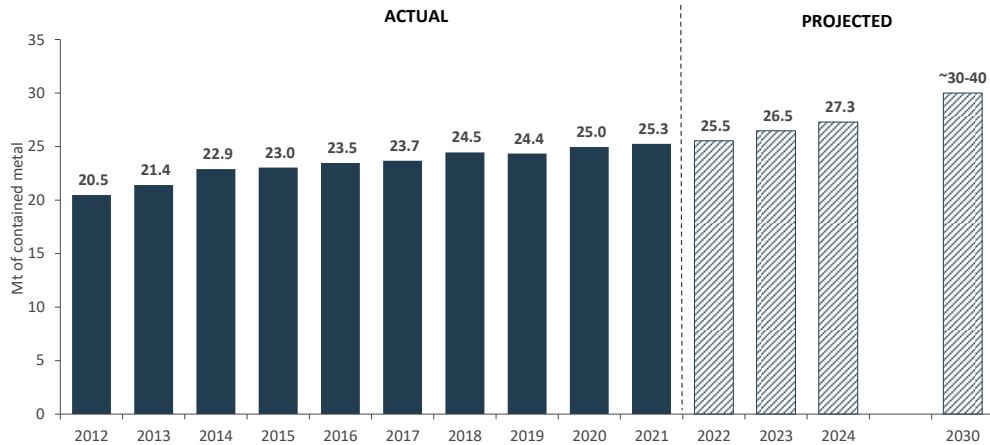

Source: International Copper Study Group, The World Copper Factbook 2022; S&P Global, The Future of Copper, 2022

In 2021, China comprised the largest share of the market, representing over 55% of global demand for refined copper in 2021. Developed industrialised countries including the United States (7%), Germany (4%), Japan (4%) and South Korea (2%) comprise the remainder of the five largest consumers of refined copper⁹ (collectively comprising approximately 73% of global demand). With the exception of China and the United States (both of which have their own domestic industry of copper ore and concentrate production), the other countries (e.g. Germany, Japan and South Korea) do not have large copper mining industries domestically and are consequently also the most active importers of copper ores and concentrate in the world¹⁰.

The demand outlook for copper remains positive. Long term demand projections by market analysts vary across a wide range, but most commentators project copper demand to grow by an average of between 2% and 5% per annum through 2030. While the continued urbanisation of developing countries will continue to be a driver of demand, the key contributors to growth over the next three decades primarily relate to the energy transition (particularly due to copper's role as the "metal of electrification"¹¹), including:

- increasing adoption of electric vehicles, which contain up to four times more copper than internal combustion vehicles and are expected to account for more than 60% of new vehicle sales by 2030¹²;
- increasing penetration of renewable energy technologies (e.g. wind power), which are estimated to require 4-6 times more copper than fossil fuel or nuclear energy sources due to the higher wiring and cabling requirements (as well as larger number of smaller generation units); and
- new renewable energy assets will need to be connected to the rest of the grid, which will require new energy transmission grid infrastructure that is reliant on copper for wiring, transformers and motors.

While the exact pace of the energy transition remains uncertain and there is some near-term economic and geopolitical uncertainty, long term demand for copper is underpinned by global climate ambitions over the next two decades that would lead to a material increase in copper consumption. Alternatives such as aluminium are sometimes used as substitutes for certain applications, but there are technical limits (e.g. conductivity, energy efficiency, corrosion resistance) that cap their efficiency and ability to adequately replicate copper's properties.

⁹ Source: Bloomberg

¹⁰ Source: International Copper Study Group, The World Copper Factbook 2022

¹¹ Source: S&P Global, The Future of Copper, 2022

¹² Source: International Energy Agency, Technology and innovation pathways for zero-carbon-ready buildings by 2030, September 2022

Annexure 1. Independent Expert's Report

GRANT SAMUEL



Supply

Mine production (either through the production of copper concentrates for smelting or through heap leaching and electrowinning techniques) is the primary source of copper supply. Chile and Peru are the two largest producers and collectively account for more than 35% of global production. The remainder of the eight largest producers include countries in developed mining jurisdictions (e.g. United States and Australia) as well as countries that have historically faced higher sovereign risks (e.g. China, Democratic Republic of Congo, Russia and Zambia). Canada sits just outside the top ten of the world's largest copper mine producing countries.

Most of the largest producers are either globally integrated commodity producers (e.g. BHP, Glencore) or state-owned corporations (Chile's Codelco). Pure-play copper producers are generally smaller in scale but nevertheless are often diversified across different geographies.

In 2021, global mine production capacity was approximately 26 Mtpa (operating at approximately 80-85% of capacity). Copper mine production has grown by an average of only 2.7% per annum over the last ten years reflecting the combined impact of a stagnant copper price environment during that period (which discouraged new investments in mines and ore processing facilities) and declining ore grades. However, supply growth is expected to accelerate over the next three to five years (to approximately 4% per annum) as the improved price environment in recent years has incentivised investments in new capacity (both new projects and expansion of existing operations):

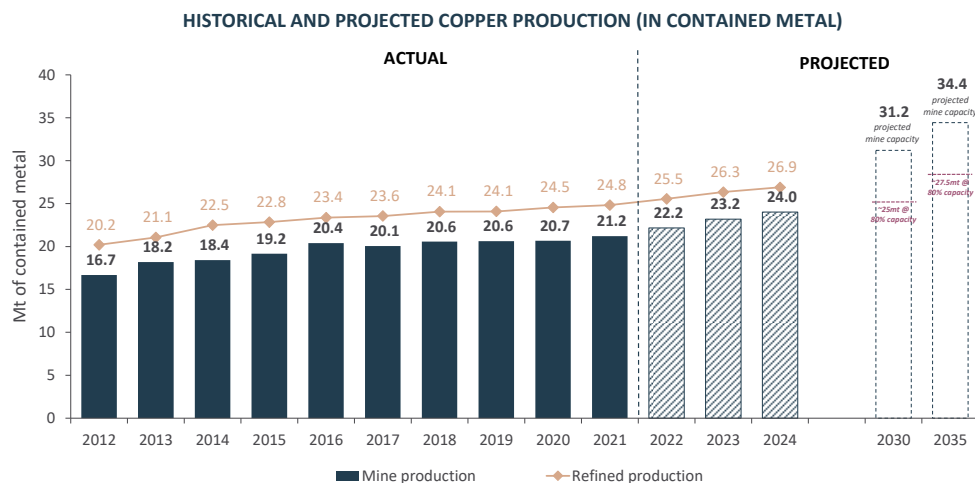

Source: International Copper Study Group, The World Copper Factbook 2022

According to the International Copper Study Group, total mine capacity is expected to reach more than 31 Mtpa by 2026 before reverting to historical growth rates of closer to 2.5% per annum as new supply (whether greenfield of capacity expansions) is offset by the natural loss of production from mine depletion and declining ore grades.

However, development of new copper supply is challenging and will require significant investment to meet the estimates set out above. The outlook for copper concentrate production (which represents approximately 80% of global production, excluding recycled scrap) is expected to peak by 2025 and then decline unless new projects are identified and accelerated for development¹³.

Developing new copper supply is subject to a number of constraints including:

¹³ Source: S&P Market Intelligence

GRANT SAMUEL



- declining ore grades, as global copper resources continue to be depleted. Average mined copper grades have declined by over 40% during the last three decades;
- scarcity of new copper projects of scale (especially in developed copper mining jurisdictions such as the United States and Chile);
- protracted development timelines, as increasing social and regulatory risks often lead to delays in receipt of project permits; and
- jurisdiction risks, particularly in relation to changes in tax and investment regimes and potential resource nationalisation. Some of the largest producers and resources are located in “risky” countries.

Moreover, the ability to bring new supply to the market is inherently dependent on individual mine economics which are impacted by the operating costs (e.g. mining costs, processing costs), capital requirements and copper price dynamics. In other words, the outlook for copper prices need to remain sufficiently robust to incentivise newer (and arguably more marginal) mines to be developed.

Alternatively, increasing the capacity utilisation of existing copper mines has its merits but is unlikely to be a long-lasting solution for supply. Historically, global capacity utilisation averaged between 80% and 85%, reflecting the cyclical movements in copper prices that work as an incentive for production. When prices are low, high cost and marginal operations may be idled (leaving unused mine capacity). In contrast, when prices are high, mine operators are incentivised to “sweat” even their marginal assets. Under this scenario, prices have to remain persistently high for these marginal assets to be an ongoing source of supply.

Another source of secondary supply is by recycling scrap, which accounts for approximately 30% of supply. While this is an invaluable source of supply for copper, there are also a number of practical disadvantages to recycling copper including the heterogenous nature of scrap (in terms of size, shape and quality), processing costs and, in some cases, import restrictions (which inhibit movement of scrap).

In short, it is unclear how long term supply of copper will meet the growing demands on the metal. Without a clear path forward for new supply, the growth in demand is expected to contribute to a persistent supply-demand deficit in the copper market.

Prices

Trading of copper is facilitated by commodity exchanges such as the LME, COMEX and SHFE which help integrate the global market by facilitating price transparency and providing a platform for trading of futures and options contracts so buyers and sellers can hedge against future price movements.

Due to the wide range of copper product categories that are actively traded in the market, most products are priced against the 99.99% pure copper cathodes that are quoted on the exchanges. These benchmark copper prices include LME Copper, SHFE Copper and COMEX Copper (although the LME captures the largest share of transactions and is widely accepted as the global benchmark).

Prices for copper concentrate sold by miners are calculated with reference to one of these benchmarks but adjusted for:

- metal content, to reflect the amount of copper metal recoverable from the concentrate;
- payable metal, to reflect the anticipated “margin” retained by the buyer;
- treatment and refinery charges, as the copper concentrate will still need to undergo further treatment before it can be sold as a refined metal product; and
- penalties, which reflect the presence of impurities (e.g. contaminants) in the concentrate that are harmful to the treatment and refinery processes.

Historical spot LME Copper prices since January 2017 are illustrated below:



Annexure 1. Independent Expert's Report

GRANT SAMUEL



LME COPPER SPOT PRICE
JANUARY 2017 TO JULY 2023



Source: Bloomberg

Due to copper's wide range of applications in cyclically advanced sectors (e.g. construction, electronics), its price movements have generally been considered a leading indicator for economic activity. Between 2017 and 2019, copper prices traded across a range of \$5,750/t to \$7,500/t (but mostly in the \$6,000-7,000/t range) with a slight downwards trend, reflecting the concerns of economic slowdown amidst rising geopolitical tensions (e.g. unresolved Brexit negotiations, US-Russia tensions and US-China trade war). The COVID-19 pandemic triggered an initial global slowdown in economic activity which led to a decline in copper prices (falling as low as \$4,630/t in March 2020).

However, copper prices staged a strong rebound over the next two years. Rising energy input costs pushed prices upwards. Global economies reopened and the subsequent economic rebound and shift in consumer demand for electronic products (including electric vehicles) further strained tightening supplies. Operating disruptions in some of the largest copper producing regions in South America have also contributed to record low commercial inventories. Limited investments in new capacity in the preceding years exacerbated these pressures. Collectively, these factors pushed copper prices to a record high of around \$11,300/t in October 2021 (and again to \$10,700/t in March 2022).

Over the next six months, copper prices fell sharply and quickly by approximately 33% to a low of \$7,170/t by mid 2022 as macroeconomic factors (e.g. rising inflation and a swift shift to tighter monetary policy by central banks across the world) and geopolitical tensions (e.g. Russia-Ukraine war) led to rising market concerns. The slow and uncertain recovery of the Chinese economy (as the largest consumer of copper) has also weighed on copper prices. However, increasing optimism in relation to the expected reopening (and rebound) of the Chinese economy in the latter half of 2022 and early 2023 led to a rebound in copper prices, which rose above \$9,330/t in January 2023. The renewed optimism wavered in subsequent months as Chinese demand remained tepid amidst the threat of a global recession. Since peaking in January, copper prices have trended downwards and fell briefly below \$8,000/t but have since rebounded to around \$8,500/t by August 2023.

G R A N T S A M U E L



APPENDIX 4
BROKER CONSENSUS FORECASTS

Newcrest has not publicly released earnings forecasts for FY24. Accordingly, the prospective multiples implied by the valuation of Newcrest in the Grant Samuel report are based on median broker forecasts.

Set out below is a summary of broker forecasts that provide research coverage of Newcrest in the Australian sharemarket:

NEWCREST – BROKER FORECASTS (\$ MILLIONS)

BROKER	DATE	FY24 REVENUE	FY24 REPORTED EBITDA	FY24 EBITDA
Broker 1	11-Aug-23	4,733	2,137	not disclosed
Broker 2	11-Aug-23	5,019	2,100	not disclosed
Broker 3	11-Aug-23	4,805	2,404	not disclosed
Broker 4	11-Aug-23	4,965	2,623	not disclosed
Broker 5	11-Aug-23	4,564	1,905	not disclosed
Broker 6	11-Aug-23	4,545	2,226	not disclosed
Broker 7	11-Aug-23	4,703	2,366	not disclosed
Broker 8	11-Aug-23	4,616	1,872	not disclosed
Broker 9	11-Aug-23	4,820	2,127	2,067
Broker 10	11-Aug-23	4,706	2,499	2,380
<i>Minimum</i>		4,545	1,872	2,067
<i>Maximum</i>		5,019	2,623	2,380
Median		4,720	2,182	2,224
Average		4,748	2,226	2,224

Source: Brokers' reports, Grant Samuel analysis

When reviewing this data the following should be noted:

- the forecasts presented above represent the latest available broker forecasts for Newcrest;
- the brokers presented are those who have published research on Newcrest following the release of Newcrest's FY23 results on 11 August 2023;
- as far as is possible to identify from a review of the brokers' reports, Grant Samuel believes that each of the brokers' earnings forecasts have been prepared on a consistent basis and do not incorporate any one-off adjustments or non-recurring items;
- Grant Samuel is aware of three other brokers that follow Newcrest. These brokers have not released any research on Newcrest that includes earnings forecasts subsequent to the release of Newcrest's FY23 results on 11 August 2023; and
- only two out of the 10 brokers forecast EBITDA. The other eight only forecast reported EBITDA, which includes share of profit/(loss) of associates. The median EBITDA of \$2,224 million (based on Grant Samuel analysis) is sufficiently close to Newcrest's FY24 Budget to be useful for analytical purposes.

GRANT SAMUEL



APPENDIX 5 REVIEW OF MARKET EVIDENCE

1 Overview

Newcrest operates a portfolio of producing and advanced development gold and copper mineral assets across Australia, Papua New Guinea and Canada. Accordingly, Grant Samuel has considered global transactions and listed companies involved in the production of gold in similar mining jurisdictions.

In particular, Grant Samuel has calculated the following for comparable transactions and comparable listed companies:

- historical and forecast EBITDA multiples;
- gold-only production multiples (for ease of reference, this is simply referred to as production multiples); and
- gold-only resource and reserve multiples (for ease of reference, these are simply referred to as resource and reserve multiples).

Other than price-to-net asset value multiples, these multiples are generally viewed as the most common valuation metrics for mineral assets that primarily produce gold.

2 Transaction Evidence

The gold sector has undergone a wave of consolidation over the past five years. Grant Samuel's research has identified a number of comparable transactions involving large and diversified gold producers or large scale gold producers with a targeted geographic presence in either Canada or Australia. Grant Samuel has also considered relevant transactions directly involving Newcrest's current portfolio of mineral assets (e.g. acquisitions of Pretium (Brucejack) and 70% of Red Chris).

Unlike most other sectors, transactions in the gold sector (particularly for large scale producers) have historically involved scrip in the consideration. Depending on the circumstances of the transaction, some of these may be best described as a "merger of equals" (which is typically priced at zero-to-nominal premiums over undisturbed prices) as opposed to a control transaction (which would typically attract a premium for control). "Mergers of equals" are typically excluded from the transaction evidence due to the lack of a full "control" premium being incorporated into the sale prices of these target companies. However, these transactions have been relatively common in recent years and, in any event, have involved the largest of the gold producers. Moreover, the market evidence does not appear to set out a clear distinction or discount for "mergers of equals" in most instances as they have generally been priced in line with other control transactions. Accordingly, Grant Samuel has considered these transactions in the analysis of market valuation parameters.

With the exception of Barrick's merger with Randgold Resources Limited ("Randgold") and Newmont's acquisition of Goldcorp Inc. ("Goldcorp"), all gold transactions occurred after the introduction of AASB16 (or equivalent) and therefore earnings, and the implied EBITDA multiples, are on a post AASB16 basis.

Grant Samuel has considered post synergy transaction multiples (where these are able to be calculated) on the basis that they can make a material difference to the effective multiple paid by the acquirer and can vary substantially from case to case.

The following charts set out the historical and forecast EBITDA multiples (with production multiples illustrated as dots) as well as the resource and reserve multiples for the identified transactions:





GRANT SAMUEL



RELEVANT COMPARABLE TRANSACTIONS

HISTORICAL AND FORECAST EBITDA AND PRODUCTION MULTIPLES

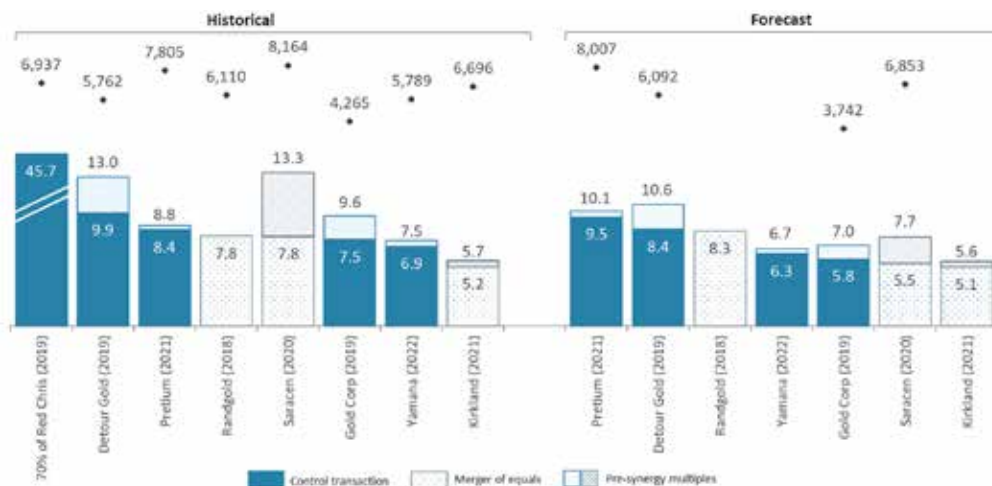

Source: Grant Samuel analysis^{1,2}

RELEVANT COMPARABLE TRANSACTIONS

GOLD-ONLY RESOURCE AND RESERVE MULTIPLES (\$/OZ)

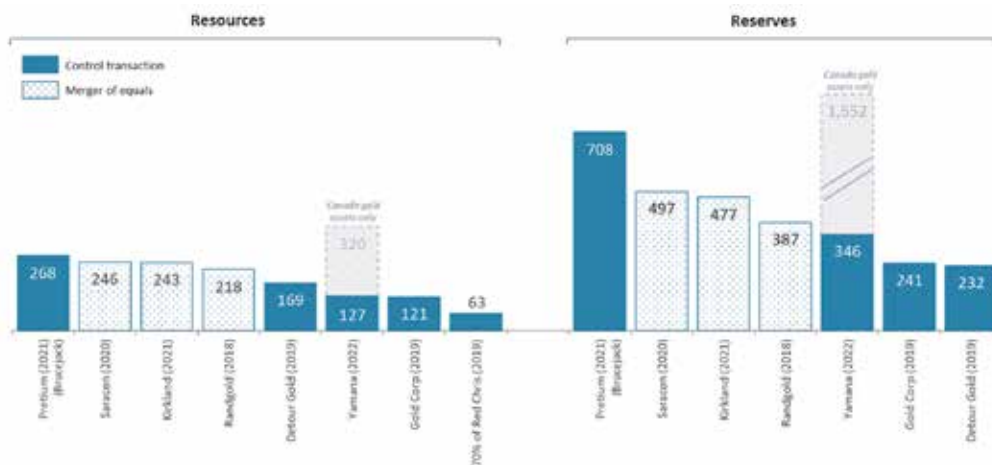

Source: Grant Samuel analysis^{1,2}

Even excluding outliers, transactions for gold producers have occurred across a wide range. In particular:

- historical EBITDA multiples range between 7 and 13 times, albeit with some more consistency at around 7.5-10 times (and around 7-8.5 times post-synergy EBITDA);

¹ Enterprise values are generally adjusted for non-controlling interests and equity accounted investments. In the case of Randgold and Goldcorp, the equity accounted investments accounted for a significant share of their value. As sufficient public information (e.g. net borrowings, EBITDA, production and reserves and resources) was available to calculate “see-through” valuation multiples for the equity accounted investments, the analysis reflects the blended multiples inclusive of these investments.

² Grant Samuel analysis based on data obtained from IRESS, S&P Global Market Intelligence and company announcements. Forecast production multiples are based on each listed producer’s published guidance or outlook for FY23 or CY23.

Annexure 1. Independent Expert's Report

GRANT SAMUEL



- forecast EBITDA multiples range between 7 and 10.5 times (and around 6-8 times post-synergy EBITDA); and
- resource and reserve multiples have occurred across a substantially wider range, although these multiples have generally trended higher in recent years.

Production multiples are another step removed from cash flows (compared to EBITDA) but generally fall in the \$5,500/oz to \$8,000/oz range.

In light of the wide variation of market evidence, it is difficult to determine a reliable range of earnings or resource and reserve multiples for gold assets. Accordingly, it is important to review the transaction evidence as a whole and not rely on any of the metrics in isolation.

EBITDA MULTIPLES

Newcrest's acquisition of a 70% interest in the Red Chris mine occurred at a significant premium over any of the other transactions. While the extremely high EBITDA multiples (more than 40 times) were impacted by the very low operating margins of the mine at the time and can clearly be considered an outlier, Red Chris had a number of attractive characteristics:

- scale and long reserve life, which (with the right resources and mining expertise) is expected to be the foundation for a multi-decade mining operation;
- strategic importance, as it gave Newcrest a measured foothold and immediate scale in North America across the vast mineral tenure landholdings in the highly prospective Golden Triangle region;
- growth opportunities, particularly to transform Red Chris from an open pit mine with limited remaining life into a large scale underground block caving mine that can extract a substantially larger proportion of its mineral endowment; and
- uniqueness of the asset, as not many orebodies are suitable for block caving. Newcrest's technical expertise in block caving operations was expected to be a key input to unlocking value from the next stage of the mine's expansion.

Most of the transactions that occurred at the upper end of the range generally exhibited similar characteristics:

- the merger of Northern Star Resources Limited ("Northern Star") and Saracen Mineral Holdings Limited ("Saracen") was motivated by a simplification of the ownership structure in the KCGM mining operations (which wholly owns the Super Pit gold mine). The merger followed Saracen's acquisition of Barrick's 50% interest in KCGM and Northern Star's acquisition of Newmont's 50% interest in the joint venture in two separate transactions in 2019³. While the transaction was structured as a "merger of equals" and did not explicitly include a control premium, the high historical EBITDA multiple (and middle-of-the-range forecast EBITDA multiple) reflected the confidence in the company's capital-light organic growth strategy to increase production rates by more than 30% within three years of the combination and merger synergies;
- Kirkland Lake Gold Ltd's ("Kirkland Lake") acquisition of Detour Gold Corporation ("Detour") reflected the strategic importance of extending the reserve life of its portfolio. While the acquisition was principally a single-asset transaction for the Detour Lake mine (i.e. the flagship asset of Detour Gold), the mine had a number of attractive characteristics such as its scale (producing around 600koz gold per annum), stable mining jurisdiction (in Canada) and exploration upside (approximately 1,040 km² along the prospective Abitibi Greenstone Belt). Perhaps most importantly, the acquisition addressed a growing concern over the depletion of Kirkland Lake's ore reserves (estimated to be just under six

³ Both acquisitions implied 100% enterprise value of approximately \$1.5 billion and resource and reserve multiples of around 0.49 and 0.26, respectively.



GRANT SAMUEL



years). The acquisition more than doubled Kirkland Lake's ore reserves and extended its estimated reserve life by approximately 8 years (as Detour Lake had an implied reserve life of over 20 years); and

- Newcrest's acquisition of Pretium (Brucejack) was a strategic pivot to expand its operating footprint in North America and acquire an increasingly scarce combination of scale and high-grade gold reserves in "safe" jurisdictions. Brucejack is one of the highest grade operating gold mines in the world and is expected to have further potential exploration upside given the vast large mineral tenement holdings in the highly prospective Golden Triangle region (complementing Newcrest's existing footprint in the area through the Red Chris joint venture). In addition, there is potential to lift annual production rates within three years.

The remaining transactions occurred within a range of 6-8 times historical and forecast EBITDA. These transactions were amongst the largest in the history of the sector and include:

- the \$6 billion merger⁴ of Barrick and Randgold in 2018, which established Barrick as the largest gold producer in the world at the time (albeit only for a brief period). There are several factors that would suggest that a lower multiple was appropriate. The transaction was structured as a nil-premium merger following which Randgold shareholders accounted for approximately 35% of the combined group. One-third of the directors of the combined group will comprise appointees selected by Randgold. Moreover, Randgold primarily operated in jurisdictions with higher sovereign and jurisdictional risk (its two flagship assets are located in Mali and the Democratic Republic of Congo). Despite these factors, the implied EBITDA multiples were broadly in line with other transactions as they reflect Randgold's attractive portfolio of high grade gold assets and its track record of development and consistently growing production (increasing output for seven consecutive years through to 2017);
- Newmont's \$12.5 billion acquisition of Goldcorp in the following year, which enabled it to retake its position as the largest gold producer in the world. In some respects, the Goldcorp transaction terms mirrored the Barrick-Randgold merger (e.g. proportional shareholder composition of the combined group and Board representation). However, the transaction consideration was priced at a clear premium to Goldcorp shares. The value of the transaction consideration was further obscured by the following announcements leading up to the shareholder vote:
 - on 25 February, Barrick launched a hostile bid to acquire Newmont via a nil-premium merger;
 - on 11 March, Barrick withdrew its offer for Newmont and subsequently agreed to enter into a joint venture with Newmont for their Nevada operations (citing more than \$500 million pre-tax synergies per annum);
 - on 11 March, Newmont announced a material increase in identified synergies following the Goldcorp acquisition (from \$100 million to \$365 million per annum); and
 - on 25 March, Newmont announced a special dividend of \$0.88 per share to existing Newmont shareholders conditional upon approval of the Goldcorp acquisition.

While the price of Newmont shares (and, consequently, the implied value of the consideration) initially fell by over 10% in the days subsequent to the announcement, the share price recovered over the following two months as investors reacted to this series of announcements. As a result, the implied EBITDA multiples were largely unchanged in the days leading up to the shareholder vote (although the synergy-adjusted EBITDA multiples are substantially lower); and

- the \$6 billion sale of Yamana Gold Inc. ("Yamana") was the culmination of a competitive sale process and resulted in the sale of its:

⁴ Represents the implied enterprise value of Randgold based on the Barrick share price as at 23 September 2018 (the last day trading prior to the announcement of the merger).

Annexure 1. Independent Expert's Report

GRANT SAMUEL



- Canadian gold assets, which were acquired by Agnico Eagle Mines Limited ("Agnico Eagle") at an implied enterprise value of approximately \$2.5 billion; and
- Latin American copper-gold assets, which were acquired by Pan American Silver Corporation ("Pan American") at an implied enterprise value of approximately \$3.4 billion.

While the implied EBITDA multiples were broadly consistent for both portfolios (at or around 7.5 times historical EBITDA), the portfolios faced very different outlooks. The Canadian gold assets solely comprised Yamana's 50% interest in the Canadian Malartic joint venture and had an implied reserve life of only five years (albeit with a materially larger resource base and further exploration upside given its location in the Abitibi Gold Belt). On the other hand, the Latin American portfolio comprised four operating assets and several projects (in varying stages of development) that had a substantially larger exposure to other metals such as copper and silver.

In contrast, Agnico Eagle's merger with Kirkland Lake occurred at the bottom end of the range and was well below the implied multiples for the Detour Gold acquisition (which represented the majority of Kirkland Lake's production and ore reserves) that was completed just eighteen months earlier. The low EBITDA multiples likely reflected the lack of a control premium. Unlike other "merger of equals" transactions, the Kirkland Lake merger was arguably closer to a 50:50 split between the two businesses. Kirkland Lake shareholders collectively accounted for a 46% interest in the combined group. The Board of the combined group contained near-equal representation from both parties (i.e. seven directors from Agnico Eagle and six directors from Kirkland Lake). Key senior management executives (including the CEO) from Kirkland Lake were also retained. Collectively, these factors likely weighed on the implied EBITDA multiples for the merger.

RESOURCE AND RESERVE MULTIPLES

It is difficult to make conclusive observations on resource and reserve multiples. In some cases, high (or low) resource or reserve multiples are consistent with a high (or low) EBITDA multiple. In other cases, the multiples appear to contradict themselves (e.g. high EBITDA multiples corresponding with low resource or reserve multiples).

In any event, the implied multiples (excluding outliers) fall across a very wide range of:

- around \$120-270/oz of gold resources; and
- around \$230-500/oz of gold reserves.

Analysis of these metrics provides some useful observations that may not necessarily be obvious from a review of EBITDA multiples. In particular, transactions that have relatively higher resource and reserve multiples generally exhibit:

- significant exploration upside (or potential resource to reserve conversion). The very high reserve multiples implied by the Pretium (Brucejack) transaction reflect the low reserves to resource ratio, high grade nature of the deposit and also hinged on the near-mine and regional exploration upside in the Golden Triangle province. Similarly, the very high resource and reserve multiples implied by the Yamana transaction (particularly for the Canadian gold assets) reflected Agnico Eagle's track record of exploration success in the Abitibi Gold Belt and its ability to leverage its existing operating footprint in the region for any future development projects;
- a high degree of confidence in the near-term expansion strategy, as illustrated by the high resource and reserve multiples for the Saracen merger (consistent with its high EBITDA multiples); and
- shorter reserve lives, as the ore reserves are mined (and value is realised) over a shorter period than producers with longer mine lives. This likely impacted the resource and reserve multiples for Kirkland Lake (which are relatively high compared to its EBITDA multiples) whereas a producer with



GRANT SAMUEL



substantially longer reserve life such as Detour Gold had relatively low resource and reserve multiples compared to its EBITDA multiples.

On the other hand, transactions that have relatively lower resource and reserve multiples generally exhibit project uncertainty. The high EBITDA multiples implied by the acquisition of Red Chris stand in stark contrast to its low resource multiples (as a large amount of the block cave mineral resource was already recognised at the time). While the block cave expansion can potentially deliver a material earnings uplift, studies and project development at the time of transaction were still in nascent stages (e.g. the pre-feasibility study was not completed until two years later) and the capital expenditure was still to be incurred.

In theory, gold producers with higher exposures to other metals (e.g. copper) should be expected to have higher resource and reserve multiples (which are measured only on a contained gold basis). These other metals offer an additional source of revenue (and value) or by-product credits (i.e. negative costs) and can be material sources of value for some assets. However, the market evidence does not appear to clearly illustrate this distinction perhaps due to other factors weighing on the values of the producers. Goldcorp (long reserve life), Red Chris (project risks) and Yamana (development risk) all have large exposures to other metals such as copper and zinc (which are, in theory, exposed to more systematic risk) but have resource and reserve multiples that are broadly in line with the other transactions (most of which involved pure play gold producers).

3 Sharemarket Evidence

Despite the wave of sector consolidation that has resulted in the combinations of some of the largest gold producers, the gold sector remains highly fragmented. The ten largest gold producers (including Newcrest) represent a relatively small percentage of world production (estimated to be less than 30% global share⁵) with the balance accounted for by smaller scale gold producers with limited footprints (i.e. constrained by geography, reserve life and number of operating mines).

A large number of these gold sector participants are listed on international stock exchanges, including more than 20 entities that are listed on the ASX. However, these listed gold producers have vastly different operating and financial profiles that are not comparable to Newcrest. In this regard, Grant Samuel has considered but excluded from its analysis:

- junior ASX-listed gold developers, which play a crucial role in exploration and development of new gold deposits but have limited mining operations (e.g. Bellevue Gold Limited);
- junior ASX-listed gold producers, which do not have the same scale and operational diversity as major gold producers (e.g. Evolution Mining Limited, Regis Resources Limited, Ramelius Resources Limited, St Barbara Limited, Perseus Mining Limited);
- mid-sized gold producers, which operate at a much smaller scale (e.g. Alamos Gold Inc, B2Gold Corp) or lack the geographic diversity of major gold producers (e.g. Endeavour Mining plc); and
- large diversified gold producers that are primarily backed by government owned entities or individual investors and consequently have limited free float shares (e.g. PJSC Polyus, Zijin Mining Group).

Precious metal streaming companies (e.g. Wheaton Precious Metals Corporation, Royal Gold Inc., Franco-Nevada Corporation) have different business models that provide only an indirect exposure to gold through royalties. These companies have also been excluded from the analysis.

Accordingly, the analysis has been limited to a smaller subset of listed gold producers with the comparable scale and global presence to Newcrest.

⁵ Source: CRU Gold sector consolidation has a long way to go, February 2023.

Annexure 1. Independent Expert's Report

GRANT SAMUEL



In considering the sharemarket evidence, it should be noted that the multiples for the listed entities are based on share prices (and therefore do not include a premium for control) and that each of the comparable trading companies, with the exception of Northern Star, has a 31 December year end. The financial data has not been adjusted to align the year end for each company.

The following charts set out the historical and forecast EBITDA multiples (with production multiples illustrated as dots) as well as the resource and reserve multiples for these listed companies based on share prices at 31 August 2023:

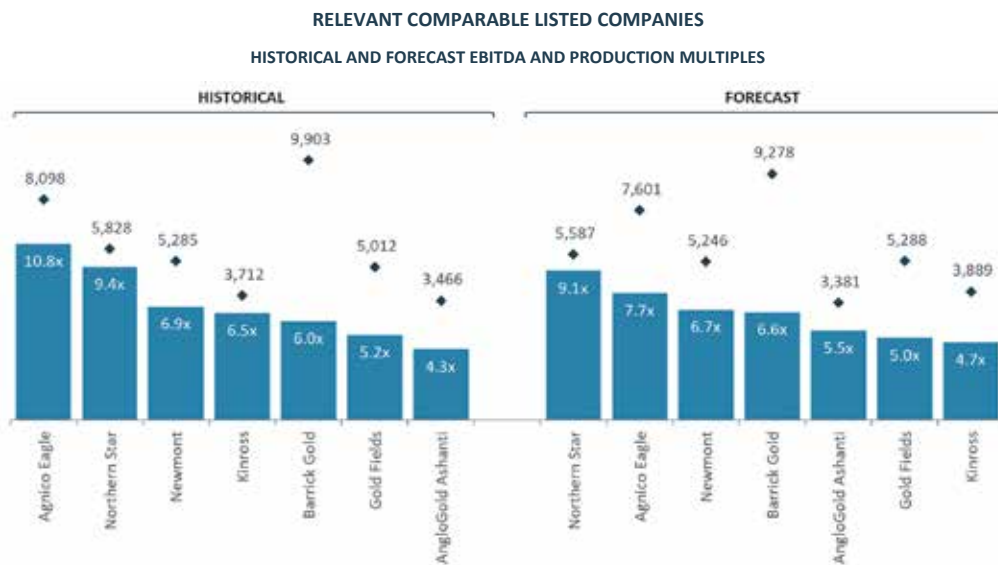

Source: Grant Samuel analysis^{2,6}

⁶ Enterprise values are typically adjusted for non-controlling interests and equity accounted investments. EBITDA is also typically adjusted to exclude income from equity accounted investments (where possible). A review of brokers forecasts indicates that many brokers do not separately forecast income from equity accounted investments (which is therefore included in forecast EBITDA). While this overstates EBITDA (and therefore the forecast EBITDA multiple), the impact is minimal as income equity accounted investments generally represent less than 15% of EBITDA for the comparable companies. Where sufficient information is available, blended multiples inclusive of these investments were calculated. This approach was taken for AngloGold Ashanti and Barrick Gold.

GRANT SAMUEL

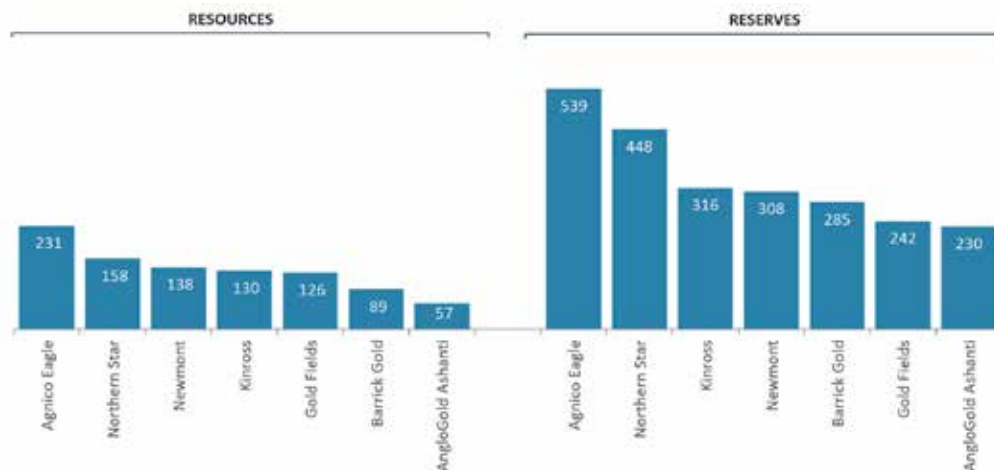
 RELEVANT COMPARABLE LISTED COMPANIES
 GOLD-ONLY RESOURCE AND RESERVE MULTIPLES (\$/OZ)

Source: Grant Samuel analysis^{2,6}

The large, diversified gold producers share a number of characteristics (e.g. >\$8 billion implied enterprise values, an international portfolio of producing gold assets, access to exploration and development opportunities and a predominantly unhedged exposure to gold). Their implied multiples sit across a very wide range (albeit with some level of consistency in trends across EBITDA multiples, production multiples and the resource and reserve multiples).

EBITDA AND PRODUCTION MULTIPLES

Agnico Eagle and Northern Star trade at higher multiples than their peers (i.e. at 9-11 times historical EBITDA (and 8-9 times forecast EBITDA). Their high multiples are supported by their:

- concentration in high quality mining jurisdictions (e.g. Australia and Canada);
- limited exposure to countries with higher geopolitical risks; and
- organic growth opportunities such as new developments and mine expansions (that are expected to have a large value impact relative to the size of the existing operations).

Agnico Eagle is the largest gold producer in Canada (which accounts for over 80% of revenues) and also operates several producing mines in Australia, Finland and Mexico. Its relatively high multiples are underpinned by the merger with Kirkland Lake and acquisition of Yamana's Canadian assets which consolidated its position as one of the world's largest gold producers particularly in Canada's Abitibi gold belt (where it now has five operating gold mines and two major exploration projects). The high multiples likely reflect the confidence in its organic growth strategy to unlock an additional 1Moz of gold production per annum by CY30 (a 30% increase over CY22 levels) through the optimisation of its regional infrastructure in the Abitibi region to support mine expansions (Canadian Malartic Complex) and future projects (Wasamac and Upper Beaver).

Northern Star is one of the largest gold producers in Australia (which accounts for over 85% of revenues) and also operates a gold mine in Alaska, United States. Despite its smaller size, partially hedged profile (around 20% of its three year forward production profile) and its concentration within Western Australia (i.e. Kalgoorlie and Yandal Operations), Northern Star trades at relatively high multiples due to its track record of production growth and reserve replacement (over 125 years of production at Kalgoorlie) as well as its low-risk organic growth strategy to reach 2Moz of gold production per annum by FY26 (a 25%

Annexure 1. Independent Expert's Report

GRANT SAMUEL



increase over FY22 levels). A number of the growth initiatives have already been completed but are yet to be reflected in earnings (or short term forecast earnings). Recent investments in new fleet at Kalgoorlie and mill expansions at Yandal and Pogo have unlocked incremental capacity. A mill expansion at Kalgoorlie recently reached FID and will be key to increasing production rates to meet Northern Star's production target.

The remaining gold producers trade in a reasonably tight range of around:

- 5.5-7.5 times historical EBITDA; and
- 5-7 times forecast EBITDA.

The bottom end of the range of implied EBITDA and production multiples is bookended by AngloGold Ashanti Limited ("AngloGold Ashanti"), Kinross Gold Corporation ("Kinross") and Gold Fields Limited ("Gold Fields"). These gold producers have large exposures to jurisdictions that are deemed to be "more risky":

- AngloGold Ashanti derives approximately 60% of production from Africa (the Democratic Republic of Congo, Ghana, Guinea and Tanzania) as well as nearly 20% of production from Brazil and Argentina;
- Kinross derives approximately 30% of production from Africa (particularly Mauritania) and has large mining operations in Brazil and Chile; and
- Gold Fields derives approximately 45% of production from Africa (particularly South Africa and Ghana), although the commissioning of the Salares Norte project in CY25 should allow it to diversify its production footprint into Chile.

The practical reality of the exposure to these "risky" jurisdictions is that some risks have translated into actual constraints to free cash flows in recent years. In 2021, more than \$900 million of AngloGold Ashanti's cash was locked up across a number of countries including the Democratic Republic of Congo (in relation to financial claims from the state-owned joint venture partner), Tanzania (in relation to a value added tax dispute) and Argentina (in relation to export duties). Some of these issues have since been resolved, but the outstanding sum continues to weigh on AngloGold Ashanti's implied multiples (equal to just under 5% of market capitalisation).

To reduce this discount to its peers, AngloGold Ashanti has announced a restructure to migrate its corporate headquarters to the United Kingdom and move its primary listing from the Johannesburg Stock Exchange (in South Africa) to the NYSE. The restructure is expected to attract greater liquidity in its shares by enhancing access to deeper pools of capital and also allow it to be domiciled in a lower risk jurisdiction. However, restructuring costs are expected to be substantial (5% of market capitalisation) and any value uplift appears likely to only arise in the medium term. The restructure remains subject to shareholder approval.

The relatively low multiples for Kinross are likely also impacted by its significantly higher financial risk than other peers (debt to EBITDA of around 2 times) and relatively high asset concentration in the Tasiast mine in Mauritania (which accounts for more than 25% of group production). The asset concentration became increasingly apparent following the divestment of its Russian assets in 2022 (which previously accounted for approximately 20% of group production).

The implied EBITDA multiples for the two largest gold producers, Newmont and Barrick Gold Corporation (Barrick Gold"), reflect a blend of the characteristics demonstrated by the gold producing peers that trade on both ends of the range. Accordingly both Newmont and Barrick Gold generally trade towards the middle of the range of their peers.

There are some arguments that support Newmont and Barrick Gold trading at similar multiples. Both have:

- diversified global operations across four continents with some exposure to other "future-facing" minerals (e.g. copper);



GRANT SAMUEL



- relatively long implied reserve lives (nearly 20 years);
- a shared interest in the Nevada Gold Joint Venture, which accounts for approximately 20% and 45% of their annual group gold production, respectively; and
- mature operations with limited growth upside from their existing operations (with group gold production expected to remain at around 6.0Moz per annum and 4.5Moz per annum for Newmont and Barrick, respectively).

However, Newmont has historically traded at a noticeable premium to Barrick Gold, probably reflecting the issues faced by Barrick Gold that also impact the implied multiples for AngloGold Ashanti, Kinross and Gold Fields such as:

- its substantial operating exposure to mining jurisdictions with higher sovereign risk (35% of CY22 production was attributable to Africa and another 15% from Dominican Republic and Argentina); and
- the challenging locations of its long-term growth projects, including in Papua New Guinea (restart of Porgera mine) and Pakistan (developing the Reko Diq copper-gold project).

The higher production multiples for Barrick Gold compared to Newmont reflects the higher EBITDA margins it generates (albeit at lower cash flow conversion ratios).

RESOURCE AND RESERVE MULTIPLES

In practice, it is typically difficult to assess resource and reserve multiples in isolation as they can vary across a very wide range and are also influenced by a large number of inputs and assumptions (many of which may not be consistently applied across mineral assets). There appears to be some consistency in resource and reserve multiples of around \$250-330/oz of gold reserves (albeit at a somewhat wider range of \$90-150/oz gold resources).

However, there are several outliers as well. Based on the sharemarket evidence at this point in time, the gold producers at the top end of the range demonstrate an attractive growth outlook with a clear path forward to execution. For example, the very high implied multiples for Agnico Eagle and Northern Star (which are outliers compared to most peers) likely reflect the credibility of their respective growth strategies (e.g. mill optimisation/expansion programs and brownfield exploration). Producers with a large exposure to other by-products such as copper also appear to trade towards the top end of the range as the copper credits from these producers can be meaningful contributors to earnings and value (although this does not always appear to be the case, as AngloGold Ashanti is trading at the bottom end of the range of resource and reserve multiples).

G R A N T S A M U E L



APPENDIX 6

SELECTION OF DISCOUNT RATE

1 Introduction

The valuation of an asset or business involves estimating the discount rates that may be utilised by potential acquirers of that asset in assessing the net present value of expected future cash flows. There is a body of theory from which models that generate a cost of capital have been developed but the selection of a discount rate is still fundamentally a matter of judgement.

Newcrest as a group is predominantly a gold producer at present albeit with a significant and growing copper exposure. In FY23, more than 75% of its revenues are derived from gold sales. Accordingly, most brokers and market commentators value Newcrest as a gold producer (i.e. using discount rates and beta estimates reflective of a gold producer). However, an individual valuation of each of Newcrest's mineral assets requires more scrutiny as individual mines are capable of being sold separately and their value should reflect their inherent characteristics. Some of its assets derive virtually all for their revenues from gold (e.g. Lihir, Brucejack and, to a lesser extent, Telfer). However, others have a different production profile with 50% or more of revenues derived from copper (e.g. Cadia, Red Chris and Wafi-Golpu). Accordingly, there is a question as to whether gold and copper production have different risk profiles and therefore warrant different discount rates.

This appendix examines the market evidence (particularly betas) for gold and copper producers and sets out Grant Samuel's conclusions as to appropriate discount rates for Newcrest assets.

The cash flows of Newcrest's mineral assets have been denominated in US dollars and discounted on the basis of rates appropriate for international capital markets. Given that many of the potential acquirers of the mineral assets of Newcrest are international mining companies, the assets are likely to be priced on the basis of costs of capital established in international capital markets.

2 Methodology

The discount rate selected represents an estimate of the weighted average cost of capital ("WACC") appropriate for these businesses based on a weighted average of the cost of the two primary funding sources, equity and debt. This is the relevant rate to apply to ungeared cash flows. There are three main elements to the determination of an appropriate WACC:

- cost of equity;
- cost of debt; and
- debt/equity mix.

The cost of equity has initially been derived, in the first instance, from application of the capital asset pricing model methodology. The CAPM is probably the most widely accepted and used methodology for determining the cost of equity capital.

The formula for deriving the cost of equity using CAPM is as follows:

$$R_e = R_f + \text{Beta} (R_m - R_f)$$

Where:

- Re = the cost of equity capital;
- Rf = the risk free rate;
- Beta = the beta factor;
- Rm = the expected market return; and



GRANT SAMUEL



$R_m - R_f$ = the market risk premium.

The beta for a company or business operation is normally estimated by observing the historical relationship between returns from the company or comparable companies and returns from the market in general. The market risk premium is estimated by reference to the actual long run premium earned on equity investments by comparison with the return on risk free investments.

The beta of an investment represents its systematic risk only. It is not a measure of the total risk of a particular investment. An investment with a beta of more than one is riskier than the market as a whole and an investment with a beta of less than one is less risky.

The formula conventionally used to calculate a WACC under a "classical tax system"¹ is as follows:

$$WACC = (R_e \times E/V) + (R_d \times (1-t) \times D/V)$$

Where:

- E/V = the proportion of equity to total value (where $V = D + E$);
- D/V = the proportion of debt to total value;
- R_e = the cost of equity capital;
- R_d = the cost of debt capital; and
- t = the corporate tax rate

3 Cost of Equity Capital

3.1 Risk Free Rate

Grant Samuel has adopted a risk free rate of 4.1%. The risk free rate approximates the yield to maturity on ten year United States Treasury Bonds in August 2023.

3.2 Market Risk Premium

Grant Samuel has consistently adopted a market risk premium of 6% and believes that this continues to be a reasonable estimate. It:

- is not statistically significantly different to the premium suggested by long term historical data;
- is similar to that used by a wide variety of analysts and practitioners as well as regulators (typically in the range 5-7%); and
- makes no explicit allowance for the impact of Australia's dividend imputation system.

3.3 Beta Factors

Gold Producers

The historical beta factors for a range of gold producers have been considered in determining an appropriate beta for Newcrest's mineral assets. They have been derived from several sources and calculated on two bases – relative to each company's home exchange index and relative to an international index (the aggregated world market for Barra and the MSCI for Bloomberg).

A summary of betas for selected listed major gold producers is set out in the table below:

¹ A tax system not featuring dividend imputation or other variants such as advance corporation tax (i.e. dividends are paid out of after tax income and are subject to full tax in the hands of investors).

Annexure 1. Independent Expert's Report

GRANT SAMUEL



EQUITY BETA FACTORS FOR SELECTED LISTED MAJOR GOLD PRODUCERS

	MARKET CAPITALISATION ² (\$ MILLIONS)	BARRA			ROZETTA ³	BLOOMBERG ⁴			
		HISTORICAL ⁵	PREDICTED ⁶			MONTHLY (4 YEARS)		WEEKLY (2 YEARS)	
			LOCAL BETA	GLOBAL BETA		LOCAL INDEX	MSCI ⁷	LOCAL INDEX	MSCI
Newcrest	15,681	0.79	1.08	1.14	0.76	0.83	0.80	0.88	0.64
GOLD PRODUCERS									
Agnico Eagle	25,916	0.65	1.01	0.97		0.98	0.84	1.03	0.61
AngloGold Ashanti	9,301	0.24	0.96	0.96		1.08	0.50	1.16	0.66
Barrick Gold	30,401	0.50	0.96	0.90		0.66	0.62	0.75	0.80
Goldfields	13,798	0.48	0.99	1.09		1.23	0.72	1.09	0.63
Kinross	6,131	1.01	1.16	1.14		1.15	0.92	1.28	0.81
Newmont	34,110	1.01	0.84	1.00		0.68	0.66	0.68	0.72
Northern Star	8,927	0.84	1.13	1.25	1.10	1.03	0.88	1.15	0.85
Median		0.65	0.99	1.00		1.03	0.72	1.09	0.72

Sources: Rozetta, Barra, Bloomberg

The table shows outcomes that clearly point towards a beta of less than 1.0 (and closer to 0.5 in the case of Barra and the two year Bloomberg calculations). This reflects gold's role as a "safe haven" asset that is not correlated with global activity. However, there are some challenges in determining a reliable beta for gold producers and for Newcrest:

- individual company betas fall:
 - in a very wide range, from 0.24 to 1.28;
 - can change materially over relatively short periods of time. As discussed in Section 4.2 of the Report, gold company betas have moved dramatically over the last 3.5 years. Historically, they have been close to zero but moved up substantially following the COVID-19 pandemic;
 - vary significantly depending on whether the local or world market index is utilised (e.g. Agnico Eagle and AngloGold Ashanti vary by 0.4 and 0.6 respectively); and
 - vary materially, depending on the data measurement source (Barra, Rozetta, or Bloomberg). Rozetta has two bases, one of which excludes the much quarter of 2020. Newcrest's beta on this basis is 0.91; and
- the historical betas measured:
 - against local indices are arguably less relevant for gold producers. They derive most (if not all) of their revenues in US dollars and betas are arguably impacted by currency movements. In any event, most of these companies (including Newcrest) have a substantial proportion of shares held by a wide variety of global investors; and

² Based on share prices as at 31 July 2023, except Newcrest which is based on its share price as at 3 February 2023 (being the day prior to the announcement of the Revised Proposal).

³ The Australian beta factors calculated by Rozetta as at 31 March 2023 over a period of 48 months using ordinary least squares regression or the Scholes-Williams technique where the stock is thinly traded.

⁴ Bloomberg betas have been calculated up to 31 July 2023. Grant Samuel understands that betas estimated by Bloomberg are not calculated strictly in conformity with accepted theoretical approaches to the estimation of betas (i.e. they are based on regressing total returns rather than the excess return over the risk free rate). However, in Grant Samuel's view the Bloomberg beta estimates can still provide a useful insight into the systematic risks associated with companies and industries. The figures used are the Bloomberg "adjusted" betas.

⁵ Historical beta factors calculated by Barra as at 31 July 2023 over a period of 60 months using ordinary least squares regression.

⁶ Barra predicted beta is a "fundamental" beta based on a multi-factor model, which regresses historical company returns against the returns of a market index using company-risk and industry-risk factors, re-estimated on a monthly basis, within the regression equation.

⁷ MSCI is calculated using local currency so that there is no impact of currency changes in the performance of the index.

GRANT SAMUEL



- by Barra are materially lower those measured by Rozetta or Bloomberg probably due to its longer measurement period (60 months) that covers a larger share of the pre-2020 period when betas were closer to zero (if not negative); and
- indicate no obvious difference in betas for gold producers that are “pure-play” gold producers compared to those that have some exposure to copper.

The beta of the ARCA index (vs the S&P 500) is approximately 0.7-0.8⁸.

Copper Producers

The historical beta factors for a range of copper producers and diversified miners that have a large copper exposure are set out below:

EQUITY BETA FACTORS FOR SELECTED LISTED COPPER PRODUCERS

	MARKET CAPITALIZATION ² (\$ MILLIONS)	BARRA			ROZETTA ³	BLOOMBERG ⁴			
		HISTORICAL ⁵	PREDICTED ⁶			MONTHLY (4 YEARS)		WEEKLY (2 YEARS)	
			LOCAL BETA	GLOBAL BETA		LOCAL INDEX	MSCI ⁷	LOCAL INDEX	MSCI
Newcrest	15,681	0.79	1.08	1.14	0.76	0.87	0.84	0.83	0.62
COPPER PRODUCERS									
Antofagasta	21,271	1.88	1.45	1.75		1.02	0.94	1.20	1.01
Capstone Copper	3,638	2.54	1.82	2.12		2.13	1.45	2.26	1.48
Ero Copper	2,230	1.92	1.56	1.77		1.73	1.59	1.62	1.16
First Quantum	20,404	2.15	1.69	1.90		1.66	1.52	2.02	1.33
Freeport-McMoRan	43,264	2.36	1.53	1.76		1.70	1.85	1.24	1.45
Hudbay Minerals	2,069	2.30	1.75	1.99		1.63	1.62	1.88	1.11
Lundin Mining	6,929	1.88	1.53	1.71		1.47	1.28	1.57	1.03
MMG Limited	3,163	1.33	1.09	1.32		1.54	1.76	1.46	0.89
Sandfire Resources	2,074	1.51	1.49	1.79	1.37	1.30	1.29	1.77	1.25
Taseko Mines	441	2.24	1.70	1.92		1.69	1.51	1.81	1.14
29Metals	234	1.54	1.66	2.07		1.43	0.86	1.53	0.92
Median		1.92	1.56	1.79		1.63	1.51	1.62	1.14
DIVERSIFIED MINING									
Anglo American	37,350	1.89	1.56	1.86		1.46	1.14	1.42	1.00
BHP	156,913	1.12	1.32	1.39		0.91	0.92	1.18	0.64
Glencore	75,266	1.44	1.36	1.53		1.62	1.23	1.19	0.74
Rio Tinto	112,034	1.01	1.27	1.36		0.67	0.69	1.04	0.63
South32	11,846	1.30	1.37	1.55		1.13	1.01	1.41	0.87
Teck Resources	23,145	1.67	1.51	1.65		1.08	1.22	0.81	0.94
Vale	63,257	1.22	1.14	1.35		1.05	1.17	0.74	0.84
Median		1.30	1.36	1.53		1.08	1.14	1.18	0.84

¹Source: Rozetta, Barra, Bloomberg

The observed betas for copper producers have similar issues to gold producers:

- individual company betas:
 - fall in a very wide range, from 0.86 to 2.54
 - vary significantly depending on whether the local or world market index is utilised (e.g. Hudbay Minerals varies by up to 0.8); and

⁸ Bloomberg, four-year basis.

Annexure 1. Independent Expert's Report

GRANT SAMUEL



- vary materially, depending on the data measurement source (Rozetta, Bloomberg or Barra);
- vary depending on the time period for measurement. Four year and two year Bloomberg betas can be different by up to 0.9 (MMG);
- Rozetta's observed beta for the entire metals and mining industry is 1.1 but this is heavily influenced by the large diversified miners; and
- gearing levels vary significantly but this is not always consistent with beta factors.

Nevertheless, the table clearly shows substantially higher beta factors for copper focussed producers compared to gold producers (or diversified miners).

Most large diversified mining companies have historical betas closer to (and at times below) 1.0. Intuitively, this would make sense given their global operations and scale (in most cases) as well as their diversified commodity profiles which insulate these producers from one-off impacts from any one of their operations.

Conclusion

On the basis of the evidence presented above and notwithstanding the limitations of the data, it would not be unreasonable to estimate betas of:

- 0.5-0.6 for gold producers. While some of the current evidence suggests a higher rate, Grant Samuel is also cognisant of the lower betas over the past two decades; and
- 1.1-1.3 for copper producers.

4 Market Evidence on Gearing

In determining an appropriate debt/equity mix, regard was had to gearing levels of Newcrest and the peer group companies used in the beta analysis.

Gearing levels (based on market values) for gold companies for the past five years have generally been very low and broadly in line with the gearing levels for diversified miners (albeit lower than copper producers):

GEARING LEVELS FOR SELECTED LISTED MAJOR GOLD PRODUCERS AND COPPER PRODUCERS

	NET DEBT/(NET DEBT + MARKET CAPITALISATION) ⁹							
	FINANCIAL YEAR ENDED					CURRENT ¹⁰	4 YEAR AVERAGE	5 YEAR AVERAGE
	HISTORICAL 5	HISTORICAL 4	HISTORICAL 3	HISTORICAL 2	HISTORICAL 1			
Newcrest	10.1%	6.7%	9.6%	1.4%	2.2%	9.7%	5.0%	6.0%
GOLD PRODUCERS								
Agnico Eagle	8.7%	11.6%	6.8%	8.2%	2.8%	6.1%	7.3%	7.6%
AngloGold Ashanti	33.7%	20.4%	10.5%	10.9%	13.3%	12.4%	13.8%	17.7%
Barrick Gold	24.8%	11.3%	2.7%	0.0%	(2.3%)	1.3%	2.9%	7.3%
Goldfields	31.7%	28.8%	9.7%	11.2%	9.3%	4.9%	14.7%	18.1%
Kinross	14.5%	21.7%	8.8%	8.3%	30.2%	24.8%	17.3%	16.7%
Newmont	4.0%	13.8%	4.3%	2.2%	4.2%	7.2%	6.2%	5.7%
Northern Star	(10.7%)	(2.7%)	1.2%	1.0%	(0.7%)	2.8%	(0.3%)	(2.4%)
Median	14.5%	13.8%	6.8%	8.2%	4.2%	6.1%	7.3%	7.6%

⁹ Net debt is inclusive of lease liabilities.

¹⁰ Current gearing levels are based on the most recent balance sheet information and on sharemarket prices as at 31 July 2023, except Newcrest which is based on its share price as at 3 February 2023 (being the last trading day prior to the announcement of the Revised Proposal).

GRANT SAMUEL



GEARING LEVELS FOR SELECTED LISTED MAJOR GOLD PRODUCERS AND COPPER PRODUCERS (CONT)

	NET DEBT/(NET DEBT + MARKET CAPITALISATION) ⁹							
	FINANCIAL YEAR ENDED					CURRENT ¹⁰	4 YEAR AVERAGE	5 YEAR AVERAGE
	HISTORICAL 5	HISTORICAL 4	HISTORICAL 3	HISTORICAL 2	HISTORICAL 1			
COPPER PRODUCERS								
Freeport-McMoRan	23.0%	32.0%	31.1%	5.7%	3.4%	4.2%	18.0%	19.0%
Antofagasta	5.7%	4.4%	2.3%	(3.5%)	3.4%	4.0%	1.6%	2.5%
First Quantum	38.3%	57.4%	60.8%	35.4%	34.5%	25.3%	47.0%	45.3%
Lundin Mining	(36.7%)	(22.9%)	5.0%	(2.3%)	(12.0%)	3.1%	(8.1%)	(13.8%)
Capstone Copper	36.1%	47.3%	34.4%	(9.5%)	12.2%	20.7%	21.1%	24.1%
MMG Limited	60.8%	75.4%	78.3%	57.4%	67.7%	62.1%	69.7%	67.9%
Sandfire Resources	(25.7%)	(30.5%)	(46.7%)	(87.1%)	21.2%	15.7%	(35.8%)	(33.8%)
Hudbay Minerals	31.3%	30.9%	44.9%	33.8%	49.7%	33.2%	39.8%	38.1%
Ero Copper	18.2%	7.3%	11.5%	1.4%	(0.3%)	10.5%	5.0%	7.6%
29Metals	nm	nm	nm	11.1%	0.4%	18.9%	5.8%	5.8%
Taseko Mines	52.8%	68.4%	60.5%	32.2%	46.7%	47.0%	52.0%	52.1%
Median	27.1%	31.4%	32.7%	5.7%	12.2%	18.9%	18.0%	19.0%
DIVERSIFIED MINING								
BHP	8.4%	7.0%	10.9%	3.3%	0.5%	4.3%	5.5%	6.0%
Rio Tinto	4.7%	4.5%	4.5%	(2.5%)	(1.1%)	3.1%	1.4%	2.0%
Glencore	33.2%	43.5%	54.9%	35.3%	27.9%	26.7%	40.4%	39.0%
Vale	10.6%	9.3%	20.2%	3.7%	8.4%	18.1%	10.4%	10.4%
Anglo American	20.4%	21.9%	48.5%	36.1%	24.5%	21.6%	32.8%	30.3%
Teck Resources	(17.8%)	(4.9%)	(4.4%)	(4.2%)	(4.6%)	2.5%	(4.5%)	(7.2%)
South32	9.5%	8.2%	15.6%	3.5%	4.5%	11.2%	7.9%	8.2%
Median	8.4%	7.0%	10.9%	3.3%	0.5%	4.3%	5.5%	6.0%

Source: Company Reports, IRESS, S&P Global Market Intelligence, Bloomberg, Grant Samuel analysis

The gearing of gold producers is uniformly low. Copper producers are much more variable but generally are still relatively low. Having regard to the above, the debt/equity mix has been assumed to be 5-10% debt for gold producers and 10-15% debt for copper producers. This is regarded as being broadly consistent with the beta factors.

5 Cost of Debt

An assumed cost of debt of 6% implies a margin of 190 basis points over the risk free rate. This margin reflects:

- Grant Samuel's understanding of current market margins that Newcrest is achieving (on average across a range of markets and maturities, including the most recent bank debt refinancing in June 2022) as well as that of other investment grade peers;
- recent spreads for US dollar denominated BBB corporate bonds over US Treasury yield curve published by the Federal Reserve Bank of St. Louis, which ranged from 170-200 basis points in CY23 to-date and are currently at around 172 basis points; and
- the cost of liquidity. For example, Newcrest is carrying cash of over \$580 million and undrawn bank debt facilities of nearly \$1.7 billion as at 30 June 2023.

Annexure 1. Independent Expert's Report

GRANT SAMUEL



6 Calculated WACCs

6.1 Cost of Equity

Using the assumptions set out above together with the beta factor results calculated, the cost of equity as follows:

NEWCREST - COST OF EQUITY CAPITAL

	LOW	HIGH
Formula	$Re = Rf + \text{Beta} (Rm - Rf)$	
<i>Gold producers</i>	= 4.1% + (0.5 x 6.0%) = 7.1%	= 4.1% + (0.6 x 6.0%) = 7.7%
<i>Copper producers</i>	= 4.1% + (1.1 x 6.0%) = 10.7%	= 4.1% + (1.3 x 6.0%) = 11.9%

6.2 WACC

On the basis of the parameters outlined above and assuming a corporate tax rate of 30%, the nominal WACC for gold producers is in the range 6.6-7.4% and for copper producers is in the range 9.4-10.9%:

NEWCREST - CALCULATED WACC

	LOW	HIGH
Formula	$= (Re \times E/V) + (Rd \times (1-t) \times D/V)$	
<i>Gold producers</i>	= (7.1% x 90%) + (6% x 70% x 10%) = 6.4% + 0.4% = 6.8%	= (7.7% x 95%) + (6% x 70% x 5%) = 7.3% + 0.2% = 7.5%
<i>Copper producers</i>	= (10.7% x 85%) + (6% x 70% x 15%) = 9.1% + 0.6% = 9.7%	= (11.9% x 90%) + (6.0% x 70% x 10%) = 10.7% + 0.4% = 11.1%

7 Selection of Discount Rate for Newcrest Assets

Having regard to the analysis set out above Grant Samuel has selected nominal discount rate ranges of:

- 6.5-7.5% for Lihir, Brucejack and Telfer where the vast majority of production is gold; and
- 8-9% for gold assets with large exposures ($\geq 50\%$) to copper (i.e. Cadia, Red Chris and Wafi-Golpu). This rate is approximately midway between the calculated gold and copper producer discount rates (i.e. it is a blended rate).

While this may not necessarily be the standard market practice adopted by brokers and analysts (who generally adopt a binary approach in valuing gold companies — the entity is either a “gold company” or a “copper company”), Grant Samuel believes this approach best reflects the individual characteristics of Newcrest’s mineral assets.

It recognises that, even if the cash flows from the two minerals (gold and copper) cannot be segregated, the combined cash flow streams have very different risk profiles (underpinned by the clearly different historical beta factors of producers). The CAPM methodology has so many limitations (including, not least, the statistical unreliability of the data and its backward looking nature) that to attempt to develop more finely differentiated estimates would involve “*the meaningless pursuit of spurious precision*”¹¹. Ultimately, the selection of discount rates is a subjective judgement and should be considered in that context.

¹¹ See G. Partington and S. Satchel “*Issues in releveraging beta and testing for structural breaks*” September 2017



GRANT SAMUEL



Specific risks such as sovereign risk (Lihir and Wafi-Golpu) and development risk (Red Chris and Wafi-Golpu) have been separately taken into account by “risking” (i.e. discounting) the NPV outputs generated by applying the discount rates set out above.

G R A N T S A M U E L



APPENDIX 7

BACKGROUND TO THE GOLD FUTURES METHODOLOGY

1 Background

Theoretical valuation methodologies such as the DCF methodology are based on the premise that the value of an asset or project can be estimated by identifying a portfolio of financial assets of similar cash flow and risk characteristics and extrapolating the value of that portfolio. The DCF methodology assumes that the appropriate analogous asset portfolio is a portfolio of riskless bonds and increases the discount rate to adjust for the additional risks involved in real assets.

It is not clear that conventional DCF methodology is the only appropriate methodology for valuing gold mining projects. There is a body of argument that suggests that the analogous asset portfolio for gold projects is a portfolio comprised of bonds and gold or bonds and futures contracts over gold. Valuation models which attempt to incorporate the value of management flexibility assume that a mining project may be viewed as a portfolio of complex options over the commodity being mined. However, such an analysis increases practical complexities substantially. This Appendix discusses the valuation of gold projects on the basis that the value of gold projects may be estimated by reference to the value of asset portfolios consisting of bonds and either gold futures or physical gold.

The limitations of the conventional DCF methodology for valuing gold assets may be a consequence of the fact that gold is not a commodity. Rather, it is commonly viewed as a financial asset. Through the gold futures market, it is possible to earn returns on gold commensurate with the returns on low risk financial instruments.

2 Approach

The valuation of gold projects by reference to the gold futures market (i.e. the "gold futures methodology") is an alternative approach to a conventional DCF analysis.

The gold futures market can provide a precise measure of the present value of gold delivered at some time in the future. A gold futures contract is a contract to buy and sell a quantity of gold for a specified price (the "futures price") to be delivered at some point in the future. The present value of the future gold delivery is given by the futures price discounted at the risk free rate for the period to delivery of the gold.

Valuation of a gold project requires the subtraction of the present value of future extraction costs from the present value of future gold production. Future gold production may be represented as a series of expected gold deliveries. Expected gold deliveries are defined as the mean of all probability adjusted gold deliveries. These expected gold deliveries can be valued by reference to the relevant futures prices, discounted at the risk free rate. This does not represent an attempt to estimate actual future gold revenues. Rather, it is a means of estimating the current value of future gold production. It is argued that it is appropriate to use the risk free rate to value future production because:

- all gold price risk has been taken into account through the use of futures prices;
- development, mining and related risks have been taken into account by using expected future gold production. Expected future gold production represents risk adjusted future gold production; and
- other risks associated with gold revenues should be fully diversifiable. Accordingly, diversified portfolio investors would require no return above the risk free rate.

Use of the risk free rate does not suggest that the cash flows from any asset are certain or risk free. It implies only that the cash flows are not subject to any systematic risk. Therefore, given that all specific



GRANT SAMUEL



(non systematic) risks can be diversified away on a portfolio basis, it is appropriate to apply the risk free rate.

Consequently, the present value of a gold mining project is given by the present value of future production less the present value of future extraction costs. This may be represented as follows:

$$PV = \sum \frac{P_t \times F_t}{(1 + Rf)^t} - \sum \frac{C_t}{(1 + Rf)^t}$$

where:

PV = present value of the gold mine given by summing the present value for future production less the present value of future costs;

F_t = gold futures price for delivery in each future period *t*;

P_t = expected production in each period *t*;

C_t = expected extraction cost in each period *t*; and

Rf = the risk free rate for duration *t*.

Gold producers are frequently unable to write gold futures contracts for more than five years. For valuation purposes, however, gold futures prices can be estimated for longer periods. Gold futures prices may be estimated by compounding the current spot price at the risk free rate for the period of the futures contract. This may be represented as follows:

$$F_t = S_0(1 + Rf)^t$$

where:

S₀ = spot gold price at time 0

This simplifies the earlier present value for a gold mine to the following:

$$PV = \sum P_t \times S_0 - \sum \frac{C_t}{(1 + Rf)^t}$$

Accordingly, gold projects may be valued by valuing expected future gold production at the current spot gold price, without discounting, and subtracting expected future extraction costs (including by-product credits) discounted at the risk free rate.

Gold producers typically achieve a contango (the premium to the current spot price) through the futures market that is somewhat less than the current spot price compounded at the risk free rate. This discount reflects counterparty or credit risk and transaction costs. As between credit risk free counterparties, the gold futures price should always be equal to the current spot price compounded at the risk free rate. If the gold futures price was less than the current spot price compounded at the risk free rate, holders of gold could lock in infinite risk free profits. They could sell their gold, invest the amount realised in risk free bonds and buy back the equivalent volume of gold in the futures market at a price less than the proceeds and accumulated interest from their bond holdings. Conversely, if the gold futures price was greater than the current spot compounded at the risk free rate, infinite risk free profits could be secured by selling bonds (or borrowing), buying gold in the spot market, delivering the gold into futures contracts and repurchasing the bonds.

Gold producers are not risk free counterparties. However, for the purpose of valuing expected future gold production, it is assumed that the futures price is given by the current spot price compounded at the risk free rate. Counterparty and other diversifiable risks are taken into account through the process of estimating expected future production, which represents risk-adjusted production.



GRANT SAMUEL



3 Limitations

The gold futures methodology also has limitations and does not necessarily reconcile to market prices. It assumes that there is a consistent relationship between share market and transaction values for gold companies and the value of physical gold. However, this may not necessarily be true in all cases due to the:

- changing risk profile of gold.** Gold has historically been viewed as a financial instrument with limited systematic risk (i.e. zero betas). As discussed above, recent movements in the gold price appear to be inconsistent with it being an effective hedge against inflation and economic uncertainty. Gold prices fell amidst the market turmoil of early 2020 and rebounded amongst with the rest of the stock market in the months that followed. Its performance in 2022 also appeared to mirror the stock market as it drifted downwards (along with the stock market) following the start Russia-Ukraine War; and
- fluctuations in the relative performance between gold prices and gold equities.** While the relative performance has generally been broadly consistent for most of the past ten years, there have also been sustained periods of dislocation:

NYSE ARCA GOLD MINERS INDEX VS SPOT GOLD PRICE
JANUARY 2014 TO JULY 2023



Source: Bloomberg

Some of this can be explained by the “leveraged” exposure gold producers have to gold prices given their operating leverage (production costs do not change in line with the gold price so the impact of price changes on a producer’s net margin is accentuated). Gold equities can (and should) outperform physical gold in times of increasing gold prices and vice versa.

In any event, the share prices for gold equities can be impacted by specific issues such as operational issues, capital expenditures and regulatory changes.

There is clear evidence that the relationship can have periods of dislocation (shaded in red):

HISTORICAL REGRESSION COEFFICIENTS - NYSE ARCA GOLD MINERS INDEX VS SPOT GOLD PRICE

	CY14	CY15	CY16	CY17	CY18	CY19	CY20	CY21	CY22	CY23 YTD	10-YEAR AVERAGE
Regression coefficient	0.84	0.87	0.86	0.18	0.75	0.95	0.88	0.49	0.93	0.74	0.75

Source: Bloomberg



GRANT SAMUEL



Moreover, there are some other issues that are particularly relevant for Newcrest's mineral assets that the gold futures methodology does not effectively capture, including:

- the nature of the jurisdictions. From the perspective of an international investor in gold companies, a mine with the same set of characteristics (e.g. reserve life, grades, operating costs) is likely to be less attractive if it was located in a less transparent and stable jurisdiction such as Papua New Guinea compared to one that was located in "safer" jurisdictions such as Australia or North America;
- development risks. While the gold futures methodology accounts for some discount to value to reflect the time value of money before a development or major mine expansion is completed, an international investor is likely to apply a higher risk-weighting (or a discount) to projects that are exposed to development risks (e.g. construction, budget, timing, ramp-up);
- industrial metals such as copper. While gold price risk has been taken into account through the use of futures prices, copper price risk may not be fully accounted for. Newcrest derives more than 35% of its revenues from copper sales. This exposure is particularly concentrated in three assets — Cadia, Red Chris and (the currently undeveloped) Wafi-Golpu. While the gold futures methodology assumes that non-systematic risks can be diversified away in a portfolio, this assumption becomes potentially untenable when gold accounts for only an increasingly smaller proportion of the production profile; and
- value of long reserve lives. Investors may be applying more significant discounts to long dated production to account for unspecified risks that could result in production ultimately falling short of reserves. For example, an investor may be prepared to value in full only the first (say) 15 or 20 years of production from a mine. Mines with very long expected lives may be particularly affected by this treatment of risk.

Individually (and more so collectively), these issues can overstate the value of gold assets under a gold futures methodology.

4 Conclusions

The valuation of gold projects by reference to the gold futures market does not reflect general practice but has been utilised by Grant Samuel in the past. This approach has a strong theoretical underpinning and has, at times, been a reliable predictor of value as its conclusions were consistent with common market rules of thumb for valuing gold producers and gold projects (e.g. quantity of gold in reserves and resources).

However, there are some genuine challenges to its predictive power in the current market environment especially for Newcrest's mineral assets which each face one or more of the issues noted above. There is a real likelihood that value may be overstated. Accordingly, Grant Samuel has considered the gold futures methodology in its analysis but, given the current limitations, has not explicitly relied on it or directly utilised it in determining the valuation ranges for each of Newcrest's mineral assets.



Annexure 1. Independent Expert's Report

APPENDIX 8
TECHNICAL SPECIALIST REPORT BY
AMC CONSULTANTS PTY LTD



AMC Consultants Pty Ltd
ABN 58 008 129 164

Level 1, 1100 Hay Street
West Perth WA 6005
Australia

T +61 8 6330 1100
E perth@amcconsultants.com
W amcconsultants.com



Report

Newcrest - Independent Technical Specialist's Report Grant Samuel & Associates Pty Ltd

AMC Project 0223041
7 September 2023

Unearth a smarter way

Annexure 1. Independent Expert's Report

Newcrest - Independent Technical Specialist's Report

Grant Samuel & Associates Pty Ltd

0223041

07 September 2023

The Directors
Grant Samuel & Associates Pty Ltd
Level 19, Governor Macquarie Tower, 1 Farrer Place
Sydney NSW 2000 Australia

Dear Sirs

Newcrest Mining Limited Independent Technical Specialist's Report

Newcrest Mining Limited (Newcrest) advised in its Market Release dated 15 May 2023 that it had entered into a binding scheme implementation deed with Newmont Corporation (Newmont) in relation to a proposal for Newmont to acquire 100% of the issued shares in Newcrest by way of a scheme of arrangement (Newmont Transaction).

Grant Samuel & Associates Pty Ltd (Grant Samuel) advised AMC Consultants Pty Ltd (AMC) that:

- Newcrest engaged Grant Samuel to prepare an independent expert's report (IER) in relation to the Newmont Transaction.
- Grant Samuel required technical advice in relation to its preparation of the IER and an independent technical specialist's report (ITSR) to accompany the IER.

Accordingly, Newcrest engaged AMC to provide technical advice to Grant Samuel and prepare the ITSR concerning the mineral assets of Newcrest (Mineral Assets).

As instructed by Grant Samuel, the scope of ITSR consists of:

- AMC's description of the Mineral Assets.
- AMC's review of Newcrest's estimates of Mineral Resources and Ore Reserves.
- AMC's review of the estimates of production profiles, capital expenditure, and operating costs for significant producing and development Mineral Assets for which life-of-mine plans are provided by Newcrest.
- AMC's production and development scenarios for the purposes of value modelling by Grant Samuel for certain components of the Mineral Assets noting that:
 - The scenarios vary depending upon the specific issues relating to each asset and may be based on extensions to current estimates of Mineral Resources and Ore Reserves and/or the potential for variations in future production rates.
 - AMC and Grant Samuel worked together to jointly specify and define the scenarios for each relevant asset.
- AMC's valuations of Newcrest's Mineral Resources not included in the production and development scenarios, and Newcrest's exploration properties and other early-stage development assets for which life-of-mine plans have not been provided by Newcrest.
- The valuation date is 30 June 2023.

AMC's production and development scenarios and valuations as referred to in this letter and described in the ITSR are presented on a 100% basis, noting that Newcrest does not hold 100% of some of the Mineral Assets.

Figures I and II present the locations of the Mineral Assets.

The ITSR is attached to this letter and is to be read in conjunction with this letter.

Newcrest - Independent Technical Specialist's Report

Grant Samuel & Associates Pty Ltd

0223041

Executive Summary

Mineral Assets

The Mineral Assets are:

- Cadia - operation – New South Wales, Australia
 - 100% Newcrest.
 - Copper, gold.
 - Underground panel-cave mining.
- Telfer - operation and Havieron - development project, Western Australia, Australia
 - Telfer - 100% Newcrest.
 - Telfer - gold, copper.
 - Telfer - open pit and underground mining.
 - Havieron - 70% Newcrest.
 - Havieron – feasibility study in progress for underground mining with transport of ore to Telfer for processing.
 - Havieron decline development underway.
- Lihir - operation - Aniolam Island, Papua New Guinea
 - 100% Newcrest.
 - Gold.
 - Open pit mining.
- Red Chris - operation - British Columbia, Canada
 - 70% Newcrest.
 - Gold, copper.
 - Open pit mining.
 - Block cave feasibility study in progress and due for completion in the second half of calendar year ending 31 December 2023.
- Brucejack - operation - British Columbia, Canada
 - 100% Newcrest.
 - Gold, silver.
 - Underground mining.
- Wafi-Golpu - development project - Morobe Province, Papua New Guinea
 - 50% Newcrest.
 - Gold, copper.
 - Open pit and underground mining.
 - Environmental permit issued 2020.
 - Framework development MOU signed with PNG government 2023.
- Namosi - exploration project – Namosi Province, Fiji
 - 73% Newcrest.
 - Gold, copper.
 - Open pit mining.
- Newcrest joint ventures and 100%-owned exploration projects
 - Exploration projects adjacent to Red Chris and Brucejack operations in British Columbia, referred to as the Golden Triangle and Boomerang.
 - Exploration projects adjacent to Cadia, referred to as the Junction Reefs.
 - Northern Territory early-stage gold exploration project
- Newcrest earn-ins
 - Nevada exploration project in the Great Basin referred to as Appaloosa.

Annexure 1. Independent Expert's Report

Newcrest - Independent Technical Specialist's Report

Grant Samuel & Associates Pty Ltd

0223041

- Oregon and Nevada early-stage gold exploration projects referred to as Lodestar, Midas North, Mahogany, and Spring Peak.
- Queensland early-stage gold exploration project.
- Exploration projects in the Paterson region of Western Australia.
- Exploration earn-in with Lundin Gold Inc in Ecuador.

Figures I and II present the locations of the Mineral Assets.

Figure I Mineral Assets in the Asia-Pacific region

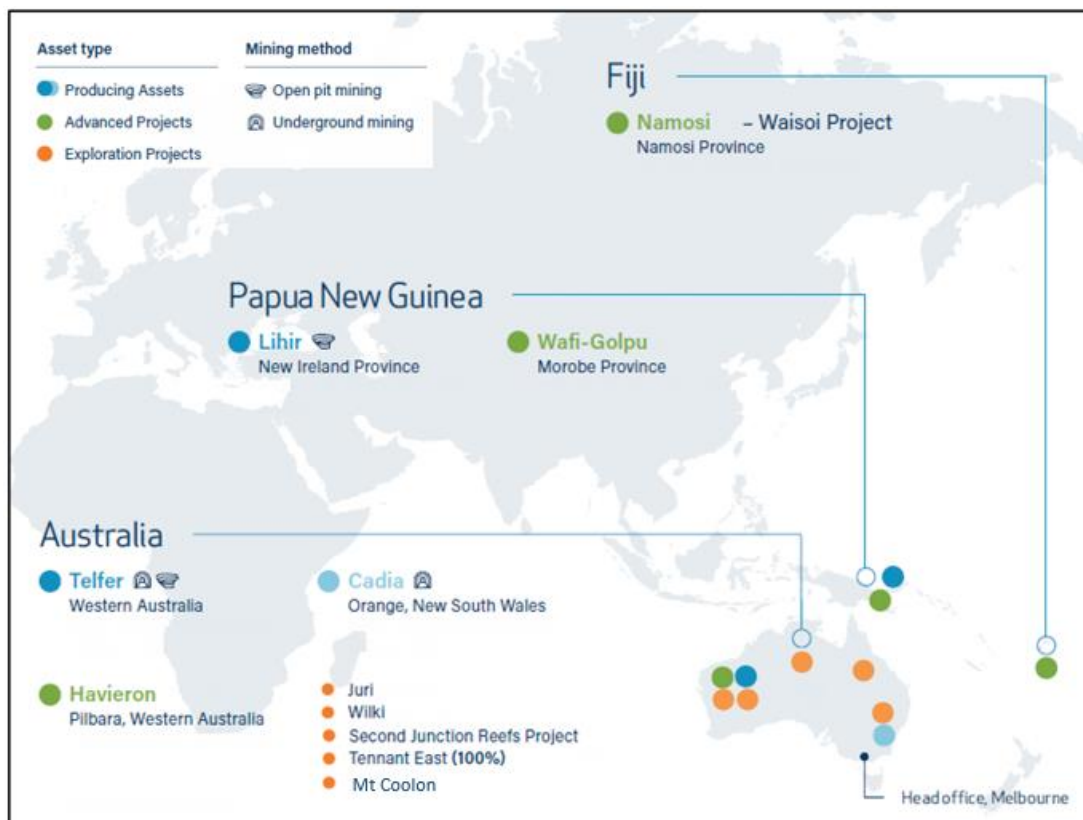

Newcrest - Independent Technical Specialist's Report

Grant Samuel & Associates Pty Ltd

0223041

Figure II Mineral Assets in the Americas region

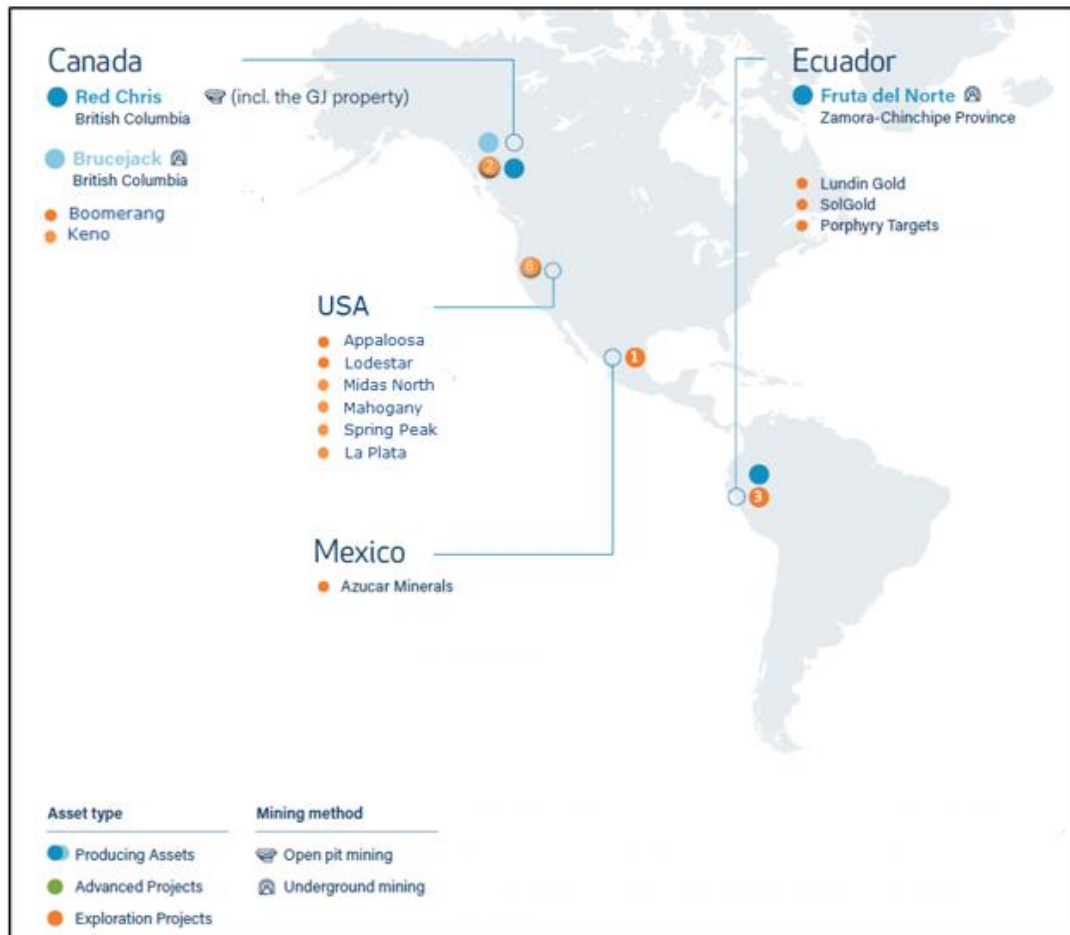

Newcrest reports that it has investments (Investments) in:

- The Fruta del Norte gold operation located in the province of Zamora-Chinchipe, Ecuador through its equity interest in Lundin Gold Inc.
- The Cascabel copper-gold project located in the province of Imbabura, Ecuador through its equity interest in Solgold plc
- The El Cobre copper-gold project located in the state of Veracruz, Mexico through its equity interest in Azucar Minerals Ltd
- Exploration projects in the state of Western Australia, Australia through its equity interest in Antipa Minerals Ltd
- Gold, copper and silver exploration assets in Colorado, USA and the Yukon, Canada through its equity interest Metallic Minerals Corp.
- The Mahogany gold project in Oregon, USA and the Lodestar, Midas North, and Spring Peak gold projects in Nevada, USA through its earn-in agreement with Headwater Gold Inc.

Grant Samuel instructed AMC that the scope of the ITSR was not to cover the Investments because Grant Samuel did not require input from AMC for its assessments of the Investments.

Newcrest - Independent Technical Specialist's Report

Grant Samuel & Associates Pty Ltd

0223041

AMC's engagement

In providing technical advice to Grant Samuel and preparing the ITSR, AMC:

- Has taken instruction from and reported to Grant Samuel.
- Has been provided with technical information by Newcrest for the purposes of the assignment.
- Has limited its review of operating costs to site-based costs.
- Has not reviewed State or third-party royalties, taxes, concentrate transport charges, and smelting and refining charges.
- Has been indemnified by Newcrest against actions arising from the assignment:
 - Other than those arising from actions taken or omitted to be taken by AMC illegally, in bad faith, or resulting from gross negligence, recklessness, fraud or material breach of the engagement as agreed.
 - As a result of use by AMC of information provided by the Newcrest or its representatives that is false, misleading, or incomplete in a material respect.
- Is being paid a fee by Newcrest according to its normal per diem rates which is not contingent on the outcome of the Newmont Transaction.

VALMIN Code

AMC has prepared this letter and the ITSR attached to this letter as a Specialist in accordance with the VALMIN Code¹.

JORC Code

In this letter and the ITSR attached to this letter, AMC's use of the terms Mineral Resources and Ore Reserves are in accordance with the JORC Code².

ASIC Regulatory Guides

AMC has prepared this letter and the ITSR attached to this letter in compliance with the requirements of the Australian Securities & Investments Commission (ASIC) Regulatory Guide 111 (Content of expert reports) and Regulatory Guide 112 (Independence of experts).

AMC's independence

AMC has undertaken several technical consulting assignments on some components of the Mineral Assets for Newcrest or related companies. In all the assignments, AMC acts as an independent party and has no pecuniary interest in the performance of the Mineral Assets or the outcome of the Newmont Transaction.

¹ Australasian Code for Public Reporting of Technical Assessments and Valuations of Mineral Assets, The VALMIN Code, 2015 Edition. Prepared by the VALMIN Committee of the Australasian Institute of Mining and Metallurgy (AusIMM) and Australian Institute of Geoscientists (AIG). Effective 30 January 2016. Mandatory for AusIMM and AIG members from 1 July 2016.

² Australasian Code for Reporting of Exploration Results, Mineral Resources and Ore Reserves, The JORC Code 2012 Edition. Prepared by the Joint Ore Reserves Committee of the Australasian Institute of Mining and Metallurgy, Australasian Institute of Geoscientists and Minerals Council of Australia (JORC). Effective 20 December 2012 and mandatory from 1 December 2013.

Newcrest - Independent Technical Specialist's Report

Grant Samuel & Associates Pty Ltd

0223041

AMC's consulting assignments for Newcrest can be described as:

- Geotechnical assessments and reviews.
- Benchmarking of operational costs and performance.
- Assistance with mine planning at some operations.
- Staff secondments to various operations.
- Technical reviews of certain estimates of Mineral Resources and Ore Reserves.
- Review and design of underground backfill and related hazard assessments.

AMC does not consider that any of its Newcrest assignments constitute development of material primary studies that would define life-of-mine plans for any of the Mineral Assets.

AMC has also undertaken various technical consulting assignments for Newmont, some of which are ongoing.

For all its consulting assignments, AMC is paid a fee according to its normal per diem rates and is reimbursed for out-of-pocket expenses related to the assignments.

Neither AMC nor the contributors to this letter and the ITSR attached to this letter have any interest, direct or indirect, in Newcrest or Newmont, or their subsidiaries or associated companies that could be reasonably construed to affect their independence. AMC will not receive benefits other than the fee paid to AMC in connection with preparation of the ITSR. That fee paid to AMC is not dependent on the contents of this letter and the ITSR attached to this letter. Therefore, AMC does not have any pecuniary or other interests that could reasonably be regarded as capable of affecting its ability to provide an unbiased opinion as presented in this letter and the ITSR attached to this letter.

AMC does not, nor do its directors or employees, have any other business relationship with Newcrest or related companies other than the carrying out of individual consulting assignments as engaged. AMC has had no part in formulation of the Newmont Transaction or its outcome.

Based on the above, AMC concludes that it is independent.

AMC's sources of information and site visits

Principal items of information provided by Newcrest via a dataroom to AMC and considered by AMC in the preparation of this letter and the ITSR attached to this letter are listed in Appendix B of the ITSR. That list is not exhaustive.

Additionally, AMC visited the Mineral Assets' key operations for the purposes of preparing this letter and the ITSR attached to this letter:

- | | |
|-------------------|-----------------|
| • Cadia | 6 June 2023 |
| • Telfer-Havieron | 12/13 June 2023 |
| • Lihir | 14/15 June 2023 |
| • Red Chris | 15/16 June 2023 |
| • Brucejack | 17 June 2023 |

Annexure 1. Independent Expert's Report

Newcrest - Independent Technical Specialist's Report

Grant Samuel & Associates Pty Ltd

0223041

Although the Wafi-Golpu and Namosi projects are significant components of the Mineral Assets in terms of value, AMC considered that a site visit was not warranted for the purposes of preparing the ITSR because:

- There were no developments or no activities on site at the time of preparing the ITSR that would, in AMC's opinion, be likely to reveal information that could impact the AMC production cases or AMC's assessments of the risks or opportunities for the project.
- There was sufficient current information available to allow an informed evaluation to be made without an inspection in the form of feasibility studies, photos of drill core, exploration reports, maps, and aerial photos and discussions off-site with Newcrest's management and technical who have been on the working project.

AMC did not visit the exploration projects that are not part of the key operations, or the Ecuadorian, North American, Queensland, or Paterson exploration projects on the basis that they were not material to the overall value of Newcrest.

For the purposes of preparing this letter and the ITSR attached to this letter, in addition to visiting the key operations, AMC reviewed material technical reports and information and held discussions with management and technical staff of Newcrest. The material reviewed included public documents and internal Newcrest information not available to the public. Key documents included the NI 43-101 Technical Reports on certain operations, life-of-mine plans, Mineral Resource and Ore Reserve documentation, feasibility, pre-feasibility, and scoping study reports, management and production reports, specialist reports prepared by external consultants, and technical data including drillhole data, block models, pit and underground design files, topographical surfaces, and mine schedules.

AMC did not audit the information provided to it but aimed to satisfy itself that all that information was prepared in accordance with proper industry standards and is based on data that AMC considers to be of acceptable quality and reliability. Where AMC has not been so satisfied, AMC has included comment in the ITSR and made appropriate modifications in the AMC production cases provided to Grant Samuel and described in the ITSR.

In correspondence relating to AMC's commission by Newcrest to prepare the ITSR, Newcrest agreed to comply with those obligations of the commissioning entity under the VALMIN Code including that it would provide AMC with all the information it is aware of about the subject of AMC's assignment in sufficient detail to enable AMC to determine its relevance.

Newcrest has represented in writing that to the best of its knowledge, it has provided AMC with all material information relevant to its Mineral Assets as described in the ITSR.

In preparing this letter and the ITSR attached to this letter, AMC has relied on information provided by Newcrest, and AMC has no reason to believe that information is materially misleading or incomplete or contains any material errors.

Newcrest, through its acceptance of AMC's proposal to prepare the ITSR, agreed to release and indemnify AMC for any loss or damage howsoever arising from AMC's reliance on any information provided by Newcrest in connection with this letter and the ITSR attached to this letter that is materially inaccurate or incomplete.

Newcrest was provided with a draft of this letter and the ITSR attached to this letter to enable correction of any factual errors and notation of any material omissions. The views, statements, opinions, and conclusions expressed by AMC in the ITSR are based on the assumption that all data provided to it by Newcrest are complete, factual, and correct to the best of Newcrest's knowledge.

Newcrest - Independent Technical Specialist's Report

Grant Samuel & Associates Pty Ltd

0223041

Effective date

This letter and the ITSR attached to this letter and the conclusions in them are effective at 30 June 2023. Those conclusions may change in the future with changes in relevant metal prices, further exploration, and other technical developments regarding the Mineral Assets, and the market for mineral assets.

AMC production cases

Newcrest provided AMC with a life-of-mine (LOM) plan (LOMP) which is part of a financial model that includes a schedule of physical production (tonnes, grades, and metallurgical recoveries) and an estimate of capital expenditure and operating cost (referred to in this letter and the ITSR attached to this letter as a Newcrest LOMP) for each of the following key components of the Mineral Assets (Key Mineral Assets):

- 1 Cadia
- 2 Telfer and Havieron
- 3 Lihir
- 4 Red Chris
- 5 Brucejack
- 6 Wafi-Golpu
- 7 Namosi

Newcrest advises that it has high confidence that each Newcrest LOMP represents its most likely LOM plan that will be achieved for each of the Mineral Assets concerned. Each Newcrest LOMP is based on current information. Key considerations are the estimates of Mineral Resources and Ore Reserves and, in some cases, provisions for operational developments, such as metallurgical recovery improvements and unit cost reductions, and continued exploration success.

AMC reviewed each Newcrest LOMP and its supporting information and, based on that information, including the associated estimates of Mineral Resources and Ore Reserves and exploration prospectivity, AMC prepared two LOM schedules of physical production and costs (AMC production cases) for Cadia, Telfer (and Havieron), Lihir, Red Chris, Brucejack, and Wafi-Golpu where AMC considered there is a reasonable basis to do so. AMC then provided those AMC production cases to Grant Samuel for its consideration of value of the Key Mineral Assets.

Namosi has been the subject of several studies since 1994 including at concept and pre-feasibility level, the most recent study, a concept study in 2019 which reviewed the optimum scale for the project, and value-add options to improve the economics of Namosi. There is no estimate of Ore Reserves stated for Namosi.

Although Newcrest provided a Newcrest LOMP for Namosi, AMC, in conjunction with Grant Samuel, considered that there was not a reasonable basis for preparation of AMC production cases for this asset. Therefore, AMC valued this asset as a Mineral Resource using a method commonly accepted in the industry for independent valuations of Mineral Resources. AMC also considered that method for valuing Newcrest's Mineral Resources not reflected in the AMC production cases.

For the Key Mineral Assets for which AMC prepared two production cases, AMC considered that those cases constitute a reasonable range of technical inputs for use by Grant Samuel in its valuation of those Key Mineral Assets. That range does not represent the absolute bounds of possible or likely outcomes because actual production and costs will naturally be dependent on further mineral exploration, technical developments, and economic factors that impact the Key Mineral Assets. Those developments and factors could, in turn, result in LOM schedules and costs that lie outside the range represented by the two AMC production cases.

Newcrest - Independent Technical Specialist's Report

Grant Samuel & Associates Pty Ltd

0223041

However, based on AMC's experience in the industry, combined with its assessment of the technical attributes and prospectivity of the Key Mineral Assets, AMC considers that the range represented by the two AMC production cases provides what a willing and knowledgeable buyer and a willing and knowledgeable seller might reasonably use in valuing the Key Mineral Assets.

Accordingly, the two AMC production cases can be generally described as:

- **AMC Production Case 1.** An AMC Production Case 1 is typically based on estimates of Ore Reserves and that part of Mineral Resources from which AMC had confidence of an extension to the mine life based on Ore Reserves only. Where such extensions are included, they are scheduled as late in the mine life as is practicable.
- **AMC Production Case 2.** An AMC Production Case 2 typically has mining and processing inventories additional to those of the corresponding AMC Production Case 1 or may show a different development and production schedule or cost structure which are included where AMC considered there is a reasonable basis for those additional inventories and, consequently, an extension to the mine life, or an increase in the production rate. Such additional inventories could, in AMC's opinion, reasonably be expected to be sourced, with further mineral exploration and related assessments from existing Mineral Resources or from exploration targets. Where such additions are included, they are scheduled as late in the mine life as is practicable. It should be noted that such additions are of a lesser confidence level, that is, they entail higher risk than that which applies to the basis of AMC Production Case 1. Accordingly, realisation of an AMC Production Case 2 requires continued success in mineral exploration, resource definition drilling, and conversion to Ore Reserves, or an increase in production rate as a result of additional capital expenditure or technical developments. In AMC's experience and opinion, a willing and knowledgeable buyer and a willing and knowledgeable seller would consider the risk associated with realising an AMC Production Case 2 in their valuations of the Key Mineral Assets.

Notwithstanding that an AMC Production Case 2 inherently involves higher risk than an AMC Production Case 1, AMC believes that both AMC production cases are based on reasonable grounds and represent a likely range of outcomes for the various assets. Those grounds for each of the Key Mineral Assets for which AMC production cases were prepared are presented in the relevant sections of the ITSR.

The AMC production cases were provided to Grant Samuel electronically in Excel format.

AMC valuation of exploration assets

AMC has provided Grant Samuel with valuations of Mineral Resources not included in the AMC production cases and the exploration assets of Newcrest (Exploration Assets) that are located remote from the operations and projects under development. AMC has not visited the Exploration Assets.

For the Exploration Assets, it is not possible to project cash flows and/or production estimates with sufficient confidence to rely on discounted cash flow methodology. AMC therefore has considered other methods to value the Exploration Assets. These methods are commonly used in Australia to value exploration assets and are discussed in the ITSR.

The VALMIN Code defines:

- A technical value as an assessment of a mineral asset's future net economic benefit under a set of assumptions deemed most appropriate by a practitioner, excluding any premium or discount to account for market considerations.
- a market value as the estimated amount of money (or the cash equivalent of some other consideration) for which the mineral asset should exchange on the date of valuation between a willing buyer and a willing seller in an arm's length transaction after appropriate marketing wherein the parties each acted knowledgeably, prudently and without compulsion.

Newcrest - Independent Technical Specialist's Report

Grant Samuel & Associates Pty Ltd

0223041

AMC's values of Exploration Assets are Market Values.

AMC's valuations of Newcrest's Mineral Resources that are not reflected in the AMC production cases, and Newcrest's Exploration Assets are summarized in the following table.

Valuation of Mineral Resources not in AMC production cases and Exploration Assets

Mineral Asset		Low (A\$M)	Preferred (A\$M)	High (A\$M)	Low (US\$M)	Preferred (US\$M)	High (US\$M)
Mineral Resources (based on 100%)							
Outside AMC Production Case 1	Cadia*	391	590	859	266	401	584
	Telfer	43	77	111	29	52	75
	Havieron	35	78	122	24	53	83
	O'Callaghans	40	61	82	27	41	56
	Lihir	202	325	448	137	221	305
	Red Chris	71	229	480	48	156	326
	Brucejack	97	182	267	66	124	182
	Namosi	48	167	286	33	114	194
	Wafi-Golpu	-	-	-	-	-	-
Total		927	1,709	2,655	630	1,162	1,805
Outside AMC Production Case 2	Cadia*	540	772	1,084	367	525	737
	Telfer	23	46	70	16	31	48
	Havieron	2	25	47	1	17	32
	O'Callaghans	40	61	82	27	41	56
	Lihir	202	325	448	137	221	305
	Red Chris	26	92	205	18	63	139
	Brucejack	27	77	128	18	52	87
	Namosi	48	167	286	33	114	194
	Wafi-Golpu	-	-	-	-	-	-
Total		908	1,565	2,350	617	1,064	1,598
Exploration Assets (based on 100%)							
Total		65	89	112	44	60	76
Exploration Assets (based on Newcrest equity)							
Total		10	20	30	7	14	21

Note: *DCF value based on AMC schedules.

Tenure

Newcrest provided AMC with recent independent reports on the standing of its material tenements (Tenure Reports). The titles of the Tenure Reports are listed in Appendix B to the ITSR. Further to those Tenure Reports, AMC has prepared the ITSR on the basis that the material tenements are current and in good standing.

Qualifications

AMC is a firm of mineral industry consultants whose activities include the preparation of due diligence reports and reviews on mining and exploration projects for equity and debt funding and for public reports.

The contributors to the ITSR are listed in Appendix A.

Newcrest - Independent Technical Specialist's Report

Grant Samuel & Associates Pty Ltd

0223041

Format of the ITSR

The ITSR attached to this letter is in the form of separate sections for each of the Mineral Assets.

In the ITSR:

- The valuation date is 30 June 2023.
- Monetary figures are expressed in 2023 Australian dollars (A\$) or United States dollars (US\$) or Canadian dollars (CAD\$) unless otherwise noted.
- Costs are presented on a real, cash cost basis unless otherwise specified.
- Production and costs are presented on a financial year (FY), 1 July to 30 June basis unless otherwise specified.
- Abbreviations are defined and a glossary of terms used are presented in the introductory section of the ITSR.
- A list of contributors to the ITSR is presented in Appendix A.
- A list of key reference material is presented in Appendix B.

Fees

Newcrest will pay AMC a professional fee of approximately A\$1,000,000 according to AMC's normal per diem rates for the preparation of the ITSR and reimburse AMC for of out-of-pocket expenses. The fee or its payment is not contingent upon the content of the ITSR or the outcome of the Newmont Transaction, and AMC will not receive any other benefit for the preparation of the ITSR.

Consent

The ITSR has been provided to Grant Samuel for the purposes of forming its opinion as to whether the Newmont Transaction is in the best interests of the Newcrest shareholders. AMC has given its consent for the ITSR to be appended to Grant Samuel's IER and to be included, in full, in the scheme documents and has not withdrawn that consent before their lodgement with the Australian Securities & Investments Commission. Neither this letter or the ITSR nor any part of them may be used for any other purpose without written consent.

The signatories to this letter and, accordingly, the ITSR attached to this letter are corporate members of the AusIMM and bound by its Code of Ethics.

Yours faithfully



David Varcoe
F AusIMM
Principal Mining Engineer



Lawrie Gillett
F AusIMM
Principal Mining Engineer

Newcrest - Independent Technical Specialist's Report

Grant Samuel & Associates Pty Ltd

0223041

Contents

1	Introduction	1
1.1	Sources of information	1
2	Cadia	2
2.1	Location and background	2
2.1.1	Location	2
2.1.2	Background	3
2.1.3	Tenement holdings	3
2.1.4	Production performance	6
2.2	Site visit	6
2.3	Geology and Mineral Resources	6
2.3.1	Geology	6
2.3.2	Cadia Mineral Resources and estimation	8
2.3.3	Cadia East Underground Mineral Resource	9
2.3.3.1	Data collection	9
2.3.3.2	Cadia East Mineral Resource estimation	10
2.3.4	Ridgeway Mineral Resource	11
2.3.4.1	Data collection	11
2.3.4.2	Ridgeway Mineral Resource estimation	12
2.3.5	Cadia Extended Underground Mineral Resource	12
2.3.5.1	Data collection	12
2.3.5.2	Cadia Extended UG Mineral Resource estimation	13
2.3.6	Big Cadia Mineral Resource	13
2.3.7	Data collection	13
2.3.7.1	Big Cadia Mineral Resource estimation	14
2.3.9	Exploration and resource potential	15
2.4	Geotechnical investigations	16
2.5	Mining operations and Ore Reserves	19
2.5.1	Mining Methods – Cadia East Operations	19
2.5.2	Current mining operations	20
2.5.2.1	Caves in production	22
2.5.2.2	Caves under development	22
2.5.3	Future mine expansion	22
2.5.4	Ore Reserves and estimation process	24
2.6	Mineral processing	25
2.6.1	Processing plant description	25
2.6.1.1	Molybdenum Plant	26
2.6.2	Metal recovery	28
2.6.3	Concentrate transport and marketing	28
2.6.4	Tailings storage	28
2.6.5	Future ore processing plans	29
2.7	Site infrastructure and services	29
2.7.1	Power supply	29
2.7.2	Water supply	29
2.7.3	Other infrastructure	30
2.8	Environmental, Social, and Permitting	30
2.8.1	Environmental and regulatory approvals background	30
2.8.2	Current Primary Approvals	30
2.8.3	Future approvals	33
2.8.4	Cultural Heritage	34
2.8.5	Rehabilitation and closure planning	34
2.8.6	Conclusions	35
2.9	Costs	36
2.9.1	Operating costs	36
2.9.2	Capital expenditure	36
2.10	AMC production cases	36

Annexure 1. Independent Expert's Report

Newcrest - Independent Technical Specialist's Report

Grant Samuel & Associates Pty Ltd

0223041

2.10.1	AMC Production Case 1	37
2.10.2	AMC Production Case 2	38
2.11	Key risks and opportunities	38
2.11.1	Risks	38
2.11.2	Opportunities	39
3	Telfer and Havieron	40
3.1	Location and background	40
3.1.1	Location	40
3.1.2	Background	41
3.1.3	Tenement holdings	41
3.1.4	Production performance	42
3.2	Site visit	43
3.3	Telfer geology and Mineral Resources	43
3.3.1	Geology	43
3.3.2	Mineral Resources	45
3.3.3	Data collection	46
3.3.4	Mineral Resource estimation methodology	49
3.3.5	AMC estimation validation	52
3.3.6	AMC comments on the Mineral Resources estimates	52
3.3.7	Exploration and resource potential	53
3.4	Geotechnical investigations	53
3.5	Mining operations and Ore Reserves	54
3.5.1	Current mining operations	54
3.5.2	Future mine expansion	54
3.5.3	Ore Reserves and estimation process	54
3.5.4	Resource development and future mining concepts	56
3.6	Mineral processing	58
3.6.1	Processing plant description	58
3.6.2	Metal recovery and concentrate grade	59
3.6.3	Concentrate transport and marketing	59
3.6.4	Tailings storage	59
3.6.5	Future ore processing plans	60
3.7	Site infrastructure and services	60
3.7.1	Power supply	60
3.7.2	Water supply	60
3.7.3	Other infrastructure	60
3.8	Environmental, Social, and Permitting	61
3.8.1	Environmental and regulatory approvals background	61
3.8.2	Environmental and social assessments, control, and management	62
3.8.3	Future approvals	62
3.8.4	SEB offsets	62
3.8.5	Greenhouse gas emissions and renewable energy targets	63
3.8.6	Cultural Heritage	63
3.8.7	Rehabilitation and closure planning	64
3.8.8	Conclusions	64
3.9	Costs	65
3.9.1	Operating costs	65
3.9.2	Capital expenditure	65
3.10	AMC production cases	66
3.10.1	AMC Production Case 1	66
3.10.2	AMC Production Case 2	68
3.11	Key risks and opportunities	69
3.11.1	Risks	69
3.11.2	Opportunities	69
4	Lihir	70
4.1	Location and background	70

Newcrest - Independent Technical Specialist's Report

Grant Samuel & Associates Pty Ltd

0223041

4.1.1	Location.....	70
4.1.2	Background.....	70
4.1.3	Tenement holdings.....	72
4.1.4	Operational history.....	73
4.2	Site Visit.....	74
4.3	Geology and Mineral Resource.....	74
4.3.1	Geology.....	74
4.3.2	Lihir Mineral Resources and estimation.....	76
4.3.3	Data collection.....	76
4.3.4	Bulk density.....	78
4.3.5	Data management processing and checks.....	78
4.3.6	Data quality assurance and quality control (QA/QC).....	78
4.3.6.1	Pre 2011.....	78
4.3.6.2	2012 to 2019.....	78
4.3.7	Mineral Resource estimation process.....	78
4.3.8	Grade validation.....	79
4.3.9	Classification criteria.....	79
4.3.10	Estimation summary.....	79
4.3.11	AMC estimation validation.....	79
4.3.12	Conclusions.....	79
4.3.13	Exploration and resource potential.....	80
4.4	Geotechnical investigations.....	80
4.4.1	Lihir Geotechnical Management System.....	80
4.4.2	Geotechnical Design Process.....	80
4.4.3	Lihir Phase 14A Feasibility Study.....	80
4.4.4	Near Shore Barrier.....	81
4.4.5	Kapit extension – preliminary scoping study.....	81
4.4.6	Geotechnical Implementation and Operations.....	82
4.4.7	Closing Commentary.....	82
4.5	Mining operations and Ore Reserves.....	83
4.5.1	Current mining operations.....	85
4.5.2	Future mine expansion.....	86
4.5.3	Ore Reserves and estimation process.....	86
4.5.4	Resource development and future mining concepts.....	87
4.6	Mineral processing.....	87
4.6.1	Processing plant description.....	87
4.6.2	Metal recovery.....	89
4.6.3	Product transport and marketing.....	90
4.6.4	Tailings storage.....	90
4.6.5	Future ore processing plans.....	90
4.7	Site infrastructure and services.....	90
4.7.1	Power supply.....	90
4.7.2	Water supply.....	90
4.8	Environmental, Social, and Permitting.....	90
4.8.1	Environmental and regulatory approvals background.....	90
4.8.2	Future approvals.....	94
4.8.3	Rehabilitation and closure planning.....	94
4.8.4	Conclusions.....	95
4.9	Operating Costs.....	96
4.10	AMC production cases.....	96
4.10.1	AMC Production Case 1.....	96
4.10.2	AMC Production Case 2.....	98
4.11	Key risks and opportunities.....	99
4.11.1	Risks.....	99
4.11.2	Opportunities.....	100
5	Red Chris.....	101

Annexure 1. Independent Expert's Report

Newcrest - Independent Technical Specialist's Report

Grant Samuel & Associates Pty Ltd

0223041

5.1	Location and background	101
5.1.1	Location.....	101
5.1.2	Background	101
5.1.3	Tenement holdings.....	102
5.1.4	Operational history.....	103
5.2	Site Visit.....	103
5.3	Geology and Mineral Resources	103
5.3.1	Geology	103
5.3.2	Mineral Resources and estimation	104
5.3.3	Data collection.....	105
5.3.4	Bulk density	105
5.3.5	Data management	106
5.3.6	Data management processing and checks	106
5.3.7	Data quality assurance and quality control (QA/QC)	106
5.3.8	Mineral Resource estimation process	107
5.3.9	Grade validation	108
5.3.10	Classification criteria	108
5.3.11	Estimation summary	109
5.3.12	AMC estimation validation	109
5.3.13	Conclusions.....	109
5.3.14	Exploration and resource potential	109
5.4	Geotechnical investigations	110
5.4.1	Data collection.....	111
5.4.2	Geotechnical characterization	111
5.4.3	Cave propagation and subsidence modelling.....	112
5.4.4	Ground support	113
5.4.5	Cave monitoring	113
5.4.6	Geotechnical risk and management.....	113
5.5	Mining operations and Ore Reserves.....	113
5.5.1	Current mining operations.....	113
5.5.1.1	Open pit.....	113
5.5.1.2	Underground	116
5.5.2	Future mine expansion	117
5.5.2.1	Open Pit.....	117
5.5.2.2	Underground	117
5.5.3	Ore Reserves and estimation process	118
5.5.3.1	Open pit.....	119
5.5.3.2	Underground	119
5.5.4	Resource development and future mining concepts	120
5.5.4.1	Underground	120
5.6	Mineral processing	120
5.6.1	Processing plant description	120
5.6.2	Metal recovery and concentrate grade	121
5.6.3	Concentrate transport and marketing	122
5.6.4	Tailings storage	122
5.6.5	Future ore processing plans.....	122
5.7	Site infrastructure and services	122
5.7.1	Power supply	122
5.7.2	Water supply	122
5.7.3	Other infrastructure	123
5.8	Environmental, Social, and Permitting	123
5.8.1	Environmental and regulatory approvals background	123
5.8.2	Environmental and social assessments, control, and management	123
5.8.3	Future approvals.....	123
5.8.4	Greenhouse gas emissions and renewable energy targets	124
5.8.5	Cultural Heritage.....	124
5.8.6	Rehabilitation and closure planning	125



Newcrest - Independent Technical Specialist's Report

Grant Samuel & Associates Pty Ltd

0223041

5.9	Costs	126
5.9.1	Operating costs	126
5.9.2	Capital expenditure	127
5.10	AMC production cases	127
5.10.1	AMC Production Case 1	128
5.10.2	AMC Production Case 2	128
5.11	Key risks and opportunities	129
5.11.1	Risks	129
5.11.2	Opportunities	130
6	Brucejack	131
6.1	Location and background	131
6.1.1	Location	131
6.1.2	Background	131
6.1.3	Tenement holdings	132
6.1.4	Operational history	133
6.2	Site Visit	133
6.3	Geology and Mineral Resources	133
6.3.1	Geology	133
6.3.2	Mineral Resources and estimation	135
6.3.3	Data collection	135
6.3.4	Bulk density	136
6.3.5	Data management	136
6.3.6	Data management processing and checks	136
6.3.7	Data quality assurance and quality control (QA/QC)	137
6.3.8	Mineral Resource estimation process	137
6.3.9	Grade validation	137
6.3.10	Classification criteria	138
6.3.11	Mineral Resource estimate reporting	138
6.3.12	Estimation summary	138
6.3.13	Conclusions	138
6.3.14	Exploration and resource potential	138
6.4	Geotechnical investigations	139
6.4.1	Data collection	139
6.4.2	Geotechnical characterization	139
6.4.3	Stope dimensions and dilution estimates	140
6.4.4	Ground support	141
6.4.5	Geotechnical risk and management	141
6.5	Mining operations and Ore Reserves	141
6.5.1	Current mining operations	141
6.5.2	Future mine expansion	142
6.5.3	Ore Reserves and estimation process	143
6.5.4	Resource development and future mining concepts	144
6.6	Mineral processing	144
6.6.1	Processing plant description	145
6.6.2	Metal recovery and concentrate grade	145
6.6.3	Concentrate transport and marketing	146
6.6.4	Tailings storage	146
6.6.5	Future ore processing plans	146
6.7	Site infrastructure and services	146
6.7.1	Power supply	146
6.7.2	Water supply	146
6.7.3	Other infrastructure	146
6.8	Environmental, social, and permitting	147
6.8.1	Environmental and regulatory approvals background	147
6.8.2	Environmental and social assessments, control, and management	148
6.8.3	Future approvals	148

Annexure 1. Independent Expert's Report

Newcrest - Independent Technical Specialist's Report

Grant Samuel & Associates Pty Ltd

0223041

6.8.4	SEB offsets	149
6.8.5	Greenhouse gas emissions and renewable energy targets	149
6.8.6	Cultural Heritage.....	149
6.8.7	Stakeholder engagement	150
6.8.8	Rehabilitation and closure planning	150
6.9	Costs	151
6.9.1	Operating costs	151
6.9.2	Capital expenditure	151
6.10	AMC production cases	151
6.10.1	AMC Production Case 1	151
6.10.2	AMC Production Case 2	152
6.11	Key risks and opportunities	153
6.11.1	Risks	153
6.11.2	Opportunities	153
7	Wafi-Golpu	155
7.1	Location and background	155
7.1.1	Location.....	155
7.1.2	Background.....	155
7.1.3	Tenement holdings.....	156
7.1.4	Project status	156
7.2	Site Visit.....	156
7.3	Geology and Mineral Resources	156
7.3.1	Golpu deposit	156
7.3.1.1	Geology	157
7.3.1.2	Data collection.....	159
7.3.1.3	Mineral Resource estimation	162
7.3.2	Wafi deposit	167
7.3.2.1	Geology	168
7.3.2.2	Data collection.....	169
7.3.2.3	Mineral Resource estimation	171
7.3.3	Nambonga deposit	173
7.3.3.1	Geology	173
7.3.3.2	Data collection.....	175
7.3.3.3	Mineral Resource estimate.....	176
7.4	Mining operations and Ore Reserves.....	179
7.4.1	Current mining operations.....	179
7.4.2	Ore Reserves and estimation process	179
7.4.3	Resource development and future mining concepts	181
7.5	Mineral processing	181
7.5.1	Processing plant description	181
7.5.2	Metal recovery and concentrate grade	182
7.5.3	Concentrate transport and marketing	184
7.6	Environmental, Social, and Permitting	184
7.6.1	Environmental and regulatory approvals background	184
7.6.2	Closure Cost Estimates	189
7.6.3	Conclusions.....	189
7.7	Costs	189
7.7.1	Operating costs	189
7.7.2	Capital expenditure	189
7.8	AMC Production Case1.....	190
7.9	Key risks and opportunities	191
7.9.1	Risks	191
7.9.2	Opportunities	191
8	Namosi.....	192
8.1	Location and background	192
8.1.1	Tenement holdings.....	192

Newcrest - Independent Technical Specialist's Report

Grant Samuel & Associates Pty Ltd

0223041

8.2	Site visit	193
8.3	Geology and Mineral Resources	193
8.3.1	Wainaulo deposit	193
8.3.1.1	Geology	193
8.3.1.2	Data collection	194
8.3.1.3	Mineral Resource estimation	196
8.3.2	Waisoi deposit	199
8.3.2.1	Geology	199
8.3.2.2	Data collection	199
8.3.2.3	Mineral Resource estimation	201
8.4	Mining Operations and Ore Reserves	204
8.5	Mineral Processing	204
8.6	Environment, Social, and Permitting	204
8.7	Costs	204
8.8	AMC production cases	204
8.9	Key risks and opportunities	204
8.9.1	Risks	204
8.9.2	Opportunities	204
9	Valuation of Exploration Assets	205
9.1	Valuation methods – Mineral Resources and Exploration Assets	205
9.1.0	The Yardstick Value method	205
9.1.1	The Unit Area method	205
9.1.2	The Joint Venture Terms method	205
9.1.3	The Past Expenditure Method	205
9.2	Mineral Resources not included in AMC production cases	206
9.2.1	Cadia	212
9.2.2	Telfer-Havieron	213
9.2.3	Lihir	214
9.2.4	Red Chris	214
9.2.5	Brucejack	215
9.2.6	Namosi	216
9.2.7	Wafi-Golpu	216
9.3	Exploration Assets without Mineral Resources	217
9.4	Summary valuation – Mineral Resources outside the AMC production cases and Exploration Assets	231

Tables

Table 2.1	Material Cadia tenements	3
Table 2.2	Cadia recent production performance	6
Table 2.3	Cadia Mineral Resources as at 30 June 2023	9
Table 2.4	Damage level forecast for critical underground infrastructure	17
Table 2.5	Cadia Ore Reserve estimate as at 30 June 2023	24
Table 2.6	Primary Approvals	31
Table 2.7	NSW EPA Penalty Notices in the last 10 years	33
Table 2.8	Cadia historical unit operating costs	36
Table 2.9	AMC Production Case 1 – Cadia production schedule	37
Table 2.10	AMC Production Case 1 – Cadia cost schedule	37
Table 2.11	AMC Production Case 2 – Cadia production schedule	38
Table 2.12	AMC Production Case 2 – Cadia cost schedule	38
Table 3.1	Telfer and Havieron -material land tenure and authorisations	41
Table 3.2	Telfer recent production performance	42
Table 3.3	Telfer Gold and Copper Mineral Resources as at 30 June 2023	46

Annexure 1. Independent Expert's Report

Newcrest - Independent Technical Specialist's Report

Grant Samuel & Associates Pty Ltd

0223041

Table 3.4	O'Callaghans Polymetallic Mineral Resources as at 30 June 2023	46
Table 3.5	Telfer and Havieron Ore Reserves as at 30 June 2023	55
Table 3.6	Telfer historical operating costs	65
Table 3.7	Telfer historical unit operating costs	65
Table 3.8	Telfer-Havieron estimate of capital expenditure	66
Table 3.9	AMC Production Case 1 – Telfer-Havieron production schedule	67
Table 3.10	AMC Production Case 1 – Telfer-Havieron cost schedule.....	68
Table 3.11	AMC Production Case 2 – Telfer-Havieron production schedule	68
Table 3.12	AMC Production Case 2 – Telfer-Havieron cost schedule.....	69
Table 4.1	Lihir – material tenements	73
Table 4.2	Lihir historical mining and processing data	73
Table 4.3	Latest alteration sub-domains.	76
Table 4.4	Lihir Mineral Resources as at 30 June 2023	76
Table 4.5	Lihir NSB capital expenditure	86
Table 4.6	Lihir Ore Reserves as at 30 June 2023.....	86
Table 4.7	Lihir historical gold production.....	90
Table 4.8	Primary Approvals.....	91
Table 4.9	Lihir historical operating costs	96
Table 4.10	Lihir historical unit operating costs	96
Table 4.11	AMC Production Case 1 – Lihir production schedule	97
Table 4.12	AMC Production Case 1 – Lihir cost schedule	98
Table 4.13	AMC Production Case 2 – Lihir production schedule	98
Table 4.14	AMC Production Case 2 - Lihir cost schedule.....	98
Table 5.1	Red Chris key land tenure and authorisations	102
Table 5.2	Red Chris historical mining and processing data (reported on 100% basis)	103
Table 5.3	Red Chris Mineral Resources as at 30 June 2023.....	105
Table 5.4	Scheduled inventory by material type.....	116
Table 5.5	Red Chris Ore Reserve estimate as at 30 June 2023.....	119
Table 5.6	Material types by NSR value.....	119
Table 5.7	Red Chris historical operating costs (reported on 100% basis).....	127
Table 5.8	Red Chris historical unit operating costs (reported on 100% basis)	127
Table 5.9	AMC Production Case 1 – Red Chris production schedule.....	128
Table 5.10	AMC Production Case 1 – Red Chris cost schedule.....	128
Table 5.11	AMC Production Case 2 – Red Chris production schedule.....	129
Table 5.12	AMC Production Case 2 – Red Chris cost schedule.....	129
Table 6.1	Brucejack – key land tenure and authorisations	132
Table 6.2	Brucejack historical mining and processing data	133
Table 6.3	Brucejack Mineral Resources as at 30 June 2023	135
Table 6.4	Stope dimension and dilution guidelines	140
Table 6.5	Brucejack Ore Reserves as at 30 June 2023	143
Table 6.6	Brucejack historical operating costs.....	151
Table 6.7	Brucejack historical unit operating costs	151
Table 6.8	AMC Production Case 1 – Brucejack production schedule	152
Table 6.9	AMC Production Case 1 – Brucejack cost schedule	152
Table 6.10	AMC Production Case 2 – Brucejack production schedule	153
Table 6.11	AMC Production Case 2 – Brucejack cost schedule	153



Newcrest - Independent Technical Specialist's Report

Grant Samuel & Associates Pty Ltd

0223041

Table 7.1	Wafi-Golpu tenements	156
Table 7.2	Summary of Golpu drilling within the reported resource volume	160
Table 7.3	Volume model parameters.	164
Table 7.4	Wafi Mineral Resource as at 30 June 2023.	168
Table 7.5	Volume model parameters.	171
Table 7.6	Nambonga Mineral Resources as at 30 June 2023.	173
Table 7.7	Volume model parameters.	177
Table 7.8	Golpu Ore Reserves as at 30 June 2023.....	180
Table 7.9	Wafi-Golpu – LOM concentrate production.....	182
Table 7.10	Wafi-Golpu – forecast LOM concentrate grades and tonnes	183
Table 7.11	Minimum assumed Golpu concentrate specifications	183
Table 7.12	Wafi-Golpu - copper concentrate – testwork analysis - major elements	184
Table 7.13	Primary Approval Applications	184
Table 7.14	Golpu forecast operating expenditure FY24 to end of LOM.....	189
Table 7.15	Golpu forecast capital expenditure FY24 to end of LOM.....	190
Table 7.16	AMC Production Case 1 – Golpu production schedule	190
Table 7.17	AMC Production Case 1 – Golpu cost schedule	191
Table 8.1	Namosi tenements	193
Table 8.2	Namosi Mineral Resources as at 30 June 2023.....	193
Table 8.3	Volume model parameters.	197
Table 8.4	Volume model parameters	202
Table 9.1	Gold transactions for tenements with Mineral Resources in Australia and PNG	207
Table 9.2	Gold transactions for tenements with Mineral Resources in Canada	208
Table 9.3	Large gold transactions for tenements with Mineral Resources in other countries	209
Table 9.4	Valuation of Mineral Resources outside Cadia AMC Production Case 1	213
Table 9.5	Valuation of Mineral Resources outside Cadia AMC Production Case 2	213
Table 9.6	Valuation of Mineral Resources outside Telfer-Havieron AMC production cases	214
Table 9.7	Valuation of Mineral Resources outside Lihir AMC production cases	214
Table 9.8	Valuation of Mineral Resources outside Red Chris AMC production cases	215
Table 9.9	Valuation of Mineral Resources outside Brucejack AMC production cases.....	216
Table 9.10	Valuation of Mineral Resources outside Namosi AMC production cases	216
Table 9.11	Valuation of Mineral Resources outside Wafi-Golpu AMC production cases.....	217
Table 9.12	Transactions for tenements in Australia and PNG without Mineral Resources ..	218
Table 9.13	Transactions for tenements in Canada in 2023 without Mineral Resources.....	220
Table 9.14	Summary of valuation of Exploration Assets (based on 100%)	231
Table 9.15	Summary valuation of Mineral Resources outside AMC production cases and Exploration Assets	232

Figures

Figure 2.1	Cadia location	2
Figure 2.2	Cadia MLs - location	4
Figure 2.3	Cadia site layout.....	5
Figure 2.4	Cadia geological plan.....	7
Figure 2.5	Cadia geological cross section 22500N.....	8
Figure 2.6	Cadia East mineralised zonation	9

Annexure 1. Independent Expert's Report

Newcrest - Independent Technical Specialist's Report

Grant Samuel & Associates Pty Ltd

0223041

Figure 2.7	Cadia exploration history	16
Figure 2.8	Predicted damage classes for critical underground excavations at FY48	17
Figure 2.9	Predicted fracture limit and mobilised zone at the end of the LOM	18
Figure 2.10	PC1-2 and PC1-3 geotechnical monitoring programme summary and breakdown	19
Figure 2.11	Cadia - indicative ore production profile	21
Figure 2.12	Cadia - view of active and future stages of caving	21
Figure 2.13	Cadia East panels	24
Figure 2.14	Simplified process flow sheet for Concentrator 1 & 2	26
Figure 2.15	Molybdenum Plant flow sheet	27
Figure 3.1	Telfer location	40
Figure 3.2	Telfer regional geological plan	43
Figure 3.3	Telfer Open Pit resource model below existing pit surface (oblique view looking west)	51
Figure 3.4	Telfer Underground resource models (oblique view looking east)	51
Figure 3.5	Havieron resource model (oblique view looking east)	52
Figure 3.6	Havieron Ore Reserve mine design – longsection looking north	56
Figure 3.7	Telfer Underground – potential future ore sources	57
Figure 3.8	Processing plant flow sheet for Telfer	59
Figure 4.1	Lihir location	70
Figure 4.2	Lihir Island map	72
Figure 4.3	Lihir geology and topography	75
Figure 4.4	Mineral Resource drilling locations by owner	77
Figure 4.5	Lihir pit layout	84
Figure 4.6	Lihir pit phases plan view	84
Figure 4.7	Lihir processing plant flowsheet – grinding and flotation	88
Figure 4.8	Lihir processing plant flowsheet – POX and NCA	88
Figure 4.9	Lihir recent gold recovery performance	89
Figure 5.1	Red Chris location	101
Figure 5.2	Geology map of Red Chris	104
Figure 5.3	Red Chris lithological model - East Zone (Section 27N)	107
Figure 5.4	Red Chris Near-Mine Targets	110
Figure 5.5	Mineralization Long Section View	110
Figure 5.6	Plan view of the Main Zone and East Zone pits	114
Figure 5.7	Plan view of the WRD and the low-grade and mineralized waste stockpile.	115
Figure 5.8	Red Chris block cave production sequence	116
Figure 5.9	Plan View Red Chris Underground	117
Figure 5.10	Conceptual integration of East Ridge Exploration Target.	118
Figure 5.11	Red Chris – processing plant flow diagram	121
Figure 6.1	Brucejack location	131
Figure 6.2	Simplified geology of Brucejack - main mineralised zones	134
Figure 6.3	VOK to West Zone geological section	134
Figure 6.4	Plan view the Brucejack site in relation to underground workings	142
Figure 6.5	Spatial location of the Brucejack Ore Reserves	144
Figure 6.6	Brucejack plant - debottlenecked flowsheet (2022)	145
Figure 6.7	Brucejack infrastructure – regional layout	147



Newcrest - Independent Technical Specialist's Report

Grant Samuel & Associates Pty Ltd

0223041

Figure 7.1	Wafi Golpu location	155
Figure 7.2	Golpu Mineral Resources as at 30 June 2023	157
Figure 7.3	Wafi-Golpu geology.....	157
Figure 7.4	Porphyries in the Golpu intrusive complex.....	158
Figure 7.5	Golpu copper sulphide zonation	159
Figure 7.6	Golpu - drillhole traces	160
Figure 7.7	Copper estimation domains.....	163
Figure 7.8	Gold estimation domains	164
Figure 7.9	Mineral Resource classification.....	166
Figure 7.10	Plan of Wafi drillhole traces.....	170
Figure 7.11	Location of Golpu, Wafi, and Nambonga deposits.....	174
Figure 7.12	Nambonga drillhole traces.....	175
Figure 7.13	Nambonga estimation domains.....	177
Figure 7.14	Golpu Ore Reserve design – view looking north	180
Figure 7.15	Golpu proposed processing flowsheet	182
Figure 7.16	Wafi-Golpu – forecast annual ore milled	183
Figure 8.1	Namosi project location.....	192
Figure 8.2	Wainaulo drillhole traces.....	195
Figure 8.3	Wainaulo copper domains.....	197
Figure 8.4	Waisoi drillhole locations.....	200
Figure 8.5	Waisoi estimation domain	202
Figure 9.1	Yardstick value and deposit size for gold transactions in Australia and Canada and in other countries for deposits with large resource ounces.....	209
Figure 9.2	Ranges of values assigned for Measured, Indicated, and Inferred gold resources based on Australian and Canadian transactions	210
Figure 9.3	Yardstick value and deposit size for copper transactions Australia	211
Figure 9.4	Ranges of values assigned for Measured, Indicated, and Inferred copper resources based on comparable transactions.....	211
Figure 9.5	Comparison of unit area value and tenement area – Australia and PNG	219
Figure 9.6	Comparison of unit urea value and tenement area – Canada	220
Figure 9.7	Cadia and Junction Reefs tenements	222
Figure 9.8	Lihir tenement.....	223
Figure 9.9	Telfer and Paterson region tenements	224
Figure 9.10	Red Chris mineral claim tenement area	226
Figure 9.11	Brucejack mineral claim tenement area	227
Figure 9.12	Wafi-Golpu tenements.....	228
Figure 9.13	Namosi tenement	229

Appendices

Appendix A Contributors to the ITSR

Appendix B References

Annexure 1. Independent Expert's Report

Newcrest - Independent Technical Specialist's Report

Grant Samuel & Associates Pty Ltd

0223041

Distribution list

- 1 e-copy to Grant Samuel & Associates Pty Ltd
- 1 e-copy to AMC Perth office

OFFICE USE ONLY
Version control (date and time)
230907 0900

Newcrest - Independent Technical Specialist's Report

Grant Samuel & Associates Pty Ltd

0223041

1 Introduction

Abbreviations and Glossary of Terms Abbreviations and definitions of technical terms used in this ITSR are as follows.

Unit	Description
/t	per tonne
<	less than
>	greater than
≤	less than or equal to
≥	greater than or equal to
µm	micron
A\$	Australian dollars
A\$M	million Australian dollars
AAS	atomic absorption spectrum assay method
Ag	silver
Alaiya Rock	major significant cultural site with communal cultural inspiration to Lihirians
ALS	ALS Limited
AMC	AMC Consultants Pty Ltd
AMD	acid mine drainage
ASIC	Australian Securities & Investments Commission
ASX	Australian Securities Exchange
Au	gold
AuEq	gold equivalent
BBWi	Bond Ball Mill Work Index
BC	block cave
BCWi	Bond Crusher Work Index
BHP	BHP Group Limited
BRWi	Bond Rod Mill Work Index
BV	Bureau Veritas Laboratories
C°	degree Celsius
CAD\$	Canadian dollars
CCE	closure cost estimate
CEPA	PNG Conservation & Environment Protection Authority
Co	cobalt
CO ₂ ^e	carbon dioxide equivalent
CoG	cut-off grade
Competent Person	person defined in the JORC Code to supervise and sign-off on a Mineral Resource or Ore Reserve estimate
CRMs	certified reference materials
CSW	Coastline Seepage Wall (Lihir)
Cu	copper

Unit	Description
CuEq	copper equivalent
DCCEEW	Commonwealth Department of Climate Change, Energy, the Environment and Water
DCF	discounted cash flow
DD	diamond drilling
DGM	discreet gaussian modelling
DMIRS	WA Department of Mines Industry Regulation and Safety
doré	semi-pure alloy of gold and other metals
DSTP	deep sea tailings placement
EIS	Environmental Impact Statement
ELOS	equivalent linear overbreak/slough method
EMMP	Environmental Management and Monitoring Plan
EMP	environmental management plan
ER1	East Ridge 1 (Red Chris)
ER2	East Ridge 2 (Red Chris)
FA	face angle
FS	feasibility study
FY	financial year (year ending 30 June)
FYXX	financial year ending 30 June 20XX (for example, FY23 is the year ended 30 June 2023)
g	gram
G	giga (billion)
G&A	general and administration
g/t	grams per tonne
GCS	global change of support
GDMS	Geological Data Management System
GPS	Global Positioning System
Grant Samuel	Grant Samuel & Associates Pty Ltd
GWL	groundwater licence
h/a	hours per annum
ha	hectare
HFO	heavy fuel oil
HG	high-grade
HQ	63.5 mm diameter core
IBCA	Impact, Benefit and Co-Management Agreement

Annexure 1. Independent Expert's Report

Newcrest - Independent Technical Specialist's Report

Grant Samuel & Associates Pty Ltd

0223041

Unit	Description
ICP-OES	Inductively Coupled Plasma Optical Emission spectroscopy
ID ²	inverse distance squared estimation method
IER	independent expert's report
IOCG	iron oxide copper gold deposit
ISO	International Organization for Standardization
IT	Information Technology
ITSR	independent technical specialist's report
JORC Code	Australasian Code for Reporting of Exploration Results, Mineral Resources and Ore Reserves, The JORC Code 2012 Edition. Prepared by the Joint Ore Reserves Committee of the Australasian Institute of Mining and Metallurgy, Australasian Institute of Geoscientists and Minerals Council of Australia (JORC). Effective 20 December 2012 and mandatory from 1 December 2013.
JYAC	Jamukurnu Yapalikurnu Aboriginal Corporation
kg	kilogram
kg CO ₂ ^e	kg of carbon dioxide equivalent
km	kilometre
km ²	square kilometre
koz	thousands of ounces
KSB	Kapit Seepage Barrier (Lihir)
kt	kilotonnes
ktpa	kilotonnes per annum
kV	thousand volts
kW	kilowatt
L	litre
L/s	litres per second
LG	Lerchs-Grossmann
LOM	life-of-mine
m	metre
M	mega (million)
m ²	square meter
m ³	cubic meter
masl	metres above sea level
MB1	Macro Block 1
MB2	Macro Block 2
MB3	Macro Block 3
MCF	Mine Call Factor
MCP	Mine Closure Plan

Unit	Description
mg/L	milligram per litre
MHS	Materials Handling System
mi	Hoek-Brown intact rock parameter
MII	Measured, Indicated, and Inferred Mineral Resources
MIK	Multiple Indicator Kriging
Mineral Asset	as defined in the VALMIN Code
Mineral Resource	as defined in the JORC Code
MLpd	million litres per day
mm	millimetre
Mo	Molybdenum
Moz	million ounces
MRA	PNG Mining Resources Authority
mRL	metres reduced level
Mt	million tonnes
Mtpa	million tonnes per annum
MW	megawatt
MWh	megawatt-hour
NAD83 Zone 9	North American Datum of 1983
NAF	non-acid-forming
NAF	non-acid forming
NAG	non-acid generating
NCA	neutralisation, cyanidation, and adsorption
Newcrest	Newcrest Mining Limited
Ni	nickel
NI	National Instrument
NQ	47.6 mm diameter core
NSB	Nearshore soil barrier (Lihir)
NSR	Net Smelter Return
NSW EPA	NSW Environment Protection Authority
NTSF	Cadia Northern TSF
OK	ordinary kriging estimation method
Ore Reserve	as defined in the JORC Code
oz	Troy ounce (31.1035 g)
P ₈₀	product size at which 80% passes
PAF	potentially acid forming
PAG	Potentially Acid Generating
PC	panel cave
PFS	pre-feasibility study
ppm	parts per million
PQ	85 mm diameter core

Newcrest - Independent Technical Specialist's Report

Grant Samuel & Associates Pty Ltd

0223041

Unit	Description
PTSF	Cadia Hill open pit TSF
QA/QC	quality assurance and quality control
QKNA	Quantitative Kriging Neighbourhood Analysis
QP	Qualified Person
RC	reverse circulation
RF	revenue factor
RG 111	ASIC Regulatory Guide 111 – Content of expert reports
RG 112	ASIC Regulatory Guide 112 – Independence of experts
RL	reduced level
ROM	run-of-mine
RPEEE	reasonable prospects for eventual economic extraction as referred to in the JORC Code
RQD	rock quality designation
RSA	Rock Storage Area
S	sulphur
SA	South Australia
SABC	SAG mill & ball mill & single stage pebble crusher
SAG	semi-autogenous grinding
SGS	SGS S.A (Assay laboratory)
SLC	sub-level cave
SLOS	sub-level open stoping
SMU	selective mining unit
STSF	Cadia Southern TSF
t	metric tonne
t _a	JKTech comminution parameter
TIA	tailings impoundment area
tpa	tonnes per annum
tpd	tonnes per day
tph	tonnes per hour
TSF	tailings storage facility
UC	uniform conditioning
UCS	unconfined compressive strength
US\$	United States dollars
US\$/oz	US\$ per troy ounce
US\$M	million United States dollars
VALMIN Code	Australasian Code for Public Reporting of Technical Assessments and Valuations of Mineral Assets, The VALMIN Code, 2015 Edition. Prepared by the VALMIN Committee of the Australasian Institute of Mining and Metallurgy

Unit	Description
	(AusIMM) and Australian Institute of Geoscientists (AIG). Effective 30 January 2016. Mandatory for AusIMM and AIG members from 1 July 2016.
VOK	Valley of the Kings (Brucejack)
WA EPA	WA Environmental Protection Authority
WRD	waste rock dump
WRTSF	waste rock tailings storage facility
WZ	West Zone (Brucejack)
YTD	year-to-date

Annexure 1. Independent Expert's Report

Newcrest - Independent Technical Specialist's Report

Grant Samuel & Associates Pty Ltd

0223041

1.1 Sources of information

Newcrest's Mineral Resources and Ore Reserves are classified and reported according to the JORC Code³. In connection with the Toronto Stock Exchange listing, Newcrest has also reconciled estimates with the Canadian Institute of Mining Metallurgy and Petroleum (CIM) Definition Standards referenced by Canadian Securities Administrators National Instrument 43-101 (NI 43-101).

The information in this ITSR is derived from:

- Publicly available information on the Newcrest website, such as the Newcrest 2022 Annual Report, 2022 Sustainability Report, NI 43-101 Technical Reports for Cadia, Lihir, Red Chris, and Wafi-Golpu, and the 30 June 2023 Resources and Reserves Statement.
- Publicly available information on various government and third-party websites.
- Various Newcrest and independent consultant technical reports provided by Newcrest for each of the Mineral Assets, as listed in Appendix B.

Maps and diagrams included in this ITSR were provided by Newcrest unless stated otherwise.

³ Australasian Code for Reporting of Exploration Results, Mineral Resources and Ore Reserves, The JORC Code 2012 Edition. Prepared by the Joint Ore Reserves Committee of the Australasian Institute of Mining and Metallurgy, Australasian Institute of Geoscientists and Minerals Council of Australia (JORC). Effective 20 December 2012 and mandatory from 1 December 2013.

Newcrest - Independent Technical Specialist's Report

Grant Samuel & Associates Pty Ltd

0223041

2 Cadia

2.1 Location and background

2.1.1 Location

The Cadia Valley Operations (Cadia) gold/copper mining and processing complex is located 25km from Orange in the Central Tablelands of New South Wales and 200 km west of Sydney, Australia. The mine principally produces a copper/gold concentrate and gold doré and, as of June 2022, also a molybdenum concentrate. The copper/gold concentrate is pumped to the concentrate dewatering facility located approximately 25 km to the east of Cadia, adjacent to the town of Blayney (refer Figure 2.1). The concentrate is then railed to Port Kembla for export.

Figure 2.1 Cadia location

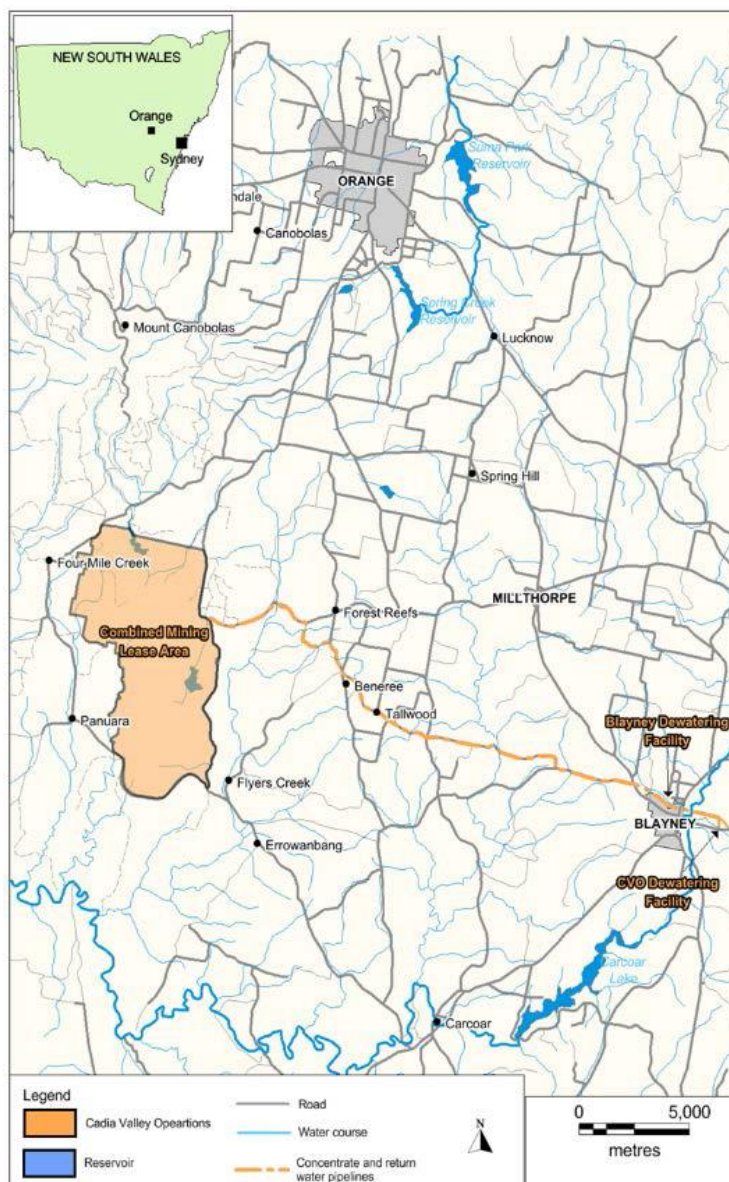

Newcrest - Independent Technical Specialist's Report

Grant Samuel & Associates Pty Ltd

0223041

Land use in the vicinity of the Cadia operations is dominated by sheep and cattle grazing in the more gently undulating areas, and private and state forestry operations to the north and east in the Canobolas State Forest.

2.1.2 Background

Ore is mined underground at Cadia from the Cadia East deposit using the panel cave form of the block cave method. Mine development at Cadia East commenced in 2012 with commercial production following in 2013 and is now a very large-scale underground mining operation adjacent to the Cadia Hill open pit.

Operations at the Cadia Hill open pit ceased by 2014 and, subsequently, the pit has been used for tailings storage. The Ridgeway Deeps and Ridgeway underground mine was also placed into care and maintenance by 2018.

The current operations at Cadia are centred on:

- The Cadia East panel caves.
- Underground crushing at Cadia East and conveyor to surface.
- Ore processing with high pressure grinding roller, semi-autogenous grinding (SAG) mills, ball mills, flotation, and gravity concentration.
- Production of copper/gold concentrate and gold doré.
- Commissioning and operation of the molybdenum plant.

The Newcrest 2022 Annual Report includes reference to the Cadia expansion project consisting of:

- Development of the next block cave, Panel Cave 2-3 (PC2-3).
- Increasing processing plant capacity from 30 Mtpa to 35 Mtpa.
- Improvements in gold and copper recovery and reduction in unit costs.

It was also reported that the Newcrest Board approved the Cadia PC 1-2 Feasibility Study which relates to the next panel cave after PC2-3 and updates and defines a significant portion of Cadia's future mine plan.

2.1.3 Tenement holdings

The Cadia tenure comprises eight mining leases (MLs), seven exploration licences (ELs) and one exploration prospecting licence. Two MLs are currently pending. Currently, granted tenure for the mining is held by Newcrest.

Cadia is located in Cadiangullong Creek Valley within ML1405, ML 1472, ML 1481, ML 1449, ML 1689, and ML 1690 issued under the Mining Act 1992. A summary of the material tenure provided by Newcrest covering Cadia is shown in Table 2.1. The location of the MLs is shown in Figure 2.2. The Cadia site layout is shown in Figure 2.3.

Table 2.1 Material Cadia tenements

Tenement Number	Area (ha)	Tenement Type	Tenement Expiry Date	Status of Currency
ML1405	3,116	Mining Lease	5 October 2038	Current
ML1449	99.16	Mining Lease	5 October 2038	Current
ML1472	1,199.7	Mining Lease	22 October 2021	Renewal pending
ML1481	584.1	Mining Lease	7 March 2043	Current
ML1689	153.57	Mining Lease	11 September 2034	Current
ML1690	70.484	Mining Lease	10 September 2034	Current

Newcrest - Independent Technical Specialist's Report

Grant Samuel & Associates Pty Ltd

0223041

Figure 2.2 Cadia MLs - location



Newcrest - Independent Technical Specialist's Report

Grant Samuel & Associates Pty Ltd

0223041

Figure 2.3 Cadia site layout

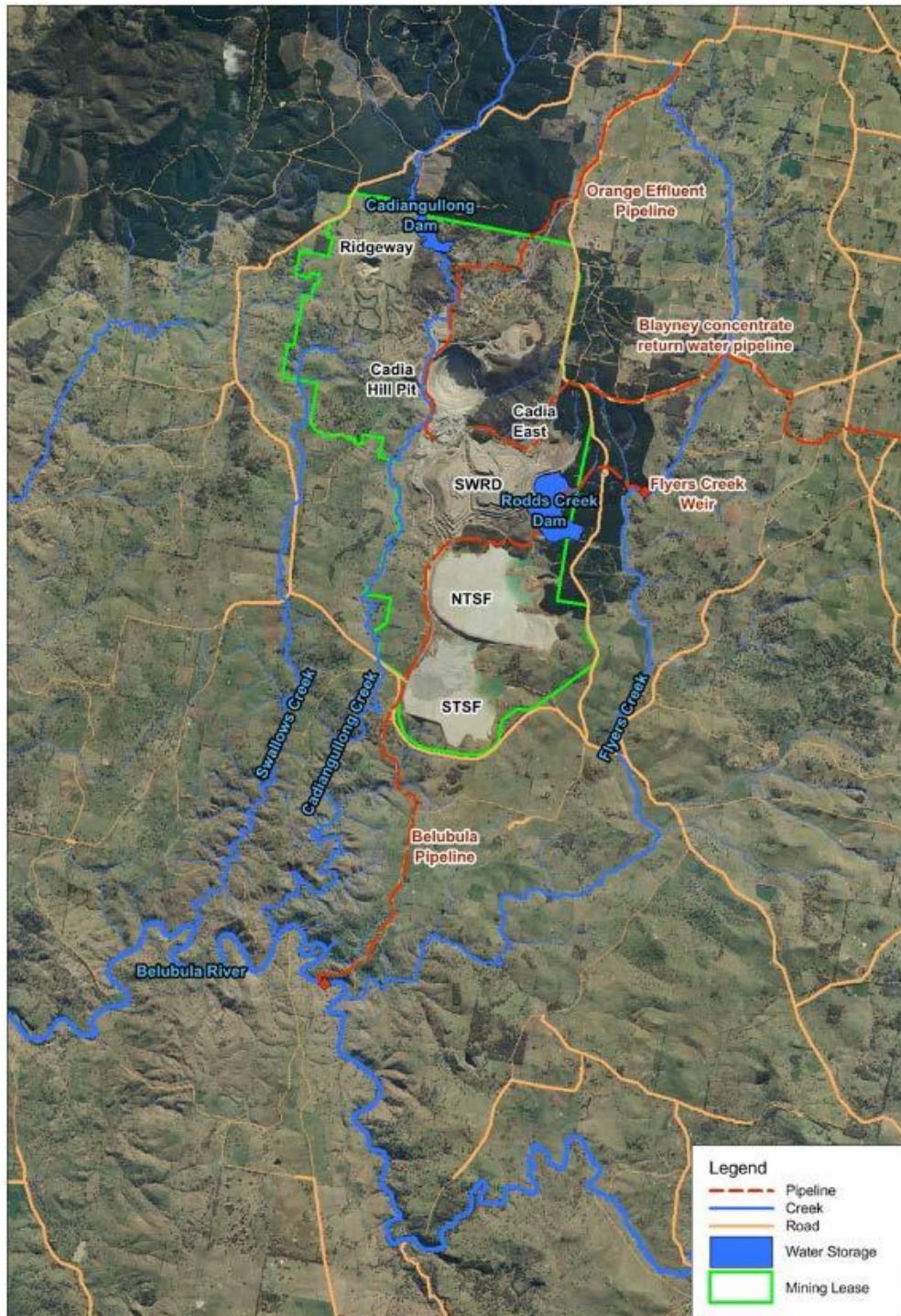

Newcrest - Independent Technical Specialist's Report

Grant Samuel & Associates Pty Ltd

0223041

2.1.4 Production performance

Current mining is at Cadia East via a panel cave form of a block cave operation.

The production performance of Cadia over the past three years is summarised in Table 2.2.

Table 2.2 Cadia recent production performance

Year	Units	FY21	FY22	FY23
Ore mined	Mt	32.51	28.72	29.06
Copper grade mined	%	0.39	0.39	0.38
Gold grade mined	g/t	0.91	0.85	0.70
Ore processed	Mt	32.37	25.86	29.08
Copper feed grade	%	0.40	0.39	0.40
Gold feed grade	g/t	0.95	0.87	0.81
Copper recovery	%	82.6	83.7	84.2
Gold recovery	%	77.4	77.6	79.1
Concentrate produced (dry)	dmt	444,740	357,567	412,198
Copper in concentrate	kt	106	85	98
Gold production (gold in concentrate and doré)	koz	765	561	597

Source: Various Newcrest reports, public documents, and company advice.

It is reported in the Newcrest 2022 Annual Report that in FY22:

- Operating and economic performance in FY22 was impacted by reduced throughput rates during the planned replacement and upgrade of the SAG mill motor which commenced in early July 2021 and was successfully completed in November 2021.
- Approval for Cadia to increase its permitted processing capacity to 35 million tonnes per annum was received.
- The first shipment of molybdenum concentrate was delivered in June 2022 during the commissioning of the new plant.
- The two-stage Cadia plant expansion was nearing completion.
- The Board approved the pre-feasibility study for Cadia's PC1-2. A feasibility study is now well-progressed, and a range of early-works projects have also commenced.
- An Expansion Project which includes the development of the PC2-3 block cave was progressing.

2.2 Site visit

AMC attended the site 5 to 6 June 2023. The visit included inspection of underground workings, the processing plant and tailings dam, and discussion with Newcrest personnel.

2.3 Geology and Mineral Resources

2.3.1 Geology

The Cadia deposits lie within the volcanic rocks of the Late Ordovician Molong Belt in the eastern Lachlan Fold Belt.

Basement rocks comprise Weemalla Formation feldspathic siltstones and sandstones. These are overlain and contemporaneous with the volcanics and volcano-sediments of the Forest Reef Volcanics (FRV) deposited in a sub-marine island arc environment. The Ridgeway deposit straddles the contact between these two formations.

The Cadia Intrusive Complex (CIC) is some 20 million years younger and responsible for emplacement of the porphyry mineralisation into Cadia Valley. These dioritic and monzonitic intrusions outcrop over a large area and are associated with the mineralisation at Ridgeway and

Annexure 1. Independent Expert's Report

Newcrest - Independent Technical Specialist's Report

Grant Samuel & Associates Pty Ltd

0223041

Cadia East. The top of the CIC can be 500 m below surface. The CIC is considered to be associated with a large and complex system of intrusives at depth.

Cadia Hill and Cadia Extended are hosted in an older monzonite. Cadia East is hosted within the FRV sequence.

The Silurian Cadia Coach Shale (CCS) comprising shales, sandstones and limestones overlays the Ordovician rocks. Part of the CCS is the valley fill breccia (VFB) that comprise clasts of the FRV and CIC.

Structurally, the Werribee Fault displaces the Cadia East mineralisation as a regional structure. Splays of this, including the Gibb Fault and Cat fault displace the Cadia Hill block and Cadia East.

Figure 2.4 shows a geological plan of the Cadia area. Figure 2.5 shows a geological cross section of the Cadia area.

Figure 2.4 Cadia geological plan

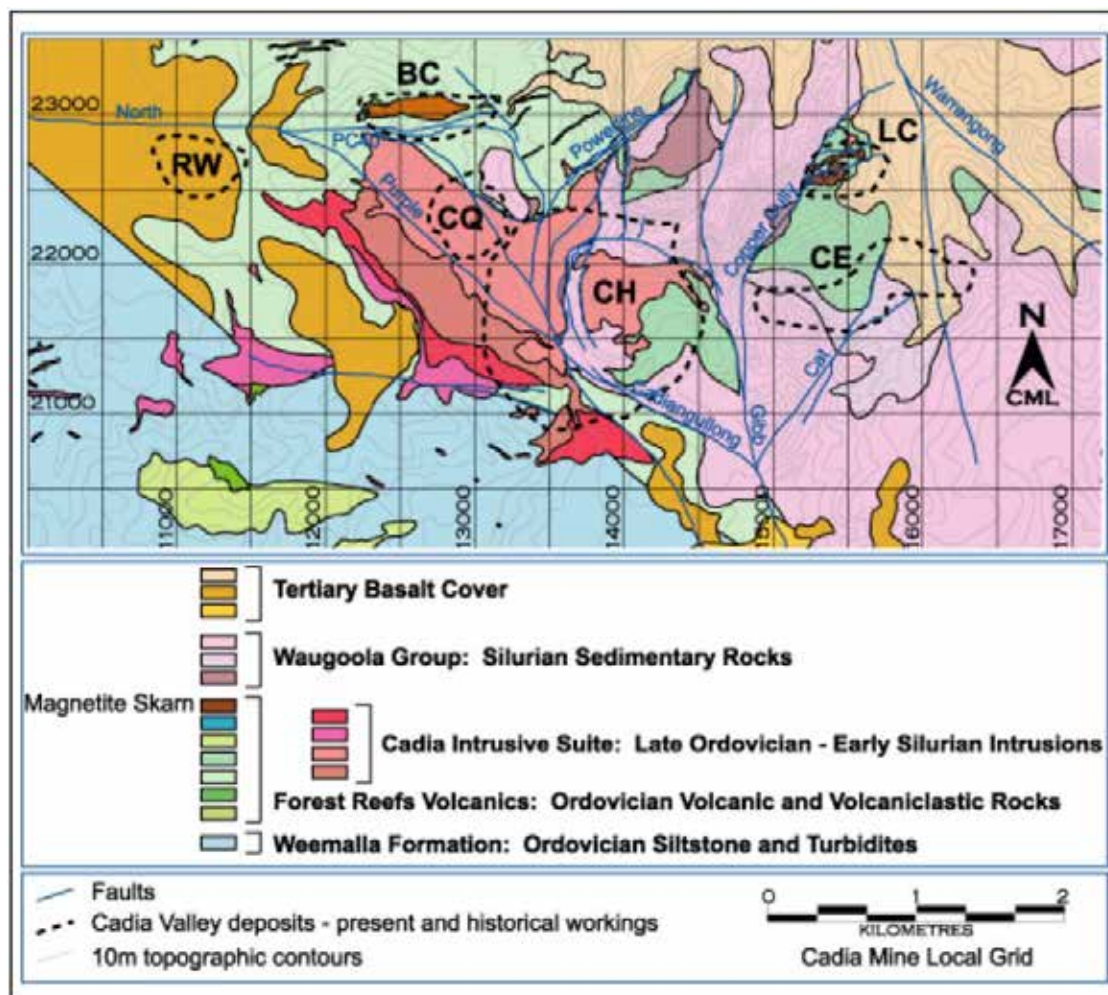

Note: RW=Ridgeway, BC=Big Cadia, CQ=Cadia Quarry, CH=Cadia Hill, CE=Cadia East.

Newcrest - Independent Technical Specialist's Report

Grant Samuel & Associates Pty Ltd

0223041

Figure 2.5 Cadia geological cross section 22500N

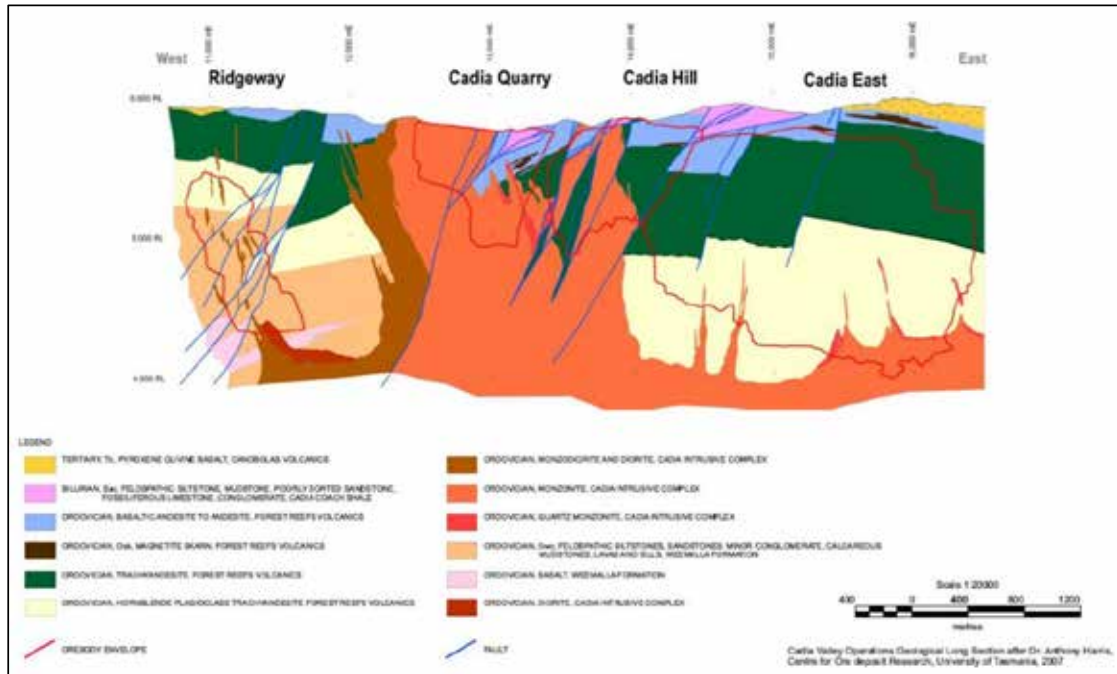

Big Cadia is a tabular body that dips to the southeast with complex folding and faulting. Big Cadia is a skarn deposit with a magnetite hematite alteration resulting from alteration within the FRV in two phases.

Cadia Extension is similar to the larger Cadia Hill deposit. Mineralisation is hosted in a monzonite porphyry adjacent to the contact with the FRV.

Cadia East porphyry has a close spatial association with the Late Ordovician to early Silurian monzodiorite and monzonite dykes hosting mineralisation.

2.3.2 Cadia Mineral Resources and estimation

The Cadia Mineral Resources estimate as at 30 June 2023 are listed in Table 2.3. The Mineral Resources estimate were reported above net smelter return (NSR) cut-offs specified for each deposit. Mineral Resources are also reported for silver and molybdenum.

Newcrest - Independent Technical Specialist's Report

Grant Samuel & Associates Pty Ltd

0223041

Table 2.3 Cadia Mineral Resources as at 30 June 2023

Deposit and Cut-off	Classification	Tonnes Mt (Dry)	Grade				Contained Metal			
			Au (g/t)	Cu (%)	Ag (g/t)	Mo (ppm)	Au (Moz)	Cu (Mt)	Ag (Moz)	Mo (Mt)
Cadia East Underground (NSR A\$18/t)	Indicated	2,600	0.35	0.26	0.65	65	29	6.7	54	0.17
	Inferred	500	0.24	0.17	0.47	25	3.8	0.85	7.5	0.012
Ridgeway Underground (NSR A\$12.50/t)	Indicated	110	0.57	0.30	0.74	-	1.9	0.31	2.5	-
	Inferred	41	0.38	0.40	0.43	-	0.50	0.17	0.56	-
Cadia Extended Underground (NSR A\$18.71/t)	Indicated	80	0.35	0.19	-	-	0.89	0.15	-	-
Cadia Hill Stockpiles (NSR A\$12.81/t)	Measured	32	0.3	0.13	-	-	0.31	0.041	-	-
Big Cadia Open Pit (NSR A\$12.81/t)	Inferred	11	0.70	0.52	-	-	0.25	0.058	-	-

2.3.3 Cadia East Underground Mineral Resource

The Cadia East mineralisation is defined by a disseminated copper rich chalcopyrite zone above a quartz vein-hosted gold rich zone as shown in Figure 2.6. The mineralisation is a stockwork with sheeted quartz sulphide veins within a broadly stratabound zone associated with the monzodiorites.

Figure 2.6 Cadia East mineralised zonation

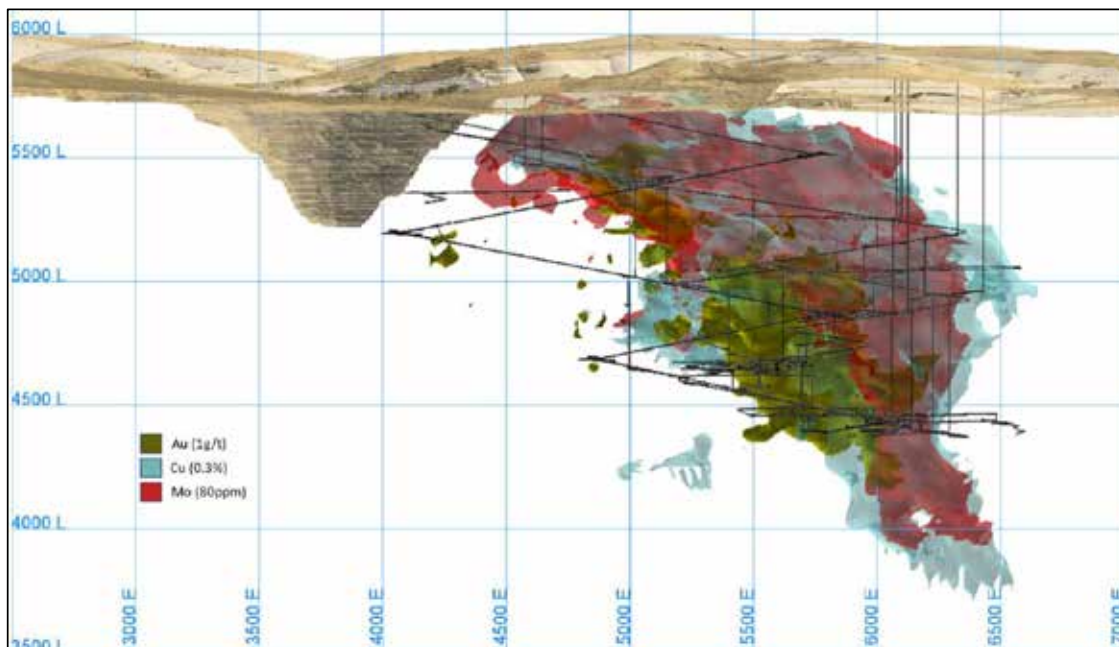

2.3.3.1 Data collection

Drilling at Cadia East consists of 1,761 diamond drillholes (DD) of which 789 are used for the Mineral Resource estimation. There are over 28,136 composite grades for both gold and copper. DD comprising PQ, HQ3, and NQ3 diameter core.

Newcrest - Independent Technical Specialist's Report

Grant Samuel & Associates Pty Ltd

0223041

Drillhole collars were surveyed at completion of drilling. Down-hole surveys were conducted during drilling with a single-shot gyroscopic downhole tool at 15 m to 30 m intervals. A multi-shot tool is used at completion of each drillhole.

DD logging includes geological including lithology, mineralization, structure, and geotechnical parameters. Logging data is entered into an acQuire database and validated.

DD core was logged on 1 m intervals until 2000 and on geological intervals more recently. Drill core was digitally photographed before being cut and sampled. Drill core is sampled and analysed on 2 m intervals. Newcrest monitored core recovery against grade with no material issues reported.

Half-core samples are routinely taken, with sample preparation occurring at Newcrest's laboratory in Orange. Procedures followed accepted industry practice of oven drying at 105°, crush to <2 mm and pulverizing 2.5 kg to a standard of 95% passing 106 µm.

Assaying was performed at recognised third party laboratories until 2010. Newcrest Services Laboratory has been used since with third party checks performed. Various accepted industry assay methods are used for the different elements, noting that fire assay charges for gold were 30 g or 50 g, and 50 g is preferred.

Bulk density determinations occurred every 20 m to 50 m as part of the logging process by Newcrest staff. Bulk density is calculated using wet and dry weights. Results are estimated in the block model using inverse distance squared (ID²).

Data is stored in a secure acQuire database. Validation checks are performed commensurate with industry practices.

Documentation of quality assurance/quality control (QA/QC) results from all generations of drilling reported acceptable QA/QC results with assay accuracy and laboratory precision within acceptable limits.

2.3.3.2 Cadia East Mineral Resource estimation

The resource model is based on gold and copper domains within an outer copper grade shell. Internally three domains: one above the Carb 2 fault, and below the Carb 2 fault, east and west of the Ca_La, Cat, and Church faults.

Grade estimation was carried out using ordinary kriging (OK) into a block model using assays composited to 10 m intervals. Data was declustered. The block model parent cell dimensions were 20 mE by 20 mN by 20 mRL, and discretised, due to the nature of the mineralisation and mining selectivity.

Grade caps were applied to silver, molybdenum, and sulphur.

Variograms were calculated and modelled for all estimated variables using an earlier version of the database. The influence of the most recent drilling was considered by Newcrest to not be material to the outcomes of the analysis based on the amount of data already present. Gaussian transforms are used for the variogram assessment.

Kriging Neighbourhood Analysis (KNA) is performed on all domains and elements using proprietary software to optimise search parameters. Soft boundaries with 30 m applied to all elements in all domains. AMC considers the search data to be reasonable for the scale of the mineralisation.

Density was estimated in mineralization domains using ID² estimation.

Newcrest - Independent Technical Specialist's Report

Grant Samuel & Associates Pty Ltd

0223041

The block model was validated by visual and statistical comparison of model grades and informing data, by graphical representation of model and data grade trends in swath plots and by direct block simulations that analyse local volume variability. The Mineral Resource was reviewed by independent consultants.

The Cadia East Mineral Resource estimate was classified as Indicated and Inferred Mineral Resource in line with the JORC Code. The classifications considered confidence in geological and grade continuity, and the reasonable prospects of eventual economic extraction based on calculations of NSR.

The Mineral Resource estimate is reported above an NSR cut-off of A\$18/t milled to establish JORC Code requirement of reasonable prospects of eventual economic extraction (RPEEE). Mineral Resources are reported inclusive of Ore Reserves.

2.3.4 Ridgeway Mineral Resource

The Ridgeway mineralisation is defined in a copper gold quartz veining zoned in a monzonite to quartz-monzonite plug 50 m to 100 m in diameter that has intruded the FRV. There is a disseminated copper rich chalcopyrite zone above a quartz vein-hosted gold rich zone. This is cut by the Claudia Fault. The mineralisation is as stockwork and sheeted quartz sulphide veins within a broadly stratabound zone associated with the monzodiorites.

2.3.4.1 Data collection

Drilling at Ridgeway consists of over 600 DD. DD comprising PQ, HQ, and NQ and LTK60 diameter core. Six drillholes are excluded due to issues with spatial control.

Drillhole collars were surveyed at completion of drilling by GPS or underground survey. Down-hole surveys were conducted during drilling with a single-shot, multi-shot and gyroscopic downhole tool. A gyroscopic tool is used at 5 m intervals at the completion of each drillhole.

DD logging includes geological including lithology, alteration, structure and geotechnical parameters. Logging data is entered into an acQuire database and validated.

DD core was logged on 1 m intervals until 1998 and on geological intervals more recently. Drill core was digitally photographed before being cut and sampled. Drill core is sampled and analysed on 2 m intervals. Core loss is reported by Newcrest to be only minor zones, with generally 100% recovery.

Half-core samples are routinely taken, with sample preparation procedures following accepted industry practice of crushing and pulverizing to a standard of 95% passing 75 µm.

Assaying was performed at recognised third party laboratories until 2010. Newcrest Services Laboratory has been used since with third party checks performed. Various accepted industry assay methods are used for the different elements, noting that fire assay charges for gold of 50 g is acceptable.

Bulk density determinations occurred every 50 m, or more frequently if required, as part of the logging process by Newcrest staff. Bulk density is assigned to each of the seven gold estimation domains. These domains follow lithology closely.

Data is stored in a secure acQuire database. Validation checks are performed commensurate with industry practices.

Documentation of QA/QC results from all generations of drilling reported acceptable QA/QC results with assay accuracy and laboratory precision within acceptable limits.

Newcrest - Independent Technical Specialist's Report

Grant Samuel & Associates Pty Ltd

0223041

2.3.4.2 Ridgeway Mineral Resource estimation

The resource model is based on lithology and structure within a 0.2 g/t Au grade shell.

Grade estimation was carried using OK into a block model using assays composited to 4 m intervals. Data was declustered. The block model parent cell dimensions were 25 mE by 25 mN by 25 mRL, and discretised, due to the nature of the non-selective mining methods of sub-level caving (SLC) and block caving. No grade caps were applied.

Variograms were calculated and modelled for all estimated variables. KNA is performed on all domains and elements using proprietary software to optimise search parameters. Density was allocated to domains as an average.

The resource model was validated by filtering for un-estimated blocks, visual and statistical comparison of model grades and informing data in each domain, and by graphical representation of model and data grade trends in slices through the model. The Mineral Resource estimate was independently reviewed in 2010 with no material issues reported.

The Ridgeway Mineral Resource estimate is classified based on drillhole spacing, grade continuity, elevation, A\$12.50/t NSR and geological knowledge as Indicated and Inferred Mineral Resource in line with the JORC Code. The classifications considered an assessment of variogram continuity and extension variance method. Indicated and Inferred are defined by weighted distances within 60 m and 100 m respectively.

The Mineral Resource estimate is reported within an NSR shell to establish JORC Code requirements of RPEEE. Mineral Resources are reported inclusive of Ore Reserves.

2.3.5 Cadia Extended Underground Mineral Resource

The Cadia Extended Underground (UG) mineralisation is hosted within a monzonite porphyry and in adjacent wall rock, adjacent to the FRV contact. The mineralisation is in sheeted, sulphide rich quartz veins, as fracture fill and disseminated. Lodes of higher-grade pegmatite occur associated with the porphyry mineralisation.

2.3.5.1 Data collection

Drilling at Cadia Extended UG consists of 70,820 m of DD drilling providing 38,047 samples and 22,243 m of RC drilling for 11,120 samples used for the Mineral Resource estimation.

Drillhole collars were surveyed at completion of drilling. Down-hole surveys were conducted during drilling with a single-shot electronic surveys at 50 m intervals. Alternatively conventional borehole camera or gyroscopic tool were used.

DD logging includes geological including lithology, alteration, structure, and geotechnical parameters. Logging data is entered into an acQuire database and validated.

Drill core was digitally photographed before being cut and sampled. Drill core is sampled and analysed on 1 m or 2 m intervals. Core recovery averaged approximately 99%.

Half-core samples are routinely taken. Sample preparation and analysis has occurring at recognised commercial laboratories, and later as Newcrest's laboratory in Orange. Procedures followed accepted industry practice of oven drying at 105°, crush to <2 mm and pulverizing 3 kg to a standard of 90% passing 75 µm.

Accepted industry assay methods are used for the different elements. Fire assay charges for gold were 50 g. Copper used inductively coupled plasma (ICP) with copper cyanate determined by Newcrest standard procedures.

Newcrest - Independent Technical Specialist's Report

Grant Samuel & Associates Pty Ltd

0223041

Bulk density determinations used the water immersion method, with 1,030 measurements taken. The average bulk density was used for the monzonite and volcanics. The sediments and oxide were assigned bulk densities from Cadia East due to the small populations of data at Cadia Extended UG.

Data is stored in a secure acQuire database. Validation checks are performed commensurate with industry practices.

Documentation of QA/QC results from all generations of drilling reported acceptable QA/QC results with assay accuracy and laboratory precision within acceptable limits and at an appropriate frequency.

2.3.5.2 Cadia Extended UG Mineral Resource estimation

The resource model is based on domains developed for lithology, oxidation, structure and copper mineralisation using Leapfrog's implicit modelling function. These were then combined to create six estimation domains.

Grade estimation was carried using OK into a block model using assays composited to 10 m intervals. The block model parent cell dimensions were 12.5 mE by 12.5 mN by 15 mRL. Data was declustered. Grade caps were applied to gold, copper, and molybdenum.

Variograms were calculated and modelled for all estimated variables using pairwise variograms. KNA is performed on all domains and elements using proprietary software to optimise search parameters.

The resource model was validated by a nearest neighbour (NN) estimate on uncapped data. Other validations included visual, statistical, swath plots and a Direct Gaussian model. The Mineral Resource was independently reviewed by a specialist consultant.

The Cadia Extended UG Mineral Resource estimate was classified as Indicated and Inferred Mineral Resource in accordance with the JORC Code. The classifications are based on continuity and quality of data, scale, and an assessment of the relative uncertainty of <15% for a 90% confidence level at defined drillhole grids to support Indicated Mineral resource classification.

The Mineral Resource estimate is reported within a notional block cave based on a range of stope heights and minimum diameter and draw schedule constraints. Mineral Resources are reported inclusive of Ore Reserves.

2.3.6 Big Cadia Mineral Resource

The Big Cadia East mineralisation occurs as a skarn hosted in an altered bedded volcanoclastic unit. The structure is complex. The mineralisation is magnetic. There is historic and recent (Newcrest) drilling information.

2.3.7 Data collection

Drilling at Big Cadia consists of over 78,152 m of DD, RC and rotary air blast (RAB) drillholes. RAB drilling is not used for the Mineral Resource estimate.

Drillhole collars were surveyed at completion of drilling by GPS or survey. Down-hole surveys were conducted during drilling with a single-shot Eastman camera outside of the magnetic skarn. A gyroscopic tool has been used since 2004.

DD geological logging includes lithology, alteration, structure, and geotechnical parameters. Logging data since 2005 is entered into an acQuire database and validated.

Newcrest - Independent Technical Specialist's Report

Grant Samuel & Associates Pty Ltd

0223041

Core recovery averaged 86% in oxide and 99% in fresh material. DD core and RC was sampled and analysed on 1 m intervals, except PQ core sampled on 0.5 m intervals.

Half-core samples are routinely taken. Sample preparation has varied over time but generally follows accepted industry practice of crushing and pulverizing to a standard of 95% passing 75 µm.

Assaying was performed at recognised third party laboratories. Various accepted industry assay methods were used with acceptable detection limits.

Bulk density determinations occurred in one drilling series. Weighted average values are assigned to each lithology.

Data is stored in a secure acquire database. Validation checks are performed commensurate with industry practices.

Documentation of historic QA/QC results is absent or unreliable. Pre Newcrest data is of insufficient standard and carries risk of being misleading. However, the data from all generations of drilling are used. The risk of data quality was over-ridden by the need to include the data in areas devoid of Newcrest drilling. The Newcrest data reported acceptable QA/QC results with assay accuracy and laboratory precision within acceptable limits.

2.3.7.1 Big Cadia Mineral Resource estimation

The resource model is based on domains developed for lithology, oxidation and structure using Leapfrog's implicit modelling function. These were then combined to create nine estimation domains.

The resource model is based on lithology and structure within a 0.2 g/t Au grade shell.

Grade estimation was carried using OK into a block model using assays composited to 4 m intervals. Data was declustered. The block model parent cell dimensions were 25 mE by 25 mN by 5 mRL, and discretised to 6.25 mE by 6.25 mN by 2.5 mRL. Grade caps were applied to all key elements estimated.

Variograms were calculated and modelled for all estimated variables. KNA is performed on all domains and elements using proprietary software to optimise search parameters. AMC considers the search data to be reasonable for the scale of the mineralisation. Density was allocated to domains as weighted averages.

The resource model was validated by a NN estimate, visual and statistical assessment, swath plots and a Direct Gaussian model. The Mineral Resource was independently reviewed in 2015 with no material issues reported by Newcrest.

The Big Cadia Mineral Resource estimate is classified based on an estimated value incorporating the forecast revenue streams for gold and copper. The resource is constrained within a mining shell sourced from a 2016 file. Despite reasonable data density, classification of the Mineral Resource estimate has been downgraded to Inferred to account for the data that cannot be demonstrated to meet the QA/QC requirements.

The Mineral Resource estimate is reported by Newcrest as being within an NSR shell to establish JORC Code requirements of a Mineral Resource requiring RPEEE. Mineral Resources are reported inclusive of Ore Reserves.

2.3.8 AMC comments on the Mineral Resources estimates

AMC was provided with the 2022 Mineral Resources estimate at Cadia for the purposes of preparing the ITSR. Subsequently AMC was provided with the 2023 Mineral Resource tonnages

Newcrest - Independent Technical Specialist's Report

Grant Samuel & Associates Pty Ltd

0223041

and grade. These are very similar to 2022, reflecting depletion as the only change. AMC's comments relate to the review of the 2022 Mineral Resource estimate. AMC has not reviewed information from 2023, but anticipates the outcomes of a review will be the same as for 2022.

The Ridgeway Mineral Resource estimate is based on a block model that was estimated in 2009. Newcrest reports that it has undertaken a sensitivity analysis against current economic assumptions that confirms the Mineral Resource remains economic. Therefore, Newcrest used these assumptions for the 2022 Mineral Resource estimate.

The 2022 Cadia Extended Mineral Resource estimate is based in a block model that was estimated in 2015. Newcrest reports that it undertook a sensitivity analysis against current economic assumptions that confirmed the Mineral Resource estimate remained economic. Therefore, Newcrest used these assumptions for the 2022 Mineral Resource estimate.

The Cadia East Mineral Resource was estimated in 2021 and independently reviewed the same year with no material or non-material issue reported. The cost assumptions used to determine the NSR cut-off grade were from December 2020.

The 2022 Big Cadia Mineral Resource estimate is based on a block model that was prepared in 2015. Newcrest reports that it undertook a sensitivity analysis against current economic assumptions that confirmed the Mineral Resource estimate remains economic. Therefore, Newcrest used these assumptions for the subsequent Mineral Resource estimate.

Drilling, sampling, assaying and other acquisition of other data used for estimations of the Mineral Resources have been collected following accepted industry practice and established protocols. Assay data used for grade estimation is generally supported by QA/QC procedures that follow accepted industry practice.

The Mineral Resource estimates are based on a geological interpretation that reflects the geological control on grade distribution.

Each Mineral Resource estimate followed accepted industry practice. In particular, the Cadia East Mineral Resource estimate, which makes up most of the total estimate of Mineral Resources was prepared following accepted industry practices and is appropriately classified as Indicated and Inferred Mineral Resource in accordance with the JORC Code.

Swath plots of drillhole composites plotted against block model grades were reviewed and confirmed the models correlate with the input data in location and scale.

The Mineral Resources estimates are appropriate to be used as the basis for Ore Reserve estimation.

2.3.9 Exploration and resource potential

Exploration has been extensive over a long period of time. This has identified a significant Mineral Resource inventory at Cadia of over 3,300 Mt, with 2,600 Mt of this at Cadia East. The AMC production cases utilise about one third of the Cadia East Mineral Resource estimate over a 27-year period. Therefore, a significant portion of the known Mineral Resources, which includes some Ore Reserves, sits outside the AMC production cases. Additional infill drilling within the known resource footprints is planned for optimising cave shapes and potentially reducing volume and increasing grade.

Since the early 1990s, exploration has evolved from, traditionally, a search at shallow depths identifying multiple deposits, to a focus on targets at depths around 2,000 m, as shown in Figure 2.7. The targets at Cadia considered by Newcrest to be opportunities are:

- Cadia East Deeps
- Ridgeway Deeps

Newcrest - Independent Technical Specialist's Report

Grant Samuel & Associates Pty Ltd

0223041

- Holeman's Lode
- Big Cadia
- Cadia East PC1-4
- Cadia Far East
- Tunbridge Well
- Cadia East High-grade
- White Engine/Ridgeway South
- Forrest Reefs
- Cadia North East
- Garraways
- Barton Park/Rowan Brae

At Junctions Reef, there are multiple targets. The first of these targets is the Warrengong Corridor. This has multiple geochemical anomalies within an evolving geological model for the district.

Figure 2.7 Cadia exploration history

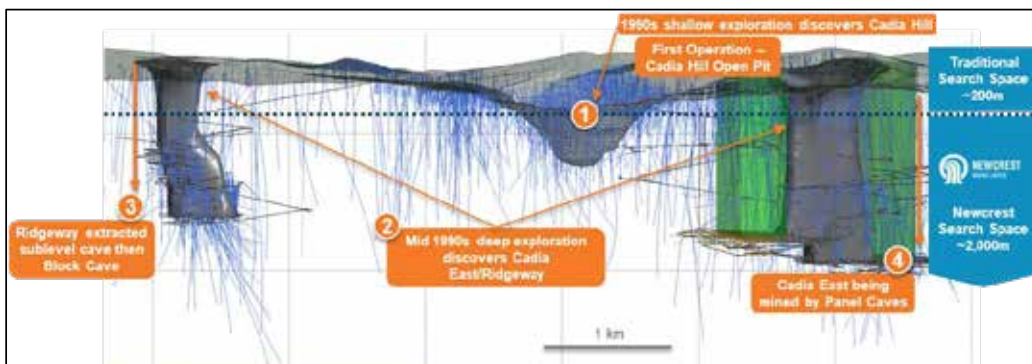

Source: Newcrest

2.4 Geotechnical investigations

Newcrest is considered the industry leader in developing deep level caving operations in good-quality rock masses. Successful development of the Ridgeway block cave (below the Ridgeway sublevel cave) was followed by the development of the PC1 and PC2 panel caves at Cadia East which have been brought into production successfully at unprecedented depth. Technical innovations, in particular rock mass preconditioning by both blasting and hydraulic fracturing have been critical to ensuring reliable cave initiation and propagation to surface.

Comprehensive geotechnical investigations have been undertaken to meet the requirements of Newcrest's study stage-gating process, for the next two caves that are required to maintain production at current levels as PC1 and PC2 approach completion.

PC2-3 is being implemented with primary development complete and undercutting and drawbell establishment in progress.

PC1-2 has been studied at full FS level. The study has been subject to regular reviews by Newcrest's Caving Advisory Panel whose membership comprises internationally recognized caving experts.

Geotechnical data is collected from the rock-mass that comprises the Cadia East orebody and surrounding host rocks. The data is predominantly collected from a series of diamond drill holes.

Annexure 1. Independent Expert's Report

Newcrest - Independent Technical Specialist's Report

Grant Samuel & Associates Pty Ltd

0223041

The data comprises:

- Rock Mass Rating (RMR90).
- Q and Q' (Q Prime) values.
- Geological Strength Index (GSI).

These rock-mass parameters are determined by detailed core logging, systematic point load testing of core, and laboratory testing. An overall geotechnical block model has been created for the Cadia East underground mining area. This model allows for a detailed understanding of the rock mass and its likely response to the cave mining process and provides inputs for numerical modelling and fragmentation assessment.

Numerical modelling has been undertaken to investigate the response to undercutting and cave propagation, with a particular focus on the life-of-mine infrastructure including the crushers, conveyor declines and ventilation shafts. Some areas are predicted to experience Class II damage (excavations serviceable but requiring rehabilitation) as shown in Figure 2.8 and Table 2.4. Only the 5050 Perimeter Drive is predicted to experience Class III damage (excavation no longer serviceable) in FY30, at which stage it may no longer be required.

Figure 2.8 Predicted damage classes for critical underground excavations at FY48

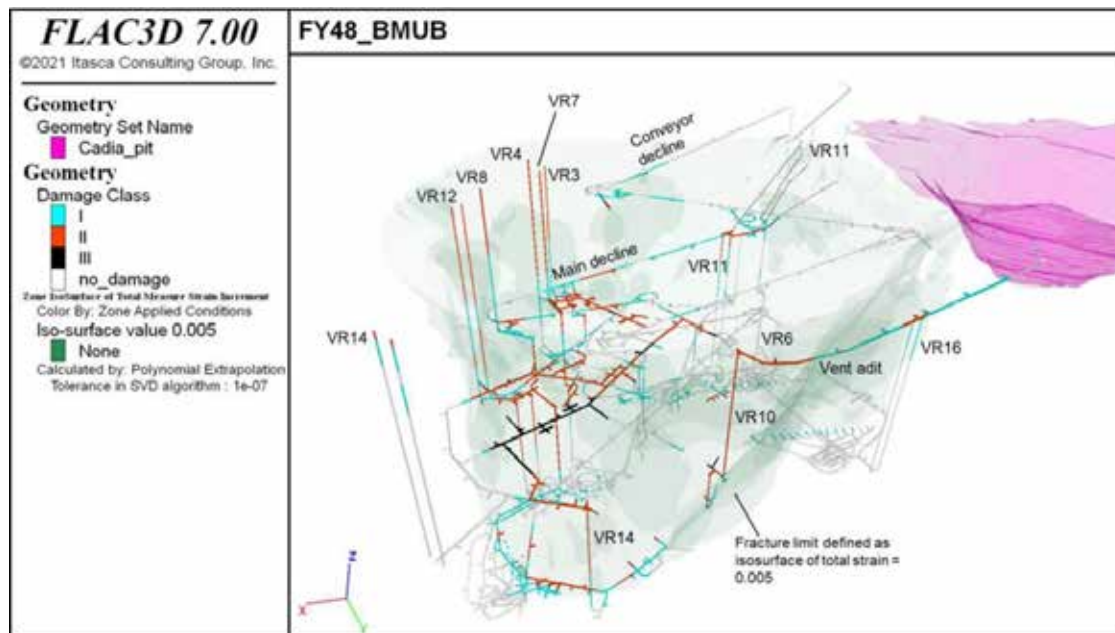

Table 2.4 Damage level forecast for critical underground infrastructure

Infrastructure	Class II	Class III
VR3	FY23	-
VR8	FY30	-
VR10	Prior to FY21	-
VR11	FY32	-
VR14 Bottom Leg	FY26	-
Conveyor Decline	-	-
5050 Perimeter Drive	Prior to FY21	FY30
VR10 Adit	Prior to FY21	-

Newcrest - Independent Technical Specialist's Report

Grant Samuel & Associates Pty Ltd

0223041

Modelling also identified concerns with the crusher stations, in particular the southern PC1-2 crusher and associated bins where deviatoric stresses are predicted to reach 140 MPa. Mitigation plans include the use of 'lightweight cellular concrete' to protect structures such as the bin liners from excessive deformation. AMC comments that there has been limited experience in applying this approach in underground, high stress environments. Hydrofracking is also proposed in the vicinity of major LOM infrastructure, targeting some of the structures and intrusives considered to present an elevated risk of generating large seismic events. An unexpectedly large seismic event could result in damage to the crushers, associated infrastructure or parts of the extraction levels. If it happens, an outage of 2-3 months would be typically required to effect repairs and support rehabilitation.

AMC considers that the crushers and associated infrastructure, due to their proximity to the cave, are moderate risk. Newcrest has applied its experience with PC1 and PC2 to developing support standards that are expected to manage the associated deformation and seismic hazards.

There is a high level of confidence that the PC2-3 and PC1-2 panel caves will propagate to surface. The modeling incorporated the effects of preconditioning and confirmed that this is critical to managing cave growth and propagation in a controlled manner whilst mitigating the formation of pillars against the existing caves which could result in large scale seismic events, such as occurred during the mining of PC2.

Similar numerical modeling studies will be required in future study phases to assess the likely effects of the other cave panels being considered in the current mine plan.

Modelling was also used to assess the cave propagation to surface and the likely surface subsidence effects. The modelling indicated that the effect of preconditioning improves cave propagation to surface and helps to maintain a near-vertical draw zone, in turn helping to protect and minimise damage to rock mass between the cave and the Cadia Hill open pit (Figure 2.9). It is important to avoid potential interaction with the pit as it is currently being used as a tailings storage facility (TSF).

Figure 2.9 Predicted fracture limit and mobilised zone at the end of the LOM

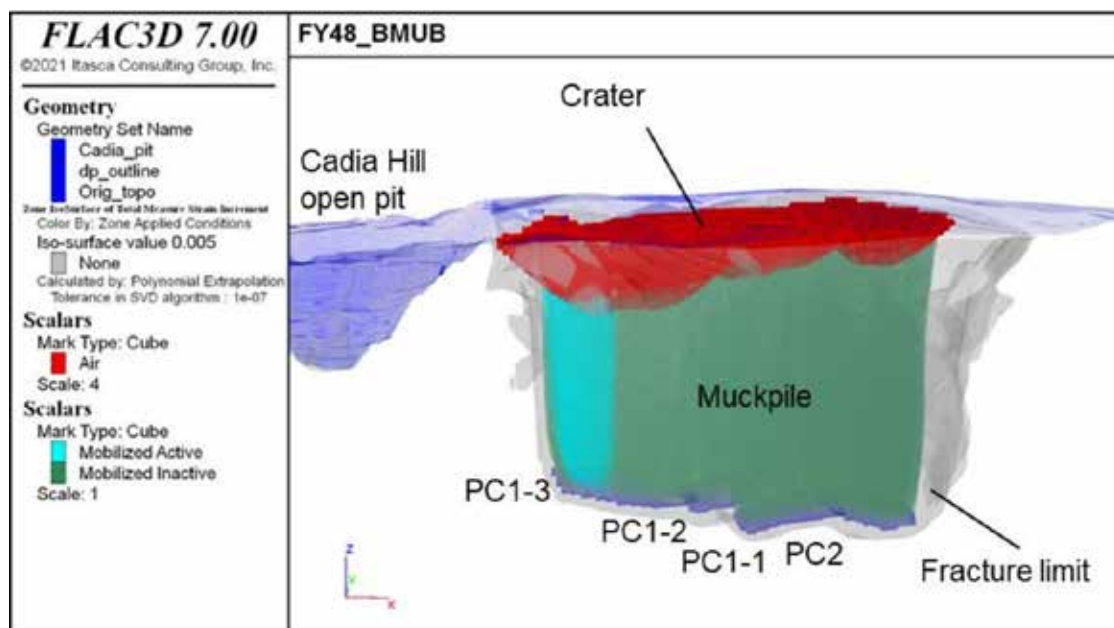

Newcrest - Independent Technical Specialist's Report

Grant Samuel & Associates Pty Ltd

0223041

Notwithstanding Newcrest's considerable experience with cave mining, and with local conditions and rock mass response at Cadia East, accurately predicting the outcomes of a mining operation of this scale is challenging. This is recognized by Newcrest and a comprehensive geotechnical monitoring programme is planned for PC1-2, as shown in Figure 2.10. It is critical that this is implemented to ensure that any significant departure from the expected local and regional response can be identified at early stage and appropriate mitigation strategies can be developed and implemented.

Figure 2.10 PC1-2 and PC1-3 geotechnical monitoring programme summary and breakdown

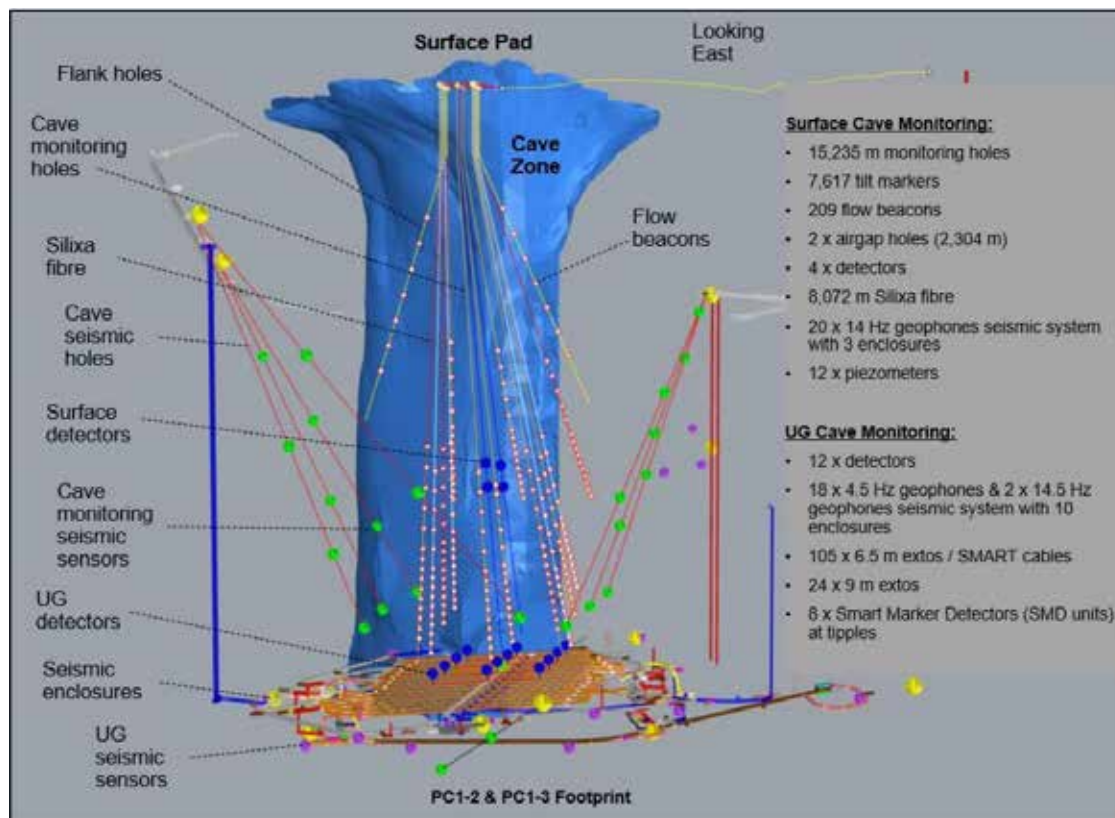

2.5 Mining operations and Ore Reserves

2.5.1 Mining Methods – Cadia East Operations

The mining method applied at Cadia East is panel caving, a variant of block caving. The mining method involves inducing caving of the rock mass by undercutting a block of ore. Mining proceeds by progressively advancing an undercut level beneath the block of ore. Above the undercut level, the overlying rocks are pre-conditioned by blasting and/or hydraulic fracturing resulting in consistent progression of the fracturing of the caving ore block as it is mined.

Following pre-conditioning, broken rock is removed through an extraction level, which is developed below the undercut level. The extraction level is connected to the undercut level by draw-bells that open into draw-points from which the broken rock is removed. Load-haul-dump (LHD) units load the broken ore at the draw-point and dump the material into underground crushing stations.

At each crushing station, ore is tipped into a coarse ore bin, which then feeds the crusher. Crushed rock is then fed to a surge-bin which regulates the flow of crushed rock onto collection

Newcrest - Independent Technical Specialist's Report

Grant Samuel & Associates Pty Ltd

0223041

conveyor belts. The collection belts then feed crushed rock onto the main trunk belt system, which transports ore to the surface at a rate of between 4,600 to 5,150 tonnes per hour. The main trunk belt extends approximately 7,500 m to the surface, depositing material on the concentrator coarse ore stockpile. The coarse ore is then gravity fed into the surface ore processing system.

Waste rock is removed from the underground workings by truck via the decline and dumped at the South Waste Rock Facility.

Fresh air enters the underground workings via the main and conveyor declines and ventilation intake shafts. Return air is removed from the workings by vertical shafts and exhaust fan installations. Groundwater and service water is collected by a series of sumps and drain-holes and then pumped to surface.

Cadia East is supplied with electrical power by a 132 kV transmission line feeding two 33kV ring-main feeders to the underground mine.

Blasting consists of development blasting and production blasting to mine the access tunnels, infrastructure and production excavations. Emulsion explosives are generally used, and occasionally ammonium nitrate fuel oil is used. Hydraulic fracturing is used to augment the caving process.

2.5.2 Current mining operations

There are two main stages of an active cave operation: the development phase and the production phase. The development phase refers to the early stage of mining. Significant initial capital expenditure occurs with little to no ore production. Significant lateral and vertical development, along with construction of large-scale infrastructure occurs within this period.

From Newcrest advice and review of mine plans, the duration of the development phase typically lasts six to seven years as has been achieved in previous panel establishments at Cadia. Producing block caves typically have minimal capital expenditure requirements (sustaining capital) and have work activities associated with extraction of ore from the cave footprint.

All current and future panel caves are designed as post undercut caves with an El Teniente layout. The El Teniente layout is a quadrilateral configuration of extraction from a cave operation. This is a commonly applied methodology in the international mining industry, named after the El Teniente operations in Chile, where this mining method is applied. The resultant pillars are stronger than those in the commonly used alternative 'herringbone' layout and hence generally preferred in high stress conditions.

An indicative ore production profile from current and future planned caves is presented in Figure 2.11.

Annexure 1. Independent Expert's Report

Newcrest - Independent Technical Specialist's Report

Grant Samuel & Associates Pty Ltd

0223041

Figure 2.11 Cadia - indicative ore production profile

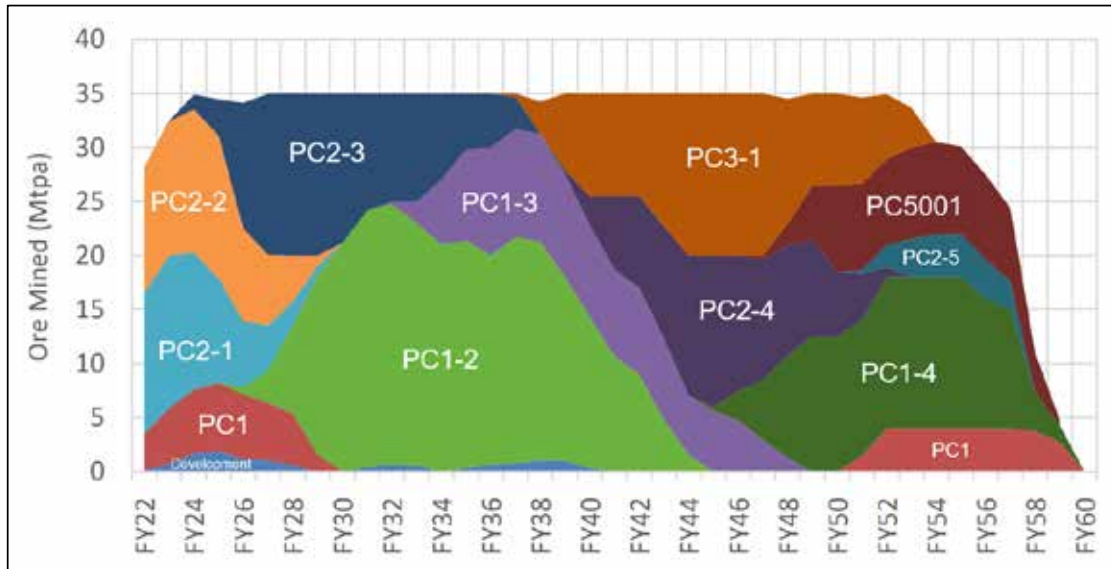

Current mining operations in production at Cadia East consist of three mature panel caves and two developing panel caves. Current and future planned caves are shown in Figure 2.12.

Figure 2.12 Cadia - view of active and future stages of caving.

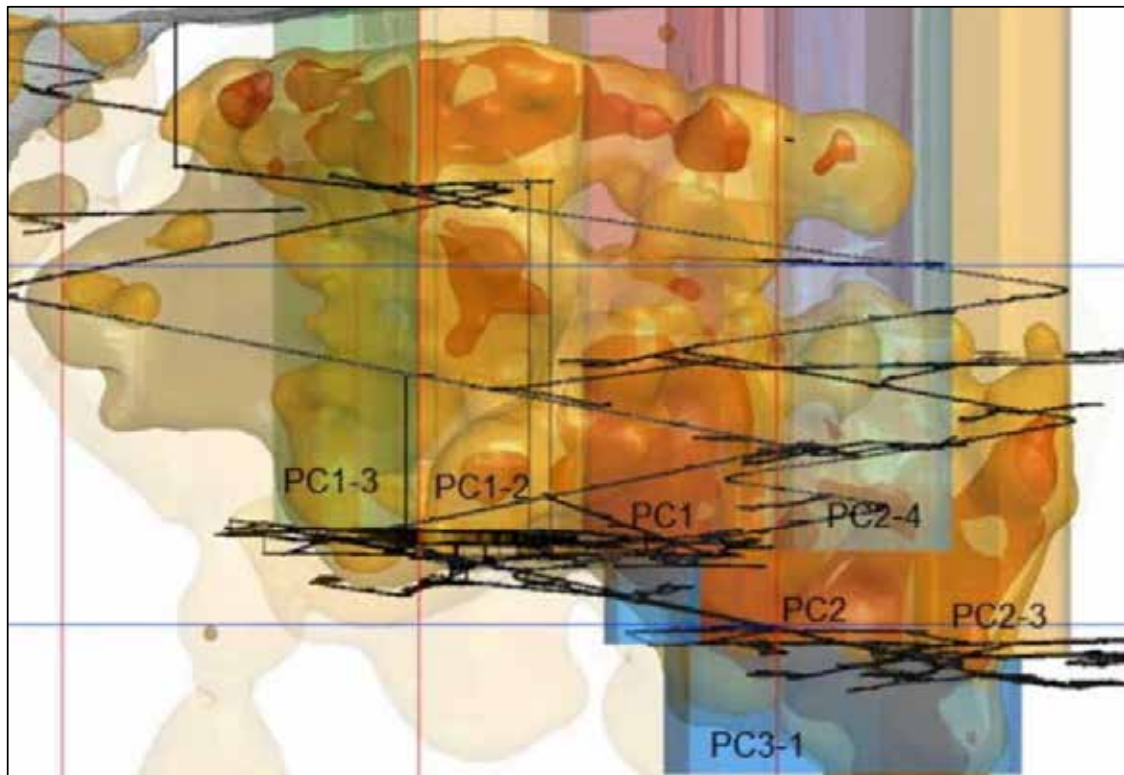

Newcrest - Independent Technical Specialist's Report

Grant Samuel & Associates Pty Ltd

0223041

2.5.2.1 Caves in production

PC1-1, PC2-1 (PC2-West), and PC2-2 (PC2-East) are in production and have been for some time.

PC1-1 is the original caving front for Cadia East and is located at 4,650 mRL (approximately 1,180 m below surface). It is now automated with minimal access to the cave footprint to manage caving subsidence and in-rush hazards. Production from PC1-1 is forecast to be completed by FY29 with a relatively consistent average annual production rate of approximately 5.2 Mtpa until the end of life. The extraction level is designed on an El Teniente layout. Production ore is loaded from seven extraction drives through four tipples into a single crusher. Ore is transported to surface via the Materials Handling System (MHS).

PC2-1 and PC2-2 are located 200 m deeper, at 4,450 mRL, with PC2-1 having a breakthrough connection to the eastern portion of PC1-1 ensuring caving fronts merge. Both PC2-1 and PC2-2 are mined on an El Teniente mining layout each with their own independent crusher, supplied via a four-way tipple. The two caves support seven independent extraction drives with one additional common extraction drive in the middle.

PC2-1 is forecast to finish mining in FY29 with a peak production of approximately 14 Mtpa in 2023, tapering to closure. PC2-2 is forecast to finish in FY28 with an equivalent peak of approximately 14 Mtpa with a shorter taper to closure. The eastern extent of PC2-2 adjoins the future caving front PC2-3 discussed below.

2.5.2.2 Caves under development

Cadia East has two developing caves; PC2-3 and PC1-2. These assets are the next production zones required to supply ore to the mill. Both PC2-3 and PC1-2 have full feasibility studies completed to a high level of detail.

PC2-3 is being developed as a post undercut cave utilizing blast pre-conditioning as well as hydrofracking to facilitate caving. Total production from the cave is 146 Mt with an annual production capacity of 15Mtpa. Ore is mined from 154 drawbells and a 98,000 m² footprint. To date, it has the bulk of development completed, with crushing infrastructure fully commissioned. Materials handling for PC2-3 is supported by a single crusher, located on the East of the footprint. The undercut commences from the north-western boundary of PC2-3 alongside PC2-2. Footprint development on the undercut is complete, with considerable development completed on the extraction level. Primarily late-stage extraction development and lagging extraction drives remain to be completed. Draw bell firings have begun and are ongoing, with undercutting having also commenced. First undercut firing commenced in March-23 compared to the feasibility planned start date of September-2022. The revised draw bell and undercut firings completion is forecast for January-2026.

PC1-2 is a post-undercut cave utilizing blast pre-conditioning as well as hydrofracking to facilitate caving. Total production from the cave is 280 Mt with an annual production capacity of 24 Mtpa from 146 draw bells and a 115,600 m² footprint. The cave requires approximately 32 km of lateral development. It contains common capital development that enables PC1-3 to take place in future. Main works development has commenced, with development forecast to be completed in January 2027. PC1-2 adjoins PC1 (to the East) and consists of nine extraction drives, the most eastern of which breaks into PC1. PC1-2 is supported by two crushers on the north and south of the footprint. The design throughput for the MHS is 36 Mtpa including support for the deferred PC1-3 to be mined concurrently. Production is forecast to commence in FY26.

2.5.3 Future mine expansion

PC1-3 covers 55,000 m² of footprint inside the capital development bounds of the PC1-2 feasibility study. Production from PC1-3 is deferred to meet underground production requirements. Five extraction/undercut drives, encompassing 61 drawbells, are deferred until FY31, whilst not being required to meet production targets until FY32. The PC1-2 north and

Annexure 1. Independent Expert's Report

Newcrest - Independent Technical Specialist's Report

Grant Samuel & Associates Pty Ltd

0223041

south crushers are designed to support this deferred region, with additional tip heads included at the tipple as part of the original design scope. The entirety of PC1-3 production is within the Newcrest LOMP.

PC3-1 is the lowest planned cave at Cadia East at 4,185 mRL. Footprint area is 95,000 m² supported by 19 extraction drives containing 156 drawbells. First production tonnes are forecast to commence in approximately FY36. The cave requires approximately 28km of lateral development and 1km of vertical development. Access to the footprint is via three spiral declines supporting access for development and a production haulage loop. PC3-1 plans to utilize truck haulage from the footprint to the existing PC2-3 crusher to connect with the existing MHS. The Newcrest LOMP does not include all the Ore Reserve at this horizon.

PC2-4 is a cave located approximately 50m above the PC1-1 cave footprint and to the south of the PC2 cave, interacting with all 3 other footprint extents, higher in the caved column. It has an approximate footprint of 52,000 m² supported by 15 extraction drives containing 162 drawpoints. The cave requires approximately 15 km of lateral development and approximately 1.7 km of vertical development. PC2-4 plans to utilize truck haulage from the footprint to the existing PC1-1 crusher via an ore pass and rehandle to the PC1 tipple. AMC notes that the PC1-1 crusher will have an inactive period between PC1-1 completion and PC2-4 production start, of approximately 10 years. The Newcrest LOMP does not include all the Ore Reserve at this horizon.

PC2-5 is a small extension to the west of PC2-1, which lies approximately 160m underneath PC1-1 and caving will consume part of the PC1-1 footprint, well after PC1-1 closure. It consists of four extraction drives containing 32 drawbells. The total footprint is approximately 19,000 m². Development required to establish the cave includes approximately 3.4 km of lateral development and approximately 40 m of vertical development.

Materials handling will utilize PC2-1 crusher. AMC notes that the PC2-1 crusher will have an inactive period between PC2-1 completion and PC2-5 production start, of approximately 16 years.

PC1-4 is a panel which lies to the north of PC1-1, PC1-2, PC1-3, and PC2-1. The PC1-4 extraction level lies approximately 40m above PC1-2 and PC1-3. The extraction level contains 25 extraction drives with 223 drawbells. The cave footprint area is approximately 149,000 m².

Materials handling for PC1-4 is via two streams. The main ore stream (supporting the bulk of the tonnes) will utilize a new crusher located centrally to the cave. Crushed material will be conveyed to a new transfer over the PC1-2 Northern crusher connecting conveyor. For a limited number of extraction drives, closer to the PC1-2 Northern crusher, material will be bogged to an ore pass and rehandled into the PC1-2 northern crusher.

The layout of the various panels within the Cadia East deposit is illustrated in Figure 2.13. The blue panels are within the Newcrest Investment Case. The red panels are remaining portions of the deposit beyond FY50.

Newcrest - Independent Technical Specialist's Report

Grant Samuel & Associates Pty Ltd

0223041

Figure 2.13 Cadia East panels

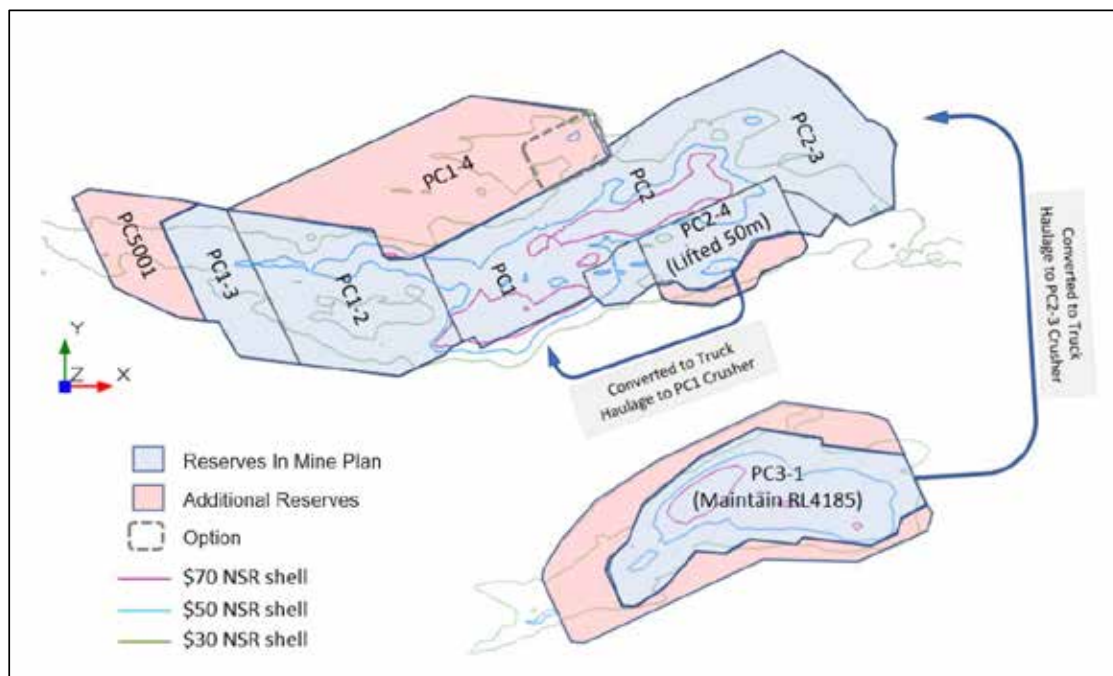

2.5.4 Ore Reserves and estimation process

Newcrest reported an Ore Reserve estimate for Cadia in June 2023, comprising Cadia East underground and Ridgeway underground. The Ore Reserve estimate is summarised in Table 2.5.

Table 2.5 Cadia Ore Reserve estimate as at 30 June 2023

Deposit and Classification	Tonnes		Grade			Contained Metal			
	Mt (Dry)	Au (g/t)	Cu (%)	Ag (g/t)	Mo (ppm)	Au (Moz)	Cu (Mt)	Ag (Moz)	Mo (Mt)
Cadia East Underground									
Probable	1,200	0.42	0.29	0.69	81	16	3.4	26	0.096
Ridgeway Underground									
Probable	80	0.54	0.28	0.66	-	1.4	0.23	1.7	-

Note: Ridgeway is currently on care and maintenance subject to further studies, all necessary approvals, permits, internal and regulatory requirements and further works.

The Cadia East Ore Reserve estimate employs a value-based cut-off determined from the NSR value equal to the site operating cost. The NSR calculation considers Ore Reserve revenue factors, metallurgical recovery assumptions, transport costs, refining charges, and royalty charges. The site operating costs include mining cost, processing cost, relevant site general and administration costs and relevant sustaining capital costs. The cut-off value used for the Cadia East Ore Reserve estimate was A\$22.70/t milled and \$22.40/t for Ridgeway.

Estimation of the Cadia East Ore Reserve involved standard steps of mine optimisation, mine design, production scheduling, and economic modelling. Factors and assumptions had been based on operating experience and performance of the existing Cadia operations.

Newcrest - Independent Technical Specialist's Report

Grant Samuel & Associates Pty Ltd

0223041

The following modifying factors have been applied to the Ore Reserve estimate:

- All development has mining factors for dilution and recovery applied.
- PCBC software was used to estimate grades of mined material as it is progressively drawn from the cave.
- The material flow parameters used in the draw modelling have been reconciled to existing measurements and performance,
- The height of the draw in each panel is high by industry standards and there is a risk to the mined grade estimate near the end of each panel.
- The capital and operating costs used in the Ore Reserve estimate have been based on current costs and from study estimates to, at least, a pre-feasibility study level of confidence.
- The revenue factors used in the estimate are based on long-term metal prices and exchange rate assumptions.
- Economic modelling of the Cadia East Ore Reserve estimate has demonstrated a positive value at a discount rate of 4.5% real.

2.6 Mineral processing

2.6.1 Processing plant description

Cadia currently consists of two operational concentrators handling significantly different amounts of ore at present. Concentrator 1 has undergone several upgrades since commissioning in 1998 and currently processes around 26 Mtpa ore using a conventional SABC circuit (SAG mill and ball mill with single stage pebble crusher). The inclusion of high-pressure grinding rolls and third train of flotation cells enables the circuit to treat ore from the Cadia East mine. Increasing throughput has required a coarser primary grind size (over with 80% <210 microns up from the original design of 80% <150 microns) and in order to treat the increased tonnage, as well as upgrading and including additional equipment into two of the three flotation trains. Concentrator 2 was commissioned in 2002 and with several upgrades has almost doubled its original capacity and now processes 9 Mtpa.

Major consumables include flotation reagents, lime, and flocculant (to assist with dewatering) as well as grinding media.

The processing plant uses a combination of recycled water (thickener overflows and TSF return water) and make-up water which is sourced from local dams and creeks as well as groundwater extraction bores.

Newcrest - Independent Technical Specialist's Report

Grant Samuel & Associates Pty Ltd

0223041

Figure 2.14 Simplified process flow sheet for Concentrator 1 & 2

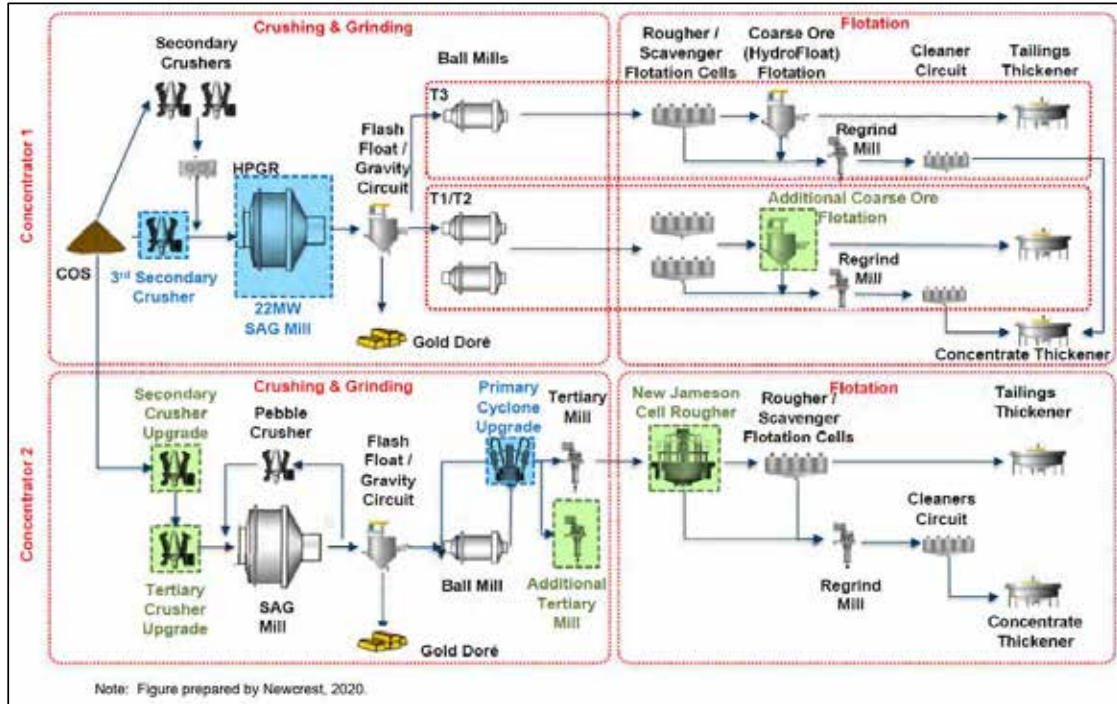

2.6.1.1 Molybdenum Plant

Cadia East orebody contains molybdenum which is present in the copper concentrate when recovering copper. The plant has been in operation since early 2022 and has not been fully commissioned. The current designs have a nominal feed rate of approximately 60tph of dry feed in order to produce a concentrate of greater than 52% molybdenum. A significant amount of engineering design work has allowed for flexibility in the flowsheet to allow for by-pass options etc. Work is continuing to develop engineering, geometallurgical and metallurgical options.

Sodium hydrogen sulphide is a key processing reagent for the capture and subsequent treatment of hydrogen sulphide gas (industry standard) in the separation of molybdenum from copper.

Newcrest - Independent Technical Specialist's Report

Grant Samuel & Associates Pty Ltd

0223041

Figure 2.15 Molybdenum Plant flow sheet

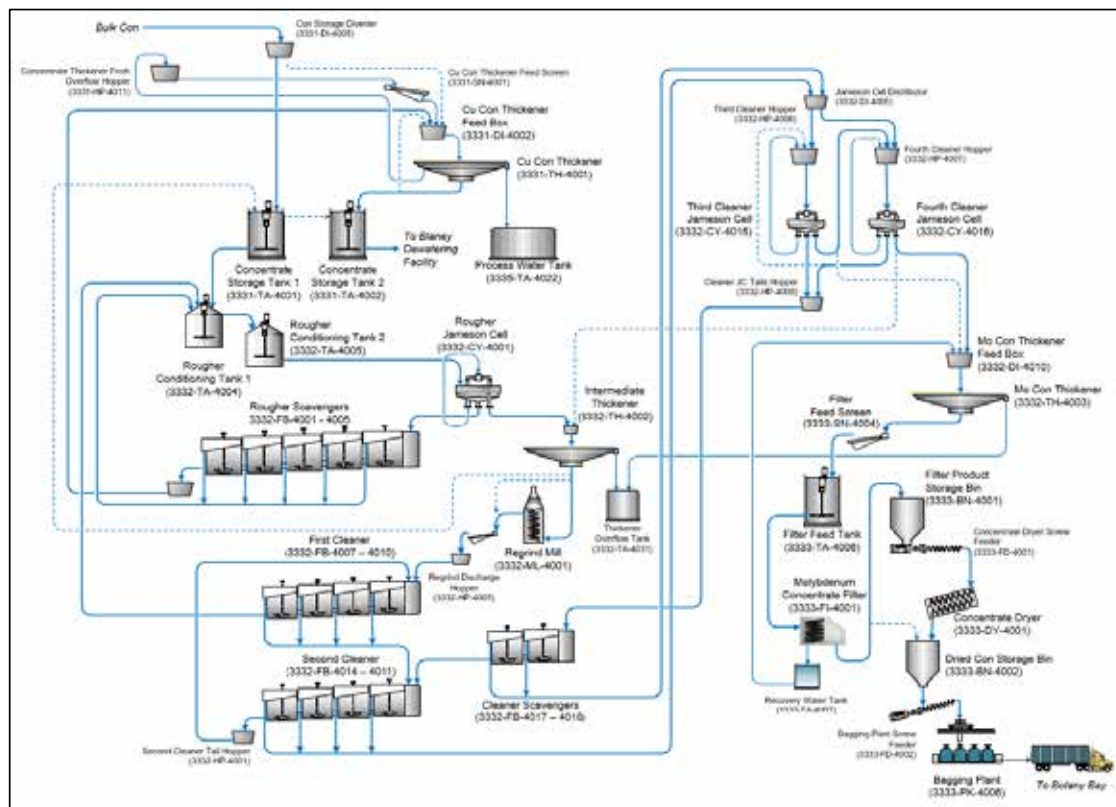

Summary of all major ore processing equipment includes:

- Concentrator 1:
 - Gyratory crusher with screening plant and two cone crushers for secondary crushing.
 - High Pressure Grinding Rolls (HPGR) made by Thyssen-Krupp AG (Polysius).
 - Secondary Crusher made by Metso (Nordberg).
 - SAG Mill - Metso (Svedala) gearless motor drive (Siemens) (20 MW), 40 foot diameter, with oversize pebbles returning to the screening plant.
 - 3 x ball mills in closed circuit, Metso, 2 x 22 foot diameter x 36 foot and 1 x 26 foot diameter x 42 foot.
 - Flash flotation cells and gravity concentrators for processing a component of the hydrocyclone underflow streams.
 - Three flotation trains comprised of conventional Outokumpu flotation cells in rougher-scavenger duties and a combination of Jameson cells and conventional cells in cleaner duties, and cleaner-scavenger and recleaner duties.
 - HydroFloat™ cells for coarse tailings flotation, with cross flow classifier made by Eriez.
 - 2 x Vertimills made by Metso for regrinding.
 - Tailings thickeners made by EIMCO 53 m and FLSmidth 40 m diameter.
 - Concentrate thickener made by Outokumpu Superflo 12 m diameter.
- Concentrator 2:
 - Overland conveyor system to transport ore from the main coarse ore stockpile.
 - 2 x Crusher made by Metso.

Newcrest - Independent Technical Specialist's Report

Grant Samuel & Associates Pty Ltd

0223041

- SAG Mill made by Metso (Svedala) with conventional pinion drive, 32 foot diameter.
- Ball mill made by Metso, 6.7 m diameter x 8.5 m.
- Vertimills installed in tertiary grinding capacity.
- Flash flotation cell.
- One Jameson cell operating in a rougher duty.
- One bank of conventional rougher and scavenger cells with and a combination of Outotec conventional cleaner, cleaner-scavenger and recleaner cells float cells, complementing Jameson final cleaner cells.
- 2 x Vertimills made by Metso (0.93 MW) in regrinding duties.
- Tailings thickeners made by Outokumpu Superflo 29 m diameter.
- Concentrate thickener made by Outokumpu Superflo 20 m diameter.

2.6.2 Metal recovery

Newcrest reports that gold recovery over FY23 has averaged around 78% and copper recovery around 84%. There is additional revenue with silver recovered from final products. Molybdenum has been a source of revenue since April 2022.

The Newcrest LOMP forecasts:

- copper recovery of 85% to 90% with an average of 88%.
- gold recovery of 78% to 83% with an average of 81%.
- silver recovery of 63% to 68% with an average of 65%.
- molybdenum recovery of 67% to 76% with an average of 72%.

These recovery forecasts are related to head grades.

Fluorine is the major deleterious element, however since 2017 its rejection has been maximised in flotation through the use of Jameson cells (installed in 2013, 2016, and 2017) and has consistently reduced fluorine in the concentrate to well below specified contractual limits.

2.6.3 Concentrate transport and marketing

The combined concentrate from the two concentrators is pumped to the Molybdenum Plant for molybdenum recovery before being thickened and pumped to Blayney, where it is filtered and railed to Port Kembla for export.

The copper concentrate produced is considered high-quality and contains high-grade gold and payable silver credits with an overall low level of impurities. Several buyers exist under current contracts, primarily in Asia. A portion of the free gold recovered in the gravity concentrator is smelted on-site to produce gold doré.

The molybdenum product is bagged at the Molybdenum Plant in preparation for transport.

2.6.4 Tailings storage

The site has three tailings storage facilities located within three lease boundaries, named Northern TSF (NTSF), Southern TSF (STSF), and the mined-out Cadia Hill open pit TSF (PTSF). A significant number of successful embankment raises have been undertaken over the past twenty years, virtually all of which have been upstream construction.

Currently, the PTSF is solely used for storage as the NTSF has structural instability and dam integrity concerns which are being assessed. The STSF is also undergoing new work and is not used at present. Another tailings facility, STSFX with much smaller footprint is the subject of a feasibility study with the objective of assisting with overall storage requirements. The current

Newcrest - Independent Technical Specialist's Report

Grant Samuel & Associates Pty Ltd

0223041

plan regarding tailings storage indicates there will be sufficient volume available to accommodate tailings (at the increased rates) to beyond 2050.

Recent assessments have indicated that the current STSF capacity will be exhausted by 2031 and that NTSF will be exhausted by 2030. Current studies are investigating options and have indicated that Cadia will require a further approximately 600Mt of storage (beyond existing facilities) to allow for continued operations until approximately 2050. Trade-off studies continue to consider options regarding future production output, capital required to achieve the wall lifts and the re-use of tailings as a construction material, environmental impact and community considerations, whilst achieving maximum value for Cadia without commitment of funds until later in the asset life.

The coarsening of the primary grind size has resulted in a decrease for thickener dewatering time due to the reduction in slime particles (<38 micron) produced, thus enabling an increase in disposal of tailings to the TSF dams and, in turn, an increase in processing throughput to be achieved.

A significant event occurred in 2018 when the Northern TSF lost containment of tailings, however these were captured by the basin of the Southern TSF. An independent review board investigated this event and it recommended enhancing the type of monitoring as well as the equipment being used across the tailings storage facilities with a more precautionary view in future design and construction.

2.6.5 Future ore processing plans

In the case of Cadia East ore, five copper recovery models have been developed for the purposes of forecasting based on copper head grades. Experiences have shown that these models provide a very good estimation of future production.

Metallurgical variability has been studied and identified that Cadia East and Ridgeway are 'well-behaved' porphyry copper deposits, in which processing is well understood and risks can be controlled using established industry standard risk mitigating actions.

The increased throughput predicted for FY24 should be achieved by a coarsening of the primary grind size. This coupled with increased flotation capacity and installation of processing units that specifically target coarse copper particles should enable Newcrest to meet these processing targets.

2.7 Site infrastructure and services

2.7.1 Power supply

Power is supplied by the state-owned electricity firm via a dedicated transmission line with a transfer capacity of 284 MVA. Site power consumption is split approximately 40 MW used for underground mining and 110 MW for processing. Concentrator 1 uses approximately 60% of the total site power consumption whereas Concentrator 2 used around 15%.

With the proposed increase in throughput to 35Mtpa, modelling and negotiations have continued with the electricity supplier and the demand is expected to be met.

2.7.2 Water supply

The water requirements are proportional to the amount of mineral processing occurring and therefore as throughput increases so too will the daily water requirements. The water supply system has been designed to recycle as much of the on-site water as possible, with make-up water from local sources as required. Agreements are in place with the City of Orange and the annualised license agreement with Newcrest is reviewed annually. The Newcrest LOMP assumes that between 65% to 70% of water used is recycled, however Cadia continue to work on further water saving initiatives. To address the additional water required for an expansion to 35Mtpa, in

Newcrest - Independent Technical Specialist's Report

Grant Samuel & Associates Pty Ltd

0223041

the context of a history of periodic drought, Cadia has included a new South Water Storage Dam in the EIS. In addition, Cadia is pursuing various other projects to secure future water supplies.

2.7.3 Other infrastructure

All roads and infrastructure to support the mine access, and Concentrator 1, Concentrator 2, the Molybdenum Plant, and construction of the future TSF for the LOM are in place. There is no accommodation on-site as it is a drive-in/drive-out mine site.

The Cadia East PC1-2 FS has considered the changing site requirements as the subsidence zones expands as the mining footprint increases. The reasons being that as the back of each cave approaches the surface, the ground will no longer support itself and subsides into the cave. A number of areas have been identified including offices, workshops, bunkers as well as overhead powerlines as requiring modification and/or relocation due to this change in future mining.

2.8 Environmental, Social, and Permitting

2.8.1 Environmental and regulatory approvals background

Cadia operations are conducted across six MLs 100% owned by Newcrest through subsidiaries:

- MLs - ML1405, ML1449, ML1472, ML1481, ML1689, and ML1690
- ELs - EL1024(P), EL3856, EL4616, EL4620, and EL5609
- Two leased premises - the Blayney Dewatering Facility and the Orange Laboratory
- Three bio-diversity offset areas

Additionally various easements are in place for pipelines (concentrate, dewatering, effluent), powerline corridors and infrastructure located on land owned by NSW Forests and subject to occupation permits. The Cadia tenures covers total area of approximately 215 km².

2.8.2 Current Primary Approvals

Project Approval (PA 06_0295) for Cadia East was under the NSW *Environmental Planning and Assessment Act* 1979 in January 2010 and Commonwealth approval by the now Department of Climate Change, Energy, the Environment and Water (DCCEEW) on 18 February 2010. A Commonwealth agreement in January 2010 combined all federal and state requirements into a single State-managed approval process.

PA 06_0295 includes all components of the Cadia Operations including Cadia East underground mine, Cadia Hill open pit mine, Ridgeway underground mine, Blayney dewatering facilities (potentially Cadia Dewatering Facility), and other ancillary and supporting infrastructure.

Table 2.6 outlines the key approvals listed by Newcrest for Cadia operations, and AMC notes the existence of secondary approvals (for example, abstraction of groundwater, surface water, heritage etc) obtained under the Environmental Assessment and Federal approvals process, however not all these have been sighted as part of this review.

Annexure 1. Independent Expert's Report

Newcrest - Independent Technical Specialist's Report

Grant Samuel & Associates Pty Ltd

0223041

Table 2.6 Primary Approvals

Regulatory Authority	Details of Approval	Expiry Date
D CCEEW (Commonwealth)	EPBC Approval 2006/3196 - Plan to offset loss of 23ha of the White Box-Yellow Box-Blakely's Red Gum grassy woodland and derived native grassland ecological community.	20 June 2031
NSW Dept Planning, Industry & Environment	Cadia East Project Approval PA 06_0295 (Modification 14 approved December 2021)	30 June 2031
Dept Environment & Climate Change ⁴	Environment Protection Licence – 5590 revisions and Variations – 1044527, 1062939, 1072425, 1079491, 1501850, 1512341, 1515014, 1535598, 1547719, 1562794, 1568059, 1587314, 1595668, 1609965, 1612911	Various

The approved PA 06_0295 contains information on the Cadia operations and the management requirements for waste rock and stockpiles, water supply, tailings disposal and general environmental and social aspects. AMC notes the following relating to the Project Approval and other relevant approvals:

Waste Rock Management

Cadia underground mining operations produce minimal waste rock material, with the majority of the waste rock placed in the mine North and South waste rock dump (WRD) with a small amount in Cadia Extended WRD. The waste rock materials are classified via a colour code system according to source and content - benign waste rock (non-acid forming,) is used for construction, low-grade ore and mineralised waste are used for reclamation and are placed in accessible parts of the South WRD.

Potentially acid forming (PAF) waste is encapsulated with a combination of a low-permeability layer and a cover of benign non-acid forming (NAF) waste material over each layer of PAF waste material. This cover system is designed to reduce oxygenation and infiltration rates.

Tailings Storage Facilities

Three TSFs exist within the Cadia Mining Leases - the NTSF, the STSF and the PTSF). In March 2018, a slump event occurred in the southern wall of the NTSF causing a loss of containment which was captured in the STSF. An Independent Technical Review of the incident was undertaken and released to the public in April 2019, and subsequently approval was granted to use the former Cadia Hill open pit as a TSF.

In 2020, tailings disposal to the NTSF and STSF ceased, and consultation commenced with regulators to convert them to centreline raised dams. AMC has been unable to verify if this work has been completed and notes that an Independent Technical Review Board was established for Cadia in 2022 to oversee Cadia TSF facilities.

AMC notes NTSF and STSF have been subject to NSW Environment Protection Authority (NSW EPA) scrutiny following the issue of a 'show cause' notice in April 2022 relating to a TSF dust event and the issue of a penalty notice in August 2022 for failing to maintain appropriate levels of dust mitigation on the NTSF and STSF. The TSFs have also been subject to complaints from local residents regarding dust lift events.

AMC further notes the use of aerial dispersion of suppressants, hydromulching, and application of dust suppressants to the TSF surfaces and notes that Cadia is working with regulators and the community to resolve issues. The actions are current and ongoing.

⁴ Now NSW Office of Environment & Heritage.

Newcrest - Independent Technical Specialist's Report

Grant Samuel & Associates Pty Ltd

0223041

Water supply and management

Water is sourced from several locations dependent on agreement conditions, licensing, and the amount of water available for Cadia. Water use is monitored for compliance reporting and efficiency improvement and a Water Management Plan is in place.

Most water on-site is recycled from the TSF and return water from Blayney Dewatering Facility. Make-up water is extracted from the Belubula River, Cadiangullong Dam, Flyers Creek Weir, Cadia Creek Weir, Orange, and Blayney Sewage Treatment Plant treated effluent, on-site groundwater extraction bores, and site runoff.

The Annual Environmental Management Report summarises the yearly water management activities. Droughts have resulted in critically low water levels from some sources and limited water harvesting opportunities from licenced areas. AMC notes that the supply sources have variable levels of risk due to climatic influences and storage capacity and the Cadia life-of-mine plan assumes that 65% to 70% of water is recycled.

Biodiversity offsets

Cadia is located within a temperate Eucalyptus Forests Biodiversity Hotspot which encompasses subtropical rainforest, subtropical dry rainforest, warm temperate rainforest and cool temperate rainforest. This hotspot is known for its variety of vegetation communities and diverse geological conditions.

Baseline assessments identified 554 species of flora and fauna that could potentially occur within or near Cadia. Of these species, three are considered Critically Endangered, four are Endangered, six are Vulnerable, five are considered Data Deficient and 15 considered Near Threatened.

The Cadia Biodiversity Offset Strategy was designed to mitigate the potential impacts associated with clearing approximately 238 ha of native vegetation for Cadia (including 23.5 ha of a NSW-listed Box-Gum Woodland Endangered Ecological Community; of which 23 ha was the Commonwealth listed Box-Gum Grass Woodland and Derived Native Grasslands Critically Endangered Ecological Community). The Strategy integrates rehabilitation activities with regional conservation initiatives.

AMC notes that under this Strategy, Cadia has three biodiversity offset areas - the Black Rock Range, Flyers Creek, and Stratton Vale. The majority of the biodiversity offset area is located on Black Rock Range which is 11 km west of the Cadia Operations and contains 653 ha of remnant vegetation and approximately 173 ha of mainly cleared agricultural land which is to be fenced and revegetated. Another 112 ha of offset area is located at the junction of the Belubula River and Flyers Creek.

Compliance and regulatory reporting

An annual summary of the Cadia's sites environmental performance is provided through the Annual Environmental Management Report in accordance with the requirements of the Cadia East Project Approval and the NSW Department of Planning and Environment Annual Review Guidelines.

Reporting addresses aspects such as noise, air quality, meteorological, flora and fauna, erosion and sediment control, visual, blast and vibration, groundwater level quality, spring, surface water flows, aquatic ecosystems, rehabilitation and pollution discharge monitoring.

As a requirement of Project Approval and NSW Environmental Protection Licence 5590, all pollution monitoring data is published on Newcrest's website. Depending on key areas requirements, reporting may also comprise monthly reports, quarterly reports, year reports and summaries.

Annexure 1. Independent Expert's Report

Newcrest - Independent Technical Specialist's Report

Grant Samuel & Associates Pty Ltd

0223041

Environmental monitoring

The approvals in place provide operational environmental performance indicators and thresholds for Cadia. Environmental monitoring at Cadia is undertaken in accordance with the Cadia East Project Approval, NSW EPA Environmental Protection Licence 5590 and the Cadia East Environmental Assessment Commitments.

Monitoring is undertaken by external independent consultants and internal technical experts. AMC notes that established Management Plans and monitoring programmes are in place that outline the method, frequency and reporting requirements.

In accordance with the Cadia East Project Approval, independent audits conducted by external consultants are also required to be undertaken, mainly for air quality, dust and TSF related matters.

It was also noted that an Air Quality and Greenhouse Gas Management Plan for Cadia was still in a draft format and is thorough in addressing each component of the requirements.

Non-compliances

Cadia has experienced a number of environmental incidents, including those occurring at the TSFs described above. Additional infringements issued for Cadia available on the NSW EPA website are listed in Table 2.7.

Table 2.7 NSW EPA Penalty Notices in the last 10 years

Penalty Notice/Offence Short Title	Offence Date	Penalty Notice Issued Date
3050087242 - Pollute Waters - Corporation	25 October 2012	26 February 2013
3050087251 - Contravene of Part 5 pt 7 of the Protection of the Environment Operations Act 1997 - Corporation	26 February 2013	26 February 2013
3085769262 - Supply false or misleading certificate - Corporation	7 November 2012	26 February 2013
3173529270 - Contravene condition of licence - Corporation	5 March 2020	31 July 2020
3173530957 - Contravene condition of licence - Corporation	13 August 2021	4 March 2022
3173540141 - Contravene condition of licence - Corporation	19 April 2022	5 August 2022

AMC further notes that on the 22 May 2023, a NSW EPA media release advised that Cadia has been issued with a draft pollution Prevention Notice and a draft licence variation on the 19 May 2023 regarding the management of emissions of dust and other pollutants as part of a new investigation commenced by the NSW EPA.

A full health risk analysis has also been requested by the NSW EPA from the NSW Chief Health Officer. This investigation is in parallel to a separate investigation from 2022 relating to air quality concerns. Cadia was required to respond to the investigation by 23 May 2023. On 21 June 2023 the EPA requested Cadia take immediate action to reduce dust emissions from the mine's main vent rise.

2.8.3 Future approvals

Although there have been 14 modifications to the original Project Approval (with a further modification (MOD15) currently planned) - and detailed baseline studies (social, cultural heritage and environmental) have been completed for each modification; AMC notes that any further proposed expansions to Cadia will require updated baseline studies for these aspects.

Newcrest - Independent Technical Specialist's Report

Grant Samuel & Associates Pty Ltd

0223041

New authorisations are required for any development not covered by existing approvals and the Mining Operation Plans. AMC notes the Modification 15 application is being prepared by Cadia for:

- Changes to the embankment footprint of the STSF.
- Option to recommence Ridgeway Underground Mine.
- Realignment of Panuara Road, construction of new access road, new emergency access road, trial tailings pilot plant and sand embankment (hydrocyclone sands).
- Additional ventilation shafts with fans on surface.
- Construction and operation of a 132 kV electrical switch yard.
- Request for approval to conduct TSF construction works in the evening period (6pm – 10pm) that complies with the Project Approval Noise Criteria.

2.8.4 Cultural Heritage

AMC notes that no Indigenous Land Use Agreement or Cultural Heritage Agreements with traditional landowners (the Wiradjuri People) exist and there are no sacred sites on Cadia-owned land. Several archaeological studies have been undertaken in the Cadia Valley area and 21 Aboriginal Heritage Sites have been identified that have not been previously disturbed.

In consultation with the Orange Local Aboriginal Land Council, a management plan focused on Aboriginal cultural heritage has been developed - the Aboriginal Cultural Heritage Management Plan. This Aboriginal Cultural Heritage Management Plan outlines the management and monitoring of Aboriginal heritage at Cadia for the approved project period under Project Approval (PA 06_0295).

Consultation with Heritage NSW and Orange Local Aboriginal Land Council is undertaken by Cadia for matters relating to the management of cultural heritage as described in the Cadia East Project Environmental Assessment. AMC notes at the time, the Orange Local Aboriginal Land Council was the only Aboriginal organisation to register as an Aboriginal stakeholder for the Cadia East Project. However, AMC notes that more recent advertising inviting Aboriginal people or groups who hold cultural knowledge relevant to determining the significance of Aboriginal objects and /or places within the Cadia Continued Operations Project to register an interest in participating in future consultations. This has resulted in the addition of six individuals; 10 Aboriginal Corporations / Nations / Associations; three Aboriginal heritage associations; one working party; and one descendants' organisation.

AMC notes that a major review of the Aboriginal Cultural Heritage Management Plan was to be completed by the end of 2023.

European Heritage

European heritage assessments have been conducted at Cadia, including assessments conducted as part of the Cadia Hill and Ridgeway Project Environmental Impact Statements (EISs) and the Cadia East Project Environmental Assessment. Cadia contains numerous sites, locations, structures and relics that are of European heritage significance, mostly comprising historical heritage from post-European settlement and mining in the Cadia area.

AMC notes that management measures are in place to address and mitigate impacts to European heritage areas in the Little Cadia and Wire Gully Gold Workings. These impacts were from previous mining activity at Cadia, progressive expansion of the NTSF and STSF, and potential blasting and seismic related impacts on the Cadia Engine House and Chimney.

2.8.5 Rehabilitation and closure planning

AMC notes that as of 30 June 2023, Newcrest holds a total of A\$203M in performance bonds for the rehabilitation of Cadia.

Newcrest - Independent Technical Specialist's Report

Grant Samuel & Associates Pty Ltd

0223041

Closure Plan

Under the *Mining Act* 1992 and other applicable legal requirements, a Mine Closure Plan (MCP) detailing the rehabilitation work for all mine landforms has been developed for Cadia, along with a Rehabilitation Strategy outlining the rehabilitation goals, final land uses and mine closure benchmarks. These documents are linked to the Land and Biodiversity Management Plan and the Mine Operations Plan, a requirement of mining leases, that contains Cadia's rehabilitation commitments for the period of the plan which is usually three years. The Mine Closure Plan is applicable to all Newcrest owned and leased land associated with Cadia Operations.

Waste rock areas have been progressively rehabilitated in line with approvals granted and MCP and Rehabilitation Strategy with varying success. Notable erosion was observed at both WRDs; and both the WRD and TSFs have been subject to a Section 240 notices issued by the Resources Regulator for non-performance.

In 2022, a third-party contractor commenced rehabilitation amelioration activities on a Cadia WRD in consultation with regulators, and this is scheduled for completion in 2023.

The MCP was scheduled for revision in 2020/21 and was to include cost assessments, options analysis, updated TSF assumptions and costs due to possible changes in response to the 2018 TSF incident among other revisions.

Closure Cost Estimates

Cost provisioning for closure during the life-of-mine operations is required to ensure that adequate funds are available at the time of closure to meet Newcrest's commitments and that the community is not left with an unacceptable liability.

Closure cost estimates have been determined using methods outlined in the Newcrest Mine Closure Standard and Newcrest Global Accounting Policy. Unit rates and costs within the MCP are based on actual rehabilitation costs, an independent review, and an independent 2010 mine closure and provisioning review.

The highest estimates from these studies were used as the closure cost estimate. Cost estimates are outlined in spreadsheets separate to the Mine Closure Plan with estimates reviewed every three years until a ten-year period to planned mine closure. AMC only had access to review the final 2019 cost estimates which describe the total closure cost for Cadia at A\$219M. AMC is aware that the mine closure plan is being updated for June 2023.

2.8.6 Conclusions

While Cadia appears to have ongoing impacts to both the environment and social aspects, these are generally in keeping with the scale and nature of the project, but these are not linked to reported non-compliances. Cadia has an existing comprehensive management framework which is subject to NSW State and Federal Government approval conditions which are appropriate for managing key issues and impacts.

However, matters for further consideration are the adequacy and reliability of the most recent MCP and its associated closure costs estimate (being updated), and the current investigations being carried out by the NSW EPA and the concerns being raised by the community. Current data is available on the Cadia and NSW EPA websites.

Newcrest - Independent Technical Specialist's Report

Grant Samuel & Associates Pty Ltd

0223041

2.9 Costs

2.9.1 Operating costs

Historical unit operating costs for mining, processing, and general and administration (G&A) are shown in Table 2.8.

Table 2.8 Cadia historical unit operating costs

Activity	Units	FY21	FY22	FY23
Mining & Engineering	A\$/t ore mined	5.91	7.58	7.90
Processing	A\$/t ore milled	9.46	11.21	11.65
G&A	A\$/t ore milled	3.69	4.55	5.41

The FY23 ore mined at Cadia was 29.06Mt against a budget of 32.35Mt, a deficit of 10%. Underground mining costs were A\$192.6M, 6% below the budget value of A\$205.6M. Engineering costs were above budget at A\$25.7M versus a budget of A\$23.4M. The combined unit mining and engineering costs are within five percent of the budget estimate at A\$7.90/t ore mined.

FY23 mill throughput was 29.08Mt, 16% below the budget of 34.49Mt. Treatment costs for the period were A\$338.9M, were 2% below the budget of A\$346.3M. The unit treatment cost was A\$11.65/t ore milled compared to the budget of A\$10.04/t ore milled.

2.9.2 Capital expenditure

Newcrest provided AMC with a capital expenditure profile with the LOM production and cost schedule. AMC has reviewed these capital expenditure estimates and believes they are generally reasonable. AMC has adjusted capital expenditure estimates where it was considered necessary for the AMC production cases, discussed in section 2.10.

2.10 AMC production cases

Newcrest provided AMC with a LOM production and cost schedule (Newcrest LOMP) for Cadia together with supporting information. The schedules are presented on an annual basis.

Based on the information provided by Newcrest, discussions with Newcrest personnel, and observations made during AMC's site visit, AMC developed two production cases:

- AMC Production Case 1 is based on the Newcrest LOMP physicals and reflects AMC's adjustments to the mining and treatment costs and an adjustment to the LOM metallurgical recovery estimates.
- AMC Production Case 2 represents the Newcrest LOMP which AMC considers is the upper reasonable limit of the potential for the Cadia operations LOM to FY50.
- During preparation of this ITSr, the issue of excess dust generation from the Cadia surface exhaust fans was raised as a concern for regulators and the community. Newcrest has identified actions to address these concerns and commissioned a project to resolve the issue. Newcrest has advised that the solution has an eventual cost of A\$36M to install permanent dust collectors by May 2025. In the interim, a temporary solution will be installed by September 2023. The interim solution to the dust issue will have a partial impact on underground production. During this time, mill feed will be supplemented by stockpiled material at similar grades. AMC has reviewed this matter and the solution presented by Newcrest and consider the impact to be negligible to the value of the AMC production cases presented below. The cost of A\$36M is included in the AMC production cases as capital expenditure of A\$18M in FY24 and A\$18M in FY25.

Annexure 1. Independent Expert's Report

Newcrest - Independent Technical Specialist's Report

Grant Samuel & Associates Pty Ltd

0223041

2.10.1 AMC Production Case 1

AMC Production Case 1 is based on the Newcrest LOMP physicals and costs and consideration of the stated Ore Reserves. AMC has made the following key adjustments which are based on reasonable grounds:

- The Mining and Engineering operating cost has been adjusted upwards from the Newcrest LOMP. The adjusted costs reflect a combination of alternative operating cost estimates from the PC2-3 Feasibility Study, recent actual values, AMC estimates, and Cadia production planning.

The Treatment operating cost has been adjusted upwards by approximately 10% from the Newcrest LOMP to reflect AMC's opinion on the long-term average treatment cost across all saleable products.

Relative to the Newcrest LOMP, AMC adjusted the average processing recovery for all production streams down by an average of one percent for the LOM as a representation of multi-factor potential risks including variability in mineralisation, grade, and rate of throughput.

A summary of the AMC Production Case 1 is shown in Table 2.9 and Table 2.10.

Table 2.9 AMC Production Case 1 – Cadia production schedule

Estimate	Units	FY24	FY25	FY26	FY27	FY28	FY29 to FY38	FY39 to FY50	Total
Underground ore mined	Mt	34.0	32.5	33.4	33.6	33.4	346.4	362.6	876
Copper grade	%	0.32	0.30	0.32	0.32	0.34	0.29	0.32	0.31
Gold grade	g/t	0.46	0.37	0.37	0.39	0.42	0.48	0.45	0.46
Ore milled	Mt	35.0	35.0	36.3	34.7	33.8	349.6	370.1	895
Copper feed grade	%	0.32	0.30	0.32	0.32	0.34	0.29	0.32	0.31
Gold feed grade	g/t	0.46	0.37	0.37	0.39	0.42	0.48	0.45	0.46
Copper recovery	%	84.3	84.7	85.3	86.6	87.6	87.7	86.6	87
Gold recovery	%	78.6	77.5	77.8	78.8	79.5	81.0	79.8	80
Concentrate produced	kt	374	349	392	387	406	3,774	4,200	9,882
Copper in concentrate	kt	95	88	99	97	101	890	1,035	2,405
Gold in concentrate	koz	337	261	278	277	298	3,567	3,601	8,620
Gold in doré	koz	74	59	62	61	66	771	795	1,887

Notes:

- The values in the table are subject to rounding.
- Concentrate produced is in dry metric tonnes.

Table 2.10 AMC Production Case 1 – Cadia cost schedule

Cost Estimate	Units	FY24	FY25	FY26	FY27	FY28	FY29 to FY38	FY39 to FY50	Total
Operating Costs									
Mining	A\$/t mined	6.25	6.25	6.25	6.25	6.25	6.35	7.35	6.75
Treatment	A\$/t milled	10.60	10.46	8.97	8.53	8.64	9.35	10.62	9.67
G&A	A\$M	130	121	120	120	118	1,178	1,064	2,852
Capital Expenditure									
Growth capital	A\$M	330	326	298	466	388	1,986	756	4,550
Sustaining capital	A\$M	347	187	130	128	87	728	772	2,378
Rehabilitation*	A\$M	-	-	-	-	-	-	322	322

Note: Rehabilitation expenditure extends to FY52.

Newcrest - Independent Technical Specialist's Report

Grant Samuel & Associates Pty Ltd

0223041

2.10.2 AMC Production Case 2

AMC Production Case 2 is aligned with the Newcrest LOMP in physicals and costs for the Cadia LOM. AMC considers this case to be the upper reasonable limit of the potential for the Cadia operations LOM to FY50. AMC Production Case 2 is summarised in Table 2.11 and Table 2.12.

Table 2.11 AMC Production Case 2 – Cadia production schedule

Estimate	Units	FY24	FY25	FY26	FY27	FY28	FY29 to FY38	FY39 to FY50	Total
Underground ore mined	Mt	35	34	35	35	34	350	370	893
Copper grade	%	0.33	0.30	0.32	0.32	0.34	0.29	0.32	0.31
Gold grade	g/t	0.48	0.37	0.39	0.39	0.42	0.48	0.45	0.46
Ore milled	Mt	35	35	36	35	34	350	370	895
Copper feed grade	%	0.33	0.30	0.32	0.32	0.34	0.29	0.32	0.31
Gold feed grade	g/t	0.46	0.37	0.39	0.39	0.42	0.48	0.45	0.46
Copper recovery	%	85.2	85.6	86.2	87.5	88.4	88.6	87.4	87.8
Gold recovery	%	79.4	78.3	78.6	79.6	80.3	81.75	80.58	80.9
Concentrate produced	kt	386	350	391	389	408	3,798	4,215	9,936
Copper in concentrate	kt	98	89	99	98	101	895	1,038	2,418
Gold in concentrate	koz	355	266	290	282	302	3,590	3,630	8,715
Gold in doré	koz	77	59	64	61	66	766	791	1,885

Notes:

- The values in the table are subject to rounding.
- Concentrate produced is in dry metric tonnes.

Table 2.12 AMC Production Case 2 – Cadia cost schedule

Cost estimate	Units	FY24	FY25	FY26	FY27	FY28	FY29 to FY38	FY39 to FY50	Total
Operating Costs									
Mining	A\$/t mined	6.15	6.04	5.99	5.54	5.69	6.00	5.95	5.96
Treatment	A\$/t milled	9.64	9.51	8.15	7.76	7.86	8.50	9.66	8.79
G&A	A\$M	130	121	120	120	118	1,178	1,064	2,852
Capital Expenditure									
Growth capital	A\$M	330	326	298	466	388	1,986	756	4,550
Sustaining capital	A\$M	347	187	130	128	87	728	772	2,378
Rehabilitation*	A\$M	-	-	-	-	-	-	-	322

Note: Rehabilitation expenditure extends to FY52.

2.11 Key risks and opportunities

2.11.1 Risks

In preparing the ITSR, AMC identified the following material risks:

- Water security – Prolonged drought periods have been identified as are a risk to future operations.
- TSF Management – Cadia has and is experiencing issues associated with management of the TSF wall slumps and dust releases.
- Increase in processing rates exceeding 35 Mt per calendar year will require a revised water balance, additional water supplies and or storages.
- The Taskforce on Climate-related Financial Disclosures and Climate Financial Driver Analysis identified under RCP4.5 and RCP8.5 scenarios water scarcity, flood, extreme heat, heat stress, wildfire, and wind as physical risk areas for the Cadia operating site.

Newcrest - Independent Technical Specialist's Report

Grant Samuel & Associates Pty Ltd

0223041

- Community concerns and NSW EPA investigations regarding quality of air and contamination of water used for potable water has gained media attention. If not addressed to EPA satisfaction, regulators may take actions that impact on Cadia operations.
- Induced seismicity from caving activities – Mitigating actions by the operator include seismic monitoring, blast exclusion zones, hydrofracturing, increasing pillar sizes, and automation.
- Ingress of dilution from adjacent cave – Mitigating actions by the operator include material flow modelling and strict draw control practices.
- Metallurgical recovery during the supplementary processing of ore stockpiles while temporary dust collectors are being installed in the underground exhaust ventilation system – It is likely that ore on stockpile is partially oxidised, potentially resulting in some adverse impact on metal recoveries in the processing plant during the period when such processing of stockpiles is scheduled. After that period, processing of stockpiles will be discontinued. Therefore, any reduction in metal recoveries because of this processing of stockpiles would be in the immediate-term only and not have a material impact on production.

2.11.2 Opportunities

In preparing the ITSR, AMC identified the following opportunities that may provide benefits into the future:

- Automation is employed at PC1-1 in response to mining conditions. The opportunity this provides is maintaining a safe working environment where hazardous conditions are experienced whilst being productive.
- Single pass cave establishment is a method of cave development where only the extraction level is required to both create draw bells and the cave undercut. The opportunity being cost saving by not developing the undercut. Evaluation by Newcrest proposes that this methodology could save approximately 20% cost and 10% time compared to post-undercut block caving.
- Ground support optimization is a focus for future cave fronts at Cadia East Underground, whereby ground support design can be employed based on modelling and engineering demands. Additionally, installation of dynamic components can be phased based on the circumstances identified underground. Either within the first pass development cycle or campaigned basis on a second basis.

Newcrest - Independent Technical Specialist's Report

Grant Samuel & Associates Pty Ltd

0223041

3 Telfer and Havieron

3.1 Location and background

3.1.1 Location

Telfer is a fly-in-fly-out gold mine located in the Great Sandy Desert in the Paterson Province of Western Australia, approximately 450 km east-south-east of Port Hedland and 680 km north-east of Newman. It is 1,310 km by air and 1,900 km by road from Perth and falls within the boundaries of the East Pilbara Shire, an area covering 386,000 km².

The Havieron gold project is located approximately 45 km east of Telfer. The project is currently approximately a 1.5-hour drive from Telfer via the Camp Dome access track.

The locations of Telfer, Havieron, and the Camp Dome, O'Callaghans, and other satellite deposits are as shown in Figure 3.1.

Figure 3.1 Telfer location

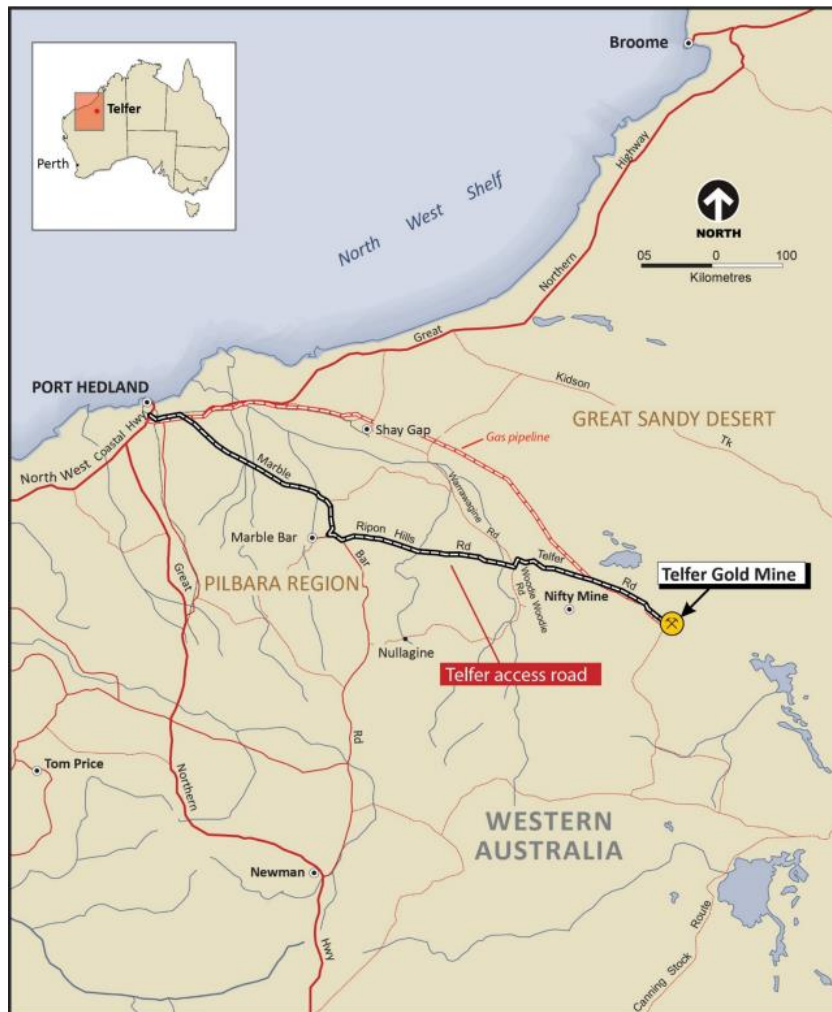

Annexure 1. Independent Expert's Report

Newcrest - Independent Technical Specialist's Report

Grant Samuel & Associates Pty Ltd

0223041

The Camp Dome deposit is located 20 km by road north of the Telfer mine site. Access to the project area is via the main Telfer–Port Hedland road then north-east along the existing Minyari track and sandy base line tracks.

The O'Callaghans polymetallic skarn deposit is located approximately 10 km south of Telfer.

3.1.2 Background

Telfer is comprised of the Main Dome and West Dome open pit and underground mines and produces gold and copper via a large, dual train, comminution circuit followed by flotation and cyanide circuits, which produce gold doré and a copper-gold concentrate. The concentrate is trucked to Port Hedland from where it is exported to various smelters.

It is publicly reported that:

- Telfer was discovered by Newmont in 1971.
- The mine was developed in 1975 as a joint venture between BHP and Newmont and opened in 1977.
- In 1990, a merger between BHP Gold and Newmont resulted in the creation of Newcrest, which owns Telfer.
- Mining was suspended in October 2000 with the gold price of less than US\$300/oz and a combination of escalating costs, and processing constraints arising from the increasing proportion of sulphide inventories (which could not be economically processed under the previous processing flowsheet due to the prevalence of cyanide-soluble copper) in the ore encountered at the base of the open pit. Newcrest then focused on exploration.
- A feasibility study to redevelop the mine was completed in 2002 based on a strategy to treat copper as a by-product credit.
- A new processing plant and power station were constructed over a two year period and the mining operation recommissioned in 2004 and officially reopened in July 2005 with deepened open pits (Main Dome and West Dome), an expanded underground mine beneath the Main Dome pit with ore transported to the surface via a 6 Mtpa shaft hoisting system, and a new gas supply line from Port Hedland.

3.1.3 Tenement holdings

The Telfer district tenure, including Havieron and O'Callaghans, comprises 13 Els, 53 MLs, 19 miscellaneous licences, and four general purpose leases. Material tenure for Telfer and Havieron (the Amended Proposal) are listed in Table 3.1.

Table 3.1 Telfer and Havieron -material land tenure and authorisations

Tenement Number	Area (ha)	Tenement Type	Tenement Expiry Date	Status
E45/2932	8,120	Exploration Licence	03-July-2024	Current
G45/1	200	General Purpose Lease	17-December-2024	Current
G45/2	200	General Purpose Lease	17-December-2024	Current
G45/3	200	General Purpose Lease	17-December-2024	Current
G45/4	100	General Purpose Lease	17-December-2024	Current
L45/3	100	Miscellaneous Licence	17-December-2024	Current
L45/68	4	Miscellaneous Licence	19-December-2026	Current
L45/69	12.2589	Miscellaneous Licence	19-December-2026	Current
L45/73	13.255	Miscellaneous Licence	23-July-2027	Current
L45/79	14.304	Miscellaneous Licence	18-August-2024	Current
L45/80	3.49	Miscellaneous Licence	18-August-2024	Current
L45/99	22.5	Miscellaneous Licence	22-August-2042	Current
L45/106	4.545	Miscellaneous Licence	14-June-2043	Current
L45/583	328.4	Miscellaneous Licence	15-August-2043	Current

Newcrest - Independent Technical Specialist's Report

Grant Samuel & Associates Pty Ltd

0223041

Tenement Number	Area (ha)	Tenement Type	Tenement Expiry Date	Status
L45/622	45.156	Miscellaneous Licence	13-July-2042	Current
L45/636	2,429.55	Miscellaneous Licence	13-February-2043	Current
M45/6	1,000	Mining Lease	17-December-2024	Current
M45/7	1,000	Mining Lease	17-December-2024	Current
M45/8	1,000	Mining Lease	17-December-2024	Current
M45/9	450.05	Mining Lease	17-December-2024	Current
M45/11	1,000	Mining Lease	17-December-2024	Current

3.1.4 Production performance

The production performance of Telfer over the past three years is summarised in Table 3.2.

Table 3.2 Telfer recent production performance

Year	Units	FY21	FY22	FY23
Open Pit				
Ore mined	Mt	23.3	21.6	13.3
Total material mined	Mt	45.3	35.9	37.3
Gold grade mined	g/t	0.68	0.60	0.65
Copper grade mined	%	0.07	0.06	0.08
Underground				
Ore mined	Mt	1.98	2.32	1.98
Gold grade mined	g/t	1.64	1.13	1.23
Copper grade mined	%	0.30	0.29	0.41
Processing				
Ore processed	Mt	17.9	20.4	18.7
Gold feed grade	g/t	0.89	0.73	0.67
Copper feed grade	%	0.11	0.09	0.12
Gold recovery	%	78.7	81.9	82.3
Copper recovery	%	69.4	73.9	72.2
Gold produced	koz	416	408	349
Copper produced	kt	13	14	17

Source: Various Newcrest monthly reports, public documents, and company advice

In FY21, open pit mining physicals were aligned to the budget. Underground ore mined was behind budget (53% of budget tonnes). Ore milled, process recovery and feed grades were aligned to budget. Newcrest reported lower underground production was due to trucking issues, lower development, and poor ground conditions.

In FY22, open pit mining physicals were aligned to the budget. Underground ore mined was behind budget (70% of budget tonnes). Ore tonnes processed and feed grades were slightly lower than budget. Gold production was 95% of budget and copper production was 93% of budget. Underground production was impacted by stope availability, geotechnical issues and Covid-19 impact on personnel levels.

In FY23, open pit ore mining, underground ore mining, gold and copper grade, and ore tonnes processed were below budget impacting metal production. Gold production was 91% of budget and copper production was 81% of budget. Newcrest reported that open pit dewatering issues in Stages 2 and 4 impacted production. In the underground mine, lower-than-planned development and dewatering issues impacted production tonnes.

Newcrest - Independent Technical Specialist's Report

Grant Samuel & Associates Pty Ltd

0223041

3.2 Site visit

During AMC's site visit to Telfer deposit site in June 2023, key aspects of the operation were inspected including the underground workings, the processing plant, the core handling and storage area, and the QA/QC procedures and protocols. Discussions were also held with senior members of the Telfer operating team as well as with the senior Resource Geologists.

3.3 Telfer geology and Mineral Resources

3.3.1 Geology

The Telfer deposit and the group of tenements lie within the north-eastern portion of the Yeneena Basin, which is an irregular shaped sedimentary basin that lies to the east of the Pilbara Craton, west of Canning Basin and north-east of the Savory Basin (Figure 3.2).

Figure 3.2 Telfer regional geological plan

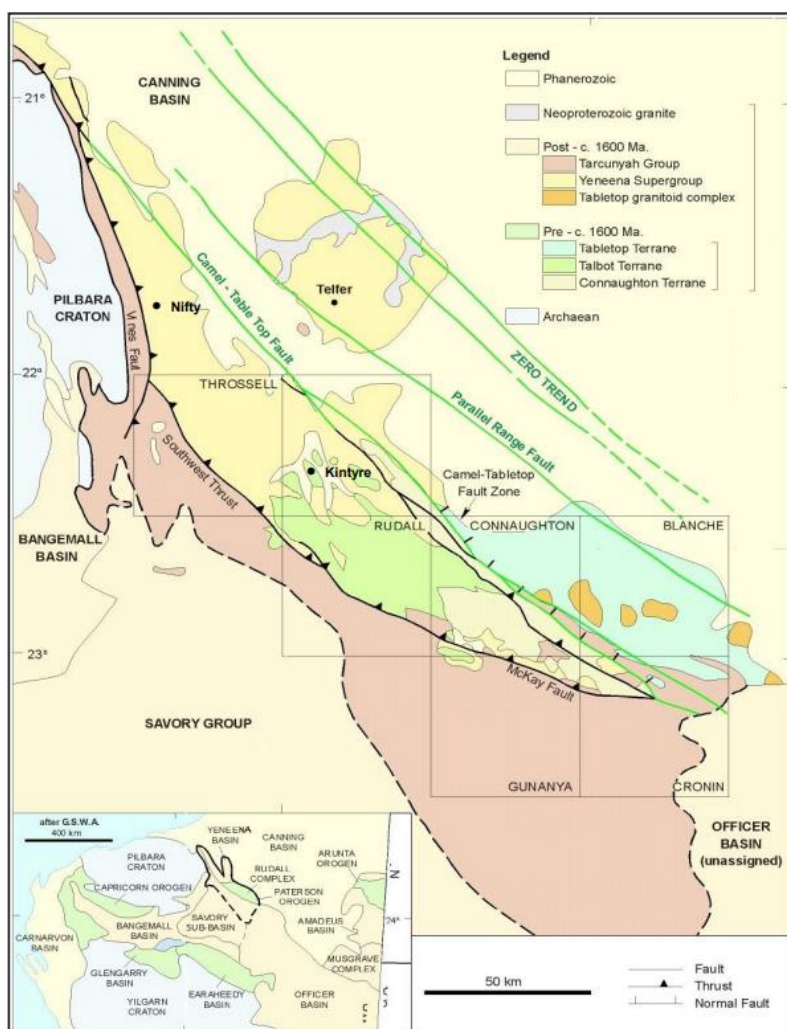

The Telfer gold-copper deposit is divided into the West Dome open pit operation and Main Dome underground operation including six upper M-Reefs, which form part of the Main Dome mineralization complex and consist of high-grade and narrow, bedding-concordant veins within the deposit.

Newcrest - Independent Technical Specialist's Report

Grant Samuel & Associates Pty Ltd

0223041

The geology of the Telfer deposit area consists of a late Proterozoic sequence of marine sediments that have been weakly metamorphosed, structurally deformed by folding and faulting and locally intruded by granites.

The Telfer Dome is composed of sedimentary units from the Telfer Formation and Malu Quartzite Member. Gold and copper mineralization are hosted within both formations. The Telfer Formation is subdivided into seven units that include mostly sandstones and siltstones. The Malu Quartzite Member is conformably overlain by the Telfer Formation and subdivided locally into five main stratigraphic units, mainly quartz sandstones and altered sandstones. Weathering locally modified mineralization to depths typically up to 200 m, with boundary between oxide and primary mineralization being irregular.

The topography at the Telfer mine site is dominated by two large scale asymmetric dome structures with steep west-dipping axial planes. Main Dome is located in the south-east portion of the mine and is exposed over a strike distance of 3 km north-south and 2 km east-west before plunging under the transported cover. West Dome forms the topographical high in the north-west quadrant of the mine and has similar dimensions to Main Dome.

The Havieron gold-copper deposit comprises a series of nested vertically extensive breccia columns cut up through and along the margins of an ovoid zone (700 m by 400 m) of pervasive hydrothermal alteration intruded by multiphase dykes (calc-silicate/calc-sodic). The breccia columns coalesce into a large volume of mineralization occurring along the contacts of the diorite dyke complex trending north-west to south-east and dipping south-west. Hydrothermal breccias are volumetrically most important where they coalesce to define the SE Crescent Zone. A north-north-east striking post-mineralization dolerite dyke traverses the deposit.

The Camp Dome project area is a complex domal structure comprising 17 Mile Hill Dome and its two subsidiary domes; Camp Dome and Pajero Dome. Camp Dome is within a doubly plunging anticline. It is a large north-west to south-east trending open fold with similar characteristics to Telfer Dome. The stratigraphy is interpreted to be Middle Malu Member to Lower Malu Member. Surface copper anomalism occurs at the crestal region of the dome and is interpreted to be equivalent of mineralization at Telfer.

The O'Callaghans polymetallic deposit lies at the contact between the Proterozoic Puntapunta Formation and the O'Callaghans granite. The Puntapunta Formation conformably underlies the Wilki Quartzite and overlies the Telfer Formation and is described as an outlier carbonate shelf deposit consisting of well-bedded clastic dolomite and limestone, with lesser amounts of calcareous sandstone and siltstone. The O'Callaghans granite has been identified at around 350 m below surface. Drilling has defined a zone of polymetallic skarn mineralization up to 60 m thick above the granite/limestone contact.

The Telfer Satellite deposits include Big Tree, Ironclad (or Backdoor West), and Dolphy gold prospects. The Big Tree deposit is located 25 km southeast of Telfer mine within the north-east flank region of Connaughtons Dome and is hosted by upper Malu Formation equivalent strata. Mineralization occurs within a host sandstone unit traceable over 900 m along strike. Structural interpretation suggests the plan view of mineralized envelope is sigmoidal along strike. The Backdoor deposit is located within the core region of Trotmans Dome and is hosted by steeply dipping Middle Malu Member stratigraphy. Exposure at Backdoor is dominant by two outcropping, notably limonitic quartz veined and "pocked", sericitized and silicified sandstone units. The Dolphy deposit occurs within the southwest flank of Trotmans Dome. It is hosted within Upper Malu Member strata, and mineralization at Dolphy is potentially hosted by an M-Reef equivalent unit.

Newcrest - Independent Technical Specialist's Report

Grant Samuel & Associates Pty Ltd

0223041

3.3.2 Mineral Resources

The Mineral Resources estimates reported by Newcrest for all deposits as at 30 June 2023 are listed in Table 3.3 for Gold and Copper Mineral Resources and Table 3.4 for Polymetallic Mineral Resources. The Mineral Resources estimates were prepared by Newcrest and are reported inclusive of Ore Reserves.

The Mineral Resources for Telfer open pits include surface stockpiles which were derived from both pits. The Main Dome Resources have been excluded from the statement due to the economics of extracting the remaining material and consequently have been removed from the Telfer Life of Province Plan. The Telfer Open Pit Mineral Resource is reported above a value-based cut-off using a revenue of US\$1,625 per ounce of gold, US\$3.60 per pound of copper and a 0.75 US\$:A\$ exchange rate. The value estimate includes metallurgical recoveries and associated processing and realization costs. The Open Pit Mineral Resource has been reported within a notional special constraining pit shell based on a revenue of US\$1,400 per ounce of gold, US\$4.00 per pound of copper and a 0.80 US\$:A\$ exchange rate.

The Mineral Resources for Telfer Underground include Vertical Stockwork Corridor (VSC), Sub Level Cave, Western Flanks, South West, Rey (previously Tassie), A-Reef, and M-Reef mineralization. Mineral Resources are reported above an NSR profit cut-off based on a proposed sub-level cave mining method for VSC and SLC, or open stope mining method for Western Flanks, South West, A-Reef and M-Reef, or paste fill stope mining method for the Rey. The Telfer Underground Mineral Resource is comprised of seven mining areas reported as an Indicated and Inferred in situ material.

The Havieron Mineral Resources comprise the Crescent Zone of sulphide and quartz-rich hydrothermal breccias and massive sulphide and a Calcite Cemented Breccia zone of massive calcite-cemented breccia. The Mineral Resource within the Crescent Zone has been reported with a notional constraining shell based on an A\$100/t NSR value cut-off, based on underground selective mining using sublevel open stoping. The mineralization within the Crescent Zone that is below the selective mining shell and Breccias is patchy, so a smoothed contiguous footprint of A\$50/t NSR has been used to constrain the classification and reporting based on potential bulk mining.

The Camp Dome Mineral Resource has been reported within a notional spatial constraining pit shell above 0.13% copper cut-off. The reporting cut-off is based on a cost structure for open pit mining and recovery of copper by acid leaching.

The O'Callaghans Mineral Resource comprises the main mineralized horizon where drillhole spacing is sufficient to permit Indicated or Inferred Mineral Resource classification. The Mineral Resource has an NSR cut-off used with a minimum mining height of 5 m applied. It is proposed the deposit is amenable to underground mining by open stope with paste backfill, and metallurgical recovery of the economic minerals can be achieved by gravity and flotation techniques.

As referred to above, the Telfer Satellite deposits are the three gold prospects: Ironclad (or Backdoor West), Big Tree, and Dolphy. The Mineral Resource assumes a conventional open-pit drill, blast, load and haul with dump leach constructed at site and CIL transported by road to the Telfer processing plant. The reporting cut-off grade is based on revenue of US\$1,300/oz gold, and no revenue is assumed for copper.

Newcrest - Independent Technical Specialist's Report

Grant Samuel & Associates Pty Ltd

0223041

Table 3.3 Telfer Gold and Copper Mineral Resources as at 30 June 2023

Deposit and Cut-off	Classification	Tonnes	Grade		Contained Metal	
		Mt (Dry)	Au (g/t)	Cu (%)	Au (Moz)	Cu (Mt)
Camp Dome (0.13% Cu)	Inferred	14	-	0.37	-	0.052
Havieron ² (Variable NSR A\$50/t-A\$100/t)	Indicated	28	3.2	0.51	2.9	0.14
	Inferred	57	1.4	0.14	2.6	0.082
Telfer Open Pits (NSR A\$22.50/t)	Indicated	39	0.75	0.053	0.93	0.020
	Inferred	1.6	0.85	0.044	0.045	0.00072
Telfer Stockpiles (NSR A\$22.50/t)	Measured	3.3	0.41	0.14	0.043	0.0046
	Indicated	6.9	0.37	0.054	0.082	0.0037
Telfer Underground ³ (Variable NSR A\$46.55/t-A\$147.96/t)	Indicated	29	1.9	0.44	1.8	0.13
	Inferred	14	1.5	0.40	0.70	0.056
Satellite Deposits (Oxide 0.20 g/t Au, transition and fresh 0.56 g/t Au)	Indicated	0.44	2.9	-	0.040	-
	Inferred	4.4	1.1	-	0.16	-
O'Callaghans ⁴ (NSR A\$80/t)	Indicated	63	-	0.30	-	0.19
	Inferred	6.5	-	0.26	-	0.017

Notes:

- ¹ All data reported is on a 100% asset basis.
- ² Newcrest attributable share 70%.
- ³ Updated Mineral Resources estimate informed by remodelling, interpretation, and classification based on infill and extensional drilling.
- ⁴ Reduction due to increase in NSR cut-off to align with internal Scoping Study outcomes.

Mineral Resources are reported under the provisions of the JORC Code.

The figures include those Mineral Resources converted to Ore Reserves.

Table 3.4 O'Callaghans Polymetallic Mineral Resources as at 30 June 2023

Deposit and Cut-off	Classification	Tonnes	Grade			Contained Metal		
		Mt (Dry)	WO ₃ (%)	Zn (%)	Pb (%)	WO ₃ (Mt)	Zn (Mt)	Pb (Mt)
O'Callaghans (NSR A\$80/t)	Indicated	63	0.36	0.56	0.28	0.23	0.36	0.18
	Inferred	6.5	0.29	0.23	0.14	0.019	0.015	0.0088

Notes:

- WO₃ Tungsten Trioxide.
- Reduction due to increase in NSR cut-off to align with internal Scoping Study outcomes.

Mineral Resources are reported under the provisions of the JORC Code.

WO₃ was calculated from estimated W using conversion factor of 1.2611.

3.3.3 Data collection

Telfer mine

An intensive exploration and resource drilling programme was undertaken at Telfer mine by Newmont from 1972 to 1975. Mining of oxide reef commenced in 1975. Large low-grade oxide Mineral Resource in Main Dome and to the north-west in West Dome was established and that resulted in a mill expansion in 1986 and established dump leach operation in 1986. Further exploration of the supergene and sulphide part of the Main Dome reef led to development of a sulphide flotation circuit in 1989. Exploration during 1990s developed additional reefs on the eastern flank of the Main Dome, which were mined using underground methods. Newmont Australia and BHP Gold merged to form Newcrest in 1990. Deep exploration drilling in 1991 led

Newcrest - Independent Technical Specialist's Report

Grant Samuel & Associates Pty Ltd

0223041

to discovery of additional reefs and associated stockwork mineralization. Drilling between 2000 and 2002 was aimed at identifying a large-tonnage low-grade copper-gold Mineral Resource that could be treated in a large-scale sulphide flotation circuit, which was started in 2005 and operates to date. A local plane grid covers the whole of the Telfer mine area, which was known as Telfer Mine Grid 2002, which was converted to Mine Grid of Australia 1994 Zone 51 in 2007.

AMC was presented with several databases for Telfer mine, which were separate for Telfer Open Pit and Telfer Underground models, as well as separate databases for different underground reefs. Various databases overlapped and some drillholes were used to generate different models. The drillhole database for open pits comprised 24,003 holes with the total combined length of 1,262 km. The database for the Main Dome had 2,415 holes (520 km of drilling) and 152 new holes (21 km of drilling). The presented database for the Upper Reefs included 13,429 holes (1,343 km of drilling) and several additional databases for underground fans and grade control.

The available drillhole data for the Mineral Resource estimate is largely based on drilling completed from 1998 to 2002, complemented with infill RC drilling. RC is the dominant drilling type at Telfer, contributing about 80% of the total metres drilled. The remainder of drilling is diamond holes, with mostly NQ diameter before 1998 and HQ diameter from 1993. Drillhole spacing is highly variable, but nominally spaced at 50 m by 50 m or 100 m by 100 m, infilled with RC holes at 50 m by 25 m, infilled with 10 m by 10 m immediately below pits.

Mine surveyors located all drill collars with DGPS on surface. Underground collars were located using a string line between fore and back points which were positioned using total station equipment.

All holes were geologically logged for lithology, alteration and mineralization. Diamond holes were also logged for veining and structure, and a minimum of 95% core recovery was reported.

Historically, RC drilling was to obtain 1 m or 2 m samples from which a 2 kg to 5 kg sub-sample was obtained using a riffle splitter. Drilling before 1998 ranges from 0.5m to 2 m sampled intervals with field duplicates collected at a frequency of 1 in 50 samples. More recent drilling used 2 m interval sampling with sub-sampling by stationary core splitter. Typical sample weight is 5 kg with 1:20 field duplicates.

Different analytical laboratories were used at various times of the project life. Typically, the analytical methods were a 50g fire assay for gold and, until September 2012, aqua regia or three-acid digest ICP determination for base metals. Since September 2012, multi-element ICP-OES/MS analysis followed a four-acid digest was the dominant method for base metals. Aqua regia is still used for base metals in grade control programmes.

Bulk density measurements were completed on 10 cm to 20 cm core samples using the weight in air-weight in water method. Total reported number of measurements was close to 30,000 for both Telfer open pits and underground resources.

Drilling at Telfer was supported by QA/QC procedures consisting of:

- 15 different certified reference materials (CRMs), submitted at a rate of 1:20.
- 20 mm coarse blanks submitted at a rate of 1:40.
- Pulp duplicates submitted at a rate of 1:40.
- Crushed duplicates submitted at a rate of 1:40.
- Field duplicates from RC samples submitted at a rate of 1:40.

Documentation of QA/QC results reported acceptable QA/QC results with assay accuracy and laboratory precision within acceptable limits.

Newcrest - Independent Technical Specialist's Report

Grant Samuel & Associates Pty Ltd

0223041

Havieron

First drillholes at Havieron were drilled in 1991 and the latest exploration was completed in 2021. The geological model at the deposit is based on a total of 330 drillholes for a total of 218,184 m. Drilling was completed using mud rotary or RC through the cover, and diamond drilling to advance through the basement. PQ, HQ and NQ₂ diameter core was drilled on 6 m runs. A mine grid (HAV2020) has been set up and implemented as the primary grid datum for the model.

Drillhole collars were determined by handheld GPS and subsequently surveyed using differential GPS with Global Navigation satellite System. Downhole survey was collected at 5 m to 50 m using single shot (Axis Mining Champ Gyro).

Geological logging recorded a quantitative description of lithology, alteration, mineralization, veining and structure. Reported diamond core recovery was close to 100%.

Measurements of bulk density were completed for almost 8,000 diamond core samples taken nominally on 10 m intervals using water replacement method.

Sampling intervals range from 0.1 m to 2.5 m with sample preparation and assaying conducted at Intertek Laboratory in Perth. All samples were assayed for 48 elements using 4-acid digestion followed by ICP-AES/ICP-MS determination. Gold analyses were determined by 50 g fire assays with AAS finish.

QA/QC procedures included duplicate samples from crush and pulp samples at a rate of 1:20, CRMs at an approximate frequency of 1:20, and barren blank samples at the frequency of 1:40. Duplicate and CRM results show an acceptable level of variability, and blanks did not indicate significant grade contamination. Sampling, sample preparation and QC protocols are considered appropriate for this deposit type.

Camp Dome

The Camp Dome Mineral Resource estimate is based on the analytical information from 58 drillholes totalling 15 km, 42 of which were RC with the remainder diamond core, the majority of which were drilled in 2009 and 2010. Diamond drillholes were predominantly HQ diameter and RC drillholes were drilled with 133 mm hammer. All resource modelling has been completed in Mine Grid of Australia 1994 Zone 51 grid.

Downhole surveying was completed with multi-shot cameras with intervals from 5 to 30 m, all RC holes from 2009 programme were assumed vertical, and all 2010 holes were surveyed using a downhole camera.

RC drillholes were sampled at 2 m intervals of approximately 5 kg to 6 kg from a cone splitter. Diamond drillholes were sampled at 1 m fixed length intervals, logged, photographed, sawn in half and submitted for assay.

All samples were assayed for Cu, but many were also assayed for Au, Co, Bi, Ni, Pb, W, Zn, As and Fe. Copper and all other elements determinations were by either ICP at Genalysis Perth using peroxide fusion, HCl solution and ICP or Newcrest Laboratory in Orange with 2 acid digest and ICT-OEC method.

Bulk density values were determined from 31 measurements from one drillhole.

QA/QC protocol included field duplicates at 20 m intervals for RC holes, blanks and standards were submitted with a rate of 1:20 intervals. The QA/QC results were acceptable and industry standard.

Newcrest - Independent Technical Specialist's Report

Grant Samuel & Associates Pty Ltd

0223041

O'Callaghans

The O'Callaghans deposit had been explored by 184 drillholes including wedge holes for a total of 71.7 km. Typical drilling configuration was RC pre-collars and diamond drilling through the mineralization. First seven diamond holes were drilled in 1985, and the majority of holes were drilled between 2008 and 2010. A local grid has been defined for the O'Callaghans area, however, all drillhole data has been acquired in the Telfer Mine Grid 2002. Sampled intervals varied from 0.2 m to 2 m, but the majority of sampled intervals were either 1 m or 2 m. All available drillholes had downhole measurements and results of geological logging. The analytical database includes results for 26 elements, including W, Cu, Pb and Zn.

914 bulk density measurements from 73 holes were available from direct measurement using wet/dry weight calculations.

QA/QC protocol included standards and blanks that returned industry standard results.

Satellite deposits

Several companies have undertaken exploration in the areas of the deposits between 1972 and 2000. RC and diamond drillholes are the principal source of geological and analytical information for the Satellite deposits. While several RAB traverses were drilled prior to 1996, none of these holes were included into the modelling and estimation processes. Location of data points is expressed either in terms of local grids or AMG84 Zone 51 coordinates.

The RC drillholes were all 140 mm hammer holes using a face sampling-type hammer. The RC samples were riffle split on 1 m sample intervals. Diamond holes were drilled triple tube using NQ, HQ, or PQ sizes. NQ and HQ core was submitted as half core, 1 m samples. PQ core was submitted as half core, 0.5 m samples within mineralization and quarter core, 1 m samples in unmineralized zones. The core recovery information is limited to one drillhole, which was close to 100%.

All drillholes have been geologically logged for lithology, mineralization, alteration, weathering, structure and other physical properties. The Telfer Laboratory was used for sample preparation, and all samples were assayed at Amdel Laboratory in Perth for the suite of elements using fire assay with AAS finish for gold, cyanide solution with AAS for copper, and aqua regia for As, Bi, Co, Cu, Fe, Ni, Pb, S, Sn and Zn.

All drill rigs were positioned using surveyed collar pegs, and the downhole deviations of all holes were measured by either Tropari or Eastman multishot cameras. All hole collars were surveyed by mine surveyors on completion of the drillhole.

Pulp density data were used for the Mineral Resource estimate for the Telfer satellite deposits. These measurements were completed at Amdel laboratories in Perth using gas pycnometer. More than 10,000 measurements were collected for the Mineral Resource estimate.

QA/QC protocol included one field duplicate taken every 20 m, CRMs on a 1:20 basis, and coarse blank material on a 1:40 basis. It was concluded that the QA/QC results were acceptable.

3.3.4 Mineral Resource estimation methodology

All resource models for the Telfer assets are based on implicit wireframe modelling of lithological models, mineralization domains and weathering domains, which were developed in Leapfrog^(TM) software. Logging from all holes with exception of some grade control holes was used to develop full lithological models and oxidation surfaces.

Mineralization at the Telfer assets is represented by different types which are generally controlled by structure and lithology. Each mineralization type, such as open stockwork and reef, breccias, narrow high-grade reefs, sheeted vein-sets and large areas of mineralized material or

Newcrest - Independent Technical Specialist's Report

Grant Samuel & Associates Pty Ltd

0223041

polymetallic skarn were modelled separately in Leapfrog software using either logging results or grades.

All samples were length composited to 4 m intervals for Telfer Open Pit and Underground, though most of "raw" assays were 0.5 m, 1 m or 2 m intervals. A 2D accumulation method was used for estimation of all narrow reefs. Four metre sample length compositing was also used for the Dolphy and Big Tree satellite deposits and Camp Dome deposit, and two-metre sample length compositing for the Ironclad and O'Callaghans deposits. Five-metre sample length compositing was used for the Havieron model, even though the majority of intervals had one-metre sampling length.

Cell declustering was then performed in Vulcan^(TM) software for the stockwork and reef populations of gold, copper and sulphur, which was followed by top-cutting of all grades separately for each domain in each deposit.

Variography for all main domains was then completed and reported which was followed by block modelling. The parent cell and subcell size for different models was as follows:

- Telfer Open pit model was generated with parent cells of 12.5 mE by 12.5 mN by 12.5 mRL and maximum subcelling to 3.125 m in East and North and 1.0 m in RL.
- The parent cell size for Telfer Underground stockwork model was 10.0 mE by 10.0 mN by 10.0 mRL and maximum subcelling to 0.625 m in all directions.
- All thin reefs were modelled using parent cell size of 5 mE by 5 mE by variable vertical block size with minimum subcell size of 0.5 mE by 0.5 mE by 0.2 mRL.
- The Havieron model had parent cell size of 5 m in all directions without subcelling.
- The Camp Dome model had parent cell size of 50 mE by 50 mN by 10 mRL and subcelling down to 12.5 mE by 12.5 mN and 2.5 mRL.
- The O'Callaghans model had parent cell size of 50 mE by 50 mN by 5 mRL and subcelling down to 10 mE by 10 mN and 5 mRL.
- The Satellites models had parent cell size of 10 m in all directions and subcelling down to 2.5 m in all directions, except Dolphy which had minimum subcell size in easting of 5 m.

The Telfer stockwork grades were estimated using multiple indicated kriging (MIK) method. The Telfer Underground resource model is comprised of estimates for gold, copper, cyanide soluble copper, sulphur, arsenic, cobalt and density. The more tabular estimation domains were estimated using OK, whilst the bulk domains (Stockwork and VSC) were estimated using MIK. The main grades for the Havieron model were estimated using OK (for Au, Cu, As, Bi, Pb, Zn and NI), and ordinary co-kriging was utilised to estimate Fe, S and Co. OK method was also used to estimate copper, cyanide soluble copper and sulphur for the Camp Dome model, all metal inventory into the O'Callaghans model, and also for Au, Cu and S estimate to all Satellite models.

The block models were validated using visual and statistical methods, as well as using swath plots, and all models were classified to Measured, Indicated and Inferred Mineral Resources using block variances, drill density and calculated NSR profit cut-offs.

All block models reviewed were depleted for mining up to 30 June 2023 where mining occurred, and also constrained for reporting using constraining pit shells of NSR-based cut-off grades.

Figure 3.3 shows the Telfer Open Pit model below the current pit shell as of 30 June 2022. Figure 3.4 shows the Telfer Underground models and exploration grid drilling density. Figure 3.5 shows the Havieron model colour coded according to modelled lithological domains and exploration holes.

Annexure 1. Independent Expert's Report

Newcrest - Independent Technical Specialist's Report

Grant Samuel & Associates Pty Ltd

0223041

Figure 3.3 Telfer Open Pit resource model below existing pit surface (oblique view looking west)

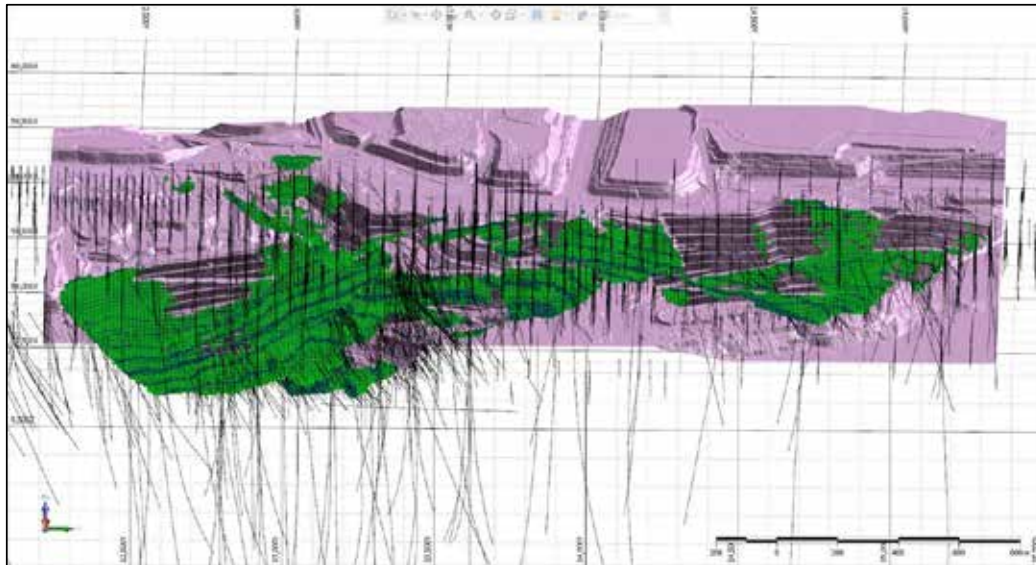

Source: Prepared by AMC from data provided by Newcrest

Figure 3.4 Telfer Underground resource models (oblique view looking east)

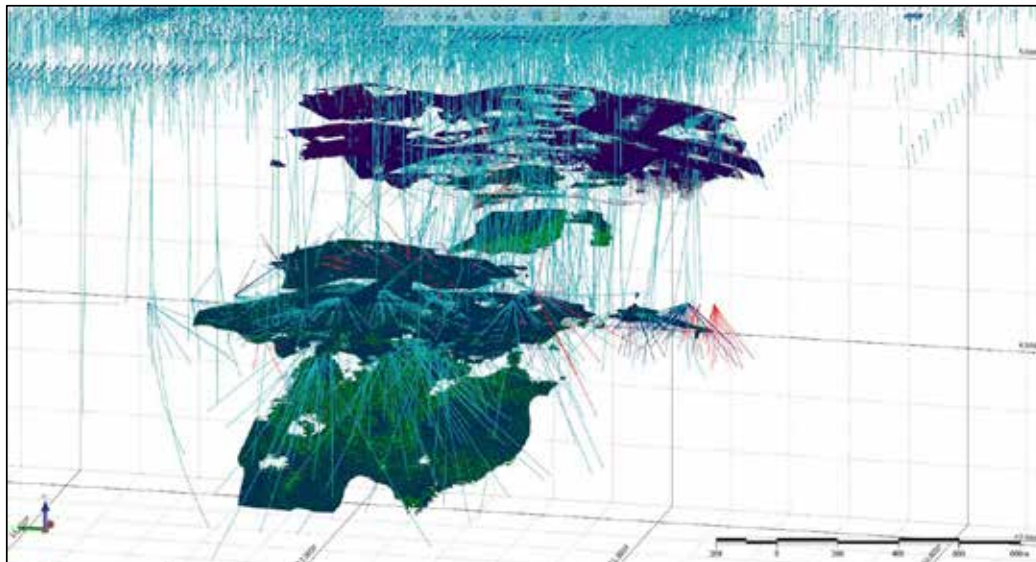

Source: Prepared by AMC from data provided by Newcrest

Newcrest - Independent Technical Specialist's Report

Grant Samuel & Associates Pty Ltd

0223041

Figure 3.5 Havieron resource model (oblique view looking east)

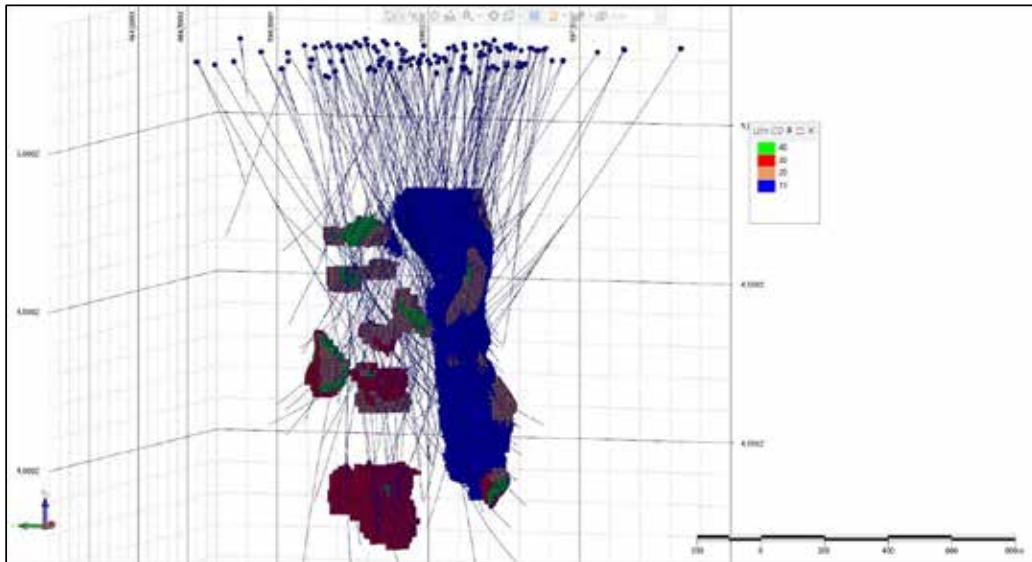

Source: Prepared by AMC from data provided by Newcrest

3.3.5 AMC estimation validation

AMC has independently interrogated the block models estimations as a global confirmation of grade for each deposit and each model using data and parameters supplied by Newcrest. This was undertaken using Micromine software. AMC closely replicated the Mineral Resources estimates for all models and all deposits as reported by Newcrest, allowing for rounding by Newcrest and the use of different software packages.

AMC viewed the drillholes against the block models and satisfied itself that the distribution of geology and grade is well represented by the block models. AMC also compared the results for each domain separately for Telfer Underground and satisfied itself that these are appropriately reported.

Swath plots of drillhole composites plotted against block model grades were reviewed by AMC and confirmed that the model correlates with the input data in location and scale.

3.3.6 AMC comments on the Mineral Resources estimates

AMC's conclusions for the Mineral Resources estimates are:

- Drilling, sampling, assaying, and acquisition of other data used for estimation of the Mineral Resources for all Telfer assets have been collected following accepted industry practice and established protocols. Analytical data used for grade estimations is supported by QA/QC procedures that follow accepted industry practice.
- The Mineral Resource estimates are based on a geological interpretation that reflects the geological control on grade distribution.
- AMC considers that the Mineral Resource estimate classifications, given the complexity of the geology and the drillhole data densities, are reasonable.
- AMC has used the block models provided by Newcrest to AMC to confirm that the tonnages, grades, and classifications reported in the Mineral Resource estimates can be reproduced. AMC confirmed this to be the case.
- The Mineral Resource estimates for all deposits with exception of Camp Dome, which was classified only as Inferred Mineral Resource, are appropriate to be used as the basis for Ore Reserve estimation.

Newcrest - Independent Technical Specialist's Report

Grant Samuel & Associates Pty Ltd

0223041

- Swath plots of drillhole composites plotted against block model grades were reviewed and confirmed the model correlates with the input data in location and scale.
- The Mineral Resource estimates for all deposits and domains followed accepted industry practice and are appropriately classified as Measured, Indicated and Inferred Mineral Resources in accordance with the JORC Code. AMC broadly concurs with the Mineral Resource estimate classification for all deposits.

3.3.7 Exploration and resource potential

The primary source of exploration and resource potential is as follows:

- Telfer Underground potential may occur at the deep levels of the Main Dome, which could be subject for additional exploration.
- Telfer Open Pit potential is limited by the existing infrastructure and pits, but that could change if commodity prices increase.
- The Havieron mineralization is still open at depth. Most of the breccia zones are currently classified as Inferred. Upgrade of their classification may increase the economic potential of the deposit.
- The Camp Dome mineralization is still open in several directions, and further exploration may support the classification upgrade.
- O'Callaghans deposit has limited exploration and resource potential due to the deposit type and the level of exploration completed to date.
- The majority of the Telfer Satellite deposits were classified as Inferred Mineral Resource with limited Indicated Mineral Resource in parts of the models. Further exploration may result in upgraded classification of the deposits and increased economic value, though the relatively small size of these deposits would mean that it is likely they may be considered for development together with other deposits.

3.4 Geotechnical investigations

Havieron has been studied at PFS level, according to Newcrest's study requirements which meet or exceed general industry standards. The geotechnical component was reported in a detailed chapter of the PFS. The appendices to this chapter, which include the detailed analysis to support the stope dimension recommendations and the numerical modelling to assess stress redistribution effects, were not available in the data room. Nonetheless, the geotechnical and mining reports summarise the results and AMC assesses that the main geotechnical issues are adequately understood for the current study.

The base case mining method proposed for Havieron is sub-level open stoping (SLOS) with cemented paste fill. Stope dimensions are based on detailed geotechnical assessments of drill core and application of industry standard design methods. The base case stope dimensions are considered reasonable in the assessed ground conditions, which are generally good. With the initially proposed mining sequence, some high stress conditions and stress-related damage were noted in the modelling results in the late-stage pillars and mining abutments. AMC notes that additional data will be collected in the next phase of study including overcoring stress measurements to inform an updated mine design.

At Telfer, the current sources of production are mostly from well-established mining methods in areas where the geotechnical conditions are well understood. Being a mature mine with extensive mining, management of stress-related issues is an important operational requirement and, in some areas, involves high-capacity ground support and strict observance of re-entry protocols.

Future conceptual mining areas under consideration at the existing Telfer Main Dome operation include the VSC which extends for about 500 m vertically below the existing SLC operation. Considering the depth (1200 m to 1800 m below surface) stress-related issues are likely to be significant and will require careful mine design and sequencing.

Newcrest - Independent Technical Specialist's Report

Grant Samuel & Associates Pty Ltd

0223041

Some stoping and SLC targets have also been identified as potential underground ore sources under the nearby West Dome. These are likely to be in comparable ground conditions to the existing Telfer operations and at similar or shallower mining depths. However, only limited drilling is currently available. Significant further work is required to investigate the geotechnical conditions in these potential future ore sources.

3.5 Mining operations and Ore Reserves

3.5.1 Current mining operations

Current mining operations at Telfer consist of an open pit mine mining the West Dome Resources and an underground mine extracting remaining material within historic workings. Underground mining at Telfer is expected to be completed during FY25 with open pit mining continuing through FY26. There are a number of studies continuing to evaluate additional plant feed from Telfer Mineral Resources.

Open pit mining occurs at the West Dome open pit, via multiple stages named stage 2, 4, 5, and 8. The operation utilises conventional truck and shovel mining on 12 m high benches. Most material mined requires blasting. The primary mining fleet comprises 530 t and 360 t class excavators and Caterpillar 793 (220 t) trucks. Mining is undertaken by a third-party open pit mining contractor under the direction and supervision of Newcrest. Current total material movement is 40 Mtpa, containing 20 Mtpa of ore.

Underground mining areas consist of a SLC beneath the Main Dome open pit and LHOS at the M Reefs and Western Flanks plus the A-Reefs and Rey production areas.

Mining of the SLC commenced in 2006 and will be completed in FY23. The SLC has been a key ore source for Telfer over the last 15 years.

The M Reefs recommenced in 2009. The M Reef mining method is LHOS with pillars. Stopes have a minimum width of 1.8 m and maximum vertical height of 20 m. Stope dilution and ore loss of 35% and 15% respectively are based on recent actual performance.

Western Flanks commenced in 2017 and is mined using LHOS with pillars. Stopes are designed as 15 m wide by 15 m high with pillars between stopes to maintain ground stability. Stope dilution and ore loss of 13% and 7% respectively are based on recent actual performance.

3.5.2 Future mine expansion

The proposed mine development plan for Telfer and Havieron post 2026 is outlined in section 3.5.4 of this ITSR.

3.5.3 Ore Reserves and estimation process

The Telfer and Havieron Ore Reserves estimate as at 30 June 2023 is summarized in Table 3.5. The Telfer Ore Reserve is based on a gold price of US\$1,600/oz and a copper price of US\$3.50/lb, and exchange rate of 0.75 US\$:A\$. The Havieron Ore Reserve is based on a gold price of US\$1,300/oz and a copper price of US\$3.00/lb, and exchange rate of 0.75 US\$:A\$. Havieron is reported on a 100% basis (Newcrest's share is 70%).

Annexure 1. Independent Expert's Report

Newcrest - Independent Technical Specialist's Report

Grant Samuel & Associates Pty Ltd

0223041

Table 3.5 Telfer and Havieron Ore Reserves as at 30 June 2023

Deposit	Tonnes Mt (Dry)	Grade		Contained Metal	
		Au (g/t)	Cu (%)	Au (Moz)	Cu (Mt)
Probable Ore Reserve					
Telfer Open Pit Stockpiles (NSR A\$22.50/t)	1.6	0.43	0.097	0.022	0.0015
West Dome Open Pit (NSR A\$22.50/t)	23	0.83	0.066	0.62	0.015
Telfer Underground (Variable NSR A\$46.55/t-A\$147.96/t)	2.0	2.1	0.69	0.14	0.014
Havieron (NSR A\$130/t)	14	3.7	0.54	1.6	0.073

Notes:

- All data reported on a 100% asset basis.
- New pit designs to include additional staged areas.
- Mining depletion partially offset by Ore Reserves increase due to Mineral Resource model update.
- A Feasibility Study for Havieron is currently in progress. Newcrest attributable share 70%.

Telfer Open Pit

The Telfer open pit Ore Reserves comprise the West Dome Stage 2, Stage 4, and Stage 5 cutbacks. New pit designs for the June 2023 Ore Reserves include additional staged areas over that included for June 2022.

Ore Reserves are based on a net value to account for revenue from both gold and copper. The net value uses the revenue less site operating costs, TCRCs, and royalties. Site operating costs include mining, processing, site administration and sustaining capital costs. The open pit was based on a NSR of A\$22.50/t milled.

The Telfer open pit resource model is a sub-blocked model with a parent block size of 12.5m x 12.5m x 12.5m that is sub-blocked down to a selective mining unit of 6.25m x 6.25m x 4m. based on historical performance a mining recovery of 95% is applied.

The Ore Reserves are based on mine designs, schedules, and cost and economic modelling. Modifying factors are based on Telfer operating performance.

Telfer Underground

A PFS completed in 2014 provides the supporting basis for the Telfer Underground Ore Reserves. The mine design and cost, recovery and economic assumptions are updated for the Ore Reserve estimate each year. NSR values equating to the incremental operating and sustaining capital costs are used for cut-offs at Telfer.

Mining factors (ore loss and dilution) are applied by area based on the performance of that area over the preceding 18 months.

Metallurgical recovery factors have been based on actual performance of current processing operations and vary for each resource with ranges of:

- Gold recovery – 81% to 96%
- Copper recovery – 82% to 97%

Newcrest - Independent Technical Specialist's Report

Grant Samuel & Associates Pty Ltd

0223041

Havieron

Havieron Ore Reserves are based on a PFS completed in 2021 which proposed a Sub-Level Open Stopping mining method at a mining rate of 2 Mtpa. NSR values equating to the mining, processing and relevant general and administration operating and sustaining capital costs are used for cut-offs at Havieron. The values applied were:

- Breakeven cut-off value – A\$130/t
- Marginal cut-off value – A\$115/t

Mining factors have been applied to stope shapes at average rate of 9% dilution and 2.5% ore loss. Dilution is added at zero grade.

Metallurgical recovery factors have been based on testwork completed during the PFS and previous studies and are anticipated to average:

- Gold recovery – 88%
- Copper recovery – 84%

The Havieron Ore Reserve mine design is shown in Figure 3.6.

Figure 3.6 Havieron Ore Reserve mine design – longsection looking north

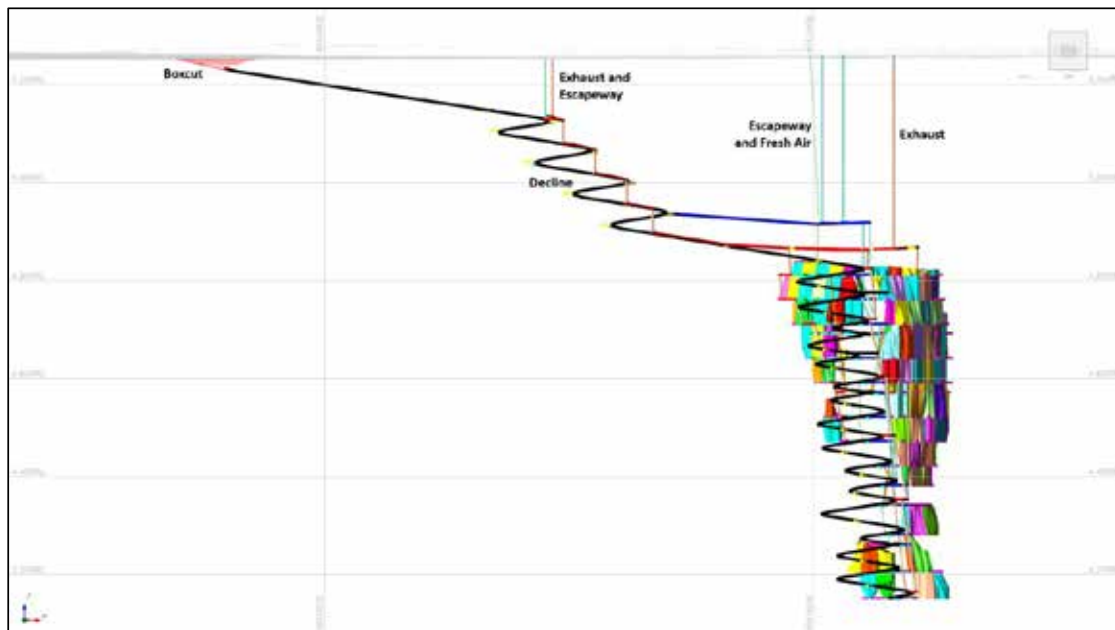

3.5.4 Resource development and future mining concepts

The longer-term future of Telfer beyond FY26 is based on underground mining of multiple projects, including the Havieron project and multiple near Telfer opportunities.

Havieron is a proposed greenfield copper-gold mine located 45 km from Telfer. The project is operated by Newcrest under a joint venture agreement with Greatland Gold plc (Greatland). Newcrest assumed project management in 2019 and has been managing the deposit definition and technical studies since then. The project is currently subject of an ongoing feasibility study.

It is proposed to develop Havieron in two stages. Stage 1 includes the construction of a box-cut, exploration decline and associated infrastructure. These activities commenced in January 2021. The exploration decline has currently advanced approximately 1,800 m. Stage 2 is planned to

Annexure 1. Independent Expert's Report

Newcrest - Independent Technical Specialist's Report

Grant Samuel & Associates Pty Ltd

0223041

comprise of the underground and surface development required to establish mining operations, and construction of a 55 km haul road and power line to Telfer. Mined ore will be transported to Telfer for processing through the Telfer processing facility.

A PFS was prepared in late 2021 for Havieron. The PFS, based on the March 2021 resource model and considering all resource categories in the model, outlined a mine plan utilising a SLOS underground mining method with paste backfill at a rate of up to 2 Mtpa and mine life of 11 years. The PFS identified several future growth targets such as NE Crescent, Northern Breccia and Eastern Breccia that were not sufficiently advanced to include in the PFS.

The PFS also assessed a bulk mining option using SLC with a mining rate of 6 Mtpa. The SLC option did not deliver a positive economic outcome and was identified to have multiple risks including a high level of unclassified mineralisation, difficult cave initiation, early dilution from the Permian cover and inrush potential that resulted in the selection of the SLOS option.

Near Telfer potential future ore sources are shown in Figure 3.7. The more significant opportunities are the VSC, West Dome Deeps (WDD) and MVS South. These and the other opportunities shown in Figure 3.7 are at an early stage of project maturity, with significant technical and economic studies required to advance the projects prior to a final investment decision.

Figure 3.7 Telfer Underground – potential future ore sources

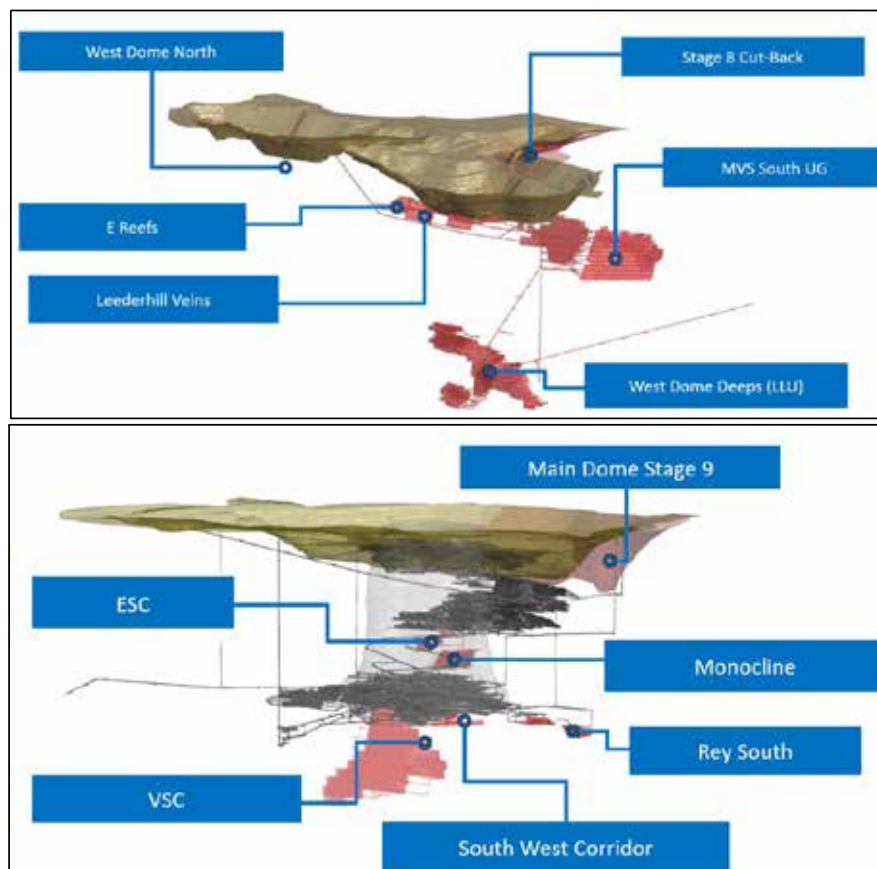

The VSC is located directly underneath the SLC. A concept study was prepared in early 2022 to provide an initial assessment of the deposit potential. The study considered the potential for

Newcrest - Independent Technical Specialist's Report

Grant Samuel & Associates Pty Ltd

0223041

mining rates of 2 to 4 Mtpa using SLC mining methods. Potential risks identified include initiating mining under the completed SLC, geotechnical constraints associated with the depth of mining and interaction with the completed SLC immediately above, and economic potential.

The West Dome Deeps is located approximately 1.5 km to the northwest of the current SLC. A concept study was prepared in mid-2022 based on unclassified material as there were no JORC Code resources at this stage of project development. It is proposed to access the WDD from existing underground development via a 1.6 km development drive. The study outlined the potential for mining rates of up to 1 Mtpa with a 10-year mine life using LHOS mining methods.

An ore production profile indicating the future for the combined operation is being investigated by Newcrest with potential to extend the life of Telfer for many years albeit at a lower production rate.

3.6 Mineral processing

3.6.1 Processing plant description

Plant feed is made up from approximately 75% open pits and 25% underground and due to the different mineralization of these ores the copper head grade will vary. Milling throughput is 22 Mtpa via dual comminution circuit followed by flotation and cyanide circuits, which produce gold doré and a copper-gold concentrate. The processing plant produces a copper concentrate which contains large amount of gold with between 70 g/t Au to 90 g/t Au. The copper concentrate grade is low, between 9% Cu to 11% Cu and the main diluent is non-sulphide gangue minerals.

Pyrite (iron sulphide) is the major sulphide mineral along with copper sulphides. A gravity circuit is also used to recover coarse free gold liberated by grinding. The gold is found to exist across a broad particle size range and the majority is recovered by flotation as it is closely associated with the copper sulphide minerals. A small amount of the gold is recovered by cyanide leach.

Summary of all major ore processing equipment includes:

- 2 x primary crushers.
- 2 x sag mill, 36-foot diameter, with 4 x pebble recycle crushers.
- 2 x ball mills in closed circuit, 24-foot diameter.
- 2 x flash flotation cell and 4 x gravity concentrator processing hydrocyclone underflow.
- 2 x trains of flotation cells of rougher and scavenger cells with conventional cleaning cells.
- 2 x Jameson cleaner flotation cells.
- 2 x regrind ISAMills, M3000 and M5000.
- pyrite leaching circuit to produce gold doré.
- cyanide recovery circuit.
- 2 x tailings thickeners, 1 x concentrate thickener, and 1 x pyrite circuit thickener.

Newcrest - Independent Technical Specialist's Report

Grant Samuel & Associates Pty Ltd

0223041

Figure 3.8 Processing plant flow sheet for Telfer

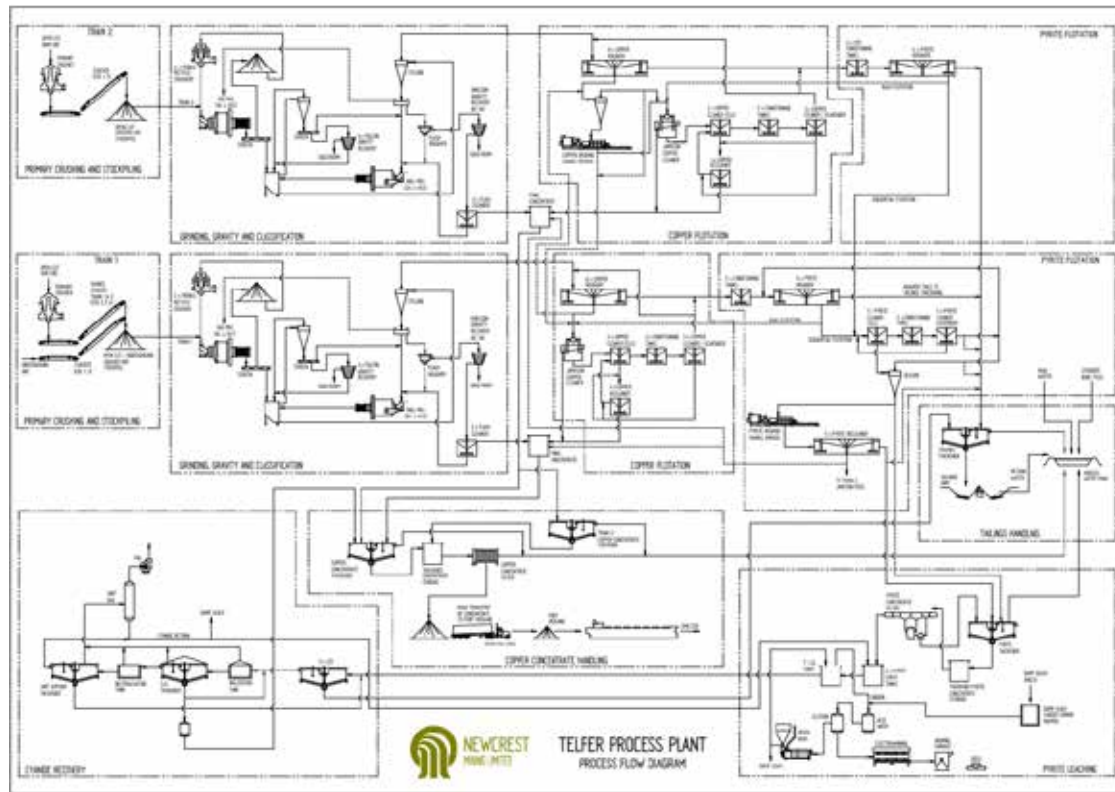

3.6.2 Metal recovery and concentrate grade

Gold recovery over a recent twelve months (March 2022 to February 2023) has averaged around 82% and copper recovery around 69% with a copper concentrate grade of 9.6%. There is additional revenue with silver recovered from final products (Source: Telfer 3y actuals).

3.6.3 Concentrate transport and marketing

Concentrate sales have averaged 12,900 dmt per month for a recent twelve months (March 2022 to February 2023), containing an average of 33,079 oz/month and 1,237 t Cu/month.

Concentrate is transported by road to Port Headland, approximately 450km away.

3.6.4 Tailings storage

Current tailings are stored in TSF8 which was commissioned in 2021 and has become the primary storage facility. TSF7 facility has been in use for the past ten years is approaching capacity. The plan is to raise TSF8 as quickly as practical by a combination of downstream and centreline raising to equalise the crest elevations of TSF7 and TSF8. The purpose of this is to limit risk of instability due to the shared embankment wall. Ultimately the aim will be to reduce the rate of rise in the upstream TSF7 and work towards and create single landform across the two dams.

The dam designs are such to reduce water stored as much as practical through recycling. The water balance has indicated no need for an external water storage dam to provide additional capacity for storage and/or evaporation. At the design production rates planned, it is anticipated that over 15 years of storage.

Newcrest - Independent Technical Specialist's Report

Grant Samuel & Associates Pty Ltd

0223041

The most recent review of the TSF facilities found both dams to be in satisfactory condition. A number of low to medium risk findings were documented and Telfer Tailings Management team are addressing these in order of priority. No high-risk findings were identified.

3.6.5 Future ore processing plans

Telfer is the largest processing facility in the Paterson Province and has sufficient capacity and capability to process other discoveries in this region. Telfer's near mine environment contains a number of exploration targets with the potential to deliver new growth with a number of other prospective gold and poly-metallic deposits in the area covered by Newcrest's existing mining and exploration tenements.

A feasibility study for Havieron is underway following which the project is expected to move towards development. The ore will be processed using Telfer existing methods and infrastructure to maintain a low-risk cost profile. It is likely that the existing Telfer processing plant could be cost efficiently rescaled to approximately 6Mtpa to match the feed rates.

3.7 Site infrastructure and services

3.7.1 Power supply

Two permanent power stations have been set-up at the Telfer site with the Primary Power Station (comprised of three gas turbines) and the Secondary Power Station (comprised of eight diesel generators). The Primary Power Station was originally designed with duty and one standby, however as site has increased in size and therefore power demand, there are also twelve 1MW Aggreko units to supplement power.

A 450 km dedicated natural gas pipeline was installed from the beginning as it was impractical to truck in gas for the power station. This is operated by Santos and Apache Energy for the sole use of Telfer Mine site and Nifty mine site.

3.7.2 Water supply

The mine site relies on abstraction of groundwater from a series of bore holes for both raw and potable uses. Total installed bore field peak capacity of 80 MLpd. Water is used for ore processing, dust suppression, washdown, and firefighting needs.

3.7.3 Other infrastructure

Most consumables are brought to site via the main access road which is a private road maintained by Telfer Mining Operations and incorporated into the Western Australian main roads and in the Shire of East Pilbara.

The majority of the workforce is FIFO from Perth (1,310 km away) and are housed in on-site accommodation (>2000 rooms) and facilities.

Newcrest - Independent Technical Specialist's Report

Grant Samuel & Associates Pty Ltd

0223041

3.8 Environmental, Social, and Permitting

3.8.1 Environmental and regulatory approvals background

Telfer is an open pit and underground gold-copper mine with ore processing facilities. The operation also includes a 160 MW gas-fired power station supplied by natural gas piped from Port Hedland, as well as associated infrastructure such as waste rock landforms, tailings storage facilities, stockpiles, laydown areas, access roads, accommodation village, and borefields.

Telfer is owned and operated by two Newcrest entities, Newcrest Mining Limited and its subsidiary, Newcrest Operations Limited. Telfer was constructed in 1975 by Newmont Australia and was operated until 2000, when it was placed under care and maintenance. Ownership of Telfer was transferred to Newcrest Mining Limited (Newcrest) and in 2001-02, two related proposals were referred to the WA EPA for assessment:

- Telfer Project Power Supply and Infrastructure Corridor (Assessment 1444).
- Telfer Project Mine and Borefield Extensions (Assessment 1445).

Following assessment, the Minister for the Environment published Ministerial Statements No. 605 (MS605) and No.606 (MS606) in October 2002, formally approving the Telfer Project power supply and corridor, and mine and borefield extensions respectively. In May 2004, the Minister subsequently published Ministerial Statement No. 650 (MS650) for the purpose of adding a condition (Fauna Management – Open Trench) to MS605. Since then, four amendments have been made to MS606, which were associated with relatively minor project expansions.

Havieron is a greenfield gold-copper deposit designed to combine with Telfer (the Amended Proposal), and it is proposed to supersede MS605, MS606 and MS650 with a single Ministerial Statement and development envelope.

Key aspects of the Amended Proposal include:

- The open pit and underground mining and subsequent processing of gold-copper ore at Telfer, with associated facilities including a 160 MW natural gas-fired power station, waste rock landforms, tailings storage facilities, accommodation village and bore fields.
- A 440 km-long natural gas pipeline corridor from Port Hedland to Telfer.
- The underground mining of gold-copper ore at Havieron for processing at Telfer, approximately 55 km west, as well as the continued and/or expanded use of existing associated facilities at Havieron, including the underground decline to access the orebody, waste rock landforms, evaporation ponds, stockpiles, and accommodation village.
- Realignment and upgrading of the Infrastructure Corridor between Telfer and Havieron to facilitate transport of ore and other materials between Havieron and Telfer, including waste rock materials for progressive backfilling of the Havieron mine, and installation of a pipeline for water supply and a powerline within the corridor.

Development of Havieron to date has involved exploration and early works (Stage 1) activities conducted under other approvals. These approvals are for project assessment purposes and do not allow for mining of ore. Approvals obtained to date include the following:

- Clearing of native vegetation – various programmes of works have been issued under the *Mining Act 1978*, authorising up to 124 ha of clearing. This is mostly undergoing rehabilitation at present. A clearing permit (purpose) (9035/1) was issued for no more than 153 ha within M45/1287 and is valid to 18 December 2025.
- Ground disturbing activities (exploration drilling, construction of the underground decline and waste rock landforms) – various programmes of work issued for exploration activities. Mining activities on M45/1287 and L45/582 associated with Stage 1 of the project have been constructed as per Mining Proposal Reg ID 89453, approved September 2020.
- Groundwater abstraction/dewatering – the following Licence to Take Water (Section 5C) approvals are in place: groundwater licence (GWL) 204105(1) for abstraction of 20,000 kL

Newcrest - Independent Technical Specialist's Report

Grant Samuel & Associates Pty Ltd

0223041

- on E45/2962, E45/3261, E45/4701 and L45/537 and GWL202749(3) for the abstraction of 260,000 kL on M45/1287.
- Water and wastewater treatment – Department of Health permit held for a potable water treatment facility and a sewage treatment facility.
- Development of a waste rock landform for approximately 260,000 m³ of material from the approved box cut and decline.
- Evaporation ponds for disposal of mine water.
- Access roads and mine infrastructure such as sheds, offices, and workshops.
- A landfill facility.
- Vehicle washdown bay.

3.8.2 Environmental and social assessments, control, and management

3.8.3 Future approvals

Stage 2 of Havieron has been referred to the EPA (2023) and DCCEEW (2021) due to potential significant impacts to Matters of National Environmental Significance (Greater Bilby and Night Parrot). DCCEEW has determined Havieron to be a Controlled Action with assessment required. DCCEEW will undertake the assessment based on preliminary documentation.

Approvals still required for Stage 2 of Havieron include:

- Part IV EP Act approval – EPA referral (submitted March 2023).
- EPBC Act approval – EPBC Act referral (submitted October 2021).
- Works approval and prescribed premises licences:
 - amendment to the Telfer Licence (L6079/1988/13) to allow Havieron ore processing and discharge of tailings.
 - Works approval/licence amendment required to construct additional evaporation ponds and a paste processing plant.
- Mining proposals cover the Approved proposal, but amendments will be required to allow ore processing for Havieron and discharge of tailings, in addition to the supply of water, tailings and waste rock. The Havieron Stage 1 has an approved mining proposal (Reg ID 89453) and closure plan (Reg ID 101161). These will need to be revised to include Stage 2 works.
- Native vegetation clearing permit – a permit has been approved for 153 ha on M45/1287 (CPS9035/1). Stage 2 operations will not require a further permit if assessed under Part IV of the EP Act.
- Construct or alter a well and a groundwater licence – For Telfer, GWL150758(16) provides for the abstraction of 29,700,000 kL on Telfer tenements for dewatering for mining purposes, dust suppression, earthworks and construction purposes, mineral exploration, and ore processing. Abstraction is monitored and managed in accordance with the Telfer Groundwater Licence Operating Strategy. An amendment to GWL 150758(16) will be required for the supply and use of Telfer water to Havieron. An amendment to GWL202729(3) has been submitted to increase the abstraction of up to 1,550 ML/annum for Havieron. Any amendments to GWLs will require revision of the Groundwater Licence Operating Strategy.

3.8.4 SEB offsets

The Amended Proposal has been designed to avoid impacts to the primary habitat of two Threatened fauna species: the Greater Bilby and the Night Parrot. Management measures are already in place for approved disturbance areas to ensure impacts to secondary habitat as well as individuals of these two species (and others) are minimised. The Amended Proposal requires the removal of 603 ha of native vegetation (not previously approved) which is secondary foraging habitat for the Night Parrot. The requirement for offsetting this disturbance area has been

Newcrest - Independent Technical Specialist's Report

Grant Samuel & Associates Pty Ltd

0223041

acknowledged by Newcrest as being necessary for the proposed additional clearing and an Offsets Strategy has been developed.

3.8.5 Greenhouse gas emissions and renewable energy targets

Telfer reported Scope 1 and 2 emissions of 498,133 and 189 tCO₂^e respectively for the FY22 reporting period. The majority of the Scope 1 emissions arise from use of diesel for power generation.

Havieron reported Scope 1 and 2 emissions of 9,005 and 0 tCO₂^e respectively for the FY22 reporting period.

The emissions intensity by tonne of ore milled for Telfer for FY22 was 24 kg CO₂^e compared to the Newcrest average of 33 kg CO₂^e. No intensity data was calculated for Havieron given its small emissions profile.

AMC notes that the total Scope 1 emissions from the combined projects are lower than the emissions provided for under MS605 for the primary power station alone, largely because of lower than anticipated levels of activity and increased efficiencies across the board. Additionally, corporate and project-specific greenhouse gas reduction measures are proposed to be implemented to ensure the target of Net Zero is met by 2050. This is described in a Draft Greenhouse Gas Management Plan (unsighted) that has been provided as part of the Amended Proposal to replace the plan approved under MS605 and MS606.

3.8.6 Cultural Heritage

A number of Aboriginal communities are located in the region. The Jamukurnu Yapalikurnu Aboriginal Corporation (JYAC) holds native title rights and interests on behalf of the Martu People over 136,000 km² of land within the Central Western Desert region, including the area covered by the mine site and the infrastructure corridor.

JYAC and Newcrest have been working together since 2015 to develop a collaborative approach with Martu communities to document aspirations for managing their cultural landscapes and to collect information on community perceptions of Newcrest and potential impacts of the Amended Proposal. In addition to the work completed to date, Newcrest and JYAC have agreed to a community engagement programme to support the progression of Havieron's social impact assessment and other technical studies. This includes both workshops with JYAC and ongoing community engagement regarding Havieron.

It has been identified that an Indigenous Land Use Agreement cultural landscape management plan needs to be developed by Newcrest in conjunction with JYAC. JYAC is leading the development of the CLMP in partnership with Newcrest. This plan is proposed to assist the Martu to understand any potential residual and cumulative impacts on their lands and to document aspirations for cultural and environmental management. It will form part of a wider planning framework that includes an Indigenous Land Use Agreement Land Management Plan and a Biodiversity Offsets Strategy in a proposed Indigenous Protected Area. The overall aim is the long-term protection of Martu cultural landscapes and values.

Newcrest has worked with the Martu to ensure impacts on sites, features and areas of cultural significance have been avoided or minimised to an acceptable level. The proposed future activity areas have been surveyed in conjunction with the Martu People for cultural heritage values. It is noted that together with JYAC, Newcrest is taking a Paterson Province-wide approach to the management and protection cultural heritage values.

Newcrest - Independent Technical Specialist's Report

Grant Samuel & Associates Pty Ltd

0223041

3.8.7 Rehabilitation and closure planning

Closure plans

Closure plans have been developed and approved for Telfer in 2020 and Stage 1 Havieron in 2021. The MCP for Stage 2 (unsighted) Havieron has been developed but is still under assessment by WA Department of Mines Industry Regulation and Safety (DMIRS).

The Telfer closure plan covers three open pits, an underground operation, eleven WRDs, eight TSFs (across two landforms), five dump leach pads (across three landforms), processing plant and supporting infrastructure, covering an area of approximately 5,044 ha. The key domains include:

- Mine workings (538 ha).
- Landforms (1,415 ha).
- Tailings Storage Facilities (740 ha).
- Ore processing and handling infrastructure (20 ha).
- Non-process infrastructure (372 ha).
- Roads, borrow pits and hardstand areas (1,959 ha).

Progressive rehabilitation has been undertaken on WRD 10, WRD 13, WRD 6, and the Outer Siltstone Member WRD as well as rehabilitation of some low impact disturbance areas such as borrow pits and tracks. The top surface of TSFs 1, 2 and 3 have also been rehabilitated to date.

The Havieron Stage 1 MCP covers an area of approximately 772 ha and includes the following key domains:

- Waste Rock Landform, landfill, topsoil stockpile (152 ha).
- Boxcut and borrow pits (102 ha).
- Decline and underground workings (0 ha).
- Laydown areas, ROM pad, camp, admin area, carpark, workshop, fuel farm, batch plant, paste plant, emulsion storage, communication tower, wastewater treatment plant, irrigation area, vent raise, landfill, powerlines, explosives magazine (151 ha).
- Exploration drill pads, laydown, access tracks, core shed and sumps (2 ha).
- Access roads (248 ha).
- Dewatering bores, production bores, pipeline, evaporation ponds, raw water pad (117 ha).

It is unclear to AMC whether any rehabilitation works have been conducted to date, relevant to the Stage 1 MCP domains.

Closure cost estimate

An independent specialist consultant was commissioned by Newcrest to develop a 2022 closure cost estimate. The estimate was for a combined Telfer-Havieron closure for Telfer LOM and Havieron (100%) of A\$478.1M including contingency. The cost estimates were prepared in accordance with the global good practice standards defined in the International Council of Mining and Metals (2019).

3.8.8 Conclusions

Based on the information provided by Newcrest, it appears that all relevant approvals required to be gained for the Telfer-Havieron Amended Proposal, have been identified. This includes recent referrals to State and Commonwealth regulatory bodies. The extent and content of any conditions set if approval is granted is unknown at this stage, and closure costing estimates have been made with certain assumptions that may also be affected by conditions of approval.

Annexure 1. Independent Expert's Report

Newcrest - Independent Technical Specialist's Report

Grant Samuel & Associates Pty Ltd

0223041

3.9 Costs

3.9.1 Operating costs

Historical operating costs for the Telfer operation are summarised in Table 3.6. Unit costs for mining, processing, and G&A are shown in Table 3.7.

Table 3.6 Telfer historical operating costs

Operating Costs	Units	FY21	FY22	FY23
Surface mining	A\$M	204.3	226.0	262.8
Underground mining	A\$M	202.5	202.7	193.8
Processing	A\$M	211.8	236.2	259.1
Engineering	A\$M	25.1	27.1	29.2
G&A	A\$M	112.2	70.8	84.0
Concentrate transport	A\$M	18.7	31.7	32.6
TCs/RCs and Penalties	A\$M	58.4	65.6	73.3
Royalty	A\$M	33.7	38.6	34.8

Source: Various Newcrest reports, public documents and company advice.

Table 3.7 Telfer historical unit operating costs

Activity	Units	FY21	FY22	FY23
Open Pit – mining	A\$/t mined	4.51	6.29	7.05
Ex-pit – mining	A\$/t mined	4.07	5.66	6.29
Underground – mining	A\$/t mined	99.79	86.70	96.80
Processing	A\$/t ore milled	11.81	11.58	13.84
G&A	A\$/t ore milled	6.90	4.23	5.35

FY23 total site unit costs are 5% above budget. Open pit mining unit costs are 9% over budget due to higher diesel costs and mining contactor costs, processing unit costs are 9% over budget and G&A unit costs are 12% over budget due to 7% lower than budget tonnes processed. Underground unit mining costs were slightly below budget.

FY22 total site unit costs were close to budget. Open pit mining unit costs were 10% over budget due to higher diesel costs and mining contactor costs, and underground mining unit costs over budget due to lower than budget ore tonnes mined (30% lower due to unavailability of planned mining locations, delayed commencement of mining in one ore zone whilst undertaking the geotechnical assessment and personnel issues).

FY22 total site unit costs were 5% over budget. Underground mining unit costs were 80% over budget due to lower than budget ore tonnes mined (45% lower due to haulage constraints, below budget development rates not providing the planned mining locations, dewatering issues, and geotechnical issues). Other areas were close to budget.

3.9.2 Capital expenditure

Newcrest provided AMC with a capital expenditure profile with the LOM production and cost schedule. AMC has reviewed these capital expenditure estimates and believes they are generally reasonable. AMC has adjusted capital expenditure estimates where it was considered necessary for the AMC production cases, discussed in section 3.10.

Telfer and Havieron capital costs are summarised as totals in Table 3.8. The Telfer estimate is from the Newcrest LOMP. The Havieron capital shown here is from the 2021 PFS and includes pre-FY24 expenditure.

Newcrest - Independent Technical Specialist's Report

Grant Samuel & Associates Pty Ltd

0223041

3.10 AMC production cases

AMC developed production cases based on the Newcrest LOMP for Telfer and Havieron together with supporting information and AMC adjustments based on its observations and opinions. The schedules are presented on an annual basis.

Based on the information provided by Newcrest, discussions with Newcrest personnel, and observations made during AMC's site visit, AMC developed two production cases:

- AMC Production Case 1 is based on the higher confidence components of the Newcrest LOMP physicals, comprising Ore Reserves and some Mineral Resource. This case reflects AMC's adjustments to timing of mine development and mining costs and an adjustment to the capital cost profile.
- AMC Production Case 2 represents the Newcrest LOMP which AMC considers is the upper reasonable limit of the potential for Telfer, with adjustments to timing of mine development and mining costs and an adjustment to the capital cost profile.

Newcrest provided an estimate of capital expenditure for Telfer and Havieron. This estimate comprises an estimate for sustaining capital and non-sustaining capital expenditure as listed in Table 3.8. This estimate is based on feasibility and pre-feasibility studies, historical costs, and other estimates. The non-sustaining capital expenditure is to establish additional underground production sources and some remaining mill expansion expenditure.

Newcrest is in the process of updating the combined Telfer and Havieron capital cost forecast. However, at the time of preparing this ITSR, the work was not complete. Interim results were provided to AMC and adjusted where, in AMC's opinion, that was necessary to reflect scope and inflation increases. The revised capital cost was included in AMC's production cases.

Table 3.8 Telfer-Havieron estimate of capital expenditure

Capital Area	AMC Production Case 1 Capital Cost (A\$M)	AMC Production Case 2 Capital Cost (A\$M)
Sustaining capital cost	559	838
Non-sustaining capital cost	924	1,122
Total capital cost	1,483	1,960

Source: Newcrest. Summarized by AMC.

Note: Havieron capital is 100% basis.

3.10.1 AMC Production Case 1

AMC Production Case 1 is based on the Newcrest LOMP and consideration of the stated Mineral Resources and Ore Reserves. AMC has made the following key adjustments which are based on reasonable grounds:

- Delayed the start of ore production from Havieron and Telfer from 2027 to 2028. This will allow time for studies and development strategies to be defined (particularly for Telfer additional resources which are not as advanced as Havieron). Additionally, Telfer lateral development started the same year as ore production – development metres have been left starting in 2027. The delay also allows for plant modifications in FY27.
- The VSC resource which extended the existing Telfer SLC at depth has been removed. Mining an extension of the SLC is expected to be challenging due to adverse geotechnical conditions and mining costs are expected to be higher than shown in the Newcrest LOMP. With the expected higher costs of mining and lower grade of this resource it is AMC's opinion that this material is at risk of not converting to Ore Reserves.
- The WDD material has been removed. This material is not part of the Telfer Ore Reserves or Mineral Resources.
- Telfer mine development metres have been reduced to reflect the lower ore production tonnes.

Annexure 1. Independent Expert's Report

Newcrest - Independent Technical Specialist's Report

Grant Samuel & Associates Pty Ltd

0223041

- Capital costs for WDD and VSC have been removed.
- Havieron physicals are based on one of two development plans for Havieron, the Ore Reserve mine plan, at 2 Mtpa, which is a production rate most likely to be achieved out of a single decline with the orebody starting at approximately 400 m below surface.
- Inferred SE Crescent has been removed as this is used to maintain the production rate at 3Mtpa at Havieron.
- Eastern Breccia & Pods have been removed as these are mined alone at end of Havieron mine life without support of material from Telfer.
- Underground mining efficiency initiatives cost savings for both Telfer and Havieron have been removed. Estimated costs are lower than would be expected without cost savings.
- Havieron mining costs have been inflated by 40%. This brings Havieron unit costs closer to but still below a typical 2 Mtpa LHOS operation.
- Telfer capital costs have been delayed 1 year to align with the ore production. The exception to this was the first planned TSF expansion capital which was left in FY24.
- Havieron capital costs from FY26 have been delayed 1 year to align with the ore production. \$16M of early works moved from FY24 to FY25. FY24 study costs spread over FY24 and FY25.
- Initial capital costs for Havieron infrastructure and mine development from the Newcrest LOMP have been adjusted to reflect production levels and industry cost.

A summary of AMC Production Case 1 is included Table 3.9 and Table 3.10.

Table 3.9 AMC Production Case 1 – Telfer-Havieron production schedule

Estimate	Units	FY24	FY25	FY26	FY27	FY28	FY29 to FY38	FY39 to FY48	Total
Underground ore mined	Mt	1.1	-	-	0.5	2.5	17.7	-	21.9
Open pit ore mined	Mt	23.4	6.6	6.6	-	-	-	-	36.6
Leach Ore Treated	Mt	1.2	0.1	-	-	-	-	-	1.3
Leach Ore Gold Grade	g/t	0.25	0.38	-	-	-	-	-	0.26
Ore milled	Mt	21.3	10.5	8.0	-	3.1	17.7	-	60.6
Copper feed grade	%	0.09	0.05	0.05	-	0.41	0.42	-	0.2
Gold feed grade	g/t	0.7	0.5	0.5	-	3.4	3.0	-	1.4
Copper recovery	%	70.7	62.5	62.5	-	88.2	88.0	-	74.1
Gold recovery	%	79.2	73.9	73.0	-	87.7	88.3	-	80.5
Concentrate produced	kt	117	43	33	-	54	362	-	609
Copper in concentrate	kt	14	3	3	-	11	65	-	95.6
Gold in concentrate and doré	koz	399	122	92	-	293	1,479	-	2,385

Notes:

- The values in the table are subject to rounding.
- Concentrate produced is in dry metric tonnes.
- Havieron is 100% basis.

Newcrest - Independent Technical Specialist's Report

Grant Samuel & Associates Pty Ltd

0223041

Table 3.10 AMC Production Case 1 – Telfer-Havieron cost schedule

Cost estimate	Units	FY24	FY25	FY26	FY27	FY28	FY29 to FY38	FY39 to FY48	Total
Operating Costs									
Mining	A\$M	393	76	76	66	223	1,572	-	2,406
Processing	A\$M	241	168	128	0	94	590	-	1,222
G&A, fixed	A\$M	100	106	121	140	84	581	-	1,132
Capital Expenditure									
Growth capital	A\$M	108	24	248	434	71	40	-	924
Sustaining capital	A\$M	52	32	17	66	120	272	-	559
Rehabilitation	A\$M	8	8	8	8	8	161	192	391

Note: Havieron is 100% basis.

3.10.2 AMC Production Case 2

AMC Production Case 2 is based on the Newcrest LOMP and consideration of the stated Mineral Resources and Ore Reserves. AMC has made the following key adjustments which are based on reasonable grounds:

- The WDD material has been removed. This material is not part of the Telfer Ore Reserves or Mineral Resources.
- Mine lateral development for Telfer have been brought forward one year so development and ore production are not starting in the same year.
- Capital costs for WDD have been removed.
- VSC SLC stoping costs at Telfer increased from A\$20/t to A\$30/t. Mining conditions experienced in the bottom levels of the SLC are understood by AMC to have been challenging and are expected to become more so as it continues at depth.
- Underground mining efficiency initiatives cost savings for both Telfer and Havieron have been removed. Estimated costs are lower than would be expected without cost savings.
- Havieron physicals are based on the Ore Reserve and Inferred Mineral Resource mine plan at 3 Mtpa (Newcrest LOMP).
- Havieron mining costs have been inflated by 30%. This brings Havieron unit costs closer to a typical 3 Mtpa LHOS operation.

A summary of AMC Production Case 2 is included Table 3.11 and Table 3.12.

Table 3.11 AMC Production Case 2 – Telfer-Havieron production schedule

Estimate	Units	FY24	FY25	FY26	FY27	FY28	FY29 to FY38	FY39 to FY48	Total
Underground ore mined	Mt	1.1	-	0.7	3.5	6.1	42.5	1.0	55.0
Open pit ore mined	Mt	23.4	6.6	6.6	-	-	-	-	36.6
Leach Ore Treated	Mt	1.2	0.1	-	-	-	-	-	1.3
Leach Ore Gold Grade	g/t	0.25	0.38	-	-	-	-	-	0.26
Ore milled	Mt	21.3	10.5	8.0	4.2	6.1	42.6	1.0	93.7
Copper feed grade	%	0.09	0.05	0.05	0.46	0.34	0.33	0.36	0.23
Gold feed grade	g/t	0.7	0.5	0.5	2.4	2.1	2.4	3.6	1.6
Copper recovery	%	70.7	62.5	62.5	88.2	87.8	88.2	87.2	85.2
Gold recovery	%	79.2	73.9	73.0	88.0	88.9	88.5	87.4	83
Concentrate produced	kt	117	43	33	82	99	730	18	1,122
Copper in concentrate	kt	14	3	3	17	18	125	3	183
Gold in concentrate and doré	koz	399	122	92	280	358	2,905	101	4,257

Notes:

- The values in the table are subject to rounding.
- Concentrate produced is in dry metric tonnes.
- Havieron is 100% basis.

Annexure 1. Independent Expert's Report

Newcrest - Independent Technical Specialist's Report

Grant Samuel & Associates Pty Ltd

0223041

Table 3.12 AMC Production Case 2 – Telfer-Havieron cost schedule

Cost estimate	Units	FY24	FY25	FY26	FY27	FY28	FY29 to FY38	FY39 to FY48	Total
Operating Costs									
Mining	A\$M	393	76	142	298	386	2,894	72	4,261
Processing	A\$M	241	168	128	115	151	1,169	56	2,028
G&A, fixed	A\$M	100	106	156	83	84	798	34	1,361
Capital Expenditure									
Growth capital	A\$M	127	333	549	73	10	30	-	1,122
Sustaining capital	A\$M	84	17	79	134	94	412	18	838
Rehabilitation	A\$M	8	8	8	8	8	161	192	391

Note: Havieron is 100% basis.

3.11 Key risks and opportunities

3.11.1 Risks

In preparing the ITSR, AMC identified the following material risks:

- The longer-term plan for Telfer beyond FY26 relies on a number of underground ore sources, that combined provide up to approximately 4 Mtpa. Some of these ore sources are at an early stage of resource definition and with further increases in resource knowledge, may not provide the tonnes and grade estimates used in the Production Cases.
- The extent of underground infrastructure and equipment is unknown at this stage and may present a cost risk.
- The most recent Mine Closure Plan Stage 2 has not been accepted yet by DMIRS. This plan has significant changes to the proposed closure approach relative to earlier versions which could impact costs.

3.11.2 Opportunities

The region remains prospective for additional discoveries and the Telfer facility is ideally placed to process additional ore sources.

Havieron is currently at PFS level and further exploration success and study optimisation may improve the outcomes for this project.

Newcrest - Independent Technical Specialist's Report

Grant Samuel & Associates Pty Ltd

0223041

4 Lihir

4.1 Location and background

4.1.1 Location

Lihir is located on Lihir Island (also known as Aniolam Island) 900 km from Port Moresby, in the New Ireland Province, Papua New Guinea as shown in Figure 4.1. Lihir Island is a geothermally active extinct volcanic crater and is part of a volcanic island chain consisting of the Tabar, Lihir, Tanga, and Feni groups. Most travel by personnel to Lihir Island is by aircraft.

Figure 4.1 Lihir location

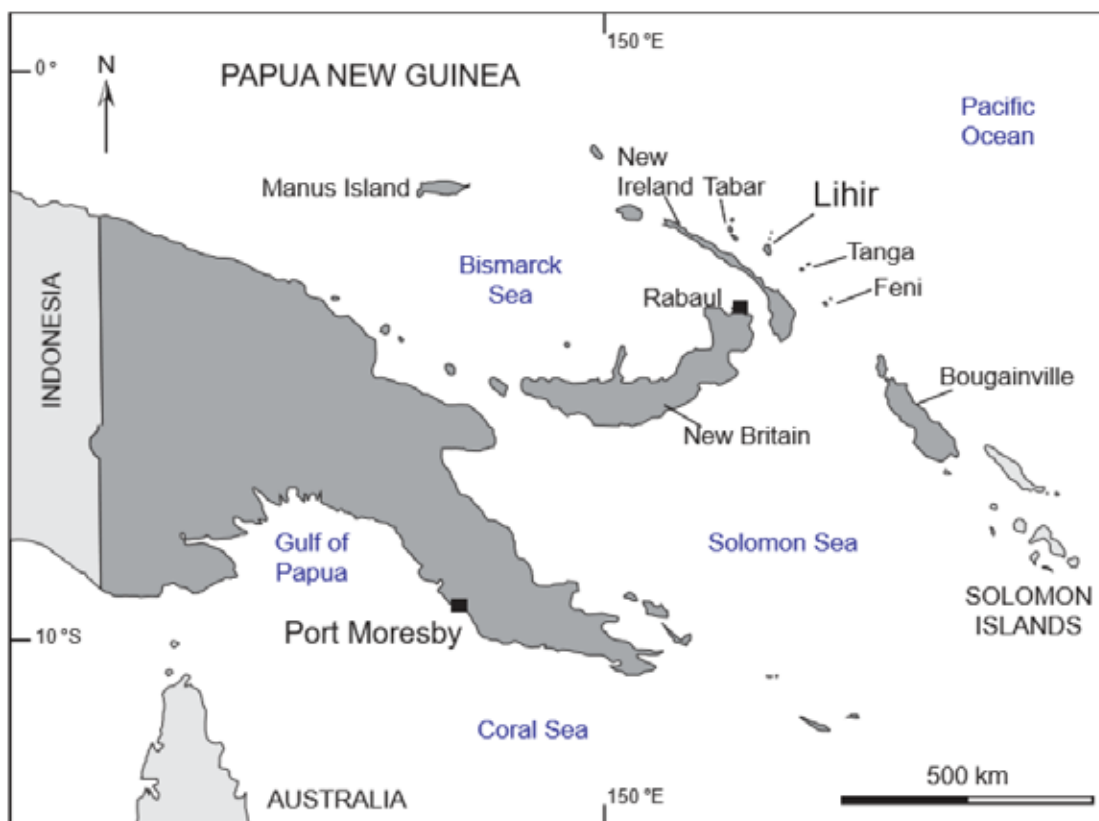

4.1.2 Background

The Lihir operation started in 1997. Newcrest acquired Lihir in 2010 and has operated the mine since. Under Newcrest ownership, plant capacity has increased to a nominal 15 Mtpa, although is yet to reach that capacity on a sustained basis. Production averaged 800 koz per year over the last eight years, with a stated target to reach a sustainable production level of 1 Moz of gold per year.

Open pit mining is mainly undertaken by a Newcrest owned and managed mining fleet with the majority of operators employed by Newcrest. Smaller mining contractors undertake pioneering and project work.

Mining uses conventional excavators and dump trucks. The majority of ore and waste is drilled and blasted. Uniquely, the ground is heated by geothermal steam increasing rock temperatures to over 160°C requiring special operating practices.

Newcrest - Independent Technical Specialist's Report

Grant Samuel & Associates Pty Ltd

0223041

The Lihir pit is designed to maintain the long-term integrity of the Alaiya Rock heritage site.

Historical pit design and mining activity adjacent to Alaiya Rock adopted conventional unsupported pit slopes. As a result, significant volumes of high and medium-grade ore (remnant ore) remain between the current pit walls and the edge of the approved mining boundary limit adjacent to Alaiya Rock.

Ore is trucked to stockpiles for blending to the processing plant. Waste is hauled to the port for discharge into 1,500 t barges which are used to dispose of the waste via offshore submarine disposal or to a harbour waste platform (HWP) fill area where waste is tipped and pushed to reclaim part of the harbour.

A seepage barrier will be constructed between the pit and the ocean in the Kapit area to prevent sea water ingress to the mine.

The Lihir ore is refractory. Ore is processed on site in a processing plant comprising crushing, grinding, floatation, and pressure oxidation followed by conventional leaching with cyanide of the oxidised slurry. Tailings disposed of by deep sea tailings placement (DSTP). Gold recoveries have typically been in the range 77% to 81%, with forecast recoveries used for the Ore Reserves of 73% to 85%.

Newcrest reports that:

- Having achieved an annualised 15 Mtpa sustainable processing plant throughput rate in 2019, Lihir has aimed at stabilising throughput at or close to this level with an increased focus on lifting recovery rates to maximise overall gold production and cash flow.

On-site power is generated using heavy fuel oil and supplemented by geothermal power. Processing water is a combination of sea water and freshwater from rainfall collection and drawing from the Londolovit River.

An accommodation centre is located at Put Put village with an airstrip at Kunaye. Approximately 4,800 people are employed at Lihir which has a combination of residential and fly-in-fly-out personnel. Around 90 per cent of employees are Papua New Guineans.

The mine is located within the caldera of the Luise volcano on the east side of the island. The caldera is geothermally active with dimensions of 4 km by 3.5 km as illustrated Figure 4.2.

Newcrest - Independent Technical Specialist's Report

Grant Samuel & Associates Pty Ltd

0223041

Figure 4.2 Lihir Island map

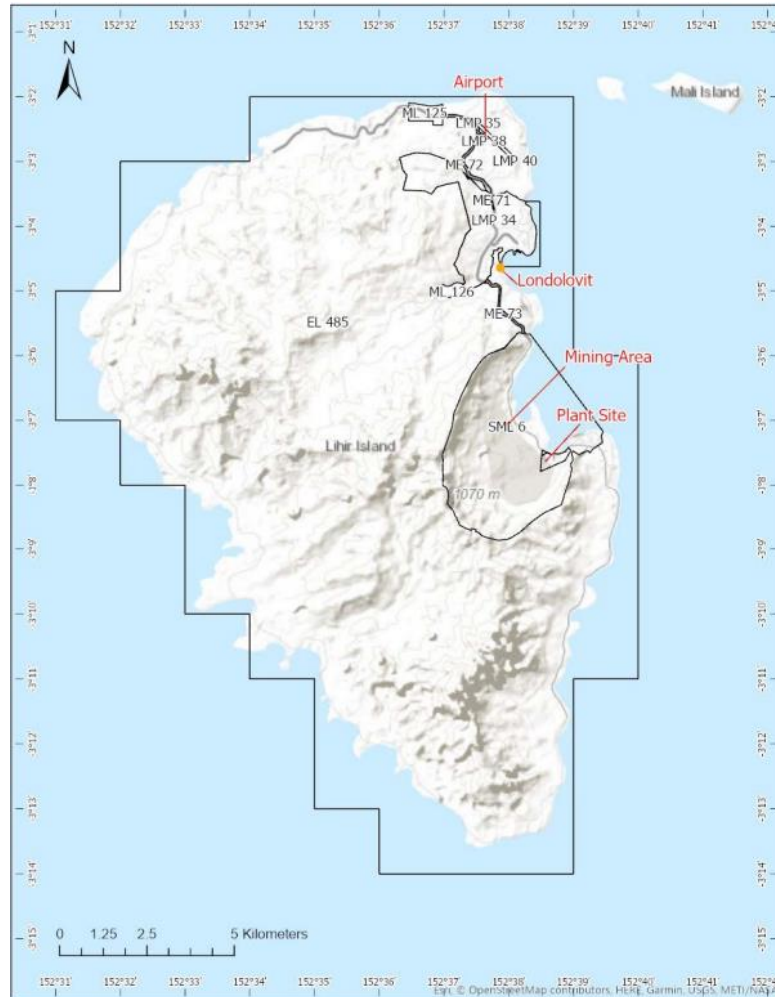

Recent enhancement studies include:

- The Phase 14A FS which describes mining phase 14A of the pit with steepened walls to reduce stripping.
- A Kapit pit seepage control concept study reviewing the design and implementation of a sea wall barrier for the Kapit area of the open pit.
- A processing recovery uplift study.

4.1.3 Tenement holdings

The operation is granted access via a special mining lease. In addition, the tenements include two MLs, one EL, five leases for mining purposes, and three leases for easements as listed in Table 4.1. The total lease area is 257 km².

Annexure 1. Independent Expert's Report

Newcrest - Independent Technical Specialist's Report

Grant Samuel & Associates Pty Ltd

0223041

Table 4.1 Lihir – material tenements

Tenement Number	Area (ha)	Tenement Type	Tenement Expiry Date	Status
EL485	21,000	Exploration Licence	31/03/2024	Current
LMP34	643	Lease for Mining Purpose	16/03/2035	Current
LMP35	34	Lease for Mining Purpose	16/03/2035	Current
LMP38	4.48	Lease for Mining Purpose	16/03/2035	Current
LMP39	0.2	Lease for Mining Purpose	16/03/2035	Current
LMP40	1.96	Lease for Mining Purpose	16/03/2035	Current
ME71	6.0	Mining Easement	16/03/2035	Current
ME72	21.2	Mining Easement	16/03/2035	Current
ME73	19.4	Mining Easement	16/03/2035	Current
ML125	48.2	Mining Lease	20/07/2025	Current
ML126	23.7	Mining Lease	20/07/2025	Current
SML6	1,739	Special Mining Lease	16/03/2035	Current

4.1.4 Operational history

The original feasibility study for Lihir was completed in 1992. The special mining lease was granted in 1995 and the first gold production was 1997. Mining commenced in the Minifie pit, expanding to the Lienetz pit in 2004. Studies are underway to expand the pit towards the harbour in the Kapit pit area.

Processing plant nominal capacity has increased from the initial 3 Mtpa to 6 Mtpa in 2008, 10 Mtpa in 2014 and a nominal capacity of 15 Mtpa in 2020. The maximum annual rate achieved was 14.2 Mt in 2018. Gold production has steadily increased from 0.5 Moz in 1998 to nearly 1Moz pa in 2018. Recent production levels have been lower due to various technical issues.

Table 4.2 Lihir historical mining and processing data

Year	Units	FY20	FY21	FY22	FY23
Ore mined	Mt	12.03	8.66	11.3	17.8
Total material mined	Mt	30.08	33.5	38.3	38.8
Total material moved	Mt	51.93	53.7	56.3	53.5
Gold grade mined	g/t	2.11	2.31	1.93	1.92
Ore processed	Mt	13.8	12.8	12.2	12.0
Gold feed grade	g/t	2.38	2.40	2.35	2.27
Gold recovery	%	74	75	75	76.5
Gold produced	koz	776	737	687	670

Source: Various monthly reports, Newcrest public documents and company advice

In FY23, mining volume is lower than budget and grade mined is lower than budget. Mining volume is 38.8 Mt (78% of budget). Processing tonnes are lower than budget resulting in less gold produced than budget (86%). Newcrest reported unplanned outages across all mills and also water shortages. In the open pit delays occurred in civil works in Phase 14A and poor shovel availability impacted production. Ore processed was 12.0 Mt.

In FY22, mining volumes were just below budget, ore processed was less than budget resulting in lower gold production than budget (92%). Newcrest reported this was due to unplanned outages, low autoclave availability and reduced water supply.

FY21 mining volumes were lower than budget, ore processed was lower than budget, gold grade processed was higher than budget resulting in lower gold production than budget (95%).



Newcrest - Independent Technical Specialist's Report

Grant Samuel & Associates Pty Ltd

0223041

Newcrest reported this was due to shutdown overruns and low autoclave availability. Mining was impacted by a roster change, slow mining in Phase 16 due to a wall failure, and low drill and barge availability.

In FY20, gold production was also lower than budget (776 koz versus 1,013 koz), Newcrest reported this was due to low autoclave availability. Total material mined was below budget, ore processed was below budget.

4.2 Site Visit

AMC undertook a site visit on 14 and 15 June 2023. Key aspects of processing and mining operational areas were visited and discussions were held with key technical services personnel.

4.3 Geology and Mineral Resource

4.3.1 Geology

Aniolam Island is part of a 250 km, northwest trending, alkaline rich volcanic island chain that has developed between the convergence zone of the Australian plate and the South Pacific plate. The Aniolam Island has developed several volcanic blocks on the island, and the Luise volcano hosts the Lihir deposit.

Lihir is an epithermal gold deposit hosted in a collapsed volcanic cone that has undergone post volcanic hydrothermal alteration, brecciation and gold deposition. The deposit is approximately 1,500 m by 3,000 m by 500 m deep, as indicated in Figure 4.3.

Newcrest - Independent Technical Specialist's Report

Grant Samuel & Associates Pty Ltd

0223041

Figure 4.3 Lihir geology and topography

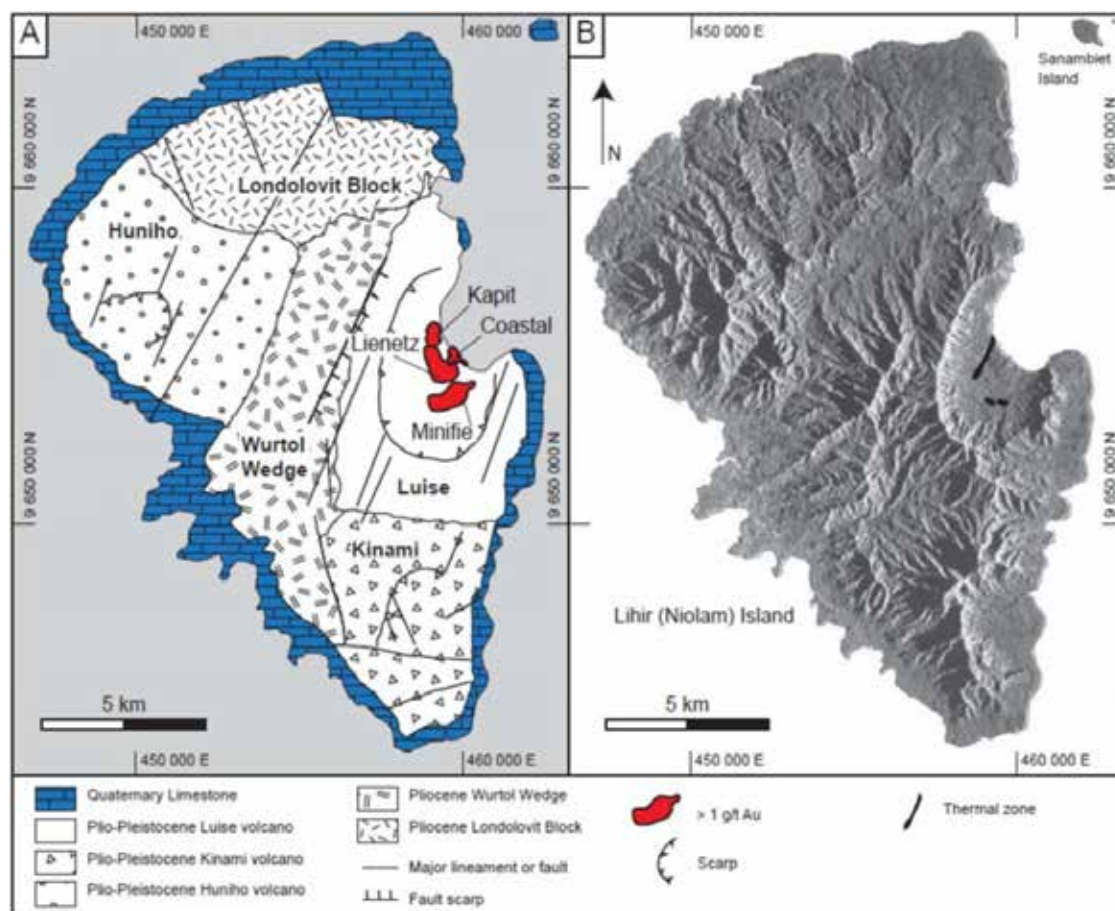

The gold typically occurs as refractory mineralisation within pyrite/arsenian pyrite mineral grains but is also present as native gold in quartz breccias, tellurides and as electrum. The gold is associated with three broad alteration zones within the Lihir deposit:

- 1 An argillic surficial clay alteration from modern steam activity results in generally barren material.
- 2 An epithermal high-grade (>3 g/t Au), refractory sulphide and adularia alteration zone that represents the ancient epithermal environment.
- 3 A porphyry, comparatively low-grade (<1 g/t Au) zone rich in anhydrite with or without carbonate, coupled with biotite alteration, that represents the ancient porphyry-style environment.

More recently, these broad zones have further been defined into nine sub-sets of alteration horizons shown below in Table 4.3.

Newcrest - Independent Technical Specialist's Report

Grant Samuel & Associates Pty Ltd

0223041

Table 4.3 Latest alteration sub-domains.

Original alteration	New sub-domained alteration
Argillic	Advanced argillic Argillic Intense argillic (upper argillic)
Epithermal	Upper epithermal Silica breccia Lower epithermal
Porphyry	Inner biotite Outer biotite Distal chlorite

4.3.2 Lihir Mineral Resources and estimation

The Lihir Mineral Resources estimate at 30 June 2023 at a 1.0 g/t Au cut-off are listed in Table 4.4.

Table 4.4 Lihir Mineral Resources as at 30 June 2023

Deposit and Classification	Tonnes Mt (Dry)	Grade Au (g/t)	Contained Metal Au (Moz)
Lihir Stockpiles (Measured)	57	1.9	3.5
Lihir Stockpiles (Indicated)	21	1.4	0.9
Lihir Open Pit (Indicated)	490	2.3	36
Lihir Open Pit (Inferred)	66	2.3	4.9

The Lihir resource model is based on information from 2,295 drillholes for 449,287 m of diamond core drilling. The core sizes are a mixture of NQ (47.6 mm), PQ (84.8 mm), and HQ (63.5 mm). The total number of drillholes within the database totals 3,703 for 721,105 m and the hole purposes include exploration, resource definition, metallurgical, and geotechnical and geothermal drilling.

The Lihir Mineral Resources estimate is evaluated above a conceptual open pit shell determined as having RPEEE. The Mineral Resource estimate is further evaluated on material within the pit shell above a marginal cut-off grade of 1.0 g/t Au.

4.3.3 Data collection

The majority of drilling is sub-vertical which intersects the horizontal mineralisation lenses at an optimal angle, where most mineralisation intercepts are near true widths. Typically, the drill spacings for the current resource definition are between 40 m to 100 m grid spacings with an average of 70 m. Drilling has been conducted over the full history of the development and operation of the site. Drilling locations by owner are shown in Figure 4.4. Drilling relevant to the current Mineral Resource were undertaken by Lihir Gold and Newcrest in different phases from 2000s to 2023. Most of the early drilling by Kennecott and Lihir Gold are now in mined out parts of the operations open pits.

Newcrest - Independent Technical Specialist's Report

Grant Samuel & Associates Pty Ltd

0223041

Figure 4.4 Mineral Resource drilling locations by owner

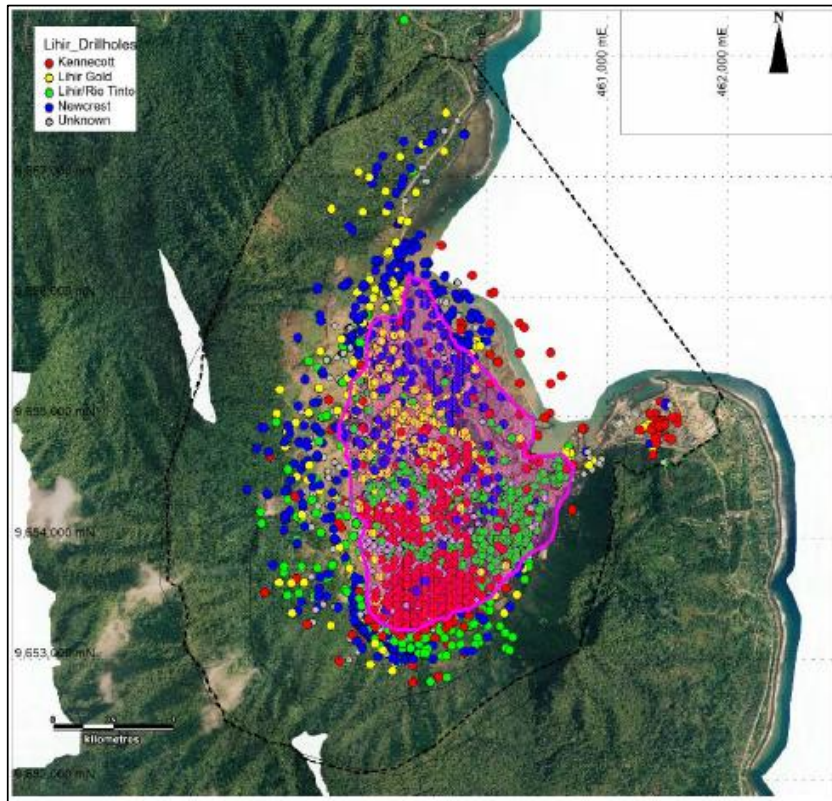

Reverse Circulation (RC) drilling occurs within the pit and long-term stockpiles for short term grade control models but are not used in the Mineral Resource estimate.

Generally, the recovery of core is greater than 99%, however there are faulted zones and clay rich zones that do exhibit poor recovery. The core is geologically logged, and the data is processed using acQuire software before being uploaded into a secure database onsite. All logging, preparation and sampling has been conducted on site at the Lihir Operations core processing facility since 1997.

Core is cut on site, dried (at 105°C), crushed and pulverised to 95% passing 106 µm pulverised grain size and then assayed at commercial laboratories in PNG and Australia. Samples are analysed for gold, copper, and sulphide sulphur. Gold utilises a 25 g charge for lead collection fire assay digest with AAS determination and sulphide sulphur is analysed using a standard LECO Corporation technique. Legacy sample preparation and assaying data is not available and was not recorded in the database but these are largely associated with mined out portions of the original resource.

Since 2010, check assays, metallurgical samples and multi-element assaying has been sent to laboratories such as SGS Brisbane, ALS Brisbane, or the Newcrest Services Laboratory in Orange.

Drillhole collars are surveyed using either theodolite or a differential global positioning system. The drillhole collars are surveyed in Lihir mine grid. Historic downhole survey methods included the use of historic Eastman film cameras or electronic single shot cameras. Gyroscopic survey methods are generally used on geotechnical drillholes. Not all drillholes have downhole surveys and some holes have large gaps between readings, however the typical range between survey readings is between 30 m to 50 m.

Newcrest - Independent Technical Specialist's Report

Grant Samuel & Associates Pty Ltd

0223041

4.3.4 Bulk density

Density determinations are measured on solid core using intervals approximately 10 cm in length. A geologist determines what core will be measured depending on alteration characteristics. The measurements are generally 50 m apart downhole. To determine the density, the diameter and length of the core are measured using a Vernier calliper. Subsequently, the selected interval is weighed on a balance.

4.3.5 Data management processing and checks

Data are stored in a SQL server database using acQuire software. Regular reviews of data quality are conducted by Lihir Operations site and Newcrest corporate teams prior to resource estimation, in addition to external reviews. The database is regularly backed up, and copies are stored in both offsite and in Newcrest facilities.

4.3.6 Data quality assurance and quality control (QA/QC)

4.3.6.1 Pre 2011

Newcrest has examined the pre-2011 QA/QC data and notes poor performance in a number of areas for QA/QC including with accuracy and precision of gold and sulphur analyses. All control measures used indicate that there were problems at the mine with sample mix-ups, swaps and mislabelling of control samples, and by inference, the routine drill samples. The subsequent examinations included large re-assay check assessments that indicated high variance between paired data, and indications of periods of a low gold bias of approximately -5% at the Lihir laboratory. The data for sulphide sulphur analysis suggests there was a systematic positive bias in the onsite laboratory performance for sulphur of the order of 15% to 20%. The positive bias is considered to be due to the degradation of the LabFit procedure over time such that it measured total sulphur rather than the sulphide sulphur the procedure was established for, and also the procedure used to generate the expected value of the CRMs. However, the sulphide sulphur assays are used for metallurgical characterisation and are not directly applied to Mineral Resource. AMC considers the poor QA/QC would not be likely to impact current Mineral Resource areas, as this data is dominantly for assays that support resources already mined out.

4.3.6.2 2012 to 2019

Since 2012 the Newcrest Resource Development QA/QC procedures involve submission and analysis of CRMs, blanks, duplicates, replicates, and grind and crush size checks. Monthly evaluation and reporting of QA/QC are undertaken. Analysis of gold, sulphide sulphur and carbonate at the site laboratory is reported to have no long-term material issues. Multi-element analysis from Newcrest Services Laboratory in Orange has indicated double the imprecision on pulp replicates of the onsite laboratory (8.4% versus 3.3% respectively) but is still within accepted Newcrest corporate standards (10%).

4.3.7 Mineral Resource estimation process

The Lihir geological interpretation is supported by core drilling, reverse circulation blast hole drilling, rotary drilling, in-pit mapping, and grade control drilling sampling data. Only core drillholes are used for the grade estimation.

Nine estimation domains are used in the estimation. Boundaries are tested using contact analyses, and are categorised as either hard, firm or soft. Compositing is on a 12 m basis with end of hole lengths retained. Top-cutting of extreme values is done on a domain-by-domain basis, limiting the influence of the top 1% of the grade distribution.

Variography is conducted on capped and declustering data. Variograms are calculated for gold, sulphide sulphur, arsenic, silver, calcium, carbonate, copper, and molybdenum. Gold variograms in real space are unobtainable; hence, Gaussian transforms are used for calculations and modelling. The Gaussian variogram models are back-transformed to real space for panel kriging

Newcrest - Independent Technical Specialist's Report

Grant Samuel & Associates Pty Ltd

0223041

and UC. The argillic domains generally had the lowest nuggets (5%, 17%, 15%), while the porphyries had the highest nuggets (23%, 40%, 31%).

4.3.8 Grade validation

Means of the declustered composites are compared with the means of the models by domain. The means were found to be acceptably similar. A NN declustering was performed in a 10 m by 10 by 12 m size grid. The NN, panel, and LUC models are restricted to a common volume, and means compared. The means of the panels, blocks and NN declustered comps are comparable. Grade-tonnage curves for all models were compared with grade-tonnage curves generated from the theoretical discrete Gaussian model change of support. No material flaws were noted.

4.3.9 Classification criteria

Mineral Resources were classified as either Indicated or Inferred Mineral Resources, based on a combination of the estimation slope of regression and the variogram-weighted distance. For Indicated Mineral Resources, a lower distance of 75 m was selected as the variogram-weighted distance. Inferred Mineral Resources are classified if within 160 m for the variogram-weighted distance.

4.3.10 Estimation summary

Gold and sulphide sulphur are estimated with the non-linear UC method into large 100 m by 100 m by 12 m panels in their respective domains. The panel UC grade-tonnage curve is subdivided into 20 m by 20 m by 12 m SMU blocks for the final output model. Minor elements (silver, copper, arsenic, carbonate, calcium, and molybdenum) are estimated directly into the SMU blocks using OK. Density is estimated using Ordinary Kriging into the nine geometallurgical domains.

4.3.11 AMC estimation validation

AMC has re-reported the Mineral Resource estimate and replicated the reported estimate. Reconciliation data is recorded and reported by mine operating systems. The high and medium grade ore control (blast hole supported) estimate versus the Mineral Resource estimate in FY23 shows a 2% increase in tonnes, a 10% decrease in gold grade for an 8% decrease in gold ounces. The current mining areas are in the bridge zone between the Lienetz pit and Kapit zone that is relatively poorly drilled compared to the main zones. Increase resource risk is therefore likely in this zone. AMC considers the overall Mineral Resource risk to be low.

4.3.12 Conclusions

Drilling, sampling, assaying and acquisition of other data used for estimation of the Mineral Resource have been collected following accepted industry practice and established protocols. Assay data used for grade estimation is supported by QA/QC procedures that follow accepted industry practice.

The Mineral Resource estimate is based on a geological interpretation that reflects the geological control on grade distribution.

The Lihir resource model used for the 2023 Mineral Resources estimate follows accepted industry practice and is appropriately classified as Measured, Indicated, and Inferred Mineral Resource in accordance with the JORC Code.

Swath plots of drillhole composites plotted against block model grades were reviewed and confirmed the model correlates with the input data in location and scale. The large stockpiles at Lihir are a risk from a material type and processing capacity point of view.

AMC confirmed reporting of the Mineral Resources estimate within the notional constraining shell.

Newcrest - Independent Technical Specialist's Report

Grant Samuel & Associates Pty Ltd

0223041

4.3.13 Exploration and resource potential

Significant mineralisation potential exists in the sub-sea portions of the historic caldera. Subject to reasonable prospects of extraction when mining mechanisms are formulated, these areas could form future Mineral Resource. Further grass roots targets have been identified on the island but are not prioritised for further development at this stage.

4.4 Geotechnical investigations

4.4.1 Lihir Geotechnical Management System

Lihir Deposit is situated in the footwall of the Luise volcano sector collapse detachment surface. From a geotechnical viewpoint this setting provides a unique combination of risks found in very few other deposits world-wide. These risks include severe geothermal conditions (steam pressures in the rock mass), very complex geology, potentially unstable caldera slopes above and surrounding the mine site, high seismicity, high rainfall, mining below sea level, potential for tsunamis and sea floor disposal of mine waste. The mine site is also spatially constrained. Consequently, Newcrest developed a very comprehensive Geotechnical Management System for all aspects of design as well as managing and monitoring operational mining in this setting.

Newcrest outlined its Geotechnical Management system for Lihir in its Slope Control Management Plan which describes both the design process as well as the operational management. Both these aspects have been reviewed at a high level in the context of current or planned mining in the follow sections and concludes with a short closing commentary.

4.4.2 Geotechnical Design Process

The documented Geotechnical Design Process involves data collection (logging mapping laboratory testing and acquire database updating), data reduction, modelling, updating of geotechnical models (rock mass and structural) as well as their slope design methodology and implementation. The design workflow follows the recommended industry approach published by Read and Stacey (2009) which has been tailored to the specific geotechnical risks present at Lihir Mine. While the initial data collection is undertaken on site, the actual life-of-mine designs are undertaken by the Brisbane based Lihir Development and Planning team assisted by external consultants as required. The feasibility studies and designs have a detailed peer review and signoff process.

AMC undertook a high-level geotechnical-related review on documentation provided for the following Lihir studies:

- Lihir 14A FS.
- Kapit Seepage Control CS2022.
- Kapit Extension – Preliminary Scoping Study.

4.4.3 Lihir Phase 14A Feasibility Study

The overall concept for the Phase 14A pushback is to develop a steep highwall adjacent to Alaiya Rock that is supported by a system of ground anchors that need to provide factors of safety that meets the design acceptance criteria for the slope as well as limiting displacements.

The study undertaken by independent consultants from 2021 to 2022 derives the anchor designs. Ten geotechnical drillholes were drilled in 2021 which were subsequently logged and sampled, and laboratory testing undertaken. Using this data, the consultants proceeded through a comprehensive design process covering updated characterisation of the Phase 14A rock mass, structural interpretation and kinematics, geotechnical domaining and updating geotechnical models and deriving design parameters. Hydrogeological and thermal characterisation was also undertaken. This was followed by slope assessments using 2D limit equilibrium models as well as 3D FLAC models (which are different methods of slope stability assessment) and then a rigorous design process for the ground anchors. Other associated design issues such as depressurisation, surface water management and monitoring were addressed.

Newcrest - Independent Technical Specialist's Report

Grant Samuel & Associates Pty Ltd

0223041

Field trials of the anchors have been implemented and results (such as pull-out tests) were detailed in the report. It should be noted that new types of monitoring instrumentation have also been recommended for the anchors. These include vibrating wire load cells and TDRs, VWPs and thermistors together with associated communication devices and data loggers.

The design has been externally reviewed and approved. While the study is noted as being at a FS level of confidence, the amount of detail and information provided in AMC's opinion qualifies the study as being at Implementation Level.

While the design of the Phase 14A wall steepening has been undertaken with a high degree of rigour the installation on site may be challenging and disruptive. Specialist civil contractors working around mining crews is likely to increase operational risk and slow mining rates.

New standard operating procedures (SOP) and response plans will have to be developed and consideration given to updating existing alarm and trigger thresholds particularly on the radar and prism networks which have been set up for conventional unsupported rock slopes only.

4.4.4 Near Shore Barrier

The Near Shore Barrier (NSB), subject of a pre-feasibility study, consists of a low hydraulic conductivity structural wall constructed through a nearshore environment of reclaimed land just west of the existing shoreline of the Inner Harbour. The low-permeability cut-off wall will be constructed using a conventional, well-understood civil engineering secant piling method. The barrier will be constructed with other associated works and monitoring systems.

The state objectives of the barrier are:

- "To reduce ocean and groundwater inflows through permeable mine waste rockfill and marine sediments into the pit.
- Facilitate vertical excavation of soft sediments on the pit side of the wall allowing the pit crest to be located as far east and as close to the wall as practical."

The barrier enables access to most of the Kapit orebody at reduced capital cost compared with alternative designs.

Newcrest notes that conventional and industry proven civil engineering piling methods is preferred for the design and construction of the barrier. The concept design study has been undertaken by a qualified external consultant, and a competent independent review team has reviewed the concept study.

It should however be noted that pit slope pore pressure modelling "has followed an empirical approach" in combination with a steady state model using "dewatered bore field" approach. Transient pore pressure modelling was planned but not undertaken for the study "due to geothermal complexity and modelling capability". The independent consultants have flagged that "if permeability is lower than expected, higher water levels may contribute to lower Factors of Safety".

The NSB is a significant undertaking requiring substantial temporary facilities and relocation of infrastructure and roads.

4.4.5 Kapit extension – preliminary scoping study

From a geotechnical perspective, the study leverages off steep wall engineering, advances in retaining wall engineering options, and advanced seepage barrier studies to identify opportunities for unlocking further mining inventory options in addition to the current mine plan. Again, the extent of reliance on steep wall slopes (with engineered wall support) and the effectiveness of the seepage barrier for this concept is unclear from this scoping document reviewed. However, it should be noted that the seepage barrier has not yet been constructed

Newcrest - Independent Technical Specialist's Report

Grant Samuel & Associates Pty Ltd

0223041

and the steepened walls section in Phase 14A has only relatively recently been implemented in a localised sector. Reliance on the effectiveness of these for larger scale and extended future mining operations should at this stage be limited until these systems have been proven to be effective and further operational experience gained.

4.4.6 Geotechnical Implementation and Operations

Considering the unique challenges and mining risks at Lihir, from an overall ground control management perspective, the Lihir operation appears to be relatively well managed. The geotechnical management systems and procedures that have been reviewed appear very comprehensive. The Geotechnical Department at Lihir has several monitoring systems, reporting and procedures that appear to be working relatively well. These include:

- An excellent Geohazard Management Plan.
- Excellent pit monitoring (radar and prisms).
- A high standard of inspections and geotechnical reporting.
- Slope reconciliation reports.
- Good record-keeping in the geotechnical GBIS database.
- Major risks and hazards have been identified and are generally well-controlled.

Generally, the controls are reasonable in terms of the SOPs reviewed by AMC but most are in need of updating (one of the SOPs that was reviewed was issued in 2015 and has not been updated).

Technical and operational reviews have taken place and deficiencies have been identified and agreed actions documented. Of note was the elevated risk of geothermal outburst (failed in two wells intersected in PH16 and PH17 slope failure). Both have led to business disruption. A further deficiency was the deviation of harbour waste platform to LOM sequence.

4.4.7 Closing Commentary

The geotechnical comments herein are based on information and reports provided for the purposes of preparing the ITSR.

The key geotechnical risks at Lihir are well documented and include:

- Hot geothermal environment with steam pressures in the rock mass.
- Mine site is located in an area of high seismic risk.
- Geology is complex.
- Mining below sea level.
- Groundwater and seepage are difficult to model (as observed by Newcrest).
- The pit is also surrounded by potentially unstable paleo landslides slopes of the caldera directly above the open pit.

From an assessment of available information, site inspections and pictures of the existing mine site it is reasonable to conclude that existing mining at Lihir mine has been undertaken successfully using relatively conventional mining methods and likely conservative pit wall designs where little to no ground support has been used. Few large-scale failures are evident.

However, from a geotechnical perspective, mining of Phase 30 and Phase 31 will rely on the implementation of an effective Seepage Barrier together with marginally steepened slopes whereas mining of Phase 14A will require the installation of anchor systems to ensure required pit wall stability. From a level of confidence viewpoint, the NSB Seepage Barrier is at a PFS level, and the steeped pit slopes have only recently started to be implemented for Phase 14A.

Newcrest - Independent Technical Specialist's Report

Grant Samuel & Associates Pty Ltd

0223041

This may well be able to be achieved in due course, however considerable further geotechnical and seepage modelling work will be required to confirm and prove designs and achieve required level of confidence.

4.5 Mining operations and Ore Reserves

The Lihir operation utilises conventional truck and shovel mining on 12 m high benches. Most material mined requires blasting. The primary mining fleet comprises 500 t class shovels and Caterpillar 785 (135 t) trucks. Newcrest is an owner operator. Final walls are pre-split to provide safe stable walls. Historically, up to 40 Mtpa has been mined with an additional 15 Mtpa to 20 Mtpa of stockpile movement and reclaim.

Historically, mining has been focused on the Minifie and Lienetz areas. Lihir is currently in the process of mining from Lienetz into the Saddle to gain access to the higher-grade Kapit area. The Kapit pit requires the most geothermal pre-draining. The Kapit pit will be developed by a series of cutbacks from south to north (refer to Figure 4.5 and Figure 4.6).

The Lihir pit is designed to maintain the long-term integrity of the Alaiya Rock heritage site.

Historical pit design and mining activity adjacent to Alaiya Rock adopted conventional unsupported pit slopes. As a result, significant volumes of high-grade and medium-grade ore (remnant ore) remain between the current pit walls and the edge of the approved mining boundary limit adjacent to Alaiya Rock.

With appropriate civil engineering and ground support techniques, steeper pit walls will be adopted, thereby enabling access to the remnant ore while ensuring an acceptable factor of safety for the pit slopes and Alaiya Rock. This assessment is the result of a feasibility study referred to as Phase 14A FS.

The current design for the ground support involves the installation of pit wall ground anchors (typically 60 m long on a spacing 3 m horizontal and 4m vertical), with face protection and face support (mesh, shotcrete/fibrecrete).

Long-term buttressing for Alaiya Rock will be provided by waste backfill in the Lienetz pit mined from subsequent mining phases.

Newcrest - Independent Technical Specialist's Report

Grant Samuel & Associates Pty Ltd

0223041

Figure 4.5 Lihir pit layout

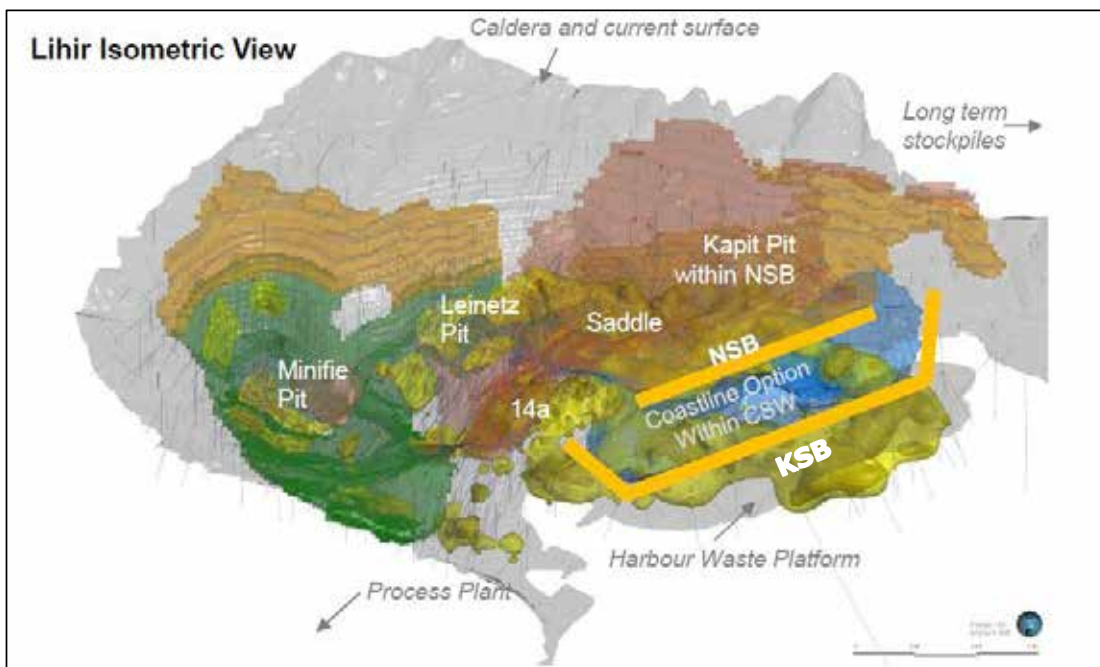

Figure 4.6 Lihir pit phases plan view



Newcrest - Independent Technical Specialist's Report

Grant Samuel & Associates Pty Ltd

0223041

4.5.1 Current mining operations

The key focus of the business is on operational performance in both mining and milling reliability and stability to improve asset utilization. This is required to achieve the ex-pit material movement rates required (approximately 55 Mtpa) for delivery of the business plan. Current operation is mining approximately 42 Mtpa, an improvement from 38 Mtpa in FY22. Newcrest developed an improvement project referred to as the Back to Basics (B2B) initiative. AMC considers the FY24 target of 55 Mtpa a significant stretch over existing performance.

The Phase 14A FS has been completed and is currently in execution. Civil wall steepening programme to access additional high-grade mineralization without impacting the pit crest (Alaiya Rock constraint). Phase 14A provides another approximately 0.4 Moz of incremental gold production over the next four years before production focusses on the Kapit pit.

Newcrest employs an elevated cut-off grade strategy, ROM feed is typically above 1.6 g/t Au, material between 1 g/t Au to 1.6 g/t Au is sent to long-term low-grade stockpiles and is treated at the end of mine life. Stockpiles provide backup ore supply and also enable the balancing of plant sulphur grades.

Existing surface stockpiles supplement mill feed.

The longer-term strategy is to develop more mining faces to enable more mining flexibility and ore blending opportunities.

The LOM mine schedules that support the Newcrest LOMP shows a logical progression of mining pit stages towards the Kapit pit. Pit stages present typical mining widths of 140 m to 200 m. Bench turnover analysis indicated that 8 to 10 benches are mining per year, this is considered consistent with industry practice. The need to address geothermal issues as mining progresses to deeper areas in the Kapit pit will likely challenge the bench turnover rate as it approaches 10 benches per year in some phases.

Newcrest provided an asset list for Lihir which comprised the following list of operational equipment:

- 10 production drills,
- 5 excavators (120 t to 250 t class)
- 5 face shovels (550 t to 600 t class)
- 39 Caterpillar 785 dump trucks (136 t payload)
- 5 Caterpillar 777 trucks (90 t payload)
- 17 dozers
- 5 graders
- Other support equipment

AMC notes that the actual ex-pit mining volume for FY23 is 38.8 Mt, which is 77% of budget for FY23).

Newcrest developed an improvement plan with the aim of improving loading and hauling productivity. The plan is intended to support the production of 55 Mtpa in FY24, FY25, and FY26. Based on discussion with site management and its own analysis, AMC formed the view that production levels ex-pit are more likely to be lower for these key years. The most challenging area is truck haulage.

Newcrest developed predictive model for pit ground temperatures. Higher temperatures are mitigated by deep drilling to relieve high temperature water and steam.

Newcrest - Independent Technical Specialist's Report

Grant Samuel & Associates Pty Ltd

0223041

Mining operations are made more difficult by the presence of the Argillic clays. It is noted over the LOM that the clays are declining as a percentage of material mined but are significant over the next 7 years.

4.5.2 Future mine expansion

Mining progresses towards the Kapit pit area over the LOM.

Construction of the NSB, is required for full extraction of the Kapit phases as included in the Newcrest LOMP. Phases 18 and 19 can be mined without the NSB, but Phase 30 and Phase 31 require it to be in place. The NSB is 900 m long, approximately 40 m deep and has an estimated capital cost of US\$411M. The NSB capital estimate is developed at pre-feasibility level. Timing of construction is commencing FY24 and finishing FY28. In AMC's opinion, this is a tight timeframe and likely to slip.

The capital estimate associated with the above NSB is shown in Table 4.5.

Table 4.5 Lihir NSB capital expenditure

Financial Year	Capital Expenditure (US\$M)
FY24	19
FY25	85
FY26	238
FY27	65
FY28	3

An alternative or addition to the NSB was also considered by Newcrest. This is the more substantial KSB which would be positioned further out in the harbour and is 1,900 m long. It has an estimated capital cost of US\$753M including US\$68M in contingency. The KSB, being further away from the Kapit pit allows mining of additional inventory, including pit Phase 35. Newcrest states that the NSB has a higher NPV and IRR over the KSB or the combined NSB and KSB option. Construction of the NSB was recommended as the outcome of the study.

4.5.3 Ore Reserves and estimation process

The Lihir Ore Reserves estimate at 30 June 2023 reported above a 1.0 g/t Au cut-off grade is summarized in Table 4.6.

Table 4.6 Lihir Ore Reserves as at 30 June 2023

Category	Tonnes Mt (Dry)	Grade Au (g/t)	Contained Metal Au (Moz)
Lihir Stockpiles (Proved)	57	1.9	3.5
Lihir Stockpiles (Probable)	26	1.3	1.0
Lihir Open Pit (Probable)	220	2.5	18

Notes:

- All data reported is on a 100% asset basis.
- Changes are aligned with the FY23 Life of Province Plan.

The Lihir Ore Reserve estimate is based on the resource model used to estimate the Lihir Mineral Resource which utilizes Localised Uniform Conditioning (LUC) to estimate block gold content. The LUC method allows for expected mining dilution and recovery to be built into the resource estimate based on the assumption of the selective mining unit (SMU) as the block size. An SMU of 20 m x 20 m x 12 m (X by Y by Z) was used based on the mining fleet configuration at Lihir. Due to the adopted LUC methodology for resource estimation, no additional mining dilution or recovery factors were applied to the Lihir Ore Reserve estimate. Newcrest states that this

Newcrest - Independent Technical Specialist's Report

Grant Samuel & Associates Pty Ltd

0223041

assumption is supported by actual reconciliation between the resource model and mill performance.

Ore control reconciliation results showed positive tonnage results were achieved in FY21 and FY22, with FY23 showing more typical reconciliation results.

Over the period reviewed, the reconciliation against the resource model appears reasonable with generally more tonnes of ore mined at a slightly lower grade than modelled.

Modifying factors and assumptions used for the Lihir Ore Reserve estimate were determined as part of a pre-feasibility study completed in 2020 and updated in 2023 based on operating experience and performance.

A marginal cut-off grade of 1.0 g/t Au was used to define ore and waste within the ultimate pit shell. The pit optimization allows economic contribution from Inferred Mineral Resources when determining the ultimate pit limits, however the Inferred Mineral Resources represents a small portion of the economic material within the pit design and is excluded as ore in both the Newcrest LOMP and Ore Reserve estimate.

The Lihir Ore Reserve estimate is based on the Phase14A FS study plant throughput rate of 14.2 Mtpa. The Ore Reserve is effectively all mined within the Newcrest LOMP.

AMC validated the stated Ore Reserve within the final pit as reported by Newcrest by importing the appropriate pit surfaces and block model.

4.5.4 Resource development and future mining concepts

A significant Mineral Resource sits outside the current open pit designs. Studies have been undertaken and will continue to be refined to evaluate the additional Mineral Resources including the previously mentioned KSB and CSW studies.

The remnant Mineral Resource comprises 340 Mt containing approximately 24 Moz gold. As studies progress some of that material is likely to be added to the business plan.

The Newcrest LOMP finishes in FY44. The additional inventory made accessible by the KSB and therefore the Kapit North extension (can potentially extend production to FY54. This would represent approximately 10 Moz in addition to the Newcrest LOMP.

Assessments are underway to determine the potential to apply civil wall steepening to other areas of the Lihir pit to access additional high-grade mineralisation.

4.6 Mineral processing

4.6.1 Processing plant description

The processing plant treats refractory ore and consists of crushing and grinding, flotation of part of the feed, pressure oxidation (POX), cyanidation of washed POX slurry, carbon adsorption, elution and recovery, electrowinning, and gold doré production. The nameplate capacity of the plant is 15 Mtpa, although it is yet to reach that level, having peaked at 14.2 Mt in 2018.

The flowsheet is presented in Figure 4.7 and Figure 4.8.

Newcrest - Independent Technical Specialist's Report

Grant Samuel & Associates Pty Ltd

0223041

Figure 4.7 Lihir processing plant flowsheet – grinding and flotation

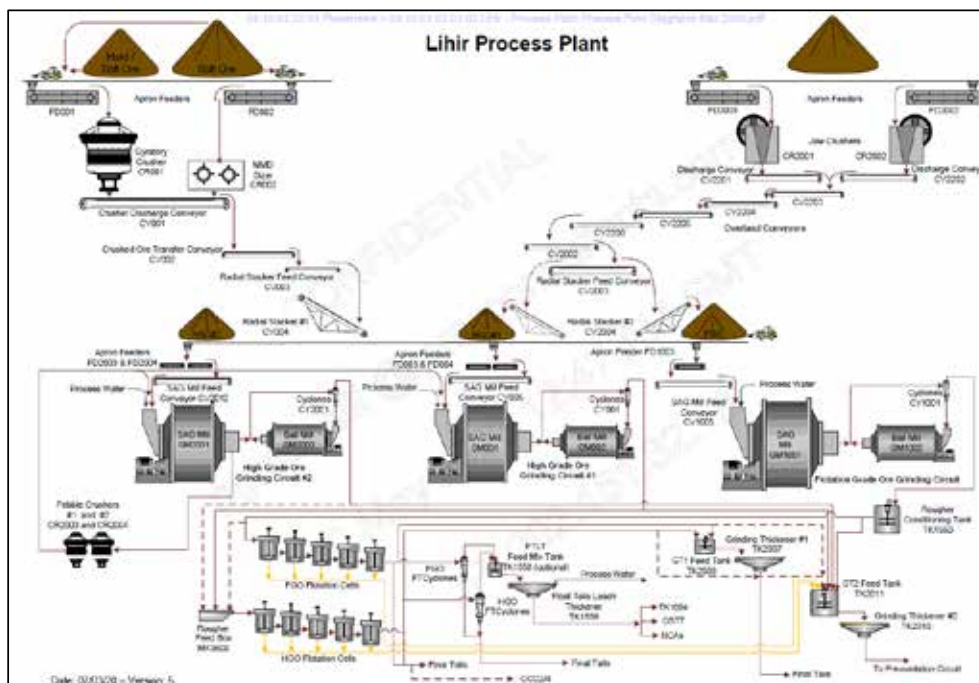
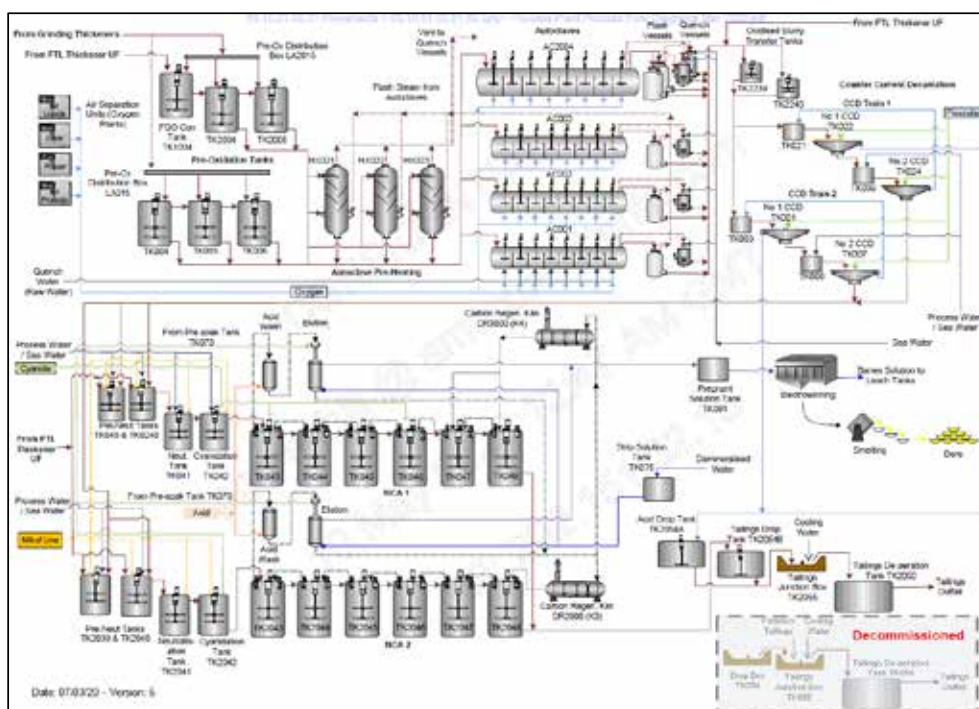

Figure 4.8 Lihir processing plant flowsheet – POX and NCA



Ore feed to the plant consists of several ore types present in the deposit. The main lithological types are epithermal, argillic and porphyry. The naturally fine grained ores (mainly argillic ores)

Annexure 1. Independent Expert's Report

Newcrest - Independent Technical Specialist's Report

Grant Samuel & Associates Pty Ltd

0223041

and clays affect both throughput and recovery. Wet and sticky ores present material handling difficulties which are managed by some blending and mechanical modifications to equipment to facilitate material flows. Once slurried, these ores can exhibit non-newtonian behaviour affecting slurry rheology. This can affect all process circuits. In general, the proportion of these ore types is limited to 20% to mitigate handling problems.

Milling capacity exceeds autoclave capacity and this is managed by varying the proportion of direct feed ore to the autoclave pre-oxidation tanks to ore feed to the flotation circuit. There are three parallel grinding circuits (SAG and ball mill) each of which can be directed either to flotation or to the autoclaves. Balancing the direct feed and flotation concentrate feed enables the matching of milling and autoclave capacity. The flotation circuit reduces mass flow to the autoclaves by rejecting the tails stream to a cyclone separation circuit that sends an undersize cut at $-40\mu\text{m}$ to the autoclave discharge tanks. Gold in this stream is recovered in the neutralisation, cyanidation, adsorption (NCA) circuit that processes the autoclave discharge.

The plant uses a strategy to maintain sulphide sulphur grade in the autoclave feed by varying the ratio of direct feed ore and flotation concentrate delivered to the pre-oxidation tanks. The slurry is passed to heat recovery vessels before pumping to the autoclaves. If sulphide sulphur content is high enough, pre-heating is unnecessary and is often practiced.

The autoclaves operate in a partial oxidation mode sufficient to achieve high gold recoveries. The discharge slurry is washed in a counter current decantation (CCD) circuit and neutralised with lime. The neutralised slurry is treated in a conventional carbon-in-leach (CIL) circuit with carbon adsorption and elution of gold. The gold solution is electrowon and the gold sludge is dried and smelted to produce gold doré.

Key reagent requirements are oxygen (generated on site via three cryogenic oxygen plants), cyanide, lime for neutralisation, flotation reagents (frother and collector) and grinding media.

4.6.2 Metal recovery

Lihir overall metal recovery has averaged 75% since July 2019. Recent (2022) recoveries have averaged 77.4%. See Figure 4.9.

Figure 4.9 Lihir recent gold recovery performance

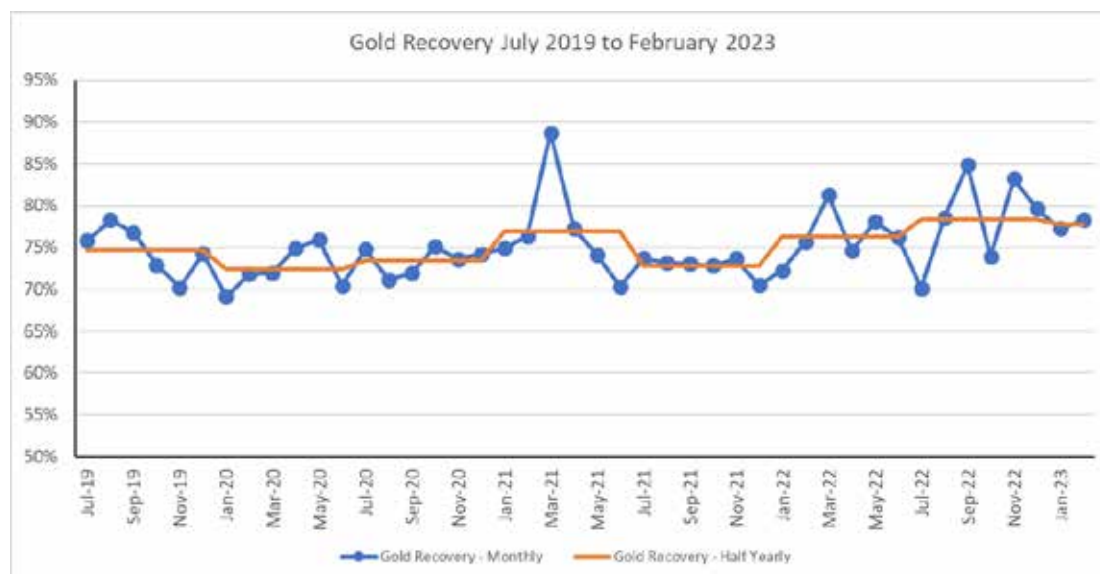

Newcrest - Independent Technical Specialist's Report

Grant Samuel & Associates Pty Ltd

0223041

4.6.3 Product transport and marketing

Three-year gold production and sales are shown in Table 4.7.

Table 4.7 Lihir historical gold production

	2020	2021	2022	2023
Production (oz)	775,978	737,082	687,445	670,013
Sales (oz)	760,724	773,146	665,993	674,080

4.6.4 Tailings storage

Tailings streams from the CIL circuit after detoxification and the flotation circuit tails are collected with CCD wash water, cooling water discharges and pumped to DSTP system. The stream flow discharges via a de-aeration tank to an outfall pipeline that exits at 125 m below sea level.

4.6.5 Future ore processing plans

Processing costs over the last five years have been in the range of US\$25/t to US\$39/t. Forecasts assume lower operating costs will result from improvement programmes instigated by Newcrest. AMC suggests that in the next 4 to 5 years, costs are likely to remain higher while consistent plant operational stability is achieved and sustaining investments become fully effective. The cost in the near term is likely to be in the order of US\$31.5/t.

Ore processing is planned to increase from the current 3-year average of 12.4 Mtpa, but varies from 13.03 Mtpa to a maximum of 14.65 Mtpa. The average forecast production over the LOM is 14.1 Mtpa, which is an increase of 13.7% over that for the last 3 years.

4.7 Site infrastructure and services

4.7.1 Power supply

Power is provided by a combination of heavy fuel oil (HFO) reciprocating engines and geothermal steam turbines to accommodate a total power demand of 115MW-126 MW (peak usage). Of this, 10 MW is provided by geothermal sources (constrained by declining steam availability), the remainder by HFO.

4.7.2 Water supply

Lihir uses a combination of seawater sourced from Luise Harbour, untreated and treated fresh water for its operations. Seawater is used for cooling three oxygen plants, the power station, quenching and scrubbing the pressure oxidation circuit, and in the post oxidation CCD circuit. Approximately 636,000m³/day of seawater is used in the plant.

Untreated fresh water is used in the milling circuits and grinding thickeners for washing the ore and control of ore chloride content. The approximate water consumption is 85,000 m³ per day. The fresh water supply is drawn from a small weir on the Londolovit River and pumped to the plant raw water storage tank. The raw water storage capacity is equivalent to approximately 6 days of operation necessitating a water conservation strategy that supports the operation during periods of low rainfall. Annual rainfall is in the order of 5m.

4.8 Environmental, Social, and Permitting

4.8.1 Environmental and regulatory approvals background

Under the Papua New Guinea (PNG) *Mining Act* 1992, there is one Special Purpose Lease (SML6) held for the project (approximately 523 ha) valid until March 2035, along with:

- Two granted Mining Leases (ML125, ML126).
- Five Leases for Mining Purposes (LMP34, LMP35, LMP38, LMP39, LMP40).
- Three Mining Easements (ME71, ME72, ME73).
- One Exploration Licence (EL485).

Annexure 1. Independent Expert's Report

Newcrest - Independent Technical Specialist's Report

Grant Samuel & Associates Pty Ltd

0223041

As a result, Lihir is located on a total land holding of 257 km². This land holding is mostly customary land, with some State-owned land and some privately held areas.

Newcrest also holds two Environmental Permits issued by the Conservation and Environment Protection Authority (CEPA) under the *Environment Act 2000* for water extraction and waste disposal. The permit for water extraction allows for the annual extraction of 59.6 Mm³ of water for processing, dust suppression, camp supply etc from 8 abstraction points. The permit for waste disposal allows for disposal of sewerage wastewater, tailings, waste rock, geothermal water, diverted freshwater and mine site dewatering into Luise Harbour from nine discharge points in varying quantities per year.

A Mining Development Contract (MDC) has been in place since March 1995 with the PNG Government (Mining Resources Authority, MRA). The MDC outlines project implementation as well as other aspects such as procurement, training requirements, royalties, and payments etc. Two EISs have been prepared for the project (in 2005 and 2009 for plant upgrades and million-ounce production upgrades).

Table 4.8 outlines the current primary approvals for the operation and their approval/expiry dates.

Table 4.8 Primary Approvals

Regulatory Authority	Details of Approval	Validity Date
CEPA	Environmental Permit for Water Discharge WD-L3(191)	1 Mar 1995 – 31 Dec 2045
CEPA	Environmental Permit for Water Extraction WE-L3(143)	1 Mar 1995 – 31 Dec 2045
Dept Mining & Petroleum (now MRA)	Mining Development Agreement	17 Mar 1995 onwards
Dept Mining & Petroleum (now MRA)	Approved Proposal for Development	1 Mar 1995 onwards
Dept of Justice & State Solicitor	Memorandum of Agreement (with National, Provincial and Local Government sectors)	2 May 2007
MRA	Memorial of Approval (Million Ounce Project Upgrade)	19 October 2012 onwards

The approved EIS contains the description of the operations and the management requirements for water supply, power and emissions, tailings disposal and general environmental and social aspects. AMC notes the following relating to the EIS and relevant approvals:

Water Supply and Management

The Lihir operations receive on average 4.4 m of annual rainfall, with extensive groundwater volumes, however Newcrest notes prolonged drought conditions can pose a risk to production, in part due to the terrain and seismicity of the island not being conducive to water storage. Additionally, seawater seepage into the pit from the adjacent Luise Harbour requires the construction of a seepage barrier wall between the pit and the harbour to reduce water inflow into the pit should Newcrest wish to realise greater access to the Kapit orebody. Diversion drains to manage freshwater runoff from rainfall into and around the pit are in place and pit dewatering via sumps and bores is extensive due to the proximity to Luise Harbour and mining below sea level. Lihir also has approval to abstract water from various river systems to provide process water (also supplemented to an extent by seawater), however water management at Lihir is an ongoing consideration as water is required for cooling the oxygen production plants and power station, as well as other aspects of processing and production. The approval of the Million Ounce Plant Upgrade project included the potential abstraction from the Wurtol River to supplement water supply for the operation.

Deep Sea Tailings Disposal

Lihir manages tailings using sub-sea methods (DSTP), AMC notes this method is used in several other sites nationally and internationally. Tailings are diluted with seawater and discharged via

Newcrest - Independent Technical Specialist's Report

Grant Samuel & Associates Pty Ltd

0223041

pipeline outfall at 125 m deep (below the surface mixing layer of the ocean – the productive zone of the upper ocean). Tailings gravitate down the steep submarine slope and are deposited on the sea floor 900 m–2,000 m deep. Water quality at the outfall zone and the mixing layer is subject to the requirements of the Environmental Permit conditions and is managed in accordance with the Environmental Management and Monitoring Plan (EMMP).

DSTP is the preferred disposal methodology for Newcrest from an environmental and social perspective as there is limited space for tailings impoundment due to terrain, and high rainfall and seismicity pose significant risk of tailings dam failure.

AMC notes that since 2010, there were no significant operational, compliance, environmental or social issues related to the DSTP. AMC is however not able to verify if this has continued as no information was available in the data room.

AMC also notes that placement of potentially acid forming waste rock and tailings in a submerged environment reduces the risk and impacts associated with acid mine drainage (AMD) and seepage from waste rock and tailings storage and disposal. AMC also notes that management of deposited tailings post closure will not incur additional management and maintenance requirements.

Acid and metalliferous drainage

The original environmental management plan for Lihir noted that much of the waste rock is either acid forming or PAF with only 0.6% of the expected waste rock NAF. Waste rock from the mine is either placed into 1,500 t capacity barges for offshore submarine disposal into Luise Harbour at a maximum rate of 30 million bench cubic metres per annum or tipped at the HWP or stockpiled for use in the operation (road base etc). Submarine waste disposal (approved under the Environmental Permit) is managed to achieve a continuous rill along the seafloor, minimising the potential for uncontrolled slumping.

As most waste rock (and low-grade ore) is potentially acid generating; submarine deposition keeps the rock saturated and reduces the risk of AMD (from waste rock). Additionally, AMD is generated from stockpiles awaiting processing, and management of runoff and seepage is required to ensure water quality criteria are met.

AMC notes the condition of the nearshore environment (fringing reefs adjacent to the operation) shows detectable impacts from waste rock disposal and surface run off (AMD), however the extent of this remains within the zones predicted in the original environmental management plan. Testing of low-grade ore and waste rock for AMD generating potential and associated management as required is included in the Lihir's environmental monitoring programme.

Energy and emissions

Power for the operation is provided by a combination of HFO reciprocating engines and geothermal steam turbines to accommodate a total power demand of 115MW-126 MW (peak usage). Of this, 10 MW is provided by geothermal sources (constrained by steam availability), the remainder by HFO AMC notes geothermal sources will decline in the medium term due to mining impacting the production wells, and Newcrest states that these will gradually be replaced by HFO sourced power. The Sustainability Report also notes greenhouse gas (GHG) emissions increased during the previous year (2021) due to maintenance on the geothermal power plant and power generation accounts for 77% of the emissions at Lihir.

In FY22, Newcrest stated that Lihir generated 726,957 tCO₂-e Scope 1 emissions (but no Scope 2 emissions), for a total emissions intensity of 60 kgCO₂-e/t ore milled. AMC notes this is significantly higher than Newcrest's other operations, and notes that the operation is hindered by Lihir's remote location, closeness to the equator, and constrained land mass. Decarbonisation options under consideration include emerging technologies, including low emission fuels,

Newcrest - Independent Technical Specialist's Report

Grant Samuel & Associates Pty Ltd

0223041

processing efficiencies, and carbon offsetting. AMC notes that Newcrest has set a target of 30% reduction in Scope 1 and Scope 2 GHG emissions intensity per tonne of ore milled by 2030.

Cultural heritage and social aspects

Cultural heritage studies of the project area were conducted as part of the project baseline in 1989 through 2010. A total of 45 cultural heritage sites of significance have been recorded during the 1989 study and since that time. Of these, 24 are located on Lihir, and the others on different islands within the group.

A series of Lihir Customary Land Use Agreements has been developed commencing with the 1995 Integrated Benefits Package (IBP), an extensive Review of the IBP in 2007 and then the negotiation of the current suite of Landholder Agreements which concluded in December 2020. The latter are between Newcrest and tenement holders and family groups, and the full suite of Agreements addresses a complex series of landowner compensation and benefits amongst other provisions. The Agreements were then registered by the PNG Registrar of Tenements in April 2021 in fulfilment of a key requirement of the Mining Act. These agreements are confidential, and this is common practice in all regions of the world.

Newcrest is committed to sustainable development and has in place a Communities Policy, Environmental Policy, Human Rights Policy, Sustainability Policy, Indigenous Relations, the Lihir Community and Environment Policy, Lihir Sustainable Development Plan, and Social Impact Monitoring Program (ongoing), the Lihir Cultural Heritage Management Plan, and the Lihir Ailaya Management Plan.

Newcrest also supports the maintenance and preservation of cultural heritage through the re-establishment of the Lihir Cultural Heritage Committee, which recognises the importance and uniqueness of Lihirian cultures the local culture and its preservation for further generations. This includes funding for clans to manage and maintain existing cultural heritage sites within the mine footprint. The Million Ounce Plant Upgrade project approval also resulted in the establishment of a Lihirian Cultural Centre as a base for programmes and activities to support social outcomes.

Biodiversity

Baseline studies were completed between 1988-1992 prior to commencement of the project and identified several marsupials, avifauna, bats, reptiles, and mammals present in the area, no species of conservation significance were recorded. A number of small freshwater fish species were noted to be present in the streams and rivers, as well as one species of nesting sea turtle [unidentified] on the beaches in the island group. Fringing coral reefs were not extensive around the island, and few live corals grew within the shallow water which mainly contained seaweed. Small patch reefs occur in Luise Harbour but had limited diversity and showed signs of sediment damage from nearby creek flood plumes.

AMC notes that as mining and operations have occurred since the grant of the SML in 1995, the biodiversity and environment currently present within the mining area is largely modified since the original biodiversity surveys, and the most recent EIS available for review does not describe the remaining biodiversity in detail.

AMC further notes a regulatory-approved EMMP is used to manage and monitor the predicted environmental impacts from the project and is updated and reviewed every four years and endorsed by CEPA.

Compliance and Regulatory Reporting

Newcrest submits an Environmental Performance Report to CEPA each year describing the outcomes of the environmental management and monitoring applicable to each of the two Environmental Permits and as described in Lihir's EMMP. Newcrest also maintains a central

Newcrest - Independent Technical Specialist's Report

Grant Samuel & Associates Pty Ltd

0223041

compliance system for the site to report environmental incidents, notifications, investigations, action tracking and reporting and inspection requirements.

Additionally, the EMMP describes the requirements for weekly reporting of water abstraction volumes for WE-L3(143) Condition 12, quarterly reporting of water data under Condition 13 of WE-L3(143).

A companywide Annual Sustainability Report is also prepared each year detailing the environmental, social and governance matters progressed each year, however AMC notes this is not a statutory requirement.

4.8.2 Future approvals

While the majority of approvals are in place, additional permits will be required for the construction of the seepage barrier (although previously approved the 2005 EIS, still requires signoff by the MRA). Additional approval from CEPA and amendment to the Environmental Permits are likely to be required for the addition of further HFO power generation infrastructure to replace geothermal power, and AMC notes that as of 2020, Newcrest states that this has commenced. Should the project wish to make amendments to the processing infrastructure (for example, tertiary grinding and flotation capacity, etc) or changes to AMD management and/or waste rock management, this is also likely to require additional regulatory approvals.

Newcrest states that an application was made to CEPA and MRA in February 2023 for a new lease for mining purposes to host an extension of the existing marine waste rock dump. The extension will provide sufficient capacity to support mine waste disposal. Approval of the marine waste rock dump extension is planned for the end FY25.

4.8.3 Rehabilitation and closure planning

Rehabilitation

As the site has been operational since the late 1990's previous rehabilitation activities were focused on stabilisation of the Minifie and Lienetz pit walls, with some areas of direct planting and hand seeding occurring on a campaign basis around stockpile areas, however no substantial rehabilitation activities have occurred since. AMC notes a total of 218 ha out of the 2,156 ha of disturbed area has been rehabilitated, the remainder will need to be addressed at mine closure and the Mine Closure Plan states progressive rehabilitation will be investigated during operations.

Closure Plan

The project has an expected mine life of up to 30 years and has had a conceptual closure plan in place since 1995. The plan is updated and refined in accordance with the Newcrest Closure Standard, with the most recent revision in 2019-20 updated in 2023. The PNG legislation requires a detailed Mine Rehabilitation and Closure Plan to be submitted to the regulator a minimum of two years prior to cessation of operations.

The key components of the current plan include the closure obligations and objectives, the data available, identification of closure management issues, knowledge gaps and risk assessment; as well as general implementation and post closure monitoring.

AMC notes closure will occur in three stages – pit closure, end of milling operations and post closure monitoring. Site rehabilitation and closure will include decommissioning and removal of infrastructure not intended for community use and remediation of disturbed areas. It is expected that the pit will be opened to the sea and flooded to form a bay, and the HWP) will be excavated to below sea level to form a shallow bay area. Rehabilitation and closure of the waste rock and tailings deposition area will not require works other than removal of onshore infrastructure and remediation of disturbed land.

Newcrest - Independent Technical Specialist's Report

Grant Samuel & Associates Pty Ltd

0223041

AMC notes a project bond was listed as held with the MRA, however it is unknown at the time of writing whether the introduction of the Mining Project Rehabilitation and Closure Guidelines proposed for introduction by the MRA in 2019 has affected this bond.

Closure Cost Estimates

An independent consultant completed a Closure Cost Estimate (CCE) in 2020, which updated the previous versions and included social costs and employee severance as well as closure management considerations (previously excluded in prior versions). The CCE estimated a significant life-of-mine closure cost, along with additional costs for monitoring, contaminated site management, contingency, social and severance costs (including 12 years of post-closure management and monitoring) at a level generally in keeping with what could be anticipated for a mine of this scale. AMC notes the closure costs are somewhat reduced by the absence of significant waste landforms to rehabilitate and close as well as the use of DSTP, which significantly reduces the costs associated with closure of tailings facilities.

AMC also notes that increases in the CCE compared to previous versions are partly due to proposed changes to closure of the HWP, sections of which will now be removed to below sea level post closure to prevent AMD and stability issues upon closure and consideration of flooding of the pit at the end of mine life. Additionally, AMC notes Newcrest has developed and contributes annually to a Mine Closure Investment Fund to cater for the social aspects of mine closure, and that a social baseline and closure impacts study is required to further identify and refine the social cost of closure on the communities associated with mine.

4.8.4 Conclusions

Lihir is a large, well-established mine, with an expected environmental and social impact generally in keeping with a project of this scale and long mine life. While the operation has significant production, the project benefits from a relatively reduced environmental management and rehabilitation regime, as the use of DSTP and submarine disposal of waste rock offsets the need for construction of large, potentially unstable (given the terrain, climate, and seismicity of the area) storage facilities.

While there appear to be no significant existing environmental, social, or compliance related issues that cannot be managed within the existing Environmental Management System framework; the project's future GHG emissions are notable and substantial. AMC notes that Newcrest has committed to net zero carbon emissions by 2050 and is assessing future power options for Lihir. Geothermal power is currently used at Lihir to provide a small proportion of power for the site. Lihir is analysing alternative low carbon options to supplement power supplies. An example of short to medium term options under consideration include systems to provide greater efficiency of the current fossil fuel powered generators, and/or progressively swapping the generators to run on lower emission fuels. A range of longer term power supply options are also under consideration including new and emerging technologies. While the remote location and limiting terrain of the island is somewhat challenging, AMC notes there are likely to be challenges for Newcrest meeting its proposed carbon emissions targets without further consideration of alternative power sources.

Newcrest - Independent Technical Specialist's Report

Grant Samuel & Associates Pty Ltd

0223041

4.9 Operating Costs

Historical operating costs for Lihir are summarised in Table 4.9. Unit costs for mining, processing, and G&A are shown in Table 4.10.

Table 4.9 Lihir historical operating costs

Operating Costs	Units	FY21	FY22	FY23
Mining	US\$M	188	235	282
Processing	US\$M	400	395	447
Engineering	US\$M	8	2.8	5.7
G&A	US\$M	222	213	229
TCs/RCs and penalties	US\$M	2.4	1.9	2.0
Royalty	US\$M	35	31	31

Source: Various Newcrest reports, public documents, and company advice.

Table 4.10 Lihir historical unit operating costs

Activity	Units	FY21	FY22	FY23
Mining	US\$/t mined	5.60	6.14	7.25
Total material moved	US\$/t moved	3.49	4.18	5.26
Processing	US\$/t ore milled	31.28	32.31	37.33
G&A	US\$/t ore milled	19.71	19.07	19.62

FY23 unit costs are aligned with the budget.

FY22 unit mining costs were higher than budget (+38%), \$/t moved (+30%) other costs were aligned to budget. Higher mining costs were attributed to Phase 14A activities and general labour cost increases with some impact from higher travel costs.

FY21 unit processing costs were over-budget (+16%), G&A unit costs were over-budget (+20%), other costs were aligned to budget. Cost increases were attributed to plant failures shutdown overruns and other costs associated with the impact of Covid-19. Site costs were generally above budget in FY20.

4.10 AMC production cases

Newcrest provided AMC with a LOM production and cost schedule (Newcrest LOMP) for Lihir together with supporting information. The schedules are presented on an annual basis.

Based on the information provided by Newcrest, discussions with Newcrest personnel, and observations made during AMC's site visit, AMC developed two production cases:

- AMC Production Case 1 is based on the Newcrest LOMP physicals and reflects AMC's adjustments to the processing plant throughput rates, and mining, processing, and G&A operating costs, and an adjustment to the LOM metallurgical recovery estimates. Processing is scheduled to FY47.
- AMC Production Case 2 is similar to AMC Production Case 1 but reflects higher plant throughputs and lower operating costs over the LOM.

4.10.1 AMC Production Case 1

The Newcrest LOMP shows production of an average 1.08 Moz gold over the next 10-year period. In AMC Production Case 1, processing plant throughput is reduced in line with historical performance for the first 4 years of the case, and then the ore processing rate is limited to a maximum of 13 Mtpa thereafter. The lower processing throughput requires less ore from the mine offsetting potential mine productivity issues. Therefore, after the reduced processing plant

Annexure 1. Independent Expert's Report

Newcrest - Independent Technical Specialist's Report

Grant Samuel & Associates Pty Ltd

0223041

throughput was applied, no further production reductions to either ore mined or grade milled were applied.

In AMC Production Case 1, gold recoveries are reduced to align with AMC's assessment of historical averages and recent metallurgical modelling by Newcrest. The net impact is to reduce recovery by 3% in the first 4 years and then by 1.5% for the remainder of the LOM relative to the Newcrest LOMP. Total gold production over this period is therefore lower than the Newcrest LOMP.

AMC notes that the actual mine operating costs over the last 3 years averaged US\$6.33/t mined or approximately 50% higher than the Newcrest LOMP average. These historical mining costs represent increases due to lower productivity, the impact of Covid-19, higher waste volume handled by barge, costs overrun for Phase 14A wall steepening, and generally difficult mining conditions.

Similarly, processing operating costs have been approximately 30% higher than the Newcrest LOMP average, and G&A operating costs have been typically 40% higher than a typical year in the Newcrest LOMP.

In developing AMC Production Case 1, AMC has reflected some of the same cost pressures observed in the last three to four-year period. In AMC Production Case 1, AMC increased the operating costs presented in the Newcrest LOMP by approximately 16% as an allowance for what AMC expects will be an impact of a continuation of the cost pressures.

Mine closure costs were increased to align with the 2020 consultant's report.

AMC increased the mining sustaining costs presented in the Newcrest LOMP by approximately US\$15M per year during FY26 to FY33 of this AMC production case to reflect ongoing replacement of the large mining fleet. AMC considered that processing plant sustaining costs are adequate and were not changed from the Newcrest LOMP.

A summary of AMC Production Case 1 is presented in Table 4.11 and Table 4.12.

Table 4.11 AMC Production Case 1 – Lihir production schedule

Estimate	Units	FY24	FY25	FY26	FY27	FY28	FY29 to FY38	FY39 to FY48	Total
Total material mined	Mt	55.0	55.0	55.0	48.9	49.1	284	45	593
Ore mined	Mt	15.6	14.5	21.4	18.0	18.7	119	19	226
Gold grade	g/t	2.20	2.19	2.53	2.76	2.87	2.20	2.02	2.37
Ore milled	Mt	12.4	12.3	12.5	12.5	13.0	130	110	303
Gold feed grade	g/t	2.53	2.36	3.18	3.27	3.55	2.33	1.63	2.21
Gold recovery	%	77	77	77	77	80	82	80	80
Gold Produced	koz	780	718	987	1,022	1,190	7,937	4,622	17,256

Note: The values in the table are subject to rounding.

Newcrest - Independent Technical Specialist's Report

Grant Samuel & Associates Pty Ltd

0223041

Table 4.12 AMC Production Case 1 – Lihir cost schedule

Cost Estimate	Units	FY24	FY25	FY26	FY27	FY28	FY29 to FY38	FY39 to FY48	FY49 to FY58	Total
Operating costs										
Mining	US\$M	325	277	287	237	257	1,797	579	-	3,759
Processing	US\$M	388	386	391	392	393	3,695	2,908	-	8,552
G&A	US\$M	175	175	175	175	175	1,750	1,425	-	4,050
Capital Expenditure										
Growth capital	US\$M	97	175	295	97	3	18	-	-	685
Sustaining capital	US\$M	347	278	196	208	217	1,199	300	-	2,745
Rehabilitation	US\$M	-	-	-	-	-	-	116	242	358

4.10.2 AMC Production Case 2

AMC Production Case 2 is based on the AMC Production Case 1 with the following adjustments:

- Processing plant throughput was reduced for only the first 4 years of the case. Thereafter, the processing plant throughput rate is broadly aligned with the Newcrest LOMP, and peaks at 14.7 Mtpa.
- The processing recovery adjustment is the same as AMC Production Case 1.
- Operating costs are increased for the first 5 years of the case then return to those in the Newcrest LOMP reflecting the expected improvement in operating conditions.

A summary of AMC Production Case 2 is included Table 4.13 and Table 4.14.

Table 4.13 AMC Production Case 2 – Lihir production schedule

Estimate	Units	FY24	FY25	FY26	FY27	FY28	FY29 to FY38	FY39 to FY48	Total
Total material mined	Mt	55.0	55.0	55.0	48.9	49.1	284	45	593
Ore mined	Mt	15.6	14.5	21.4	18.0	18.7	119	19	226
Gold grade	g/t	2.20	2.19	2.53	2.76	2.87	2.20	2.02	2.37
Ore milled	Mt	12.4	12.3	12.5	12.5	13.1	142	98	303
Gold feed grade	g/t	2.53	2.36	3.18	3.27	3.55	2.33	1.08	2.21
Gold recovery	%	77	77	77	77	80	82	80	80
Gold Produced	koz	780	718	987	1,022	1,203	8,634	3,912	17,256

Note: The values in the table are subject to rounding.

Table 4.14 AMC Production Case 2 - Lihir cost schedule

Cost estimate	Units	FY24	FY25	FY26	FY27	FY28	FY29 to FY38	FY39 to FY48	Total
Operating Costs									
Mining	US\$M	325	277	287	237	257	1,562	497	3,442
Processing	US\$M	388	386	391	392	361	3,670	2,368	7,955
G&A	US\$M	166	157	183	174	173	1,460	983	3,296
Capital Expenditure									
Growth capital	US\$M	97	175	295	97	3	18	-	685
Sustaining capital	US\$M	347	278	196	208	217	1,199	200	2,645
Rehabilitation	US\$M	-	-	-	-	-	-	176	358

Newcrest - Independent Technical Specialist's Report

Grant Samuel & Associates Pty Ltd

0223041

In AMC's opinion, the AMC production cases presented for Lihir represent probable range of outcomes for the future of the business. AMC believes there are reasonable grounds to support both outcomes.

4.11 Key risks and opportunities

4.11.1 Risks

Phase 14A wall steepening - Newcrest reports that the wall steepening has a factor of safety of 1.5 which is not high by civil standards. There is always a level of uncertainty with complex geotechnical design. There are also risks associated with maintaining the quality of the anchors and shotcrete functions. Risk mitigation includes the level of investigation, external reviews of the design and after installation detailed radar and load cell monitoring of the wall.

The NSB is a complex construction project. Studies to date are at PFS level. There are significant risks associated with the completion schedule and effectiveness of such a construction. Ground conditions are currently, not well understood. Detailed design and quality of installation reduce these risks.

The operation is conducted in a seismically active area and mining is conducted at elevations below sea level which poses a risk of earthquake, tsunami and landslide events, historic events which have been recorded in the area.

The Lihir processing plant is a complex operation that requires sophisticated operational planning and execution. Autoclave capacity constrains overall throughput as the refractory gold bearing minerals require oxidation of sulphide hosts to release gold for recovery in the NCA circuit. The feed blend optimisation targets sulphide sulphur content by balancing ore feed to the flotation circuit and high-grade ore fed directly (after milling) to the pre-oxidation slurry tanks. Variation of sulphur grades impacts autoclave temperature control and the potential for accelerated wear of refractory liners and failure (as seen in 2022). High quality management and operational practices are required to achieve the forecast processing plant throughput which are key to operational cash flow.

The different ore types are currently being fed from the ROM pad to the processing plant (with the exception of low-grade ore that is stockpiled for future processing) without blending to reduce the natural variation of grade and mineralogy. The feed variability increases the difficulty of managing the sulphide sulphur content in the autoclave.

The proportion of fine ore feeds (mainly argillic ores) and clays present material handling difficulties that lead to increased downtime and maintenance requirements, negatively impacting reliability. This results in variable and decreased ore throughput.

Fresh water usage is approximately 85% of the permitted draw from the Londolivit River and storage capacity is sufficient for 6 days of operation. Periods of low rainfall may cause production limitations. Water security due to potential drought conditions pose a material risk to plant operations, as the area is not conducive to large water storage features, and the operation's water demand can only be partially supplemented by seawater. Newcrest is currently investigating alternative water supply options.

Equipment degradation due to the local environmental conditions and high tonnage usage is a reliability and downtime risk. The failure of critical equipment such as conveyors, fixed plant infrastructure and civils will cause restriction or loss of production. Maintenance planning and execution is a critical performance indicator.

Project closure is a complex exercise with costs and timing at risk of increasing in scope and duration.



Newcrest - Independent Technical Specialist's Report

Grant Samuel & Associates Pty Ltd

0223041

High fossil fuel consumption to generate power has a risk of higher price inflation over the short and medium term.

4.11.2 Opportunities

Significant pit expansion beyond that projected in the Newcrest LOMP is probable via the use of the KSB and CSW (refer section 4.5.2 of this ITSR), thereby enabling longer mine life and higher gold production.

Mining costs are relatively high at Lihir. However, there are ongoing efforts to improve mine efficiency and place additional waste at the harbour backfill site which present opportunities to reduce operating costs over the LOM.

AMC notes that mine and processing plant performance has often fallen below budget in recent years and has reflected some of those costs and performance metrics in its production cases. However, efforts to maintain consistent ore supply and achieve higher plant utilisation present opportunities to improve aspects of the overall performance thus increasing production, gold recovery, and potentially reducing operating costs.

5 Red Chris

5.1 Location and background

5.1.1 Location

Red Chris is a joint venture between Newcrest (70%) and Imperial Metals Corporation (30%). It is located on the northern edge of the Skeena Mountains in north-western British Columbia, Canada. It is 18 km southeast of the town of Iskut, 80 km south of Dease Lake, and 1,700 km from Vancouver as shown in Figure 5.1.

Figure 5.1 Red Chris location

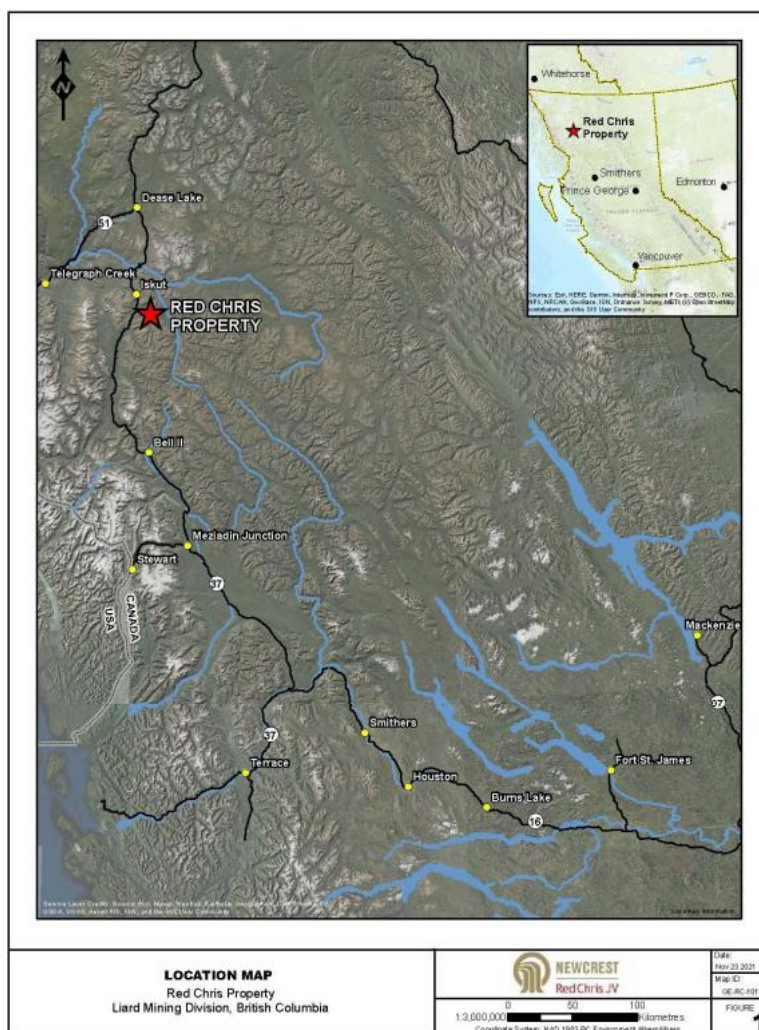

5.1.2 Background

Red Chris is a copper gold mine that commenced construction in mid-2012 and operations in February 2015. Newcrest acquired 70% of Red Chris in August 2019 from Imperial Metals Corporation and operates the mine. The Newcrest LOMP shows production to Year 2043.

Newcrest - Independent Technical Specialist's Report

Grant Samuel & Associates Pty Ltd

0223041

Red Chris is comprised of:

- One open pit mine comprised of two zones (East and Main).
- An underground mine that is in development stages. A box-cut and decline external to the pit have been developed. The East orebody is planned to be developed using the block caving mining method.
- WRD adjacent to the open pit.
- Ore processing facility that operates at 38,000 tpd to produce concentrate using standard industry flotation methods.
- The TSF is a valley fill tailings impoundment area (TIA).
- Other supporting infrastructure including accommodation camp, offices, warehouses, shops, and sediment and water management infrastructure.
- Power transmission line that runs from Bob Quinn to Tatogga and then to the mine.
- Red Chris Access Road that runs 23 km from Highway 37. The transmission line and Access Road are located within a single corridor.

Concentrate is trucked from Red Chris to the Port of Stewart via Highway 37.

5.1.3 Tenement holdings

Red Chris tenure comprises five MLs and 199 mineral claims. The material tenements are the five ML, as listed in Table 5.1, along with a right of way tenure for part of the power transmission line.

Infrastructure located outside of the Mining Lease areas is authorised by the British Columbia *Land Act* via 16 Licences of Occupation. A portion of the Brucejack Access Road (72 km from the intersection with Highway 37 until it reaches the Mining Lease boundary) is authorised by a Special Use Permit under the *Forest Practices Code of British Columbia*. Details of these permits are provided in Table 5.2.

Table 5.1 Red Chris key land tenure and authorisations

Tenement Number	Area (ha)	Tenement Type	Tenement Expiry Date	Status
999362	691	Mining Lease	20/06/2023	Renewal pending
999363	573	Mining Lease	20/06/2023	Renewal pending
999364	546	Mining Lease	20/06/2023	Renewal pending
999365	1,254	Mining Lease	20/06/2023	Renewal pending
999382	2,077	Mining Lease	20/06/2023	Renewal pending
6408389	68.95 for part of transmission line	Right of Way Tenure	14/07/2024	Current

Annexure 1. Independent Expert's Report

Newcrest - Independent Technical Specialist's Report

Grant Samuel & Associates Pty Ltd

0223041

5.1.4 Operational history

Table 5.2 Red Chris historical mining and processing data (reported on 100% basis)

Year	Units	FY21	FY22	FY23
Ore mined	Mt	8.7	7.9	8.0
Total material mined	Mt	34.1	35.0	31.1
Total material moved	Mt	40.2	41.7	38.8
Gold grade mined	g/t	0.43	0.37	0.39
Copper grade mined	%	0.47	0.45	0.40
Ore processed	Mt	9.6	9.3	9.3
Gold feed grade	g/t	0.39	0.35	0.36
Gold recovery	%	53.8	57.2	52.3
Gold produced	koz	66	60	56
Copper produced	kt	33	30.5	26.1

Source: Various monthly reports, Newcrest public documents and company advice

5.2 Site Visit

During AMC's site visit, key aspects of the operation were inspected including the open pit and underground workings, the processing plant, the core handling and storage area, and the TSF. Discussions were also held with senior members of the Red Chris operating team.

5.3 Geology and Mineral Resources

5.3.1 Geology

Red Chris is a copper-gold-molybdenum deposit that has undergone several phases of alteration and mineralisation, located in the Stikinia island-arc terrane of northern British Columbia. The Stikinia terrane is dominated by island arc volcanic, sedimentary, and plutonic rocks of the Middle to Late Triassic Stuhini Group, and the Early to Middle Jurassic Hazelton Group. The arc assemblages overlie a basement of Late Paleozoic rocks known as the Stikine Assemblage comprised of sedimentary rocks and submarine volcanics.

The Stuhini and Hazelton assemblages were formed in island arcs due to easterly (and possibly westerly) directed subduction. Much of the Stikinia Group is overlain by clastic sedimentary rocks and minor volcanics of the Bowser Basin, characterized by chert-clast rich sandstones and conglomerates eroded from the Cache Creek Group, located to the east of Red Chris.

The Red Chris deposit is hosted within an elongated, east-north-east trending, porphyritic, intrusion, called the Red Stock, that intruded the Stuhini Group. The Red Stock zone, the primary zone of mineralisation, is >2 km long (WSW-ESE) and up to 650 m wide and is comprised of a series of porphyry intrusives.

Newcrest - Independent Technical Specialist's Report

Grant Samuel & Associates Pty Ltd

0223041

Figure 5.2 Geology map of Red Chris

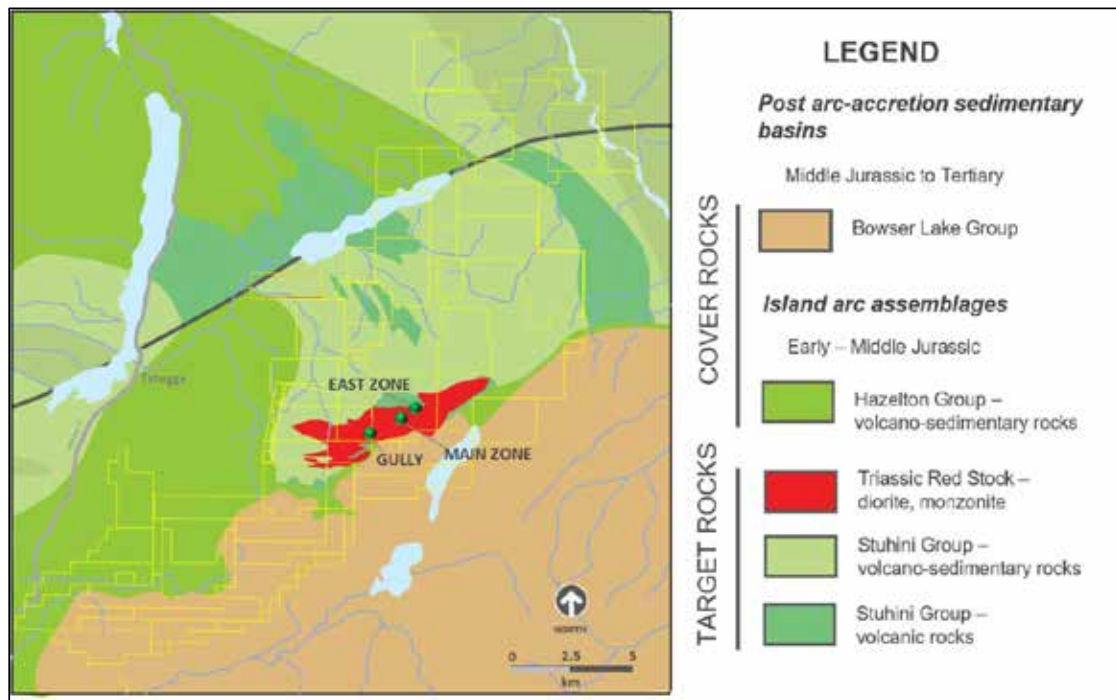

Mineralisation in the Red Chris deposit comprises of copper mineralisation, as sulphides (primarily chalcopyrite) hosted in quartz veins as well as disseminated mineralisation contained within the porphyries. In the upperpart of the Red Chris deposit, bornite-rich mineralisation was overprinted by a later stage sericite and clay alteration events.

Gold, in the Red Chris deposit, mainly occurs as microscopic inclusions in the copper sulphides. Free gold is occasionally observed in high-grade zones.

Molybdenite is locally associated with quartz veining, with its frequency of occurrence increasing with depth, and in lower grade areas of the Red Chris deposit.

Several significant faults cut the Red Stock, that have controlled subsequent mineralisation and alteration trends.

5.3.2 Mineral Resources and estimation

The current Red Chris Mineral Resources estimates for open pit and underground, as provided by Newcrest are declared as at 30 June 2023. The estimates are reported for Red Chris Open Pit and Red Chris Underground in Table 5.3. It should be noted that the East Ridge Exploration Target has not been reported as a Mineral Resource. Drilling within the East Ridge Exploration Target has confirmed the continuity of the mineralisation across the vertical extent of the deposit.

The Red Chris Mineral Resources estimate, prepared in 2023, is based on 487 DD holes, totalling 287,534 m of drillcore. This includes an additional 47 DD holes, comprising 38, 139 m of drilling which were added to the data base since September 2020.

The cut-off grade for the Red Chris Mineral Resources estimate is based on a NSR of CAD\$17.70/t for open pit and CAD\$21.0/t for underground to demonstrate RPEEE as referred to in the JORC Code. The base of the open pit is approximately 360 m below pit crest.

Annexure 1. Independent Expert's Report

Newcrest - Independent Technical Specialist's Report

Grant Samuel & Associates Pty Ltd

0223041

Table 5.3 Red Chris Mineral Resources as at 30 June 2023

Classification	Tonnes Mt (Dry)	Grade		Contained Metal	
		Au (g/t)	Cu (%)	Au (Moz)	Cu (Mt)
Open Pit Stockpiles - Measured	8.6	0.17	0.25	0.048	0.021
Open Pit - Indicated	220	0.31	0.37	2.2	0.82
Open Pit - Inferred	7.6	0.26	0.31	0.065	0.024
Underground - Indicated	670	0.46	0.40	10	2.7
Underground - Inferred	180	0.32	0.30	1.8	0.54

Note: All data reported is on a 100% asset basis, Newcrest attributable share is 70%.

AMC notes that:

- Tonnages are estimated and reported on a dry tonnage basis.
- The Mineral Resource estimate does not account for mining recovery or mining dilution.
- Mineral Resources are inclusive of the Ore Reserves.

The Mineral Resource estimation processes used for open pit and underground are the same.

5.3.3 Data collection

All drillholes used in the Mineral Resource estimate are DD, with core sizes ranging from PQ, HQ, NQ and BQ. All core was drilled from surface. Following logging, the core is cut in half using an automatic core cutter, with one half being retained for reference purposes and the second half submitted for assay purposes.

Holes drilled on Red Chris are oriented either on 3 m or 6 m runs using a Reflex ACT III tool. Historical core was not oriented and was mostly drilled vertically. Newcrest report that DD recoveries are typically 100%, with isolated zones of lower recovery.

Recognized commercial testing laboratories are used for assaying samples using industry-accepted assay methods with acceptable detection limits. Newcrest samples were assayed for 59 elements using four acid digestion followed by ICP-ES/ICP-MS determination. Gold analyses were determined by 50 g fire assay with ICP-ES finish.

Historical assays were undertaken at various ISO 9001 certified laboratories in Vancouver. All samples were analysed for copper by ICP-ES or AA with aqua regia digest.

Newcrest has reviewed historical quality control data and has imported the data into the acQuire data base.

Historical drill collar locations were surveyed using either a total station instrument, a survey quality GPS or a handheld Garman GPS. Downhole surveys were undertaken at 9 m interval using various Reflex survey methods. All collar co-ordinates are in the North American Datum system (NAD83 Zone 9).

Newcrest collar positions are surveyed using a RTK GPS GNSS with a stated accuracy of +/- 0.025m. Downhole surveys are completed at 9 m to 30m intervals using a Reflex EZ-SHOT tool.

5.3.4 Bulk density

Bulk density determinations are undertaken at 100 m downhole intervals, by the onsite geologist or geological assistant using the Archimedes, water displacement method.

Newcrest - Independent Technical Specialist's Report

Grant Samuel & Associates Pty Ltd

0223041

Intervals for bulk density determination are selected according to lithology, alteration or mineralisation type. Currently over 7, 311 density measurements are available in the Red Chris data base.

Bulk density estimation in the Mineral Resource estimate is undertaken using inverse distance interpolation methodology.

5.3.5 Data management

All diamond drill core is logged and photographed by the geology team prior to cutting. Half core is sampled at 2 m intervals. Logging is captured digitally using Toughbook computers, directly into an Acquire logging system stored electronically in an acquire site database, which is maintained by the Database Supervisor. This database is backed up automatically to a central Melbourne Head-office database.

During the site visit AMC observed that the core handling and storage facility was well kept and equipped. No core preparation, logging or sampling was being conducted during the site visit, and therefore the procedures were not able to be directly observed. However, the method of sample selection and preparation for assay, as documented and described to AMC by on site geological staff, are rigorous and consistent with current accepted industry standards.

5.3.6 Data management processing and checks

Data is manually checked for errors and gaps and where issues are noted, these are corrected before the data is imported to acquire database and internal validation reports are used to confirm that the data is robust.

All data is then reviewed spatially in Leapfrog™ and Vulcan™ software to confirm that it is correctly located. During the estimation process data is validated within geological domains, with exploratory statistical analysis being undertaken on the data to confirm elemental correlations as well as the presence of any anomalous assay values and/or incorrect geological coding that may require rectification.

5.3.7 Data quality assurance and quality control (QA/QC)

Data QA/QC procedures have been applied since exploration commenced on the Red Chris deposit in 1968 (all historical data has subsequently been converted to metric).

Newmont reviewed the historic QA/QC data for Cu and Au and concluded the data was fit for use for an MRE and have included the associated data in the master data base for use in Mineral Resource estimation.

Two laboratories are currently used by Red Chris – an onsite laboratory is used for grade control purposes, with Bureau Veritas Vancouver used to assay samples from the resource development and exploration programmes.

Current Newcrest QA/QC protocols require the insertion of certified reference material, blanks, field duplicates, pulp duplicates, and coarse duplicate assays.

The frequency of QA/QC assaying (19.1% of primary assays) currently exceeds Newcrest's planned compliance of 17.5% of the primary assays. Blanks are inserted at a nominal 1:40 rate (2.5% of primary assays).

AMC has reviewed the QA/QC reports provided and is satisfied that the assay results used for Mineral Resource estimation are fit for purpose.

Newcrest - Independent Technical Specialist's Report

Grant Samuel & Associates Pty Ltd

0223041

5.3.8 Mineral Resource estimation process

The Mineral Resource estimation process followed is the same for Red Chris open pit and underground.

The following domains are modelled by Newcrest for Red Chris (refer Figure 5.3):

- Four main geological units (Bowser, Redstock Intrusive, Stuhini Sediments, and Stuhini Volcanics).
- An alteration model.
- A mineralisation model.

Figure 5.3 Red Chris lithological model - East Zone (Section 27N)

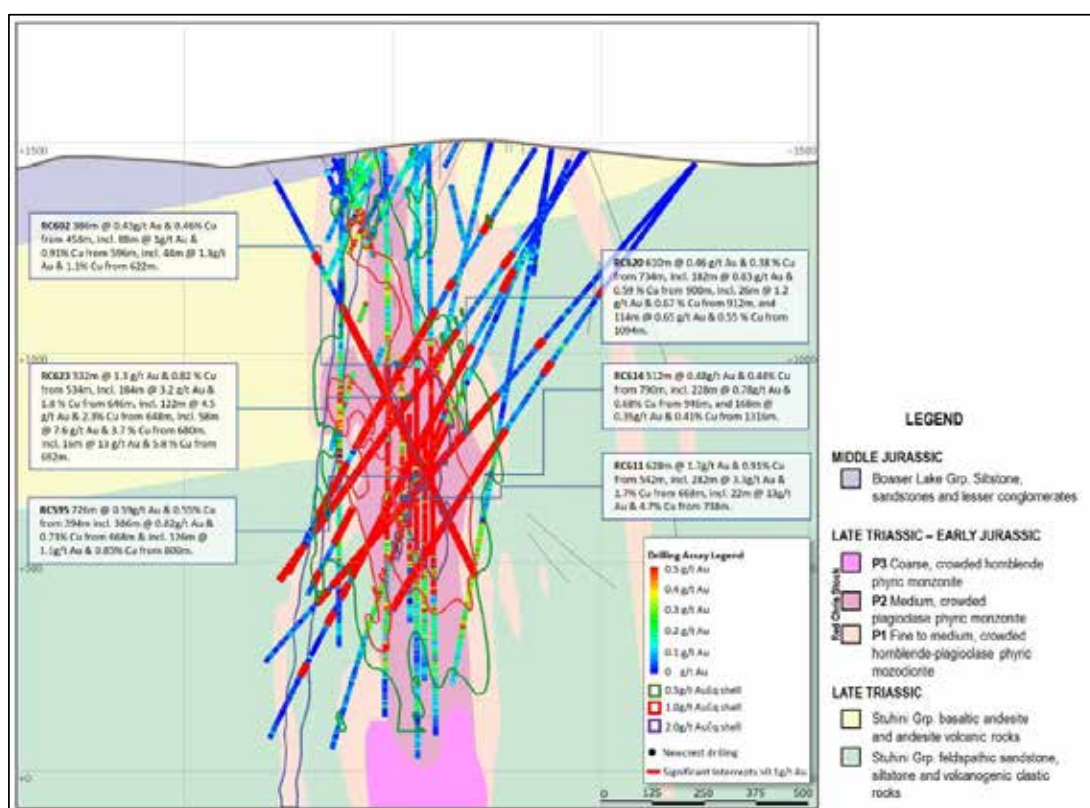

Source: Red Chris Technical Report

Wireframes for the domains are constructed using Leapfrog™ software, with the resulting wireframes being imported into Maptek Vulcan™, initial coding of the DD data is undertaken using Minesight™ software, Newcrest staff then reviewed the coding for accuracy and consistency. Samples are composited to 12 m lengths, also using Minesight™ software. The composite length is a function of the SMU vertical dimension (12 m). The composite length honours lithological contacts, Newcrest also confirms that the amount of metal lost due to the compositing methodology used is negligible, that is, residuals are discarded during the compositing exercise. Statistical analysis and variography is undertaken using the composited data, assay values are not capped during the estimation process. The impact of extreme values is dealt with via a search distance restriction.

Contact analysis is undertaken on the defined domains, resulting in the use of hard domains for lithological contacts and soft contacts being used for the Redstock subdomains.

Newcrest - Independent Technical Specialist's Report

Grant Samuel & Associates Pty Ltd

0223041

Experimental semivariograms are calculated and modelled using Isatis™ (2018). Semivariogram modelling for the Redstock domain was undertaken using Gaussian transformed data, the semivariograms for all other domains were calculated and modelled in real space. Where appropriate, experimental, and cross variograms for strongly correlated data were also generated (that is, Fe-S, and Ca-Mg). KNA is used to determine minimum and maximum sample numbers, block sizes, and searches for estimation purposes. The estimation neighbourhood testwork was carried out for Cu and Au using Snowden Supervisor TM.

Localised Uniform Conditioning is used to estimate the Redstock domain using a panel size of 80mE x 80 m N x 12mRL, with a localised SMU of 20 mE x 20 mN x 12 mRL for Cu, Au, Fe, S, Ca, and Mg estimation. OK is used to estimate Ag, As, Sb, Hg, and C directly into the SMU for Redstock domain. OK is used to directly estimate all elements into an SMU size of 20 mE x 20 mN x 12 mRL. The same panel and SMU sizes are used for both open pit and underground Mineral Resource estimation.

Density is estimated into the SMU using Inverse Distance to the power of three.

AMC considers that the estimation approach used is reasonable.

5.3.9 Grade validation

Following estimation, the estimate is validated using the following methodologies:

- Visual validation of block grades against drillholes.
- Statistical comparisons between grade and block data.
- Swath plots of drillhole data and block models.
- Comparison between the LUC estimates to the Discrete Gaussian Modelling of the Global Change of Support values for Cu and Au.
- Metal comparison between the Panel and SMU estimates.
- Comparison with the previous estimate.

A monthly reconciliation report is published for the Red Chris open pit operation, reconciling mining planned and actuals as well as the planned metal grade feed to the metallurgical plant and actual recovered grades.

FY23 showed the ore tonnes mined were 8.5% above plan, with gold grade being 26% higher than plan. This is the result of additional gold ounces (additional to the Mineral Resource estimate) being identified by ore control when mining the bridge zone.

Red Chris has provided a detailed action plan in the reconciliation report outlining the actions that are that are planned to correct the current deviation from plan.

AMC is of the opinion that the estimation process used to estimate the Red Chris Mineral Resource is fit for purpose.

5.3.10 Classification criteria

The Red Chris Mineral Resources estimate is classified and reported as Measured, Indicated, and Inferred in accordance with the JORC Code as follows:

Measured:

Mined and stockpiled material is classified as Measured. In situ material has not been classified as Measured.

Indicated:

An Indicated classification is allocated when the weighted distance of informing data is less than 100 m and the estimate has a slope of regression of >0.7.

Newcrest - Independent Technical Specialist's Report

Grant Samuel & Associates Pty Ltd

0223041

Inferred:

An Inferred classification is allocated when weighted distance of informing data is less than 175m and the estimate has a slope of regression of >0.4 .

AMC considers the approach taken by Newcrest for classification of the Red Chris Mineral Resources estimate to be reasonable.

5.3.11 Estimation summary

AMC makes the following observations:

- The interpretation and domaining is based on geology and grade data that have been gathered and validated using currently accepted industry practice.
- The geological interpretation and modelling of the mineralised lithologies has been approached in a systematic manner, with regular review stages to ensure that the interpretation is robust.
- Grade estimation uses accepted industry practices.

Grade valuation procedures are in line with accepted industry practices.

5.3.12 AMC estimation validation

AMC has independently reviewed the resource model estimations as a global confirmation of grade for the Red Chris estimates of open pit and underground Mineral Resources, using data supplied by Newcrest. AMC replicated the Mineral Resources estimates reported by Newcrest, allowing for rounding by Newcrest and the use of different software packages.

AMC viewed the drillholes against the block model and satisfied itself that the distribution of geology and grade is represented by the block model.

5.3.13 Conclusions

AMC's conclusions for the Mineral Resources estimate are:

- AMC considers that the Red Chris Mineral Resources estimate classifications, given the complexity of the geology as being reasonable.
- The estimates are appropriately classified as Indicated and Inferred Resources in accordance with the JORC Code. AMC agrees with the Red Chris Mineral Resources estimate classification.
- AMC has used the resource models provided by Newcrest to test whether the tonnage, grades, and classifications reported for the Mineral Resources estimate can be reproduced. AMC confirmed this to be the case.

The Red Chris Mineral Resources estimate is an appropriate basis for Ore Reserve estimation.

5.3.14 Exploration and resource potential

Red Chris (including the GJ Property) comprises 204 mineral claims including five mining leases and is a joint venture between subsidiaries of Newcrest (70%) and Imperial Metals Corporation (30%).

Newcrest is currently completing exploration drilling programmes on East Ridge and Far East Ridge targets and that further drilling is planned to define the extents of the Main Zone, Gully Zone and Far West targets. AMC understands that an integrated strategic study encompassing East Ridge is planned for in CY24 following initial scoping level studies.

Newcrest - Independent Technical Specialist's Report

Grant Samuel & Associates Pty Ltd

0223041

Figure 5.4 Red Chris Near-Mine Targets

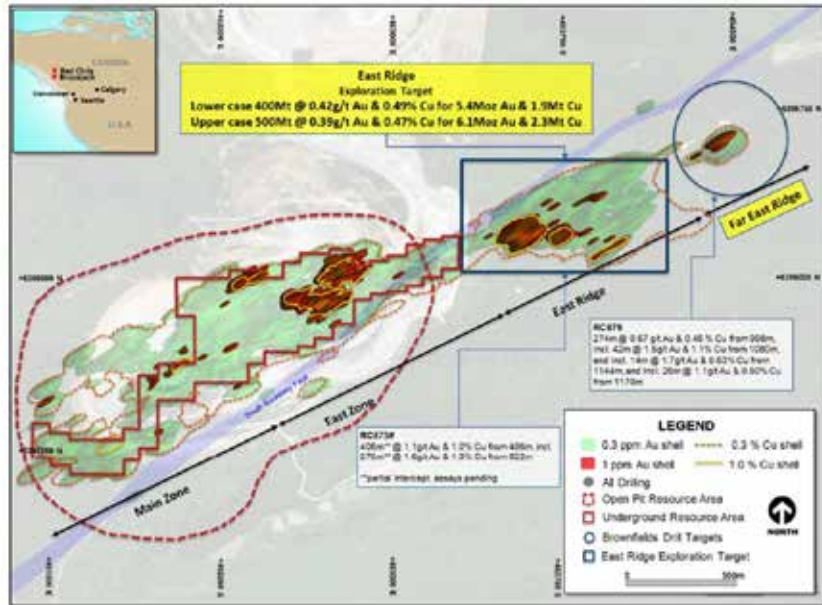
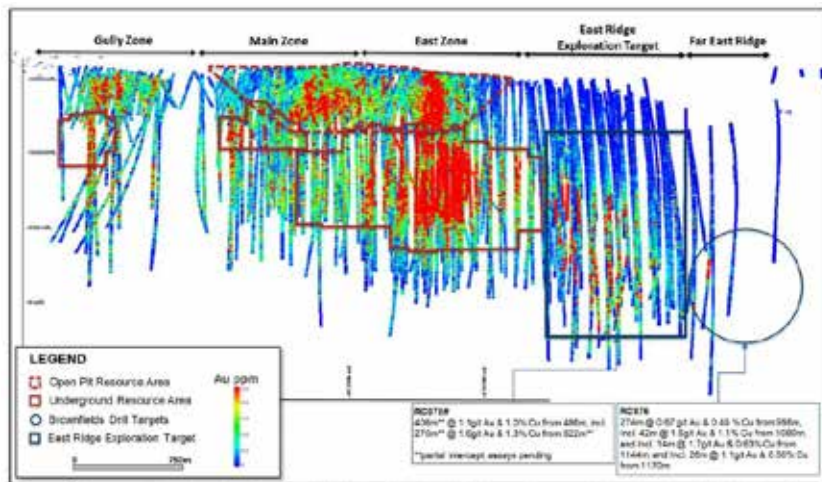

Figure 5.5 Mineralization Long Section View



The Red Chris property remains prospective for the discovery of additional deposits, and additional information is provided in section 9 of this ITSR.

AMC has reviewed the data and reports provided by Newcrest and agrees that the potential for Mineral Resource replacement as well as increasing the size of the Mineral Resource is high and that the targets identified by Newcrest and the risk ratings assigned are reasonable.

5.4 Geotechnical investigations

AMC reviewed the underground geotechnical aspects for Red Chris Block Cave Project primarily based on the PFS project report and Red Chris Technical report. The PFS geotechnical study has provided geotechnical inputs to the mine design in support of PFS, including rock mass characterization, ground support recommendations and geotechnical risks and mitigations, and

Newcrest - Independent Technical Specialist's Report

Grant Samuel & Associates Pty Ltd

0223041

future work into a feasibility study. The feasibility study is in progress, but data was not available to AMC at the time of this ITSR.

5.4.1 Data collection

Geotechnical core logging data of selected drillholes from resource drilling (13 holes, 2018 to 2020) and geotechnical drilling programme (16 holes, 2020) have been used to develop underground geotechnical design parameters for PFS. The information used as a basis of rock mass characterization and underground geotechnical design includes:

- Over 27,300 m of geological and geotechnical core logging.
- Discontinuity orientation data collected from structural logging of oriented cores and acoustical televiwer televiwer survey.
- Laboratory testing of intact rocks and discontinuity surfaces. Tests completed include point load index, uniaxial compressive strength, Brazilian tensile strength, and triaxial compressive strength.
- Major fault structures have been identified.
- In situ stress measurements were taken using Acoustic Emission method. A total of 18 samples from depths ranging from approximately 300 m to 1000 m were sent for testing. 12 samples were successfully tested, 6 were unable tested due to extensive internal micro fractures.

The geotechnical investigation has included essential activities. The work which has been carried out in accordance with industry-standard methods is considered to be sound.

5.4.2 Geotechnical characterization

Based on geological, structural and geotechnical data, 6 geotechnical domains have been developed. 5 domains were largely based on lithology units, including Bowser Sediments, Stuhini Volcanics, Stuhini Sediments and Porphyry Main and P2. Of all major fault structures intersecting the mine footprint, South Boundary Fault is the most significant structures and has poorer rock mass quality and identified as the 6th geotechnical domain.

Major fault structures have been located and investigated, 3D major structure model has been developed with South Boundary Fault, HW1 and HW2 Faults, East Zone Fault, and Dead Zone Fault being known to intersect the mining footprint. Discontinuity sets have been analysed based on oriented core measurements and televiwer surveys of selected drillholes.

Laboratory strength test results and IRS estimates show that intact rock units at Red Chris are typically medium strong to very strong.

Three rock mass quality classification are adopted at Red Chris: Q-system, RMR₈₉ systems and GSI (= RMR₈₉ - 5). Results of Q-system were used for empirical ground support design. Rock mass quality has been assessed by geotechnical domains to account for regional variation. Typical rock mass conditions at Red Chris are Very Good in terms of RMR₈₉ and described as massive, strong and brittle with minimal open fractures. Rock mass conditions are variable from blocky to highly broken zones of weak rock masses.

The Hoek-Brown (H-B) intact rock strength and rock mass parameters for hosting rocks (Stuhini Volcanics and Sedimentary) and Porphyry Main and P2 were derived based on strength tests data and GSI values.

AMC considers the following parameters be reviewed:

- 1 Identical Young's moduli were adopted in the Red Chris PFS for intact rock and rock masses in each geotechnical domain
- 2 Material constant $s = 1$ was adopted for H-B rock mass material constants.

Newcrest - Independent Technical Specialist's Report

Grant Samuel & Associates Pty Ltd

0223041

AMC understands these are under review in the developing feasibility study.

There is uncertainty in the in situ stress field. The acoustic emissions test results during the PFS show that the orientation of major principal stress is approximately 90° offset from that projected from a literature review, the world stress map, and the predominant orientation of known major local geological features (regional faulting and porphyry intrusion). In addition, the in situ stress magnitudes from acoustic emissions tests were relatively high. But the acoustic televiewer logging indicated that the horizontal stresses were lower given that there was no breakout observed along the drillholes. AMC considers that the in situ stress field and mining induced stress changes are critical to mine design and plan, which has great impacts on caving propagation rate and excavation stability. AMC understands that further stress measurements at various depths are being undertaken in the feasibility study.

Regional seismicity is not a concern at the Red Chris. Mining induced seismicity likely occurs but can be managed with appropriate measures such as hydraulic pre-conditioning; undercut favourable orientation with respect to major structures and adequate ground support systems.

Hydrogeological investigation show that Red Chris is a low-risk block cave due to presence of massive country rock with low permeability.

AMC considers that the rock mass characterization is adequate for a PFS level of study. AMC is aware that additional data collection has been undertaken by Newcrest to assess rock mass quality, strength and variation across the deposit and develop a geotechnical block model in the feasibility study, which is not available to AMC.

5.4.3 Cave propagation and subsidence modelling

A numerical assessment to model caveability and subsidence in the 2021 PFS. A large scale FLAC3D model was constructed to simulate the caving process. The model consists of final pit geometry to capture resulted pre-mining stress conditions prior to cave mining. All 5 major lithology domains and fault structures were included in the model.

Material properties and constitutive models were selected based on parameters derived from PFS rock mass characterization, assumptions, and modelling experience from similar projects. A number of sensitivity scenarios which include in situ stress scenarios and hydraulic fracturing pre-conditioning have been examined to investigate the impacts of orientations and magnitudes and pre-conditioning. The orientations adopted includes those obtained from AE tests and suggested from the world stress map. Horizontal stress magnitudes' scenarios include results from AE tests and reduced by 30%.

The modelling shows positive results that in all cases that caving was propagated continuously without sign of caving stalling or major deviations once cave initiation was obtained. The modelling results have shown that stress orientation is not critical for caving rate, but stress magnitudes do have significant impacts on caving rate. Lower horizontal stresses tend to decrease caving rate. The results also indicate the significance of hydraulic fracturing pre-conditioning in reducing hydraulic ratios for cave initiation in cases where lower stress ratios (Horizontal to vertical stress) occur.

Modelled cave subsidence shows no major risks for surface infrastructures, and stability analysis shows all major development chambers are stable with little risk of instability. Elevated damage around cave abutment likely occurs, which is acceptable and can be rehabbed during operation. Minor but acceptable damage is expected to the ventilation raises.

AMC considers that the modelling methodology and approach were appropriate for PFS level. However, the prediction of cave performance is largely based on numerical modelling, the modelling results rely on input parameters, which were based on limited data, assumptions and previous experience and may not be representative for Red Chris. AMC notes that the models

Newcrest - Independent Technical Specialist's Report

Grant Samuel & Associates Pty Ltd

0223041

have not been calibrated against actual behaviour and therefore the results should be considered relative indicators of geotechnical performance. There is a potential risk that cave propagation rate is lower than expected based on numerical modelling due to unrealistic modelling inputs.

5.4.4 Ground support

Ground support requirements were assessed using two approaches for empirical static ground conditions (Q-System) and dynamic conditions (Kaiser deformation-based ground support assessment approach). AMC considers the approaches adopted for excavation and ground support design are rational and appropriate.

During site visit on tours of existing decline development, AMC noted that MD dynamic rock bolts are being used for faster and easier installation than conventional grouted rebar bolts. The excavation profiles do not appear to be smooth with lots of overbreak being observed. AMC recommends Red Chris focus on improving drilling and blasting practice to achieve smooth excavation profiles thus to reduce shotcrete consumption and increase productivity.

5.4.5 Cave monitoring

Proposed cave monitoring programme includes cave marker, beacons, detectors, seismic system and other types of instrumentation such as instrumented rock bolts, extensometers. AMC considers it adequate for the PFS level. AMC understands that an instrumentation plan, installation plan and monitoring plan have been completed in the feasibility study but were not available to AMC.

5.4.6 Geotechnical risk and management

The key geotechnical risks that could affect cave performance have been identified and summarized as follows:

- There is uncertainty in the in situ stress field. In situ stress is important on cave propagation rate. AMC aware that additional stress measurements has been undertaken to remove uncertainty in the upper section of the rock mass. Further stress measurements at depth have been planned to confirm stress field at various locations from the exploration ramp as it reaches the MB1 extraction level.
- Material properties and constitutive models adopted in cave and subsidence modelling were based on limited data, assumption and previous experience and may be not representative for Red Chris. Cave propagation rate may be lower than expected. Further investigations are currently underway in developing the feasibility study.

AMC considers the PFS level geotechnical assessment is thorough, the methodologies and approaches used in geotechnical assessment and design are rational and appropriate. Geotechnical risks and mitigation measures were identified and the path forward into FS were proposed. There is no fatal flaw in the assessment.

5.5 Mining operations and Ore Reserves

5.5.1 Current mining operations

5.5.1.1 Open pit

The Red Chris open pit is comprised of two zones (Main Zone and East Zone). Active mining in 2023 is occurring in the Phase 7 cutback (Main Zone) with Newcrest scheduling (10 Mtpa tactical schedule) mining (Phase 5R) to occur in the bottom of the previous Phase 5 cutback in November 2024. The Phase 7 cutback is planned to complete in April 2026 and Phase 5R in May 2026. Figure 5.6 illustrates the entire open pit and the Phase 7 and 5R cutbacks.

Ore from the pit is classified as either high-grade, medium-grade, or low-grade based on its NSR value and modifying factors. Operationally, mineralized rock not meeting the low-grade NSR minimum, but still having a specific level of economic value, is classified as mineralized waste.

Newcrest - Independent Technical Specialist's Report

Grant Samuel & Associates Pty Ltd

0223041

Ore is hauled from the pit and is taken to either the primary crusher (direct fed), a blending stockpile, or a long-term stockpile. Mineralized waste is hauled to a long-term stockpile. As required to meet either quality and/or processability requirements, ore is blended prior to being fed into the primary crusher.

Figure 5.6 Plan view of the Main Zone and East Zone pits

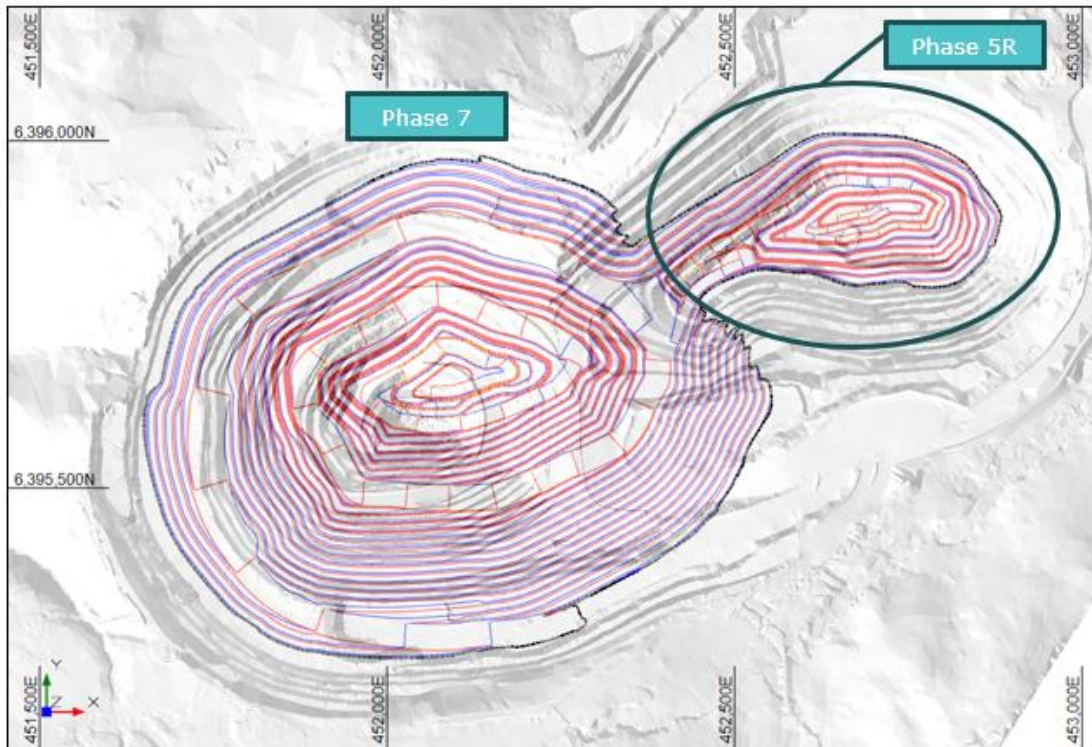

Waste is classified as either NAF or PAF and is hauled from the pit to the WRD where it is placed based on its classification. The WRD foundation utilizes a NAF blanket upon which PAF is placed. If the WRD construction sequence permits, NAF can be direct placed on the WRD foundation, with excess NAF being placed onto a long-term stockpile. The majority (81% over FY24, FY25, and FY26 of the current mine plan) of the waste (PAF) is direct placed onto the WRD. Figure 5.7 presents an overview of the WRD configuration, as well as locations of the low-grade ore and mineralized waste stockpiles.

Annexure 1. Independent Expert's Report

Newcrest - Independent Technical Specialist's Report

Grant Samuel & Associates Pty Ltd

0223041

Figure 5.7 Plan view of the WRD and the low-grade and mineralized waste stockpile.

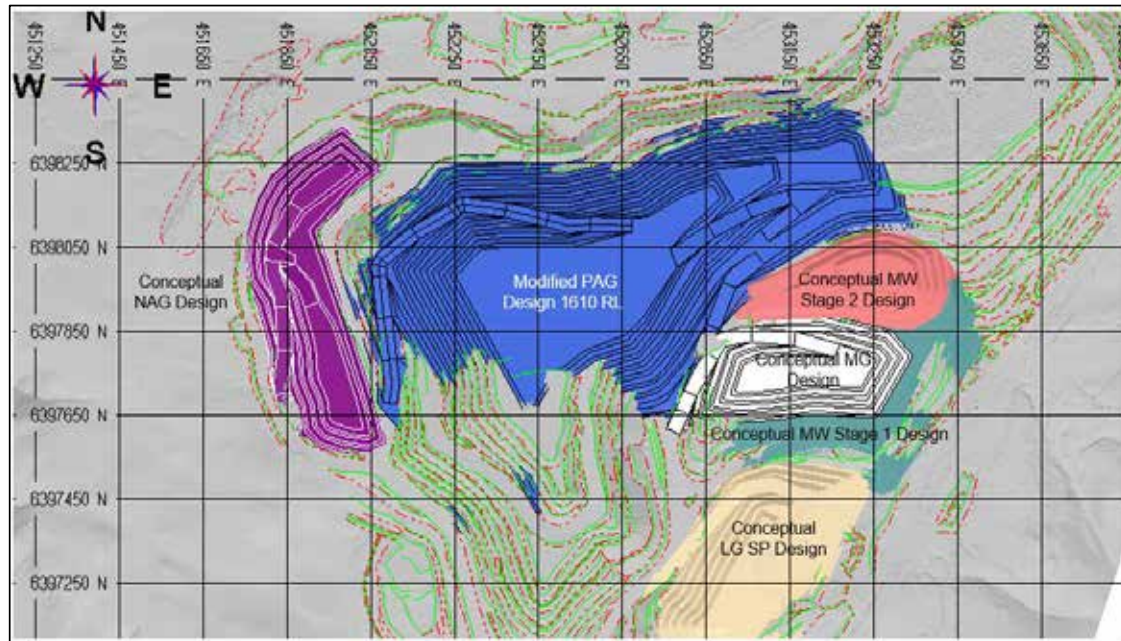

Mining is performed by Newcrest via conventional truck (primarily Caterpillar 793 trucks) and shovel (P&H 2800, Komatsu PC7000, Hitachi EX3600) operations using 12 m high benches in a combination of single- and double-bench configurations throughout both the Main Zone and East Zone pits. Blasthole (production and pre-split) drilling is performed by rotary blasthole drills, with the pre-split drilling being performed in at least areas where the final pit wall will be in a double-bench configuration. Ore stockpile rehandle and reclaim is performed with a front-end loader (Caterpillar 994) and/or hydraulic shovel or excavator (Hitachi 3600, Komatsu PC2000). Phase 5R mining is planned to be mined with additional smaller mining equipment (Komatsu PC1250 excavator and Caterpillar 745 trucks).

Material aspects of the current plan is as follows, noting that Newcrest is planning to complete open pit mining operations in coordination with ramp-up of the underground mine:

- Phase 7 – Mined continuously through to April 2026.
- Phase 5R – Mined continuously from November 2024 through to May 2026.
- Stockpiled Ore – Significant component (up to 70% in FY27) of the mill feed from completion of Phase 7 and Phase 5R (May 2026) through FY28 and tapering to nil within FY29.
- Underground – Ore feed commences in FY25 and ramps-up to supply all mill feed in FY29.

Once open pit mining is completed, mill feed consists of underground ore and stockpiled ore, until such time that the underground can supply all mill feed.

The planned bench turnover generally has a one month overlap at the end of the bench above transitions to the bench below. The only material exception being both the Phase 7 and Phase 5R pit bottoms where for a two-month period, three-and-a-half benches are being mined in March and April 2026. It should be noted that the Phase 5R cutback, as mentioned above, is planned to be mined with a different (additional) loading and hauling fleet.

Newcrest - Independent Technical Specialist's Report

Grant Samuel & Associates Pty Ltd

0223041

5.5.1.2 Underground

Decline development for underground access to Macro Block 1 (MB1), Macro Block 2 (MB2), and Macro Block 3 (MB3) commenced in June 2021. The first of several ventilation raises has been installed connecting the midpoint of the decline to surface. In May 2023, development of the lower portions of the conveyor decline commenced. Construction of the conveyor portal and upper conveyor decline will commence in late 2023.

Mine decline development will continue to the 500m level, where the extraction level will be established. The undercut level will be established 25m above the extraction level. The first scheduled ore from caving operations at MB1 will occur in 2027, and full production will be established by 2028. The mining sequence will be in the order of MB1, MB2, and MB3 as indicated in Figure 5.8. This sequence is based on mining the high-grade portion of the Ore Reserve, MB1, first. Mining of MB2 will be established prior to commencement of MB3 due to geotechnical constraints.

Figure 5.8 Red Chris block cave production sequence

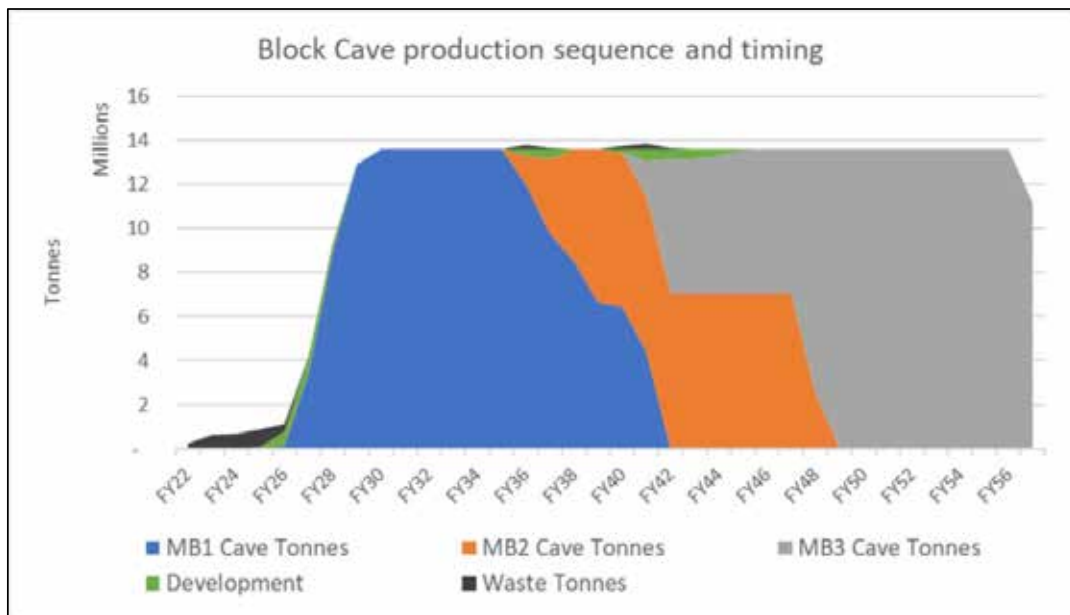

Note: This production sequence is shown at 13.6 Mtpa, however the feasibility study is based on 15 Mtpa.

The underground inventory consists of both development and block cave ore as shown in Table 5.4.

Table 5.4 Scheduled inventory by material type

Ore Type	Mt
Development	4.6
MB1 Cave	154.6
MB2 Cave	75.3
MB3 Cave	171.0
Total	405.5

The production rate is scheduled to be 13.6 Mtpa, Newcrest's feasibility study is planning to increase the production rate to 15 Mtpa. The planned mining fleet consists of standard diesel-powered jumbos, loaders and trucks during the development stages. Due to the relatively short

Newcrest - Independent Technical Specialist's Report

Grant Samuel & Associates Pty Ltd

0223041

haulage distance for MB1 and MB2 from caving draw points to the crusher station, only loaders will be used for ore transport. In MB3, due to the longer hauls, it is proposed to utilise loaders and trucks for ore haulage. Newcrest is currently operating battery electric trucks and loaders at other operations. Should the trials identify efficiencies, battery electric loaders will be considered for production operations.

An underground crusher will be installed to service the three Macro Blocks. The crusher will be fed via five tip points located around the top of the crusher on the extraction level. The crushed material will be fed to a ROM bin, which in turn regulates feed to the conveyor system for transport to surface. The conveyor system consists of three conveyors, with transfer stations located where the conveyor changes directions. The conveyors are hung from the roof of the decline to allow passage of service vehicles underneath. The crusher and conveyor system are designed for a maximum of 18 Mtpa.

Figure 5.9 Plan View Red Chris Underground

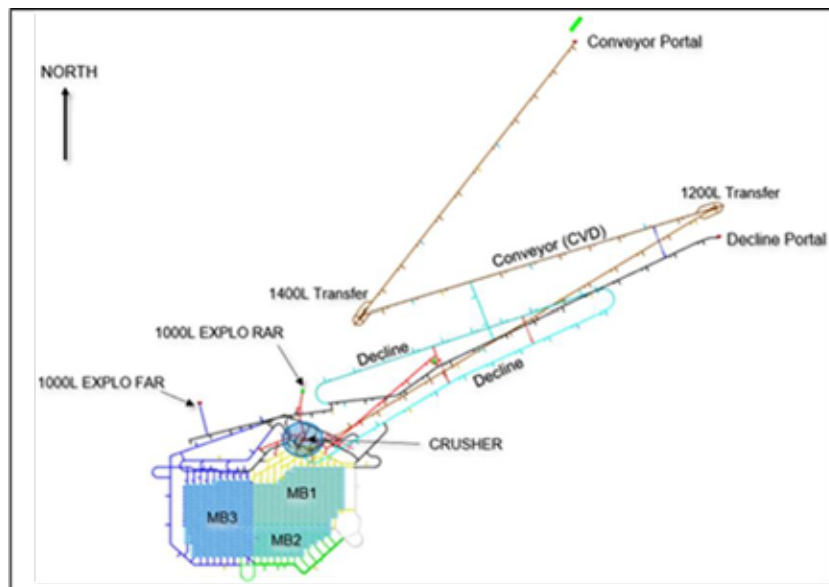

The mine will consist of 3 surface ventilation shafts, two exhaust and a single intake shaft. Intake air heating systems will be installed at both decline entrances to increase air temperatures to a minimum of +2°C.

5.5.2 Future mine expansion

5.5.2.1 Open Pit

Beyond the current open pit plan to mine Phase 5R (East) and Phase 7 (Main), a Phase 8 option was considered as a cutback option to the East pit. However, the high stripping ratio of Phase 8 makes it not economically viable. The current pit designs Phase 5R and Phase 7 extract all of the open pit Ore Reserve.

5.5.2.2 Underground

The Technical Report presented an upside case for the increase in mining and processing rates to 15 Mtpa. The increase in mining rate will be achieved with an addition to the number of production loaders extracting material from the draw bells and transporting it to the crushing circuit. The crushing and conveyor systems are rated at approximately 15 Mtpa. Changes are also planned for the processing plant as outlined in the metallurgy section.

Newcrest - Independent Technical Specialist's Report

Grant Samuel & Associates Pty Ltd

0223041

Newcrest identified prospective additions to the Mineral Resource and Mineral Reserves at Red Chris which are reported as Exploration Targets. Of note are Exploration Targets (East Ridge 1 and East Ridge 2 which are estimated to contain approximately between 400Mt containing 5.4Moz gold and 1.9Mt copper to 500Mt containing 6.1Moz gold and 2.3Mt copper. Newcrest advises there are reasonable prospects for the conversion of some percentage of these Exploration Targets into Mineral Resource. Newcrest advises it is undertaking studies and additional exploration activities to convert the Exploration Targets to Mineral Resources and Ore Reserves over time. The East Ridge Exploration Target presents an opportunity to extend the life of the asset.

The conceptual layout presented in Figure 5.10 is for integrating the East Ridge Exploration target into the Red Chris mining design.

Figure 5.10 Conceptual integration of East Ridge Exploration Target.

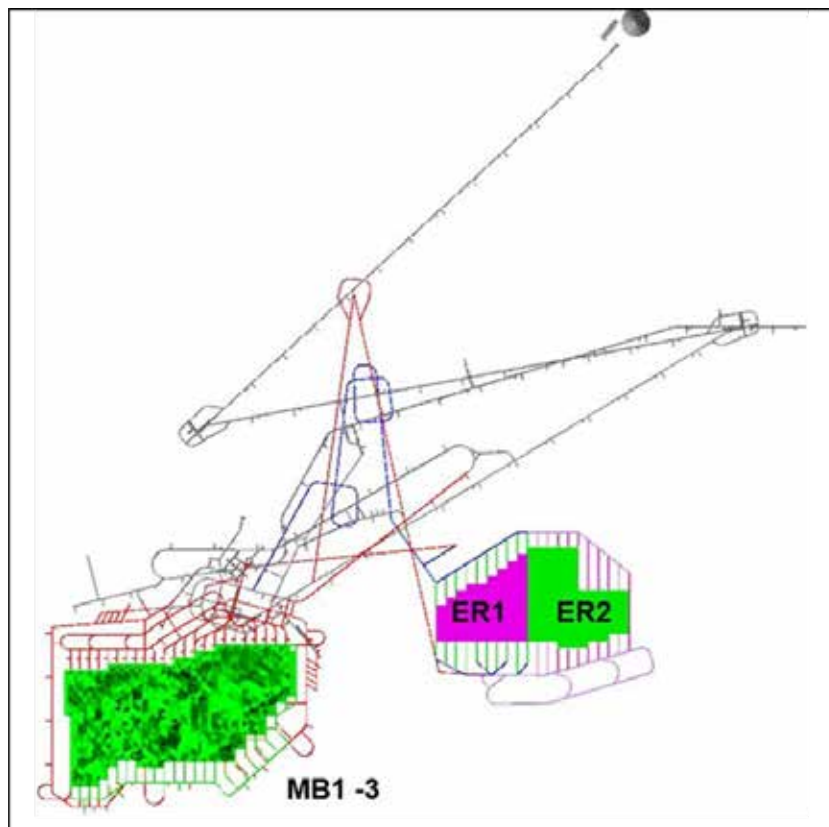

5.5.3 Ore Reserves and estimation process

The Red Chris Ore Reserve estimate at 30 June 2023 is presented in Table 5.5 on a 100% basis. The estimate was prepared by Newcrest. Newcrest considers Red Chris to be one of its material properties.

Annexure 1. Independent Expert's Report

Newcrest - Independent Technical Specialist's Report

Grant Samuel & Associates Pty Ltd

0223041

Table 5.5 Red Chris Ore Reserve estimate as at 30 June 2023

Classification	Tonnes Mt (Dry)	Grade		Contained Metal	
		Au (g/t)	Cu (%)	Au (Moz)	Cu (Mt)
Red Chris Open Pit (Probable)	42	0.40	0.47	0.54	0.20
Red Chris Open Pit Stockpiles (Probable)	7.9	0.16	0.24	0.040	0.019
Red Chris Underground (Probable)	410	0.55	0.45	7.2	1.8

Notes:

- All data reported is on a 100% asset basis.
- Reduction due to removal of waste stripping and changes to mine design. Newcrest attributable share 70%.
- Red Chris Block Cave Feasibility study and due for completion in CY23. Newcrest attributable share 70%.

5.5.3.1 Open pit

Details on the Ore Reserve estimation process are not available for the June 2023 Ore Reserve.

Material classification is based on the NSR of the material relative to the value of the material considering its element recovery and selling costs. A total of six material types were delineated (Table 5.6) based on an NSR value of at least CAD\$20.33/t milled. No additional dilution or ore loss factors were applied to the Ore Reserve estimate, outside those applied to the Mineral Resource. Any Inferred Mineral Resources in the mine plan were converted to waste for the estimates.

Table 5.6 Material types by NSR value

Cut-Off Conditions	Ore Reserve Class
NPR < 2 and all Bowser Sediment	Waste
NPR > 2 (excluding Bowser Sediment)	Waste
NSR > PCST + GA + (1* SPRC)	Waste
NSR > PCST + GA + (0.50 * SUS + (1.0 * SPRC)	Ore
NSR > PCST + GA + SUS + (0.2 * SPRC) + 5	Ore
NSR > PCST + GA + SUS + (0.2 * SPRC) + 20	Ore
Default	Waste

Notes:

- NPR = neutralizing potential ratio.
- NSR = value of ore as placed into crusher as processing decision point; NSR is fully costed.
- PCST = concentrator unit cost.
- GA = G&A unit cost.
- SPRC = stockpile recovery cost - 20% reclaim assumption.
- SUS = sustaining capital unit cost.

5.5.3.2 Underground

Ore Reserves were estimated for MB1, MB2, and MB3 only. Only gold and copper were taken into account for revenue purposes in the Ore Reserves. The Red Chris Block Cave Pre-Feasibility Study completed in 2021 is the basis for the Ore Reserve estimate.

A standard process for Ore Reserve estimation was followed at Red Chris: mine optimisation, mine design, development and production scheduling, and economic modelling were undertaken. All modifying factors were included into the process, that is, dilution and recovery factors.

Red Chris underground utilised a value-based cut-off, determined from NSR, for determining its Ore Reserves. A NSR calculation considers the following factors:

- Revenues from sales of products.
- Metallurgical recovery assumptions.
- Transport costs.
- Refining and royalty charges.

Newcrest - Independent Technical Specialist's Report

Grant Samuel & Associates Pty Ltd

0223041

- Site operating costs including
 - Mining costs.
 - Processing costs.
 - Relevant site general and administration costs.
 - Relevant sustaining capital costs.

The NSR values have been calculated for each Macro Block.

- Macro Block 1 CAD\$22.00/t
- Macro Block 2 CAD\$22.80/t
- Macro Block 3 CAD\$22.80/t

Based on the above NSR values, the Ore Reserves were calculated for each Macro Block (refer Table 5.6). The Ore Reserves for Red Chris are based on Indicated Mineral Resources and are classified as Probable Ore Reserves.

5.5.4 Resource development and future mining concepts

5.5.4.1 Underground

Future underground development includes the East Ridge Exploration Target, which is a well-drilled area east of the main deposit. It is likely that East Ridge and the Mineral Resources at Red Chris will contribute to the LOM plan as studies advance on these areas.

In addition to East Ridge there are several other exploration projects locally and regionally in the pipeline at various levels of investigation from reconnaissance to projects with an advanced level of drilling.

5.6 Mineral processing

5.6.1 Processing plant description

The processing plant milled approximately 9.5 Mtpa over the past twelve months and processes open pit ore from two main zones and consists of a SABC comminution circuit typically operating at a higher P_{80} 180 μm grind size (than the target of P_{80} 150 μm) to accommodate higher throughputs. The processing plant is operated to maximise sulphide mineral recovery, hence minimising acid generating minerals going to tailings. Flotation tailings are passed through a final hydrocyclone stage and the coarse fraction is used as tailings dam construction material.

The processing plant produces a copper concentrate which contains around 10 g/t Au to 12 g/t Au and has a copper grade between 20% Cu to 23% Cu with the main diluent being both pyrite and non-sulphide gangue minerals.

Testwork has identified that future ore sourced from Lower East Zone underground ore is significantly harder than open pit ore and therefore additional grinding capacity will need to be installed to accommodate higher throughputs. As well as this additional flotation capacity, that has already been identified in project work, will need to be installed.

Summary of all major ore processing equipment includes:

- Primary crusher
- SAG Mill, 34-foot diameter, with pebble recycle crusher
- Ball mill in closed circuit, 24-foot diameter
- Flotation Roughing with 2 x Eirez Stack Cells, and 7 x Outotec cells
- Flotation cleaning with 3 x flotation columns and 5 x Outotec cleaner scavenger cells
- Regrind ball mill in series with a Regrind Vertimill 1500 targeting P_{80} 30 μm
- Tailings thickener and filter press

Newcrest - Independent Technical Specialist's Report

Grant Samuel & Associates Pty Ltd

0223041

Figure 5.11 Red Chris – processing plant flow diagram

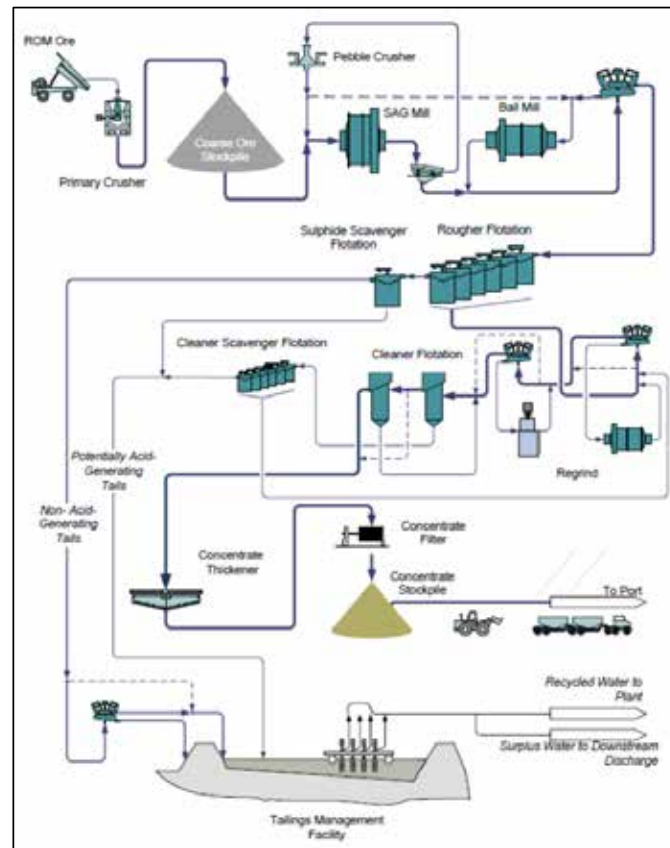

5.6.2 Metal recovery and concentrate grade

Red Chris has a low-sulphide orebody containing chalcopyrite (very low bornite content) and pyrite as the main sulphide minerals resulting in concentrate grade targets 23% Cu to 24% Cu. Gold recovery in FY23 averaged 52.3% and copper recovery around 76.6% with a copper concentrate grade of 21.1% Cu. There is additional revenue with silver recovered from final products.

Gold deportment is (approximately) equally distributed between free gold grains, copper, pyrite and non-sulphide gangue. Gold in all forms is very fine grained.

AMC calculated gold and copper recoveries based on formula as specified in the Technical Report.

- Copper recovery (%) $\sim 76.5 + 11.9 \cdot \text{Cu}$ (maximum copper recovery of 92%)
- Gold recovery (%) $\sim 72.5 + 9.3 \cdot \text{LN}(\text{Au/S})$

For East Ridge blocks, the total average Au/S ratio was used in the gold recovery formula.

The main penalty elements monitored in concentrates include mercury and antimony, however these are within buyer specifications for most ore types. These can of course be blended to lower values if necessary.

Newcrest - Independent Technical Specialist's Report

Grant Samuel & Associates Pty Ltd

0223041

5.6.3 Concentrate transport and marketing

Concentrate is transported to the Port of Stewart bulk terminals 320km away via Highway 37 and housed within sheds until sufficient stockpile to load ships.

5.6.4 Tailings storage

LOM tailings containment is provided by a single impoundment with natural topography and three dams constructed for tailings retention. Along with existing north and south dams, the construction of a new northeast reclaim dam is planned. Two smaller reclaim dams are located further downstream to aid in water management. The TIA design uses the most current mine plan with a mill throughput of 30,000 tpd for a 28-year mine life to FY43 with an approximate total of 300Mt of tailings.

Flotation tailings are passed through a final hydrocyclone stage, as such to create a coarse stream of material that can be recycled as tailings dam construction material and the finer stream of material is deposited into the TIA.

Following the most recent review of the TIA facilities it was recommended additional instrumentation for monitoring deformation, wells as well as additional weirs to be included to mitigate medium to low-risk issues identified. Overall, it was found that the structures satisfy storage requirements, and the as-built configurations meet stability requirements.

5.6.5 Future ore processing plans

Red Chris East Ridge has been identified as the next exploration target and will significantly increase the size of the Ore Reserve. Early indications are that this volume alone is expected to double the gold Ore Reserve and almost double the copper Ore Reserve. Other porphyry copper deposits have been identified nearby with the expectation that the area will grow into a long-term mining district.

Project work has identified that further ore sources that should have higher recoveries than currently produced, however in order to achieve this additional processing plant equipment will be required and is being identified in these ongoing studies.

The increased processing throughput predicted for the next 4 years could be achieved, but only with significant changes to the flowsheet (13.6 Mtpa to 15 Mtpa). Some of these have already been identified in the feasibility study and will obviously include a coarsening of the primary grind size, additional grinding and regrind capacity as well as increased flotation capacity and installation of processing units that specifically target coarse copper particles.

5.7 Site infrastructure and services

5.7.1 Power supply

Power supply is provided by BC Hydro via a single, 287 kV alternating current overhead high voltage transmission line from the Skeena substation approximately 500 km away. Emergency power requirements for critical systems are met by 2 x 1.27 MW diesel generators for operations and a single 500 kW diesel generator of the camp facilities.

5.7.2 Water supply

Water supply is from a number of distribution systems including fresh water, reclaim water, runoff water, potable water, utility water, and fire water. Reclaim water from the TIA is the major source of process water. A portion of the reclaim water is filtered and used in areas of the processing plant that require a higher quality of water (this includes fire water supply).

Newcrest - Independent Technical Specialist's Report

Grant Samuel & Associates Pty Ltd

0223041

5.7.3 Other infrastructure

The mine site is connected by 23 km of sealed road to the nearest highway (Highway 37) at Tatogga and mine security is located at this junction point, preventing unnecessary site traffic. The camp, administrative buildings, warehouses, processing plant, open pit, and TIA are linked by gravel roads.

The camp will be expanded by around 600 additional rooms to accommodate/support new construction activity and parts will be decommissioned as these are no longer suitable. The aim is to modernise facilities across the entire camp in order to attract highly skilled workforce to the site.

Along with the camp site, further upgrades due to the expansion will include new site buildings, site drainage, power supply substations, communications network, roads, and a number of civil projects.

5.8 Environmental, Social, and Permitting

5.8.1 Environmental and regulatory approvals background

The project received the following key approvals:

- Provincial Environmental Assessment Certificate (M-240) issued on 4/05/2012. A number of amendments have subsequently been received with the most recent amendment received on 8/12/2022 authorising pre-production and tailings thickener changes.
- Federal Canadian Environmental Assessment Act Decision Statement issued on 24/08/2005 valid for a period of five years. Extension until 2010 was received in July 2010. A number of amendments have subsequently been received with the most recent amendment to certificate M05-02) received on 3/05/2021.
- Discharge Permit 105017 issued on 23/09/2013 for effluent discharges to the TIA. A number of amendments have subsequently been received with the most recent amendment received on 15/08/2019 to transfer ownership to Newcrest.
- Discharge Permits 105017 and 106004 for discharges to air and waste-water discharges respectively.

It is noted that key approvals are in place for development of the box-cut and exploration decline (received 2/02/21 and 27/04/2021 respectively). No approvals have been obtained for development of an underground mine.

All the various provincial and Federal permits required to construct, operate and decommission the mine were received in 2015.

5.8.2 Environmental and social assessments, control, and management

Red Chris has an Environmental Management System which consists of a series of management procedures and monitoring programs that integrate engineering design and environmental planning. Key elements include aspect specific environmental management Plans, an awareness and training programme and environmental monitoring plans.

5.8.3 Future approvals

Approvals will be required in the future for:

- Phase 3 – pre mining underground development including extension of the exploration decline, development of a conveyor decline, access to the orebody and underground development to support a block cave mine.
- Phase 4 – Block cave underground mine (MB1).
- Phase 5 – Block cave underground mine (MB2 – MB3).

Newcrest - Independent Technical Specialist's Report

Grant Samuel & Associates Pty Ltd

0223041

Block caving approvals have been staged as:

- Mining of MB1 will only require amendment of existing provincial approvals. As the subsidence zone will be within the current permitted disturbance area and changes to the TIA will not require an increase in permitted footprint or embankment elevation.
- Mining of MB2 and MB3 will require amendments to both existing Federal and provincial approvals as the subsidence zone will exceed the current permitted disturbance, changes to the TIA extent and height will be required and as the project life will extend beyond 2040.

The PFS identifies all key Federal and Provincial Approvals block caving as being scheduled to be in place by May 2024 and notes this is considered to be aggressive.

Amendments to the EA Certificate will be required to allow underground mining. Also south reclaim dam extension may need to convert tenure from Mineral Claim 541621 to a mining lease.

5.8.4 Greenhouse gas emissions and renewable energy targets

Red Chris reported Scope 1 and 2 emissions of 101,539 and 13,048 tCO₂^e respectively for the FY22 reporting period. The majority of the Scope 1 emissions arise from use of diesel in haulage and production.

The emissions intensity by tonne of ore milled for Red Chris for FY22 was 12 kg CO₂^e compared to the Newcrest average of 33 kg CO₂^e. Newcrest states that it anticipates emissions intensity to decline further as Brucejack transitions from open pit operations to underground operations and diesel use is reduced.

5.8.5 Cultural Heritage

Red Chris is located within the area claimed by the Tahltan People as their traditional territory. The Iskut Band members land use in the Red Chris area and surrounds includes camping, hunting, access trails, plant harvesting and trapping. The land also includes an important migratory route and wintering habitat for the various animals hunted and trapped by the Iskut. The local peoples are active users of the Stikine Country Protected Area which is located west, north and east of Red Chris.

Three Tahltan communities are located within the area of Red Chris–Iskut, Telegraph Creek and Dease Lake with each having about 200-300 registered Tahltan Nation members. There are three Reserves in and around Dease Lake and 11 Reserves near Telegraph Creek. Culturally important villages and assembly sites are located throughout the Tahltan Nation territory.

A Memorandum of Understanding was entered into in January 1994 between the Tahltan and Iskut First Nations and BC Metals, the Red Chris owners at that time. This established a set of principles under which Red Chris and the two First Nations would work together in development of Red Chris. In 2008, the Red Chris owners entered into a Traditional Knowledge Agreement with Tahltan Nation so this knowledge could be applied to archaeological studies and other works.

In July 2015, Imperial Metals (then Red Chris owners), the Tahltan Central Government, Iskut Band and Telegraph First Nation signed an Impact, Benefit and Co-Management Agreement (IBCA) that provides the basis for a working partnership between the parties. This agreement was amended and restated in August 2019 between Newcrest Mining Limited, the Tahltan Central Government, Iskut Band and Telegraph Creek First Nation. The IBCA provides the basis for a LOM partnership covering a range of area including employment, training and interaction on social and environmental matters. The parties are also working together on joint action plans and agreements for regulatory permitting.

A large number of baseline archaeological studies have been conducted for the Red Chris area. Surveys have identified 46 pre-contact archaeological sites and seven post contact heritage sites

Newcrest - Independent Technical Specialist's Report

Grant Samuel & Associates Pty Ltd

0223041

in the project area. Of these, the majority are obsidian lithic scatters. 32 sites have been impacted as a result of construction and operation of the TIA.

Through the IBCA, several committees have been established and these form significant forums for consultation. These include:

- **Project Advisory Committee (PAC)** comprised of members of Red Chris and Tahltan Central Government. This committee serves as the formal mechanism for communication between the parties with respect to the mine and any associated works.
- **Environmental Oversight Committee**, which is a forum for dialogue between the Red Chris, Tahltan Central Government, and Tahltan Nation representatives with the objective of enhancing the Red Chris's environmental performance and compliance.

A Consultation and Engagement Plan has been developed and approved by the PAC.

Two committees have been developed for consultation with regulatory authorities:

- **Red Chris Monitoring Committee:** This is a requirement of the mines Act permit and is co-chaired by representatives of Red Chris and the Tahltan Nation with representatives from the Ministry of Environment, and Climate Change Strategy, Ministry of Energy, Mines and Low Carbon Innovation, Ministry of Forests, land and Natural Resources Operations and Rural Development.
- **Wildlife Management Advisory Committee:** This is a technical working group with ongoing collaboration between Red Chris, regulatory agencies, and the Tahltan Nation.

Condition 8(a) of M-240 requires copies of all material reports and plans relevant to the permit including annual monitoring reports and material changes to the approved Reclamation and Closure Plan to be provided to the Tahltan Central Government, Iskut First Nation and Tahltan Band.

5.8.6 Rehabilitation and closure planning

Red Chris has an approved Mine Closure Plan dated December 2021. The plan was modified as part of the transfer to Newcrest and inclusion of approvals for the boxcut and decline for the development of an underground mine.

Mine closure and reclamation planning are stated to be at a conceptual stage. Mine Closure planning is integrated within the mine planning process. The Mine Closure Plan dated December 2021 identifies a number of areas of uncertainty/areas for improvement and a work programme is identified to address these going forward.

The primary aim of Red Chris's Mine Closure Plan is to return areas disturbed by mining activities to locally common land use and capability similar to that in the immediate surrounding area focusing on restoration of wildlife habitat.

The extent of disturbance as at December 2021 was stated to be 1,467.1 ha versus the approved LOM disturbance of 1,852.3 ha.

Red Chris is required to maintain security with the Province of British Columbia for CAD\$74.2M as of 31 January 2023 (C\$51.9M corresponds to Newcrest's 70% attributable interest in Red Chris). The total security is required to be increased to CAD\$134.6M (C\$94.2M corresponds to Newcrest's 70% attributable interest in Red Chris) by 31 January 2024.

Conditions of M-240 specifically requires the Proponent to covering all closure and reclamation costs notwithstanding the security posted.

Newcrest - Independent Technical Specialist's Report

Grant Samuel & Associates Pty Ltd

0223041

Limited opportunities for progressive reclamation have been available to date. Small areas available for reclamation have been used for trials to help inform future activities. Once the pit reaches its final water level (circa 130 years post closure), excess water will be discharged.

The closure strategy for the open pit involves cessation of dewatering and allowing groundwater inflows, surface water runoff, direct precipitation and WRD seepage to gradually fill the pit. Pit lake modelling indicates potential water to be acidic and contain elevated metals, meaning that pit water may need treatment prior to discharge.

It is estimated that about 98% of the waste rock to be generated by Red Chris is PAF. Ore, including low-grade material is also characterised as PAF. The WRA has been designed and is being constructed to manage PAF waste rock. A non-PAF blanket has been constructed at the base of the RSA. Contact water is collected and pumped to the processing area or TIA. Closure planning requires construction of an engineered cover to prevent acid formation. Design of the cover system is in early stages.

Tails are predicted to be a mixture of NAF and PAF with the PAF component needing to be maintained under an earthen or water cover to prevent acid generation. The Mine Closure Plan aims to place NAF tails at the perimeter beaches. PAF tails will be contained to the central area of the TIA where they will be kept in a permanently saturated state by cover with a minimum of 2 m of water cover to prevent oxidation. The inundated area will have a spillway constructed to allow discharge of flows greater than the Probable Maximum Flood. Post closure, the TIA is predicted to be in a negative water balance and will need to have groundwater pumped onto it to maintain the water cover. Treated pit lake water may also be discharged to the TIA long term to maintain its water cover.

Water management is recognised in the MCP as being a key issue. The current approved MCP states that long term water treatment will be required post closure. As required by permit conditions, Newcrest submitted a reclamation liability cost estimate for the portions of Red Chris located on Mining tenure.

A full project closure cost estimate dated 13 December 2021 was prepared by Newcrest noting this addresses closure of all project aspects regardless of land tenure. A total closure cost of CAD\$172.4M was estimated. This cost is inclusive of human resource costs of CAD\$8.6M (employee benefits/redundancies), social costs of CAD\$2.5M and contingency allowances of CAD\$22.2M. The majority of the cost is forecast to be realised over a four-year period from FY44 to FY47.

The closure costs appear to be realistic and have been calculated from first principles using recognised methods and inputs. The most significant risks will be successful capping of the RSA and TIA and management of potentially contaminated water post closure from the RSA, TIA, and open pit requirement for ongoing water treatment post closure. AMC notes that water treatment costs included were very low (CAD\$462,250 versus estimate of CAD\$14M) as they are predicted to only be required post filling of the pit (circa 130 years post closure) and discounting over the long time period has a significant impact on costs. AMC also notes that this is heavily reliant on closure strategies for the RSA, stockpiles and TIA being 100% successful. Given the engineering cover for the TSA is currently only conceptual in nature, this is a significant assumption. Regulators can realistically be expected to require water treatment to occur unless discharge criteria can be met and to continue until closure criteria can be demonstrated to be met.

5.9 Costs

5.9.1 Operating costs

Historical operating costs for Red Chris are summarised in Table 5.7. Unit costs for mining, processing, and G&A are shown in Table 5.8.

Annexure 1. Independent Expert's Report

Newcrest - Independent Technical Specialist's Report

Grant Samuel & Associates Pty Ltd

0223041

Table 5.7 Red Chris historical operating costs (reported on 100% basis)

Operating Costs	Units	FY21	FY22	FY23
Surface mining	CAD\$M	140.9	155.0	180.0
Processing	CAD\$M	92.9	94.9	124.1
G&A	CAD\$M	106.3	103.7	132.6
Concentrate transport	CAD\$M	20.7	26.6	23.9
TCs/RCs and Penalties	CAD\$M	35.0	36.3	38.9
Royalty	CAD\$M	6.6	8.0	7.1

Source: Various Newcrest reports, public documents and company advice.

Table 5.8 Red Chris historical unit operating costs (reported on 100% basis)

Activity	Units	FY21	FY22	FY23
Mining	CAD\$/t ore mined	4.13	4.42	5.79
Processing	CAD\$/t ore milled	9.65	10.23	13.34
G&A	CAD\$/t ore milled	11.05	11.19	14.25

Source: Various Newcrest reports, public documents, and company advice.

Physicals

For the period covering FY20 through FY23, Newcrest has on average mined the budgeted ore quantities (4% more) at nearly the budgeted Au and Cu grades (4% and 5% less respectively). Although the mill ore feed was materially (9%) lower than budget, the ore that was fed achieved both Au and Cu budgeted grades (5% and 1% more respectively). Total material movement has shown a material shortfall in each FY (14% less on average).

Costs

While the average total mining cost was achieved, the lower than budgeted total material moved unfavourably impacted the unit mining costs. In FY22 and FY23, unit processing costs were over-budget as were total administration costs. Costs were increased due to the impact of Covid-19, higher labour, accommodation, and transport costs, and higher maintenance costs.

5.9.2 Capital expenditure

No capital expenditures are planned for the balance of the open pit operation. The Newcrest LOMP includes a significant capital allowance for the development of underground access, cave development, processing plant expansion, and surface infrastructure.

5.10 AMC production cases

Newcrest provided AMC with a LOM production and cost schedule (Newcrest LOMP) for Red Chris together with supporting information. The schedules are presented on an annual basis.

Based on the information provided by Newcrest, discussions with Newcrest personnel, and observations made during AMC's site visit, AMC developed two production cases:

- AMC Production Case 1 is based on the higher confidence elements of the Newcrest LOMP physicals and reflects AMC's adjustments to the timing of mine development, mining and treatment costs and an adjustment to the LOM metallurgical recovery estimates.
- AMC Production Case 2 represents the Newcrest LOMP which AMC considers is the upper reasonable limit of the potential for Red Chris.

Newcrest - Independent Technical Specialist's Report

Grant Samuel & Associates Pty Ltd

0223041

5.10.1 AMC Production Case 1

A summary of AMC Production Case 1 is presented in Table 5.9 and Table 5.10.

The open pit production schedule has been altered from the current Newcrest mine plan to reflect a delayed completion of the Phase 7 and 5R pit bottoms.

Capital expenditure is adjusted in FY24 and FY25 to allow for underspend in FY23.

For underground operations, only MB1, MB2, and MB3 are scheduled. The schedule closely follows that completed for the PFS in 2021. The ore mining and processing rate is limited to 13.6 Mtpa.

Table 5.9 AMC Production Case 1 – Red Chris production schedule

Estimate	Units	FY24	FY25	FY26	FY27	FY28	FY29 to FY38	FY39 to FY48	FY49 to FY58	Total LOM
Underground ore mined	Mt	-	0.06	0.81	4.1	9.3	135.3	135.9	120.0	405.5
Open pit ore mined	Mt	12.5	18.6	12.5	-	-	-	-	-	43.7
Copper grade	%	0.4	0.5	0.6	0.5	0.5	0.6	0.4	0.4	0.45
Gold grade	g/t	0.27	0.42	0.6	0.51	0.63	0.8	0.4	0.4	0.54
Ore milled	Mt	10.7	11.0	11.0	11.0	13.6	136	136	126	455.4
Copper feed grade	%	0.4	0.5	0.6	0.5	0.5	0.6	0.4	0.4	0.45
Gold feed grade	g/t	0.27	0.42	0.60	0.51	0.63	0.8	0.4	0.4	0.54
Copper recovery	%	81.1	82.5	83.6	82.1	82.0	83.4	80.7	81.0	82.3
Gold recovery	%	50.6	48.2	52.7	57.3	60.3	70.7	62.9	66.9	65.7
Concentrate produced	kt	123.4	165.1	203.6	152.2	183.9	2,599	1,670	1,728	6,826
Copper in concentrate	kt	33.8	45.7	54.6	42.6	51.5	689	384	397	1,699
Gold in concentrate	koz	46.5	71.5	111.8	104.3	167.4	2,497	1,026	1,122	5,147

Table 5.10 AMC Production Case 1 – Red Chris cost schedule

Cost estimate	Units	FY24	FY25	FY26	FY27	FY28	FY29 to FY38	FY39 to FY48	FY49 to FY68	Total LOM
Operating Costs										
Mining	CAD\$M	133	110	61	35	60	860	975	937	3,171
Processing	CAD\$M	133	137	137	137	169	1,691	1,691	1,566	5,661
G&A	CAD\$M	58	57	57	57	71	707	707	655	2,369
Capital Expenditure										
Growth capital	CAD\$M	417	465	298	132	20	260	479	-	2,071
Sustaining capital	CAD\$M	135	77	61	51	82	392	366	324	1,492
Rehabilitation	CAD\$M	-	-	-	-	-	-	-	176	176

5.10.2 AMC Production Case 2

A summary of AMC Production Case 2 is presented in Table 5.11 and Table 5.12.

The open pit plan included in AMC Production Case 1 is unchanged for this production case.

The underground schedule commences as with AMC Production Case 1 with the sequence of MB1, MB2, and MB3. The ore mining and processing rate has been increased to 15 Mtpa from

Annexure 1. Independent Expert's Report

Newcrest - Independent Technical Specialist's Report

Grant Samuel & Associates Pty Ltd

0223041

FY30 allowing for a 6-year period for completion of mine development and infrastructure installation and ramp-up to full production. This aligns with the Newcrest LOMP.

This case reflects the likely conversion of Mineral Resources and exploration targets that have been identified and are the subject of preliminary studies. It is reasonable to assume that some of the identified Mineral Resources and exploration targets will further extend the life of the project, however, AMC has not considered options to increase production rates as technical work has not been completed in this area. AMC included what it considers a reasonable mine life extension of 15 years in the AMC Production Case 2 at slightly lower overall mined grades.

Table 5.11 AMC Production Case 2 – Red Chris production schedule

Estimate	Units	FY24	FY25	FY26	FY27	FY28	FY29 to FY38	FY39 to FY48	Total LOM
Underground ore mined	Mt	-	0.06	0.81	4.1	9.3	147	151	628
Open pit ore mined	Mt	12.5	18.6	12.5	-	-	-	-	44
Copper grade	%	0.4	0.5	0.6	0.4	0.5	0.6	0.4	0.4
Gold grade	g/t	0.27	0.42	0.60	0.42	0.64	0.76	0.43	0.51
Ore milled	Mt	10.7	11.0	11.0	13.6	13.6	149	150	684
Copper feed grade	%	0.39	0.50	0.59	0.38	0.46	0.60	0.36	0.43
Gold feed grade	g/t	0.27	0.42	0.6	0.42	0.64	0.76	0.43	0.51
Copper recovery	%	81.1	82.5	83.6	81.0	82.0	83.7	80.7	82.0
Gold recovery	%	50.6	48.2	52.7	57.3	60.3	68.1	64.3	66.4
Concentrate produced	kt	122.2	169.5	194.9	150.2	184.5	2,937	1,840	10,032
Copper in concentrate	kt	33.8	45.7	54.6	42.1	51.7	755	424	2,426
Gold in concentrate	koz	46.5	71.6	111.9	105.4	169.5	2,543	1,324	7,419

Notes:

- Production ceases FY70.
- Total LOM is total or average for LOM - FY24 to FY70.
- The values in the table are subject to rounding.
- Concentrate produced is in dry metric tonnes.

Table 5.12 AMC Production Case 2 – Red Chris cost schedule

Cost estimate	Units	FY24	FY25	FY26	FY27	FY28	FY29 to FY38	FY39 to FY48	Total LOM
Operating Costs									
Mining	CAD\$M	133	110	61	37	65	1,038	1,085	4,782
Processing	CAD\$M	133	137	137	169	169	1,852	1,865	8,499
G&A	CAD\$M	58	57	57	71	71	774	779	3,555
Capital Expenditure									
Growth capital	CAD\$M	417	515	338	152	40	260	479	2,201
Sustaining capital	CAD\$M	135	77	61	51	82	412	386	1,938
Rehabilitation	CAD\$M	0	0	0	0	0	0	0	175 ¹

Note: Total Includes Rehabilitation costs FY71 to FY78.

5.11 Key risks and opportunities

5.11.1 Risks

In preparing the ITSR, AMC identified the following material risks to Red Chris.

There is uncertainty in modelling of in situ stress. In situ stress field is an important parameter to determine cave propagation rate. Further stress measurements should be taken to remove the uncertainty. Investigations continue as part of the feasibility study.

Newcrest - Independent Technical Specialist's Report

Grant Samuel & Associates Pty Ltd

0223041

Material properties and constitutive models adopted in cave and subsidence modelling were based on limited data, assumption and previous experience and may be not representative for Red Chris. Cave propagation rate may be lower than expected. Investigations continue as part of the feasibility study.

Failure to achieve planned mill feed

For the period covering FY20 through FY23, the actual mill ore feed was materially (9% less) short of the budget target and total material movement has also been a material shortfall in each of the FY periods (14% less on average). According to Newcrest monthly reports (the material causes for primary crusher feed shortages are issues with ore plugging the primary crusher, delivery ex-pit ore, mill processing challenges with some ores.

As no ore has been treated from the underground operations, there is no assessment of how well the underground ore tonnes and grades will reconcile with the Ore Reserves.

Completion of two pit bottoms at start of freshet

Newcrest is planning to complete the Phase 7 and Phase 5R pit bottoms during March through May 2026, when freshet typically occurs. During the freshet period, a combination of melting snow and fresh precipitation can create material impediments (for example, haul road degradation, elevated pit water levels, and pit wall ravelling/instabilities) to performing planned mining activities if not well managed. Ex-pit ore shortfalls would be made-up with stockpiled ore, which could have a material negative impact on the mill feed grades.

Development risk associated with the development and particularly the ramp-up of a significant caving operation.

Production limitations for a large-scale underground crusher and multiple conveyor system.

5.11.2 Opportunities

In preparing the ITSR, AMC identified the following material opportunities for Red Chris.

Geology and Mineral Resources

Potential exists to continue open pit mining on Red Chris from the Gully Zone. Additional Mineral Resources have the potential to be converted to Ore Reserves for the underground mining project, given the amount of material classified at the Inferred level of confidence that has not been included in the mine plan.

The exploration licence area held by Red Chris contains known porphyry trends that are associated with mineralisation showings. In AMC's opinion, ongoing exploration at Red Chris, has the potential to discover additional copper-gold bearing porphyries that contain economic concentrations of metal mineralisation.

Mining

The mining rate could potentially be scaled up, enabling a lower NSR value to be applied and cashflow to be increased.

Higher grade Exploration Targets on further study could be brought forward in the production schedule to improve project economics. The East Ridge Exploration Target (East Ridge 1 and East Ridge 2) have nominally higher grades than MB2 and MB3.

Newcrest - Independent Technical Specialist's Report

Grant Samuel & Associates Pty Ltd

0223041

6 Brucejack

6.1 Location and background

6.1.1 Location

Brucejack is located approximately 950 north-west of Vancouver and 140 km south-west of Red Chris, Newcrest's other operation in British Columbia, Canada as shown in Figure 6.1.

Figure 6.1 Brucejack location

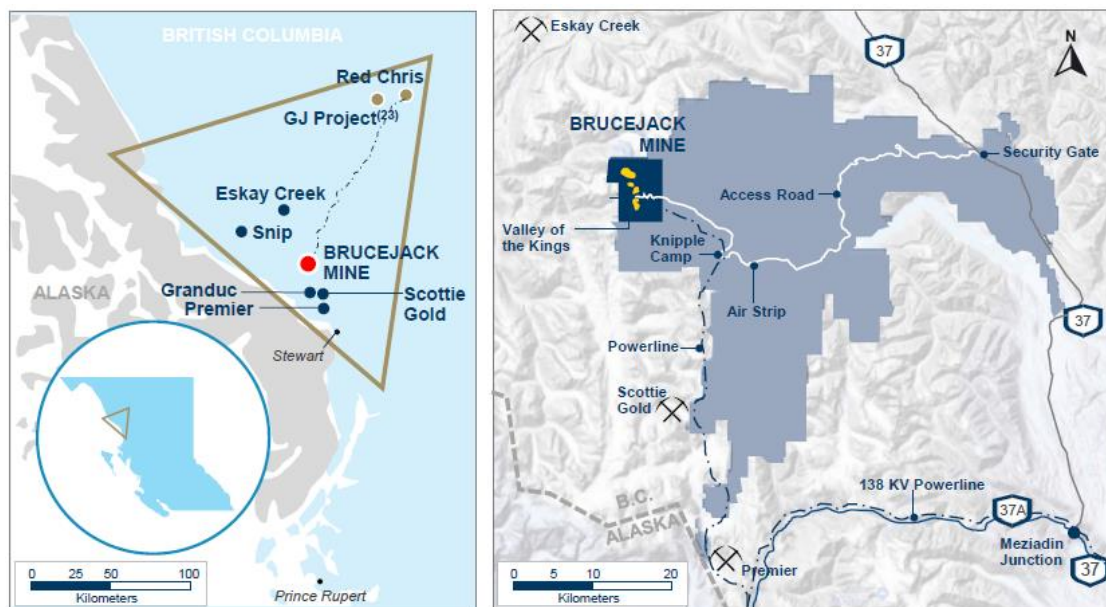

6.1.2 Background

Brucejack mines a gold and silver orebody to produce gold-silver bullion and gold-silver concentrate. Surface construction commenced in September 2015 and was completed by mid-2017. Production commenced in mid-2017 and is ongoing with a remaining mine life currently estimated to be about 15 years with closure scheduled to commence in 2032. Exploration is ongoing.

Newcrest secured its ownership of Brucejack through completion of its acquisition of Pretium Resources Inc. as announced in a Newcrest Market Release dated 9 March 2022.

Brucejack has five components:

- **Mine site area:** Underground mine (longitudinal and transverse long-hole stoping) and related surface facilities including processing plant, waste rock and tailings disposal area, water treatment plant, accommodation camp, fuel storage facilities, overburden stockpiles, quarry water management infrastructure and equipment laydown areas.
- **Brucejack Access Road:** A 75 km gravel road that runs from Highway 37.
- **Brucejack Transmission Line:** a 57 km long line that extends from the mine site to the Bowser River Valley and then southwester to connect with the provincial grid at the Long Lake hydro project near Stewart.
- **Knipple Transfer Area:** Located about km 55 of the Access Road, this area contains a small accommodation camp, laydown areas, waste management facilities, fuel storage, helicopter landing pad and a substation for the transmission line. It facilitates materials

Newcrest - Independent Technical Specialist's Report

Grant Samuel & Associates Pty Ltd

0223041

transfer between the lower all-weather component and glacier portions of the of the Access Road and is the base for road maintenance activities.

- **Bowser Aerodrome:** Air strip, departure facilities and a small accommodation camp.

The core mining area is located at the headwaters of Brucejack Creek and is situated about 1,364 m above sea level. Ice rock and recently deglaciated areas dominate the surficial materials at the mine site and surrounding areas. Glaciers are present to the west, south, and east. The mine site area is either non or sparsely vegetated.

Waste rock and tailings are preferentially disposed of within the underground mine as stope fill. Excess waste rock and tailings is disposed of sub-aqueously into Brucejack Lake ultimately ending up in the Waste Rock Tailings Storage Facility (WRTSF). Other waste streams disposed of within the WRTSF include water treatment effluent and sludge, sewage treatment plant effluent and contact water from surface water management infrastructure. The WRTSF drains into Brucejack Creek and then Sulphurets Creek before entering the Unuk River.

6.1.3 Tenement holdings

Brucejack tenure comprises four MLs and 342 mineral claims. The material tenements are the four MLs, as listed in Table 6.1, along with a special use permit and various licences of occupation.

Infrastructure located outside of the Mining Lease areas is authorised by the British Columbia *Land Act* via 16 Licences of Occupation. A portion of the Brucejack Access Road (72 km from the intersection with Highway 37 until it reaches the Mining Lease boundary) is authorised by a Special Use Permit under the *Forest Practices Code of British Columbia*. Details of these key permits are provided in Table 6.1.

Table 6.1 Brucejack – key land tenure and authorisations

Approval Number	Area (ha)	Tenement Type	Tenement Expiry Date	Status
1038597	53.6	Mining Lease	17/09/2023	Current
1038598	553.6	Mining Lease	17/09/2023	Current
1038599	35.7	Mining Lease	17/09/2023	Current
1038600	107.2	Mining Lease	17/09/2023	Current
S25923	0-72 km BAR	Special Use Permit	NA	
SK920877/6408834	Wildfire Camp	Licence of Occupation	1/08/2045	Current
SK920910/6408838	Bowser Aerodrome	Licence of Occupation	1/08/2045	Current
SK920878/6408836	Knipple Transfer Area	Licence of Occupation	1/08/2045	Current
SK921271/6408828	Communication Tower Knipple	Licence of Occupation	1/08/2045	Current
SK920877/6408827	Communication Tower Brucejack	Licence of Occupation	1/08/2045	Current
SK916625/6408829	Brucejack Transmission Line (south 46 km)	Licence of Occupation	1/06/2021	Renewal pending
SK921296/6408829	Communication Tower Anderson	Licence of Occupation	1/08/2045	Current
SK920881/6408827	Scott Pass Meteorological Station	Licence of Occupation	1/08/2045	Current
SK920921/6408839	Explosives storage area Knipple	Licence of Occupation	1/08/2045	Current
SK920920/6408840	Explosives storage area Bowser	Licence of Occupation	1/08/2045	Current
SK920920/6408835	Bowser Camp	Licence of Occupation	1/08/2045	Current
SK921268/6408830	Communication Tower Mt Shorty	Licence of Occupation	1/08/2045	Current
SK920874/6408831	Avalauncher km 44	Licence of Occupation	1/08/2045	Current
SK920875/6408832	Avalauncher km 58	Licence of Occupation	1/08/2045	Current

Annexure 1. Independent Expert's Report

Newcrest - Independent Technical Specialist's Report

Grant Samuel & Associates Pty Ltd

0223041

Approval Number	Area (ha)	Tenement Type	Tenement Expiry Date	Status
SK930673/6408833	Avalauncher km 59	Licence of Occupation	1/08/2045	Current
SK921748/6408859	Communication Tower Wildfire	Licence of Occupation	1/08/2045	Current

6.1.4 Operational history

Table 6.2 Brucejack historical mining and processing data

Year	Units	FY22	FY23
Ore mined	Mt	0.47	1.32
Total material mined	Mt	0.75	2.05
Total material moved	Mt	-	-
Gold grade mined	g/t	7.26	6.78
Ore processed	Mt	0.46	1.35
Gold feed grade	g/t	7.95	6.82
Gold recovery	%	96.9	96.7
Gold produced	koz	114	286

Source: Various monthly reports, Newcrest public documents and company advice.
Note: Newcrest ownership from April 2022.

6.2 Site Visit

During AMC's site visit, key aspects of the operation were inspected including the underground workings, the processing plant and the core handling and storage area. Discussions were also held with senior members of the Brucejack operating team.

6.3 Geology and Mineral Resources

6.3.1 Geology

The Brucejack deposit has been described by Newcrest and others as hosted in Lower to Middle Jurassic Hazelton Group volcanic and sedimentary rocks that form the Stikinia (or Stikine) tectonic terrane of the Sulphurets mineral district.

The Brucejack deposit is interpreted as being a deformed, porphyry-related transitional to intermediate sulphidation epithermal, high-grade gold-silver deposit, similar in nature to the deposits mined in the southwest Pacific Rim. Mineralisation in the deposit is structurally controlled, with high-grade, epithermal, gold mineralisation (primarily as electrum) being associated with steeply dipping, east-trending quartz-carbonate veins. The high-grade veins overprint, low-grade, intrusion-related, gold mineralisation.

The Brucejack deposit is crosscut by late-stage andesite-basaltic andesite amygdaloidal dykes, which truncate all mineralized veins, and which are crosscut by late stage (post-mineralization) quartz-calcite veins.

Currently, two primary mining areas are defined, namely the Valley of the Kings (VOK) and the West Zone (WZ). The areas have distinctive metal zonation characteristics. The VOK is gold rich, whereas the WZ is silver rich.

A simplified geological map of the Brucejack deposit is presented in Figure 6.2.

Newcrest - Independent Technical Specialist's Report

Grant Samuel & Associates Pty Ltd

0223041

Figure 6.2 Simplified geology of Brucejack - main mineralised zones

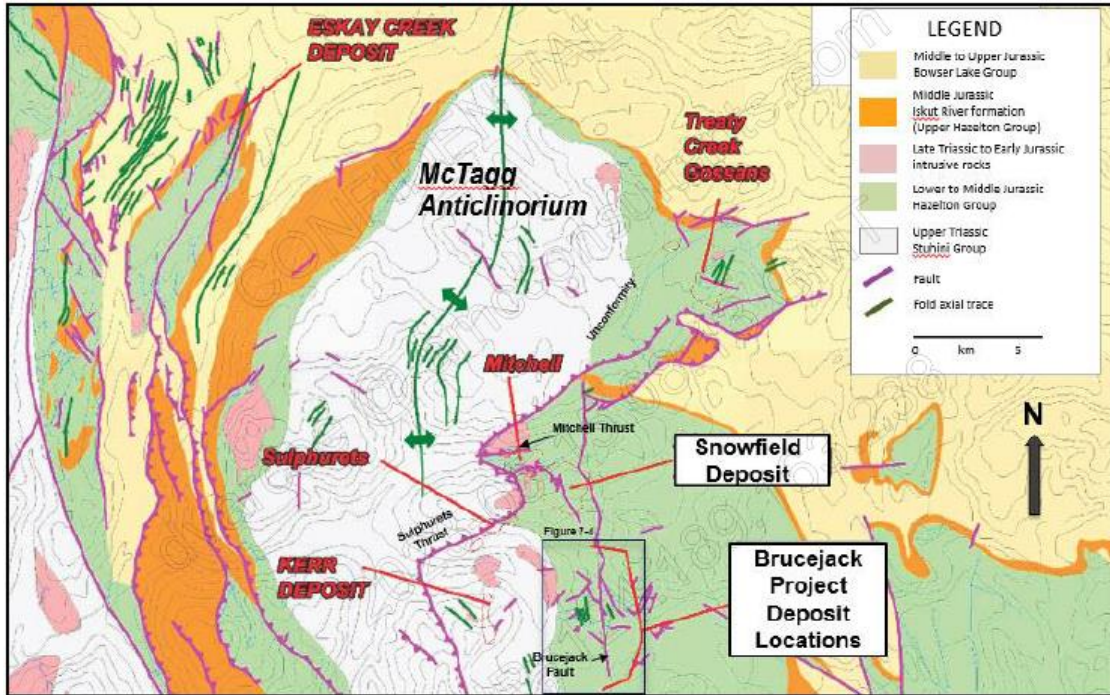

The VOK has a strike length of 1,200 m (east-west), a 700 m north-south extent, and is currently defined to 650 m in depth. The VOK remains open to the east, west, and at depth. The WZ has a defined strike of 590 m in a northwest orientation, 560 m across strike, and is currently defined to a depth of 650 m in depth. Like the VOK, the WZ remains open to the northwest, southeast, and at depth to the northeast (Figure 6.3).

Figure 6.3 VOK to West Zone geological section

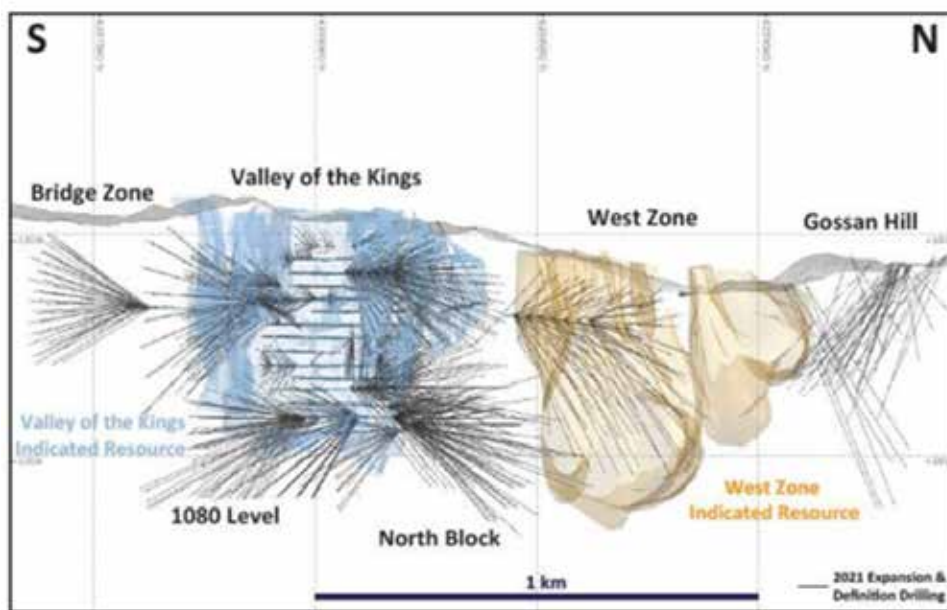

Annexure 1. Independent Expert's Report

Newcrest - Independent Technical Specialist's Report

Grant Samuel & Associates Pty Ltd

0223041

More than 40 mineralization showings, at least eight of which are currently considered as mineralized zones (for example, Bridge Zone, Waterloo Zone, Flow Dome Zone, Gossan Hill Zone, Shore Zone, SG Zone, Golden Marmot Zone, and Hanging Glacier Zone), are known to occur on the Brucejack Property, making it highly prospective.

6.3.2 Mineral Resources and estimation

The Brucejack Mineral Resource estimate at 30 June 2023 is shown in Table 6.3.

The Brucejack Mineral Resources estimate includes an additional 6,330 DD holes comprising 1,033,504 m and 14, 744 RC holes comprising 357, 561 m.

The geological modelling and estimation process for VOK and WZ are similar, with geological modelling being undertaken using Leapfrog™ software (various versions) and estimation and reporting being undertaken using Maptek Vulcan™ software. Geological models are produced for lithological and structural features (faults and dykes), with mineralisation systems being defined by four main structural trend domains.

The Mineral Resources for Brucejack have been estimated using a NSR cut-off value of CAD\$ 246/t milled to demonstrate RPEEE as referred to in the JORC Code.

Table 6.3 Brucejack Mineral Resources as at 30 June 2023

Classification	Tonnes Mt (Dry)	Grade		Contained Metal	
		Au (g/t)	Ag (g/t)	Au (Moz)	Ag (Moz)
Indicated	19	13	34	8.2	21
Inferred	9.6	13	13	4.0	4.1

Note: All data reported is on a 100% asset basis, Newcrest attributable share 100%.

AMC notes that the values in the table are subject to rounding, all tonnages are estimated and reported on a dry tonnage basis, the Mineral Resource estimate does not account for mining recovery or mining dilution, and Mineral Resources are inclusive of the Ore Reserves.

6.3.3 Data collection

DD has been the primary tool used in the exploration of the Brucejack deposit, both surface and underground. RC is currently used for grade control purposes and has now been used by Newcrest as part of the current Mineral Resource estimate update. Paired analysis was used by Newcrest to confirm that the RC data could be used for the estimate. Sampling is undertaken at approximately 1.5 m lengths for DD holes (with geological changes being honoured) and 1.5 m to 3 m for RC holes.

All drillhole collar locations are surveyed by Brucejack's mine survey team prior to drilling and are re-surveyed post-drilling. Downhole surveys are completed at nominal 25 to 50 m intervals using a Reflex EZ single shot with a Reflex EZ Gyro being used for the deep exploration holes.

Drillhole survey data is validated by the database manager, with 3D checks being undertaken in Maptek Vulcan™ mining software. Core logging is conducted in a well-lit core facility with appropriately labelled core boxes. Logging data is directly captured using GeoSpark core logging software. All data has been transferred to acQuire and is now stored in an acQuire database. Data validation is undertaken by the database manager.

Core recovery is high, with over 98% core recovery being achieved, all core is logged and photographed in a wet state.

Depending on the where the DD hole is drilled and what the requirements are, the core may be oriented or unoriented. Given the nature of the mineralisation whole core assaying is generally

Newcrest - Independent Technical Specialist's Report

Grant Samuel & Associates Pty Ltd

0223041

undertaken, using an average sample length of 2 m, this length will vary due to geological requirements, that is, a lithological boundary. ALS Vancouver have been the primary analytical laboratory used by Brucejack since 2009.

All samples are assayed for gold and silver as well as for an additional 32 elements using a for acid digestion followed by ICP-OES determination. Gold is assayed using fire assay using a 50g aliquot, with AA finish. If values assay higher than 18 g/t, then a gravimetric finish is undertaken.

Prior to Q2, 2018, 30 g aliquots were used with a combination of conventional and screen fire assay methods.

Silver over-limit concentrations are analysed using 4 acid digest with an ICP-OES finish up to 1,500 g/t, after which assaying was undertaken using fire assay with 30 g aliquots.

AMC considers for methodologies and procedures undertaken at Brucejack are fit for purpose.

6.3.4 Bulk density

The density measuring (specific gravity, SG) methodology was changed in 2022, with a move from ALS determining SG via pycnometer in the laboratory, to whole core SG measurement, on site, using the water displacement method. The recent Mineral Resource estimate excluded all density measurements derived from pycnometer measurements. Currently the SG data base comprises of 3,730 SG measurements for VOK and 334 SG measurements for WZ.

6.3.5 Data management

Since 2011, all exploration data has been captured using Geospark™ data base software. All data has been transferred to acQuire and is now stored in an acQuire database, where it is independently validated by the database manager, in addition statistical and spatial validation checks are completed during the geological modelling and estimation processes.

Validation of historical data included re-assaying of historical drillhole pulps, with various data base and primary data validation exercises having been undertaken at by the current and prior owners. These exercises have resulted in Brucejack accepting these historical assay data and geological records for use in the current estimation process.

During the site visit AMC observed that the core handling and storage facility was well kept and equipped. During the site visit AMC observed Brucejack geologists logging and photographing DD core. However, no sample selection was observed. Based on AMC's observations during the site visit, discussions with Brucejack staff, and a review of the procedures provided, AMC is of the opinion that the procedures and practices employed by Brucejack are in line with current industry standard practice.

6.3.6 Data management processing and checks

Brucejack has:

- Historical data was captured by a third-party contractor and has undergone various validation checks by independent third parties as well as the various owners of Brucejack.
- Used the same drilling contractor since 2013 and standard drilling methods are used.
- All drilling is the responsibility of the Exploration team, thus ensuring consistency. Manual and automated processes for inputting data from sampling and logging into the database.
- All data is validated by the database management team as well as being spatially validated in 3D using Leapfrog™ software.
- ALS Vancouver has been used since 2009, interlaboratory (round robin) checks are undertaken.

Newcrest - Independent Technical Specialist's Report

Grant Samuel & Associates Pty Ltd

0223041

AMC are of the opinion that the data management and validation systems used at Brucejack are in line with current industry standard practice.

6.3.7 Data quality assurance and quality control (QA/QC)

Monitoring of assay quality control has been in place since 2009 (Silver Standard) and was continued and improved by Pretium (2009 to 2021). Newcrest has maintained and improved the QA/QC practices since acquiring Brucejack.

Assay QA/QC protocols are in place that included certified reference material, blanks, field duplicates, pulp duplicates and coarse duplicate assays. QA/QC submission rates are in line or exceed accepted industry insertion rates. CRMs and coarse blanks are alternatively inserted into the sample stream at an insertion ratio of 1:10. Crush and pulp duplicates are inserted at a ratio of 1:20. Secondary (umpire laboratory) checks are undertaken for 5% of all samples selected that have a gold value greater than 0.5 g/t.

AMC is of the opinion that the QA/QC process is robust, and the assay results may be used in a Mineral Resource estimate.

6.3.8 Mineral Resource estimation process

The geological modelling and estimation process followed for VOK and WZ is similar with fault, dyke and lithological models being created using Leapfrog™. Mineralisation domains are defined by four main structural trend domains based on the extent and orientation of vein systems.

The wire frames are then exported to Vulcan.

A 5 m composite length is used for both RC and DD holes, with residuals being redistributed, in order to align with the chosen block size of 5 m x 5 m x 5 m. No rotation is applied to the block model.

Gold and silver are treated as independent variables and are estimated using MIK for gold and OK for silver.

Estimation was undertaken in a single pass, using an isotropic search radius of 50 m. A minimum of 20 samples and a maximum of 32 samples was used for MIK estimation. A maximum of four composites per hole, with a maximum of five composites were used. Where estimation was undertaken using OK, the minimum and maximum number of samples was varied per domain and per element, varying from 10 to 12 (minimum number of samples) to 24 to 30 (maximum number of samples). A maximum number of four composites per hole were used.

Estimation was directly into 5 m x 5 m x 5 m blocks using a 2 x 2 x 2 discretisation. Densities are assigned using an average per lithology.

AMC is of the opinion that the estimation methodology used for Brucejack is appropriate given the style of mineralisation present.

6.3.9 Grade validation

During the Mineral Resource estimation process, data is checked and validated when it is imported into Vulcan and Leapfrog. Composites are visually reviewed in 3D to confirm domains are assigned correctly. This included computational checks to confirm calculations are correct. Codes and composites are checked against domain boundaries and compositing.

Following estimation, Newcrest undertakes estimation validation of the block model estimate. This includes:

- Visual validation of block grades against drillholes.
- Statistical comparisons between grade and block data.
- Swath plots of drillhole data and block models.

Newcrest - Independent Technical Specialist's Report

Grant Samuel & Associates Pty Ltd

0223041

6.3.10 Classification criteria

AMC considers the cut-off applied to be reasonable and is sufficient for the Brucejack Mineral Resource estimate.

6.3.11 Mineral Resource estimate reporting

The Brucejack Mineral Resource estimate is classified and reported as Indicated and Inferred in accordance with the JORC Code based on:

- The quality of the data.
- Drill density.
- Continuity of geology and grade.
- Geological model validation.
- Reconciliation against production data.

AMC considers the approach to the Brucejack Mineral Resource estimate classification to be reasonable.

6.3.12 Estimation summary

AMC has independently reviewed the block model estimations as a global confirmation of grade for the Brucejack Mineral Resource estimate, using data supplied by Newcrest. AMC replicated the estimate as reported by Newcrest, allowing for rounding by Newcrest and the use of different software packages. An independent consultant conducted a full audit of the resource estimate in FY23 and concluded that there were no material issues.

AMC viewed the drillholes against the block model and satisfied itself that the distribution of geology and grade is represented by the block model.

6.3.13 Conclusions

AMC's conclusions regarding the Mineral Resources estimate are:

- AMC considers that the Brucejack Mineral Resources classifications, given the complexity of the geology are reasonable.
- The estimates are appropriately classified as Indicated and Inferred Mineral Resources in accordance with the JORC Code. AMC agrees with the Brucejack Mineral Resources estimate classification.
- AMC has used the resource models provided by Newcrest to test whether the tonnes, grades, and classifications reported for the Mineral Resources estimate can be reproduced. AMC confirmed this to be the case.
- In AMC's opinion, the Brucejack Mineral Resources estimates is an appropriate basis for Ore Reserve estimation.

6.3.14 Exploration and resource potential

The Brucejack property remains prospective, both within the immediate VOK and WZ areas, as extensions to the known mineralisation trends, which has been confirmed via underground exploration.

Near mine and brownfields extensions, that are considered by Newcrest to be opportunities are:

- VOK extensions.
- VOK East.
- WZ extensions
- WZ North.
- Shore zone.

Newcrest - Independent Technical Specialist's Report

Grant Samuel & Associates Pty Ltd

0223041

Additional exploration potential exists on the property and is discussed in section 9 of this ITSR.

AMC has reviewed the data and reports provided by Newcrest and are in agreement that the potential for Mineral Resource replacement as well as increasing the size of the Mineral Resource is high and that the targets identified by Newcrest and the risk ratings assigned are reasonable.

6.4 Geotechnical investigations

6.4.1 Data collection

Historical data from geological and geotechnical core logging of selected drillholes and geotechnical mapping of underground exposures have been used by Brucejack to develop the geotechnical model and underground geotechnical design parameters. The information used as a basis of rock mass characterization and underground geotechnical design includes:

- Over 110,000 m of geological and geotechnical core logging.
- Discontinuity orientation data collected from structural logging of oriented cores and optical and acoustical televiwer televiwer survey. The discontinuity data is complemented with underground structural mapping portal, ramp, exploration drift and 1350 level.
- Laboratory testing of intact rocks and discontinuity surfaces. Tests completed include point load index, uniaxial compressive strength, Brazilian tensile strength, triaxial compressive strength, and small-scale direct shear.

Major data gap identified for rock mass characterization and underground geotechnical design is that no in situ stress measurements were taken at Brucejack. In situ stress conditions and related mining induced stress changes in response to mine design and sequencing may have a significant impact on excavation stability, particularly at greater depth.

The geotechnical investigation has included essential activities. The work which has been carried out in accordance with industry-standard methods is considered to be sound. Risks associated with data gaps to the underground geotechnical design and the mining plan can be mitigated with further investigation. Stress measurements are being planned to be taken later in 2023.

6.4.2 Geotechnical characterization

The Brucejack property is largely underlain by volcano-sedimentary rocks of the Lower Jurassic Hazelton Group. These rocks unconformably overlie volcanic arc sedimentary rocks of the Upper Triassic Stuhini Group along the western-most part of the Brucejack project area. The rocks are variably altered and deformed, with zones of intense quartz-sericite-pyrite (phyllic) alteration being associated with increased deformation due to preferential strain partitioning in sericite-rich zones.

Ten mineralized zones have been recognized on the Brucejack project area, extending from the Hanging Glacier Zone in the north to the Bridge Zone in the south. Five of these zones have been explored in some detail, they are WZ, VOK, Bridge Zone, Gossan Hill Zone, and Shore Zone. Mining at Brucejack is focused on VOK and WZ.

The geotechnical domains at Brucejack were grouped based on rock properties and discontinuity characteristics. Each geotechnical domain is estimated with consideration of lithology and alteration, intact rock properties, blockiness, discontinuity conditions and fault disturbed zones.

Major fault structures have been located and investigated, 3D major structure model has been developed with four fault zones being known to intersect the mining footprint: the Brucejack fault zone, Rainy Fault, VOK Main Fault and the Upper Thrust Fault. The characteristics (orientation, width, rock mass condition) for the four fault zones have been evaluated. Discontinuity sets have been analysed for production areas in VOK based on oriented core measurements, televiwer surveys and underground mapping.

Newcrest - Independent Technical Specialist's Report

Grant Samuel & Associates Pty Ltd

0223041

Laboratory strength tests results shows that intact rock at Brucejack is typically medium strong to very strong.

Two rock mass quality classification are adopted at Brucejack: Q-system, and RMR₇₆ systems. Results of Q-system were used for empirical assessments of stope dimensioning. Rock mass quality has been assessed by geotechnical domains to account for regional variation. Typical rock mass condition across the geotechnical domain ranges from "Fair" to "Very Good" in terms of RMR₇₆.

Hoek- Brown intact rock strength parameters for each domain were derived based on strength tests data and GSI (equivalent to RMR₇₆).

6.4.3 Stope dimensions and dilution estimates

The empirical stability graph method was used to assess stable stope dimensions for individual stopes. And the equivalent linear overbreak/slough (ELOS) method was used to estimate the stope HW/FW dilution. In the initial assessment conducted, rock mass qualities were over-estimated for base case and conservative case, which were not representative of ground conditions encountered. which resulted in over-optimistic allowable stope lengths being estimated. Based on actual rock mass condition commonly encountered and stope performance, the guidelines of stable stope dimensions and associated ELOS were revised and presented in Table 6.4

Table 6.4 Stope dimension and dilution guidelines

Rock Mass Conditions	Maximum Stope Dimension (m)	ELOS (m)
Fair to Good (RMR ₇₆ > 40)	15 W x 30 H x 15 to 40 L	<1.0
Poor to Very Poor (RMR ₇₆ < 40)	15 W x 30 H x 15 L	1.0-3.0

Both the stability graph method and the ELOS approaches are empirical methods based on experience and case studies; they do not account for all factors (such as fault, drilling and blasting) known to affect the stability of, and dilution from stope walls. The assessment results rely on input parameters, and hence suffer from their intrinsic limitations. Reduced stability is likely encountered when stoping in the fault zones, and excessive wall overbreak is expected when the fault structures are parallel or sub-parallel to stope walls. Blast induced damage is not considered in the empirical assessment. Dilution may be encountered from formulation of unstable blocks or wedges, or from rock mass damage induced by poor drilling and blasting practices, or from delayed mucking and lengthy exposure time. These limitations must be well recognised.

It is observed during site visit that stope performance is somehow unpredictable, such as

- Stope in good rock mass condition experienced higher or excessive overbreak in back and walls than expected.
- A stope with presence of fault structure parallel to stope wall experienced significant overbreak.
- Stope in poor rock mass condition experience lower overbreak than expected.

Likely causes of overbreak and underbreak include:

- Poor drilling and blasting practice and/or
- Rock mass quality or adverse structures under-estimated.

As such, AMC recommends that:

- A review of stable stope dimensions should be undertaken following stope development and geotechnical mapping of the area.

Newcrest - Independent Technical Specialist's Report

Grant Samuel & Associates Pty Ltd

0223041

- Brucejack focus on drilling accuracy and blasting efficiency to minimise damage to development and stope walls, and timely mucking and backfilling to reduce unplanned dilution.
- Brucejack implement a stope reconciliation process to assess the geology, planning, mining, rock mechanics, and operations execution and implementation and to identify root cause of overbreak and underbreak.

6.4.4 Ground support

Ground support standard has been developed using industry standard approach based on service life and use of excavations and revised based on operational considerations. The support design appears to be reasonable and adequate for anticipated conditions.

6.4.5 Geotechnical risk and management

AMC notes that the key geotechnical risks identified are low and summarized as follows:

- There is uncertainty in in situ stress as no stress measurements have been taken. This may affect excavation responses thus impacting ground support and stope performance and dilution particularly mining at depths.
- Higher dilution and increased instability could be encountered if poorer rock mass conditions are encountered with current stope dimension guideline.

These issues impose risks as they could impact on mining conditions, support requirements, production rates and costs. However, given their nature, these risks can be mitigated by further geotechnical investigation, stress measurement at depths, and appropriate design modifications.

6.5 Mining operations and Ore Reserves

6.5.1 Current mining operations

The Brucejack mine is designed to support 3,800 tpd of Au-Ag ore production sourced from transverse (dominant method) longitudinal and transverse long-hole open stoping, with twelve stopes active at a time. The mine is accessed via declines, of which 800 m contains a mill conveyance system, with portals located near the concentrator. Mining is performed by a contractor, which also supplies the majority of the mining equipment with bulk material movement being done by LHDs (8 t and 10 t) and electric Z50 trucks (40 t-45 t). Figure 6.4 provides an overview of the mine site in relation to the underground workings.

Sublevels are generally spaced at 30 m (vertical) and are accessed off the decline. Drifts are generally 5.5 x 5.5 m in size and are developed using jumbos and bolters. Level development is generally in the footwall of the orebody and follows the mineralization trend. Transverse long-hole open stoping uses a primary/secondary overall bottom-up extraction sequence, with no post-mining permanent pillars being required. Stopes are backfilled using a combination of paste and run-of-mine waste rock. Where possible waste is used for backfill (secondary stopes) with surplus material being trucked to the surface and deposited in Brucejack Lake. Figure 6.5 illustrates the underground layout and the stopes in the 2020 Ore Reserve.

Drifts are supported with grouted rebar and welded wire mesh in ramps and level accesses and infrastructure. Friction bolts and welded wire mesh are used to secure the ore cross cuts, and cablebolts and connectable Super Swellex bolts are employed in the stope top/bottom cuts.

Newcrest - Independent Technical Specialist's Report

Grant Samuel & Associates Pty Ltd

0223041

Figure 6.4 Plan view the Brucejack site in relation to underground workings.

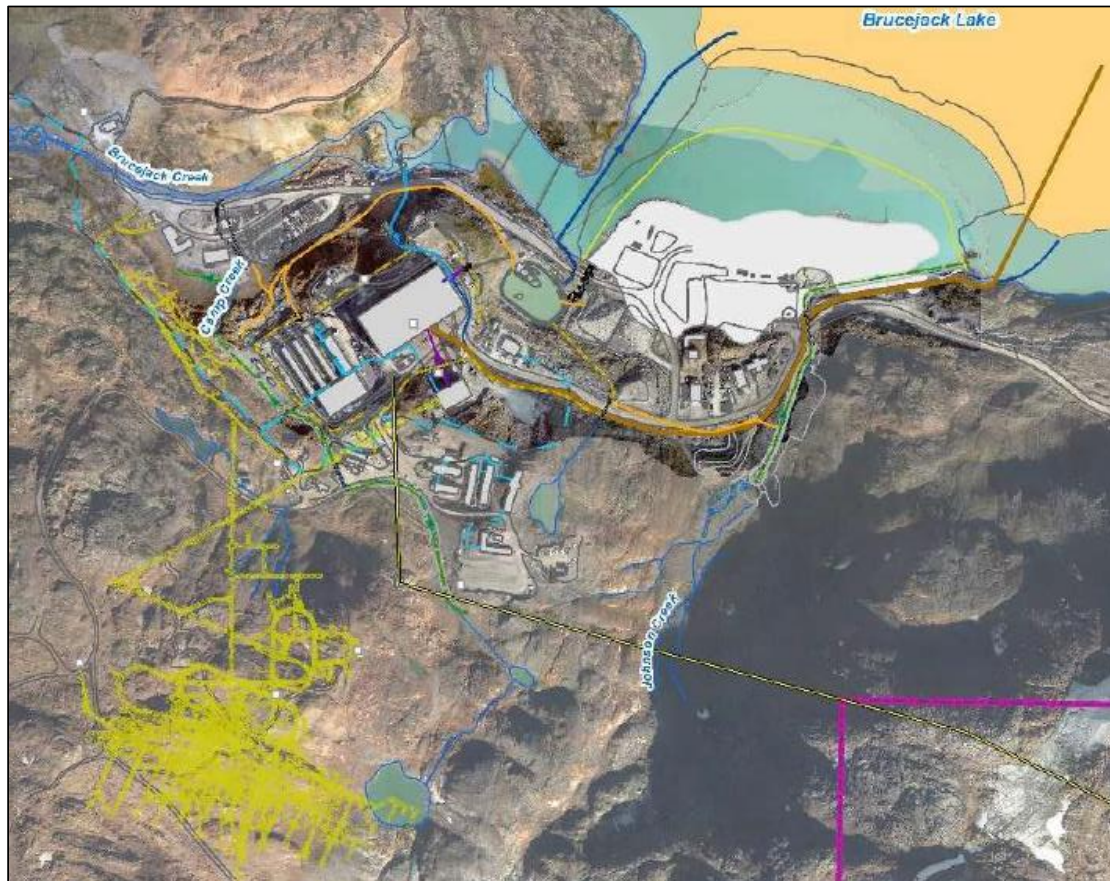

Underground ore handling is done by trucks, which tip onto a grizzly with rock break and ore flows through a surge bin into a jaw crusher and onto the conveyed to surface. Paste is created using unclassified tailings and binder in a surface plant and distributed underground using a surface pump (for WZ and Lower VOK Zone) and an and a booster pump for reticulating paste to the Upper VOK zone.

Mine ventilation is accomplished with a positive pressure system that uses surface mounted main fans (2.4 m, 600 kW) located at each of the two portals forcing air underground, which is exhausted to surface via dedicated raises. An intake air pre-heating system is installed on each of the main fans to ensure intake air is above freezing when it enters the mine.

Underground water in the main sump is pumped out of the mine via centrifugal pumps (2), as-is (no settling or slimes removed) to the surface where it goes through a clarifying and treatment process.

The underground emergency safety system includes eight refuge stations, stench gas system, mine phones and mobile radios with egress via the declines.

6.5.2 Future mine expansion

Newcrest has undertaken a debottlenecking concept study for Brucejack, with the focus being a two-phased 20% to 30% increase in throughput to reach a rate of 4,950 tpd. Improvements are targeted at mining operations and low capital cost and complexity mill upgrades. The overall recommendation was to commence mine operational improvements immediately, mill upgrades

Newcrest - Independent Technical Specialist's Report

Grant Samuel & Associates Pty Ltd

0223041

to increase production to a sustainable 4,200 tpd and undertake the next level of study and 4,950 tpd permitting activities.

Newcrest has studied ore sorting, which is reported to concentrate about 80% of the Au into 1.0% of the feed mass or 90% of the Au into 10% to 20% of the feed mass for sorting. Newcrest is in the process of a full-scale trial deployment that is targeted to be complete in the first half of 2024, with the results of the trial used to determine the best way of deploying ore sorting at Brucejack.

6.5.3 Ore Reserves and estimation process

The Brucejack Ore Reserves as at 30 June 2023 are presented in Table 6.5.

The Ore Reserves are estimated using the resource model that is coded with a total NSR (cut-off of CAD\$246/t milled) value for every model block. Using this model and minable shape optimizer software, three-dimensional stope shapes are developed, which were then individually refined as required. Mining areas assessed to be economically viable were included in the mine plan.

Brucejack historically applied a mine call factor (MCF) to account for the local overestimation by resource and reserve models in operating areas. This matter was addressed in the 2023 resource and reserve models.

Table 6.5 Brucejack Ore Reserves as at 30 June 2023

Classification	Tonnes Mt (Dry)	Grade		Contained Metal	
		Au (g/t)	Ag (g/t)	Au (Moz)	Ag (Moz)
Probable	14	8.4	32	3.7	14

Notes:

- All data reported is on a 100% asset basis.
- Initial Ore Reserve estimate for Newcrest Mining Limited.

Ore Reserves are based on CAD\$246/t milled cut-off based on a US\$1,300/oz Au price, US\$18/oz Ag price, and a CAD\$1.00:US0.77 rate. They are inclusive of mining dilution and mining recovery.

An audit of the Ore Reserve was undertaken in FY23 by an independent consultant and no major issues were identified.

Spatial location of the Ore Reserves is illustrated in Figure 6.5 below.

Newcrest - Independent Technical Specialist's Report

Grant Samuel & Associates Pty Ltd

0223041

Figure 6.5 Spatial location of the Brucejack Ore Reserves

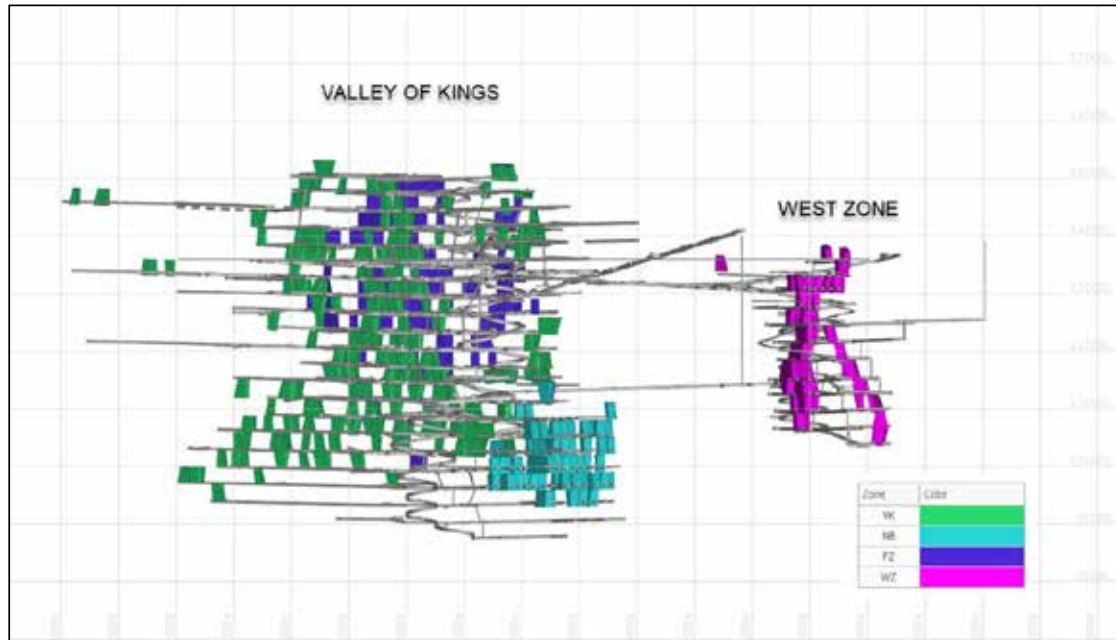

Newcrest notes that estimation of gold grades at Brucejack is difficult.

6.5.4 Resource development and future mining concepts

No material changes to the mining method or extraction sequencing have been proposed.

6.6 Mineral processing

The Brucejack processing plant commenced operation in May 2017, using a conventional gold plant flowsheet consisting of gravity concentration to recover coarse gold and silver particles and bulk sulphide flotation to recover fine gold and silver in conjunction with sulphide minerals.

Design capacity was 1.0 Mtpa – achieved with a feed rate of 2,700 tpd. Overall time utilisation of 92% is included in the daily average rate.

In 2018, the throughput capacity was increased to 1.39 Mtpa – achieved with a feed rate of 3,800 tpd.

In 2020, further expansion and improvement of the plant resulted in increased feed rate to 4,065 tpd which increased throughput to 1.48 Mtpa. The current permitted production rate is 3,800 tpd over the year, with shortfall in any year carried over to future years. As a result, the FY24 budget has been set at just under 4,000 tpd.

Newcrest completed a concept study in November 2022 to further debottleneck the plant and realise a feed rate of 4,950 tpd (1.81 Mtpa). The study was completed with the assistance of Metso Outotec who provided process modelling and engineering services for the proposed circuit modifications. Newcrest intends to increase feed rate in three steps as follows:

- 4,200 tpd – minor capital expenditure while the debottlenecking PFS and FS are conducted
- 4,600 tpd – by FY25
- 4,950 tpd – by FY26

Newcrest - Independent Technical Specialist's Report

Grant Samuel & Associates Pty Ltd

0223041

6.6.1 Processing plant description

The flowsheet consists of the following basic circuits:

- Primary crusher – located underground.
- Primary grinding - SAG mill/ball mill/pebble crusher.
- Gravity concentration – within the grinding closed circuit.
- Gold room – to smelt and pour Au/Ag doré bars for shipment off-site.
- Rougher/scavenger flotation – with hydrocyclone overflow at P₈₀ 100 µm.
- Three-stage cleaner flotation of rougher plus scavenger concentrate.
- Flotation concentrate dewatering – with truck transport of filter cake from site.
- Flotation tailings dewatering – with storage under water in Brucejack Lake, or for use as feed to paste backfill plant.

The debottlenecked flowsheet is shown in Figure 6.6. Additional high-efficiency Jameson flotation cells have been added to the rougher circuit and additional cleaner flotation capacity has been provided.

Figure 6.6 Brucejack plant - debottlenecked flowsheet (2022)

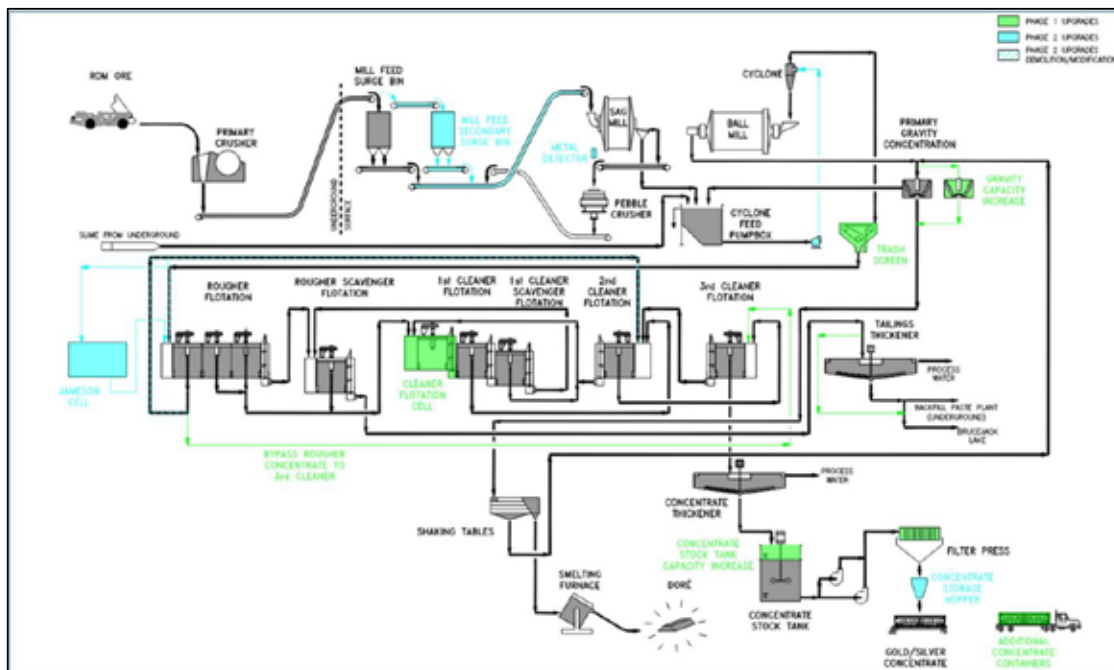

6.6.2 Metal recovery and concentrate grade

Gold recovery has been on plan since acquisition of Brucejack. FY22 Actual was 96.9% versus Budget of 96.7%. FY23 Actual was 96.7% versus Budget of 96.7%. Silver recovery is above budget in FY23 (YTD to May 2023) actual was 86.2% versus Budget of 84.2%.

Gold production for FY23 was 286 koz versus the budget of 347 koz. Losses to plan were primarily due to the safety shutdown-related throughput issues and lower than planned feed grade (6.82 g/t Au versus 8.06 g/t Au) due to milling of lower grade available ore during inclement weather.

Newcrest - Independent Technical Specialist's Report

Grant Samuel & Associates Pty Ltd

0223041

6.6.3 Concentrate transport and marketing

Concentrate is filtered to 8% moisture content and transported off site by road in sealed bulk containers. Containers are taken to the Knipple Transfer Station and then to the Port of Stewart, BC where it is reloaded in bulk containers for ocean transport to international customers.

6.6.4 Tailings storage

Tailings are thickened and pumped to the paste backfill plant or to the Brucejack Lake tailings storage facility. Brucejack Lake has sufficient capacity for the life of the mine.

6.6.5 Future ore processing plans

The Newcrest LOMP has a throughput of 1.4 Mtpa (3,800 tpd) for FY23 and FY24 and 1.8 Mtpa (4,950 tpd) beginning with FY26. This production rate is aligned with results derived from a debottlenecking study completed in November 2022. Capital expenditure totalling CAD\$105M has been allocated in FY24 to FY26 for the debottlenecking project.

Gold recovery in the Newcrest LOMP ranges from 96.8% to 97.0% which is in line with recent actual plant performance.

AMC finds future processing plans to be reasonable and supported by recent actual plant performance and relevant concept-level studies. The outcomes of the concept-level Debottlenecking Study will require confirmation at pre-feasibility and feasibility study levels of accuracy.

6.7 Site infrastructure and services

6.7.1 Power supply

A 138 kV overhead power supply line was constructed in 2016 to 2017 from Long Lake Hydro Station to a sub-station at Knipple. Two transformers step down from 138kV to 69 kV at Knipple. Each unit is capable of supplying the full Brucejack load. The two 69 kV lines follow the mine access road to Brucejack (see Figure 6.7).

6.7.2 Water supply

Fresh water for fire and emergency services, mill motor cooling and lubrication systems, pump gland water systems, reagent make-up and process water make-up is provided from Brucejack Lake.

Potable water for the site is supplied from on-site wells.

6.7.3 Other infrastructure

Figure 6.7 shows the general regional layout of the Brucejack mine – specifically access roads and power lines.

Newcrest - Independent Technical Specialist's Report

Grant Samuel & Associates Pty Ltd

0223041

Figure 6.7 Brucejack infrastructure – regional layout

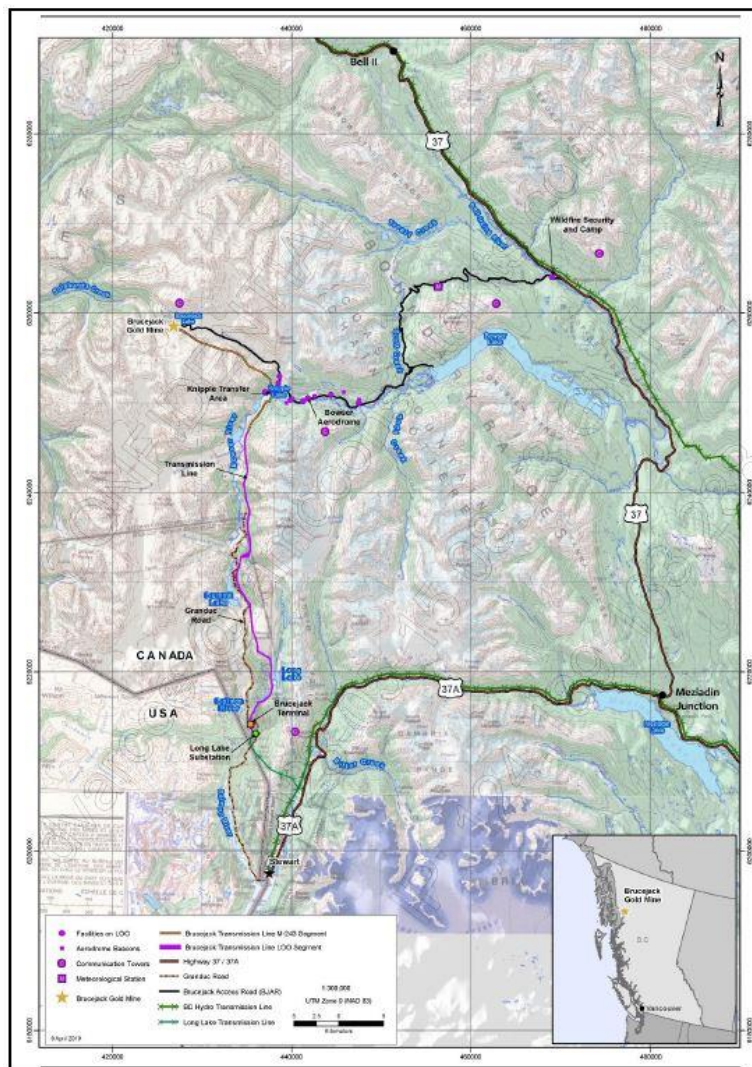

Source: Pretivm (2019)

6.8 Environmental, social, and permitting

6.8.1 Environmental and regulatory approvals background

Brucejack received provincial Environmental Assessment Certificate (M15-01) on 26 March 2015 and a Federal Canadian Environmental Assessment Act Decision Statement on 30 July 2015. All the various provincial and Federal permits required to construct, operate and decommission the mine were received in 2015.

A number of amendments to M15-01 have been obtained over the life of Brucejack to ensure conformance of constructed infrastructure with certificate requirements, allowance for increased production throughput to 3,800 tpd and expansion of project boundaries. A

An amendment to Mines Act Permit for the Mine Plan and Reclamation Program (M-243) was obtained in 2022 to increase the permitted mine area to 659.3 ha.

Newcrest - Independent Technical Specialist's Report

Grant Samuel & Associates Pty Ltd

0223041

Amendments to Discharge Permit PE-107835 have been made during the Brucejack life. The current permit authorises thickened slurry discharge commensurate with the 3,800 tpd operation.

Amendments to Discharge Permit PE-107025 have been made during the Brucejack life. The current permit authorises mine related discharges to air and ash to ground.

6.8.2 Environmental and social assessments, control, and management

An integrated health, safety and environmental programme has been implemented with the objective of achieving net zero harm. A gap assessment between Newcrest HSEC requirements and Brucejack systems has been undertaken and an Action Plan developed to address gaps.

Brucejack has an Environmental Management System that has been approved by regulatory authorities as part of the approvals process (M15-01). Brucejack has 31 Management Plans, 21 of which are required under Schedule B of M15-01 and 10 required through other provincial authorisations. These are subject to regular review with changes documented as part of annual regulatory reporting processes. Last review was identified as being in early 2022 as part of the march 2022 regulatory annual report submission.

Compliance with regulatory requirements is assessed annually and outcomes documented in the annual report to regulators. Review of compliance for the 2021 year indicates that Brucejack was fully compliant. A small number of hydrocarbon spills were reported as incidents.

6.8.3 Future approvals

A study has been conducted by Newcrest 2022 to examine a range of options to increase production to 4,950 tpd. This study identified the need to amend a number of existing approvals if the study objectives were to be achieved. A phased approach to implementation of changes was proposed transitioning from the approved production rate of 3,800 tpd, to 4,200 tpd (Phase 1) to 4,600 tpd to 4,950 tpd (Phase 2). Approval for both Phase 1 and Phase 2 is targeted for December 2023.

Key environmental impacts that require consideration include:

- Water supply for operations. Additional water will be required and additional water sources may be required. Increased water return from the WRTSF has been identified as a component of additional water requirements. Brucejack will need to demonstrate the ability to maintain required ecological flows to Brucejack Creek during winter.
- Ability to meet required WRTSF water quality discharge standards during operations and post closure as a result of higher daily waste rock and tails discharge volumes. Preliminary modelling indicated potential non-compliance with Al, As, and TSS levels compared to current compliance limits. Other high-risk elements included Cu and nitrates.
- Ability to safely place waste rock and tails within the WRTSF given increase daily production volumes. Need for an additional dump point to be approved has been identified.

The Concept Study identified potential need to amend up to six key permits.

Amendment to the Federal permit is not identified as being required as long as production is maintained below a 5,000 tpd mining threshold trigger. It is noted that changes in application of the Federal legislation presents a risk for the Expansion Project. If an amendment to the Project Decision Statement is required, schedule delays would likely occur as a result of the need to consider transboundary impacts downstream of Brucejack Creek in Alaska.

The proposed expansion does not require changes to lease boundaries and Newcrest considers it unlikely that changes to the EAC (M15-01) will be required as the Expansion Project will not require change to the certified Project Description, approved mining inventory of 18.5 Mt,

Newcrest - Independent Technical Specialist's Report

Grant Samuel & Associates Pty Ltd

0223041

changes to the EAC conditions and there will be no additional significant impacts not previously considered.

Key permits likely to require amendment are Mine Act Permit M-243 and Discharge Permit PE-107835. These can be addressed in a single application. The amendment application will be required to provide an updated mine plan, groundwater model, site water balance, water quality model, deposition plan for the WRTSF and updated Reclamation and Closure Plan and liability costing. The Concept Study identifies the need for change to discharge water quality limits for the WRTSF. A Best Available Technology analysis will be required to be provided to regulators to support a water quality discharge change request. Documentation summarising proposed key changes and impacts was provided to First Nation Stakeholders and regulators for comment in Q3 2022.

6.8.4 SEB offsets

Condition 15 of M15-01 required prior to construction that the proponent enter into a Contribution Agreement with the Province that sets out participation in a programme of activities to support the recovery, conservation and management of the Naas Moose population. Payment amounts of CAD\$7,500 on start of construction and CAD\$3,000 per annum indexed to inflation and reviewable on the number of moose related project vehicle wildlife incidents.

6.8.5 Greenhouse gas emissions and renewable energy targets

The Brucejack Mine reported Scope 1 and 2 emissions of 31,635 and 483 tCO₂^e respectively for the FY22 reporting period. The majority of the Scope 1 emissions arise from use of diesel in haulage and production.

The emissions intensity by tonne of ore milled for FY22 at Brucejack was 23 kg CO₂^e compared to the Newcrest average of 33 kg CO₂^e.

No renewable energy was used for Brucejack in FY22.

6.8.6 Cultural Heritage

Brucejack is located within the traditional territories of four First Nations - Tahltan Nation, Nisga'a Nation, Gitanyow Hereditary Chiefs and Tsetaut Skii km Lax Ha.

Brucejack has entered into Co-operation and Benefits Agreements with the N'isga'a Nation (April 2015), Gitanyow Hereditary Chiefs (June 2016) and Tahltan Nation (October 2017). A Memorandum of Understanding has been entered into with the Tsetaut Skii km Lax Ha (July 2017) which provides the framework for entering into an Impact and Benefit Agreement pursuant to the MOU.

Hunting, trapping, fishing, gathering plant foods and pursuing other traditional activities are central to the economies of Aboriginal groups inhabiting the north-west region surrounding Brucejack. Impacts on these activities is required to be assessed as part of regulatory impact assessment processes.

Ongoing consultation with First Nations people is recognised in various documents reviewed as being an essential part of operations and formal processes are followed where amendments to project design are being sought from regulatory authorities. This includes for:

- M15-01 an approved Aboriginal Consultation Plan and Economic and Social Effect Mitigation Plan (ESEMP). The ESEMP is required to be updated annually during operations.
- M-243 copies of all material reports and plans relevant to the permit including annual monitoring reports and material changes to the approved Reclamation and Closure Plan.

Archaeological studies have been completed as part of baseline studies since 2010 for Brucejack and adjacent areas. One archaeological site was identified within the M-243 permit area. No

Newcrest - Independent Technical Specialist's Report

Grant Samuel & Associates Pty Ltd

0223041

activity has been undertaken within or close to the site. No chance finds have occurred during the life of Brucejack.

A Cultural Heritage Management Plan has been developed and implemented.

Brucejack actively seeks to employ local Indigenous peoples and provides opportunities for education, training, and procurement from local indigenous businesses.

6.8.7 Stakeholder engagement

Brucejack management advises that it regularly engages with indigenous groups, community residents, local, provincial, and Federal government agencies and educational institutions. Evidence of engagement using both formal regulatory mechanisms and proactive mechanisms initiated by the Proponent was observed in documentation reviewed.

The Expansion Project Concept Study in 2022 identified a range of stakeholders required to be engaged with to ensure feedback on the proposal was obtained and incorporated into project design and so that ultimately regulatory approvals could be obtained.

6.8.8 Rehabilitation and closure planning

The Brucejack Permit (M-243) authorises the Mine Plan and Reclamation Program under the Mines Act. The permit has been reviewed a number of times during the life of Brucejack with the most recent authorisation granted in November 2022. The permit authorises disturbance of up to 607.5 ha. Reporting as of March 2022 indicates disturbance of 607.5 ha.

The post mine land use is specified in M-243 as wildlife habitat, particularly matrix habitat for mountain goat, grizzly bear and hoary marmot for the Mine Site and high elevations of the Transmission Line and moose and grizzly bear habitat at lower elevations of the transmission line.

No reclamation work has been undertaken to date. This is consistent with Brucejack's approved plans noting that surface disturbance has been deliberately minimised to limit disturbance of natural land surfaces which have been identified as being potentially acid forming. Opportunities for progressive rehabilitation are very small with the majority of reclamation and closure work scheduled to occur on completion of operations. Reclamation activities are constrained by a natural lack of growth media.

Reclamation research programs have been initiated to investigate uptake of metals in plants and soils, establishment of vegetation. Results are planned to be incorporated into future updates of the Plan.

Brucejack is required to maintain a security with the Province of British Columbia. Newcrest has a total of C\$34M outstanding in rehabilitation bonds for Brucejack as of 30 June 2023. Conditions of M-243 specifically requires the Proponent to covering all closure and reclamation costs notwithstanding the security posted.

Newcrest retained a recognised independent consultant to provide a reclamation liability cost estimate for the portions of the of Brucejack approved under M-243. This cost estimate was submitted to the provincial government per permit condition requirements. The cost estimation methodology was consistent with the requirements of the Provincial Interim Major Mines Reclamation Security Policy (ELMI 2022). The estimate dated 9 December 2022 concluded the estimated LOM cost was CAD\$47.8M inclusive of required contingencies. The largest contributor to the cost was removal of infrastructure at CAD\$18.1M. It was noted that a specific exclusion was costs associated with long term water treatment if required past the 15-month closure treatment period.

Annexure 1. Independent Expert's Report

Newcrest - Independent Technical Specialist's Report

Grant Samuel & Associates Pty Ltd

0223041

A full project closure cost estimate dated 11 November 2022 was prepared by Newcrest noting this addresses closure of all project aspects regardless of land tenure. The cost estimate assumes active closure will occur in a two-year period following completion of mining and ore processing followed by a ten-year post closure phase. A total closure cost of CAD\$84.0 was estimated. This cost is inclusive of human resource costs of CAD\$14.1 M (employee benefits/redundancies), social costs of CAD\$4.0M and contingency allowances of CAD\$8.6M. The majority of the cost is forecast to be realised in FY32 to FY35.

The closure costs appear to be realistic and have been calculated from first principles using recognised methods and inputs. The most significant risk will be requirement for ongoing water treatment post the two-year period allowed for. Annual water treatment costs of CAD\$3.4M have been allowed for during closure. Regulators can realistically be expected to require water treatment to continue until closure criteria can be demonstrated to be met.

6.9 Costs

6.9.1 Operating costs

Historical operating costs for the Brucejack operation are summarised in Table 6.6. Unit costs for mining, processing, and G&A are shown in Table 6.7.

Table 6.6 Brucejack historical operating costs

Operating Costs	Units	FY22 (from April 2022)	FY23
Underground mining	CAD\$M	64.9	171.5
Processing	CAD\$M	11.4	36.6
G&A	CAD\$M	50.8	167.7
Concentrate transport	CAD\$M	8.0	17.5
TCs/RCs and Penalties	CAD\$M	4.1	17.3
Royalty	CAD\$M	3.8	8.9

Newcrest ownership from April 2022.

Table 6.7 Brucejack historical unit operating costs

Activity	Units	FY22	FY23
Mining	CAD\$/t mined	86.2	83.5
Processing	CAD\$/t ore milled	24.6	27.1
G&A	CAD\$/t ore milled	109.6	124.1

Over the short period that Newcrest has operated Brucejack, the operating costs have been aligned with the respective budgets.

6.9.2 Capital expenditure

From the high-level sustaining and non-sustaining capital expenditure available data, Newcrest plans to spend CAD\$6.61M on the Debottlenecking Study. Approximately 65% of the total sustaining capital is for the underground mine, 23% and 12% for infrastructure and the mill respectively over the life of the mine. Non-sustaining capital going forward will comprise a de-bottlenecking project, water treatment plant, infrastructure, and exploration for expansion.

6.10 AMC production cases

6.10.1 AMC Production Case 1

A summary of AMC Production Case 1 is included Table 6.8 and Table 6.9.

AMC Production Case 1 assumes the following plan of operations, assuming only the current ore Reserves are mined until fully depleted.

Newcrest - Independent Technical Specialist's Report

Grant Samuel & Associates Pty Ltd

0223041

- Mined ore quantity was sourced from the Newcrest Ore Reserves as at 30 June 2023 and the production schedule was sourced from the Newcrest LOMP.
- Metal recoveries and concentrate handling charges were sourced from the Newcrest LOMP.
- Mining, milling, and G&A costs were sourced from historical unit costs.
- Capital expenditures were adjusted from the Newcrest LOMP and provided capital expenditure forecast based on the duration of Production Case 1 and no need for mill upgrades that were planned for FY24 through FY26.
- Rehabilitation and exploration costs were taken from the Newcrest LOMP although rescheduled.

Table 6.8 AMC Production Case 1 – Brucejack production schedule

Estimate	Units	FY24	FY25	FY26	FY27	FY28	FY29 to FY38	Total
Total material mined	Mt	1.69	1.69	1.68	1.68	1.68	8.2	16.6
Ore mined	Mt	1.38	1.38	1.38	1.38	1.38	3.65	13.6
Gold grade	g/t	8.41	8.37	8.42	8.35	8.45	8.37	8.39
Ore milled	Mt	1.38	1.38	1.38	1.38	1.38	6.65	13.6
Gold feed grade	g/t	8.41	8.37	8.42	8.35	8.45	8.37	8.39
Gold recovery	%	97.5	97.0	96.9	97.0	97.1	96.9	97.0
Gold Produced	koz	366	362	364	361	366	1,734	3,553

Notes:

- The values in the table are subject to rounding.
- Concentrate produced is in dry metric tonnes.

Table 6.9 AMC Production Case 1 – Brucejack cost schedule

Cost Estimate	Units	FY24	FY25	FY26	FY27	FY28	FY29 to FY38	Total
Operating Costs								
Mining	CAD\$M	152	152	152	152	152	730	1,491
Processing	CAD\$M	39	39	39	39	39	188	383
G&A	CAD\$M	127	127	127	127	127	636	1,271
Capital Expenditure								
Growth capital	CAD\$M	0	0	0	0	0	0	0
Sustaining capital	CAD\$M	57	38	38	33	30	66	262
Rehabilitation	CAD\$M	0	0	0	0	0	103	103

6.10.2 AMC Production Case 2

A summary of AMC Production Case 2 is presented in Table 6.10 and Table 6.11.

AMC Production Case 2 is based on the following plan of operations, assuming only the current Ore Reserves and Inferred Resources are mined until fully depleted.

- Mined ore quantities were sourced from the Newcrest Mineral Resource estimate as at 30 June 2023 and the production schedule was sourced from the Newcrest LOMP.
- Au grade was sourced from the Newcrest LOMP and was de-rated in the last six years of the production plan to reflect uncertainty in the grade of material being mined, which includes Inferred Resources.
- Ag metal grade was sourced from the Newcrest LOMP.
- Metal recoveries and concentrate handling charges were sourced from the Newcrest LOMP.
- Mining, milling and G&A costs were sourced from historical averages.
- Capital expenditures, rehabilitation exploration costs were sourced from the Newcrest LOMP.

Annexure 1. Independent Expert's Report

Newcrest - Independent Technical Specialist's Report

Grant Samuel & Associates Pty Ltd

0223041

Table 6.10 AMC Production Case 2 – Brucejack production schedule

Estimate	Units	FY24	FY25	FY26	FY27	FY28	FY29 to FY38	FY39 to FY48	Total
Total material mined	Mt	1.7	1.9	2.2	2.2	2.2	22.1	2.2	34.5
Ore mined	Mt	1.4	1.6	1.8	1.8	1.8	18.7	1.8	28.3
Gold grade	g/t	8.41	8.37	8.42	8.35	8.45	7.69	7.0	7.85
Ore milled	Mt	1.4	1.6	1.8	1.8	1.8	18.7	1.8	28.3
Gold feed grade	g/t	8.41	8.37	8.42	8.35	8.45	7.69	7.0	7.85
Gold recovery	%	96.9	97.0	96.9	97.0	97.1	96.9	96.8	96.9
Gold Produced	koz	365	418	474	471	477	4,326	393	6,925

Notes:

- The values in the table are subject to rounding.
- Concentrate produced is in dry metric tonnes.

Table 6.11 AMC Production Case 2 – Brucejack cost schedule

Cost estimate	Units	FY24	FY25	FY26	FY27	FY28	FY29 to FY38	FY39 to FY48	Total
Operating Costs									
Mining	CAD\$M	153	176	198	198	199	1,983	198	3,106
Processing	CAD\$M	39	45	51	51	51	510	51	798
G&A	CAD\$M	127	127	127	127	127	1,271	127	2,034
Capital Expenditure									
Growth capital	CAD\$M	94	77	25	-	-	-	-	195
Sustaining capital	CAD\$M	57	38	38	33	30	292	2	490
Rehabilitation	CAD\$M	0	0	0	0	0	0	105	105

6.11 Key risks and opportunities

6.11.1 Risks

In preparing the ITSR, AMC identified the following material risks to Brucejack.

Geology and Mineral Resources

The geology of Brucejack is complex and is associated with extreme grade variability, the risk associated with this is that planned metal and tonnage targets may not be achieved over the short (monthly to quarterly) term.

Geotechnical

There is uncertainty in in situ stress as no stress measurements have been taken. This may affect excavation responses thus impacting ground support and stope performance and dilution particularly mining at depths.

Higher dilution and increased instability could be encountered if poorer rock mass conditions are encountered with current stope dimension guideline.

6.11.2 Opportunities

In preparing the ITSR, AMC identified the following opportunities for Brucejack.

Geology and Mineral Resource

The Brucejack property has significant exploration potential, both near-mine, for example, Golden Marmot and Flow Zone, as well as within the larger exploration licence area.



Newcrest - Independent Technical Specialist's Report

Grant Samuel & Associates Pty Ltd

0223041

Continue with ore sorting trial and testwork

Based on the available information, AMC considers that there is benefit in continuing to pursue ore sorting, as there could be a substantial upside potential for the operation.

Continue with the debottlenecking work

The current site vision is to increase production from 3,800 tpd to 4,950 tpd through the pursuit of mine operational and processing improvements. AMC recommends this work be continued as the mine operational improvements can be expected to add value to Brucejack.

Newcrest - Independent Technical Specialist's Report

Grant Samuel & Associates Pty Ltd

0223041

7 Wafi-Golpu

7.1 Location and background

7.1.1 Location

Wafi-Golpu is located in eastern Papua New Guinea, approximately 65 km south-west of Lae in the Morobe Province of Papua New Guinea as shown in Figure 7.1.

Figure 7.1 Wafi Golpu location

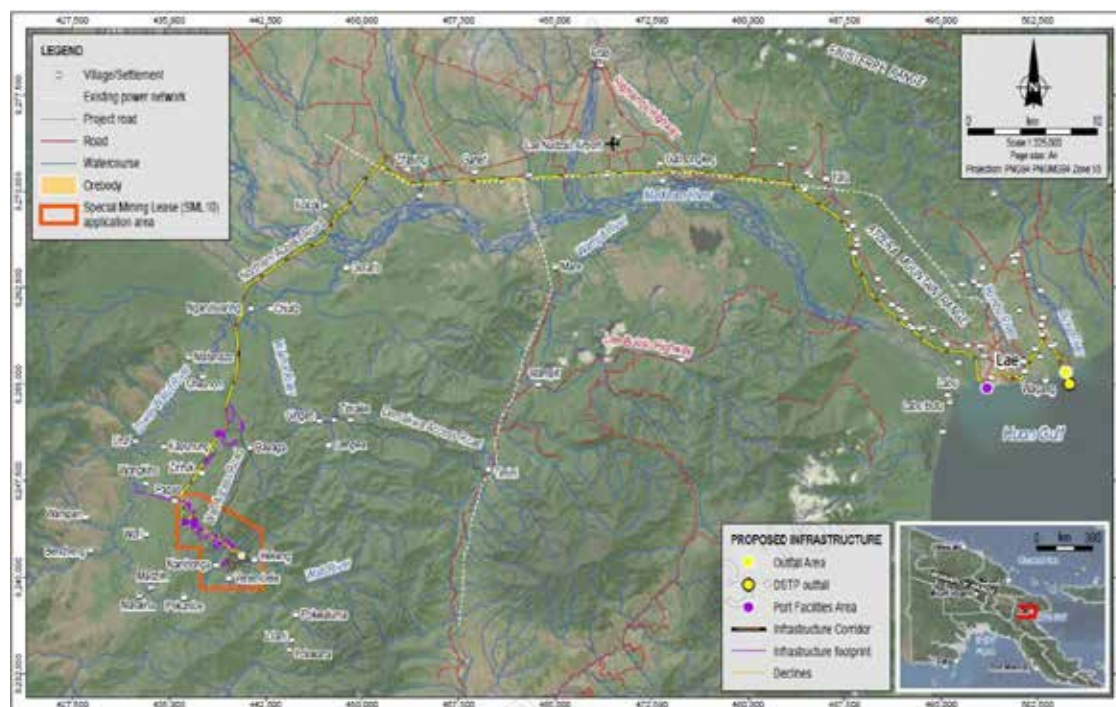

7.1.2 Background

Wafi-Golpu is owned by the Wafi-Golpu Joint Venture (WGJV), one of three unincorporated joint ventures between subsidiaries of Newcrest and Harmony Gold Mining Company Limited (Harmony) referred to collectively as the Morobe Mining Joint Ventures (MMJV).

Gold and copper-gold deposits in the Wafi-Golpu area consist of the Golpu porphyry copper-gold deposit, the Wafi epithermal gold deposit, and the Nambonga porphyry copper-gold deposit. The deposits are situated on the western flanks of the Timini Range. In most areas of the project, the terrain is steep, mountainous, and heavily forested.

Wafi-Golpu has been subjected to a long history of exploration which commenced in 1977. Gold mineralization was initially discovered at the Wafi deposit by CRA Exploration Pty Ltd (CRAE) in 1979. The underlying Golpu porphyry copper-gold deposit was not identified until eleven years later when Elders Resources Limited (Elders) intersected the Golpu porphyry in 1990. The Nambonga deposit was discovered by Harmony in 2008. Since initial discoveries in the project area, several companies completed exploration and resource definition drilling programmes with associated mining studies. WGJV acquired the project in 2009.

There has not been any production from the Wafi-Golpu gold and copper-gold deposits.

Newcrest - Independent Technical Specialist's Report

Grant Samuel & Associates Pty Ltd

0223041

7.1.3 Tenement holdings

The WGJV tenure comprises five ELs. There are also four MLs, seven mining easements, a special mining lease, and three lease for mining purposes under application. The material tenements are EL 1105 and EL 440, covering a total area of approximately 129 km² and registered in the name of the WGJV participants, Newcrest PNG 2 Limited and Wafi Mining Limited, as listed in Table 7.1.

Table 7.1 Wafi-Golpu tenements

Tenement Number	Area (ha)	Tenement Type	Tenement Expiry Date	Status of Currency
EL440	9,501	Exploration Licence	10 March 2024	Live
EL1105	2,800	Exploration Licence	25 January 2023	Renewal pending

7.1.4 Project status

For the Golpu copper-gold deposit, Newcrest reports an Indicated and Inferred Mineral Resource. Ore Reserves are reported by Newcrest for the Golpu deposit based on underground mining using block caving.

For the Wafi gold deposit, Newcrest reports an Indicated and Inferred Mineral Resource, part of the which is refractory. The deposit has potential for open pit mining however no Ore Reserve is reported by Newcrest for Wafi.

For the Nambonga copper-gold deposit, Newcrest reports an Inferred Mineral Resource for the Nambonga copper-gold deposit. The deposit has potential to be mined using a bulk cave underground mining method however no Ore Reserve is reported by Newcrest for Nambonga.

7.2 Site Visit

AMC did not visit Wafi-Golpu as part of preparing this ITSR.

7.3 Geology and Mineral Resources

7.3.1 Golpu deposit

Mineral Resources for Golpu were reported as at 30 June 2023 from a model developed by WGJV in 2015. The 2015 model is a variation of a model completed by WGJV in June 2014 that was an update of previous estimates following further drilling and reassessment of geological controls on mineralization. The underlying resource model used for reporting of the 30 June 2023 Mineral Resource estimate, including geological fields, estimated grades and density and Mineral Resource classification, remains the same as the June 2014 resource model.

The 30 June 2023 reporting of the Mineral Resource estimate was modified from June 2014 reporting by reporting the estimate as the entire contents of a constraining shell using a value model and cost structure developed in the Golpu 2015 LOMP. The constraining shell applies a breakeven NSR of US\$22.29 based on a value model using pre-feasibility study level metal prices, metallurgical recoveries and costs for mining and processing. The constraining shell is not a block cave design but represents the potentially extractable Mineral Resource using a bulk underground cave mining method.

The Golpu Mineral Resources estimate reported as at 30 June 2023 is listed in Table 7.2. reported as the total of the estimate. Newcrest's attributable share is 50%. Mineral Resources are reported inclusive of Ore Reserves.

Newcrest - Independent Technical Specialist's Report

Grant Samuel & Associates Pty Ltd

0223041

Figure 7.2 Golpu Mineral Resources as at 30 June 2023

Classification	Tonnes Mt (Dry)	Grade			Contained Metal		
		Au (g/t)	Cu (%)	Ag (g/t)	Au (Moz)	Cu (Mt)	Ag (Moz)
Indicated	690	0.71	1.1	1.3	16	7.5	28
Inferred	140	0.63	0.85	1.1	2.8	1.2	4.6

Notes:

- All data reported is on a 100% asset basis.
- In March 2021, the then Governor of the Morobe Province commenced a judicial review application against the State of PNG, challenging the December 2020 grant of the environment permit for the Wafi-Golpu Project. In December 2022 a number of villagers from the Huon Gulf coastal area commenced a separate judicial review application against the State of PNG also challenging the grant of the project's Environment Permit. Both reviews are still to be heard and determined. Newcrest attributable share 50%.

AMC confirmed reporting of the Mineral Resource estimate within the constraining shell.

7.3.1.1 Geology

Regionally, Golpu lies in a block of deformed upper Mesozoic to Middle Miocene metasedimentary and sedimentary rocks cut by Miocene and Pliocene calc-alkaline diorite intrusives (Figure 7.3). Copper and gold mineralisation results from a porphyry system with its upper portion overprinted by high-sulfidation epithermal alteration. The porphyry system consists of multiple hornblende-bearing diorite porphyries intruding host sedimentary rocks.

Figure 7.3 Wafi-Golpu geology

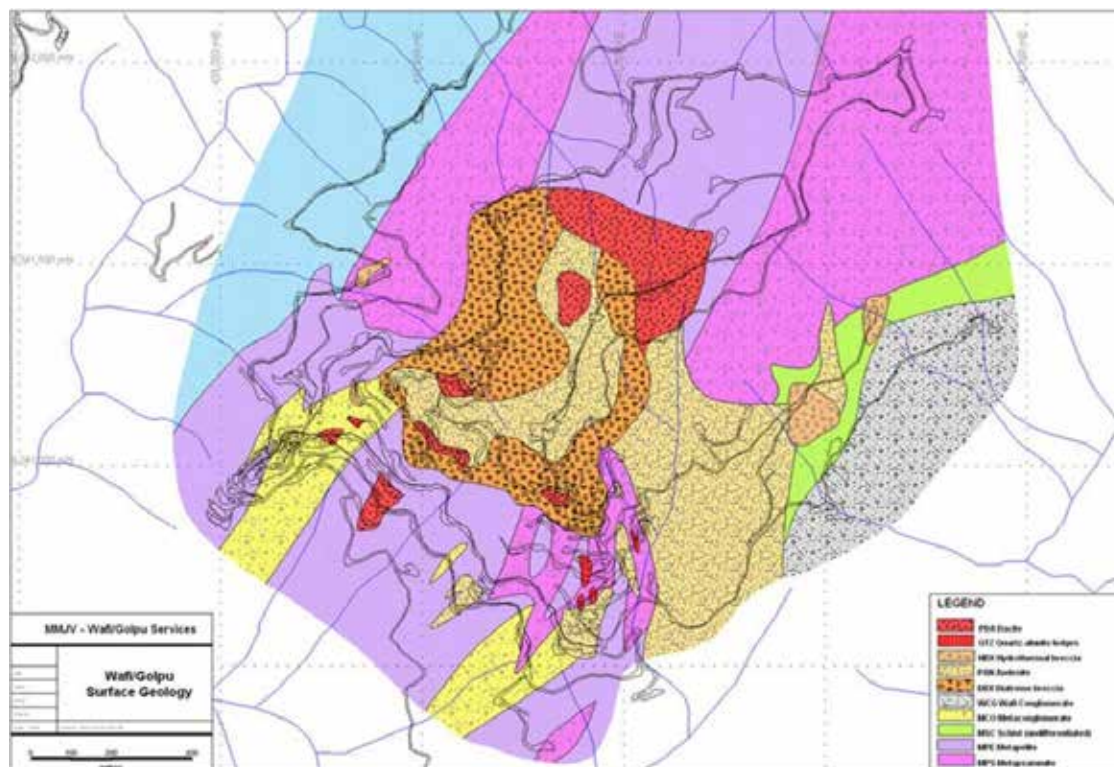

The Golpu intrusive complex consists of multiple hornblende-bearing diorite porphyries intruded into sedimentary rocks. The porphyries can be distinguished based on their spatial position and into coarse-grained hornblende-rich variants, feldspathic-rich units and porphyries containing quartz eye inclusions. Cross-cutting intrusive contacts and inliers of earlier intrusives are rare.

Newcrest - Independent Technical Specialist's Report

Grant Samuel & Associates Pty Ltd

0223041

Three main porphyry phases are identified: Golpu Porphyry, Hornblende (Liviana) Porphyry (including the Western Porphyry), and Diorite Porphyry (Figure 7.4). The Golpu Porphyry comprises dominantly sparsely porphyritic feldspar diorite. The Hornblende Porphyry is distinctly porphyritic with large tabular hornblende phenocrysts set in a finer-grained groundmass. The Diorite Porphyry is the only quartz-eye porphyry interpreted as a large intrusive body.

Figure 7.4 Porphyries in the Golpu intrusive complex

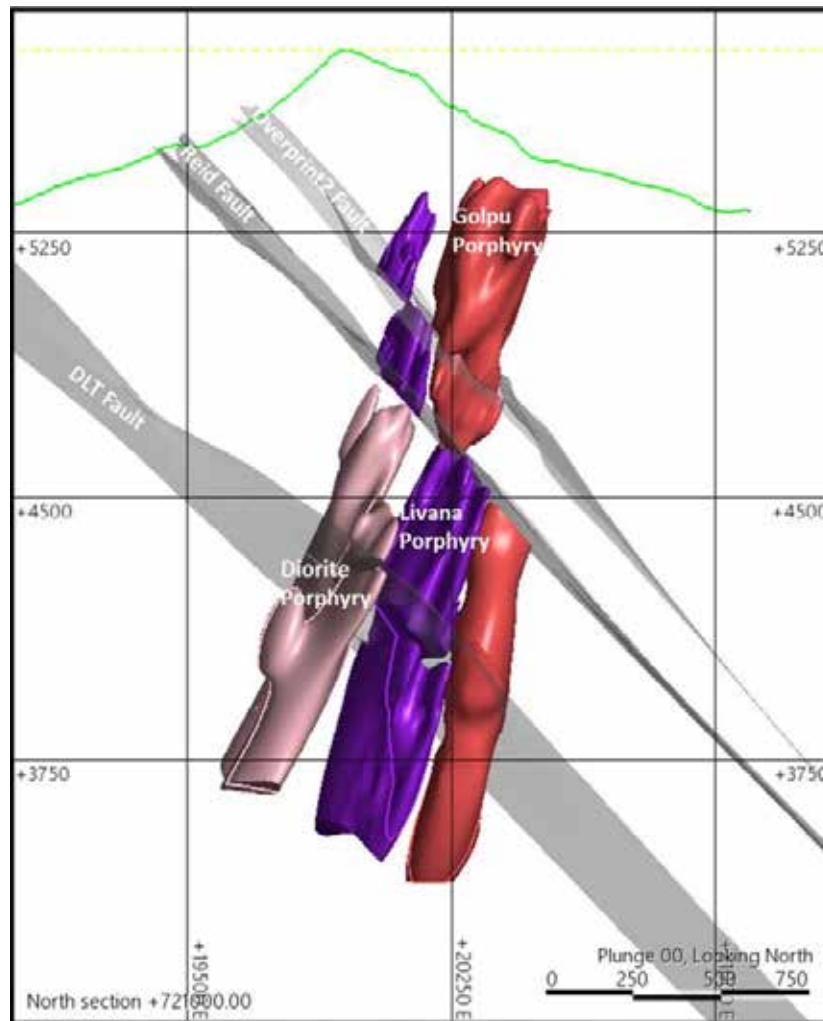

The Golpu deposit is approximately 800 m by 400 m in area and elliptical in plan and extends from 200 m below surface to greater than 2,000 m. Hydrothermal alteration related to the porphyry copper-gold mineralization forms a zonal arrangement from a potassic core to propylitic margins. The presence of actinolite is a key indicator of the limits to copper-gold mineralization. High-sulfidation epithermal alteration overprints the upper portion of the porphyry system forming a central alunite-quartz (advanced argillic) core grading out to dickite-kaolinite (argillic) with an outer margin of sericite alteration. Mineralization is derived from either the porphyry or epithermal systems.

In the porphyry system gold, copper, silver, and molybdenum mineralization is disseminated, micro fracture and stockwork vein controlled. Copper, gold and silver grade from a high-grade

Newcrest - Independent Technical Specialist's Report

Grant Samuel & Associates Pty Ltd

0223041

core to low grades in sedimentary rocks on the mineralized margin. Molybdenum occurs as an annulus outside the higher-grade copper-gold porphyry.

The dominant copper and gold-bearing sulphide minerals varies laterally and vertically from an inner bornite (plus chalcopyrite) core to chalcopyrite as the dominant copper sulphide and grading out to a pyrite-only shell on the margin (Figure 7.5).

Figure 7.5 Golpu copper sulphide zonation

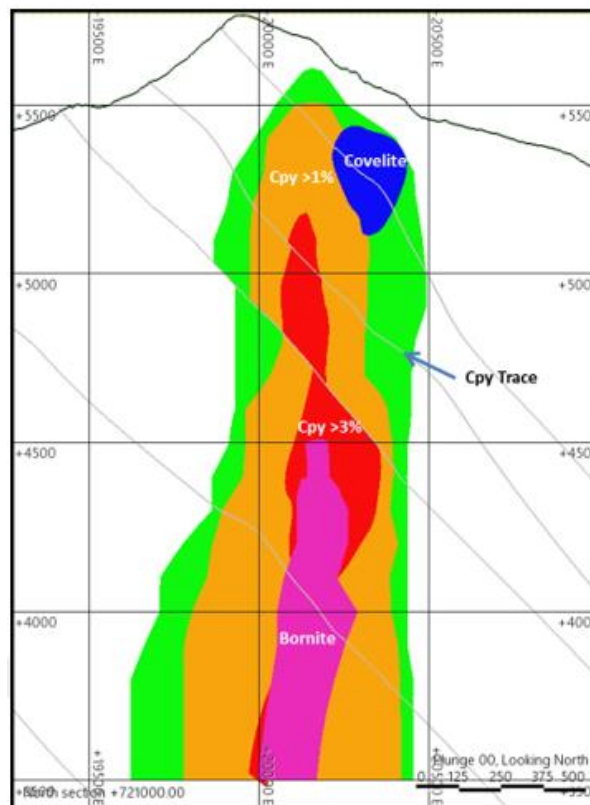

The Hornblende Porphyry is the main mineralised porphyry with other porphyries either as weak sources of mineralisation or as benign hosts to mineralization initiated by other porphyries.

In the overprinting epithermal system gold occurs with pyrite or as electrum associated with pyrite, enargite and tetrahedrite. Epithermal mineralization follows the metasedimentary and volcanic host rock stratigraphy. Arsenic and sulphur are elevated in the high sulfidation epithermal system.

Post-mineral reverse faulting has dismembered the original porphyry and epithermal system with offsets of up to 200 m and rotated the high-grade porphyry between faults to dip 70° to the west. Four faults (DLT Fault, Reid Fault, Overprint Fault, Overprint2 Fault) intersect the Golpu porphyries and are interpreted to influence alteration and grade distribution.

7.3.1.2 Data collection

Drilling

Diamond drillholes are the principal source of geological and grade information for Golpu. The data used for the 2014 Mineral Resource estimate included 120 drillholes totalling 54,732 m (refer Table 7.2) of drilling that fall within the Mineral Resource volume. Other drilling, mainly

Newcrest - Independent Technical Specialist's Report

Grant Samuel & Associates Pty Ltd

0223041

targeted at the overlying Wafi epithermal mineralization, does not contribute to the Golpu Mineral Resource estimate.

Table 7.2 Summary of Golpu drilling within the reported resource volume

Company	Number of Holes	Metres Drilled (m)	Start Date	Finish Date
Elders	5	1,408	1990	1991
CRAE	25	9,530	1991	1996
Harmony	10	4,797	2005	2008
WGJV	80	38,997	2009	2014
Total	120	54,732		

Figure 7.6 shows the layout of drilling for the Golpu Mineral Resource estimate in relation to WGJV drilling in the Wafi and Nambonga areas.

Figure 7.6 Golpu - drillhole traces

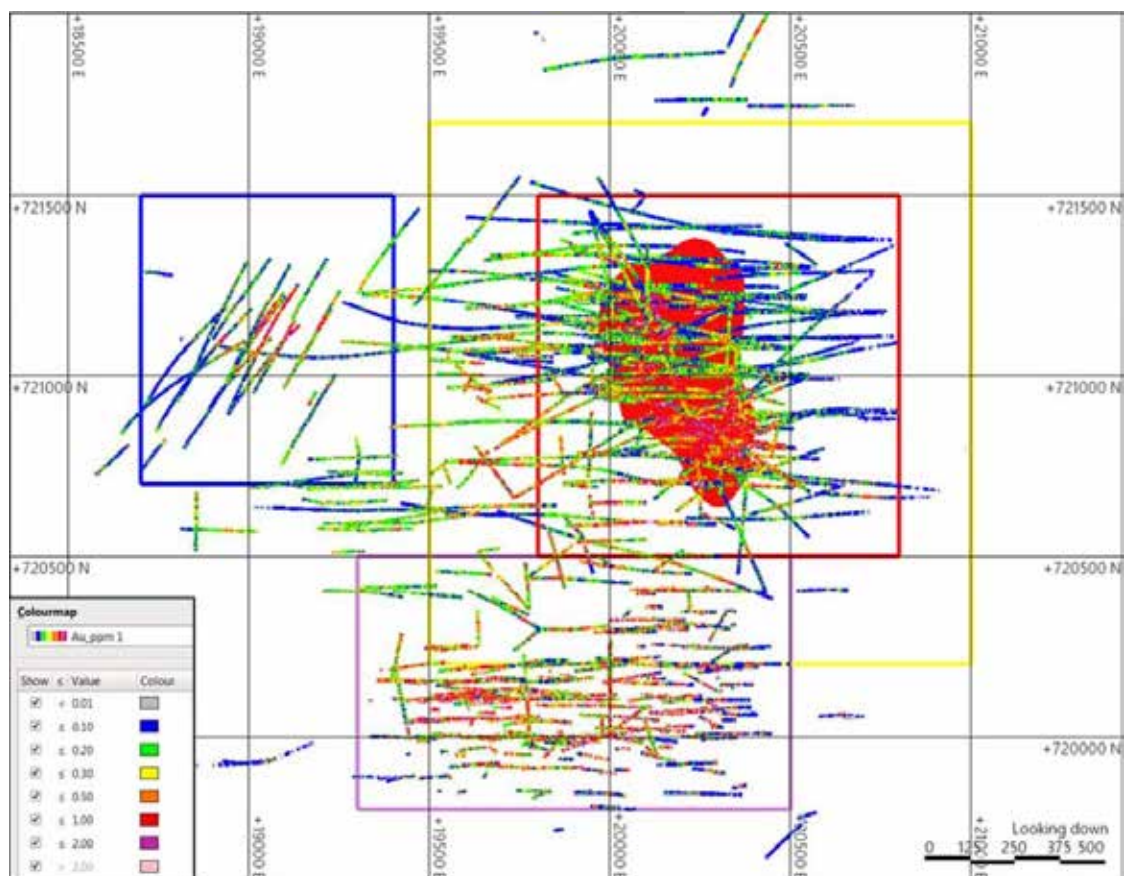

Diamond drilling used wireline methods using PQ, HQ, and NQ diameter core. Drillhole spacing is irregular because of the different orientation of drillholes. Drilling density varies from less than 50 m spacing above 5100 mRL to 150 m by 150 m below 4,200 mRL. Much of the Indicated Mineral Resource has been drilled at approximately 75 m spacing increasing to about 100 m at its deepest part. Recent drilling has used triple tube core barrels and a core orientation system.

Newcrest - Independent Technical Specialist's Report

Grant Samuel & Associates Pty Ltd

0223041

All diamond drillhole collar locations have been surveyed in the Wafi Local Grid (WLG) by either theodolite or differential GPS. The WLG is rotated from true north by approximately 45 degrees. The main height datum is Mean Sea Level (MSL). Because much of the Mineral Resource is significantly below MSL, 5,000 m was added to MSL for the WLG to avoid negative values.

Topographic control is derived from a high-resolution Lidar survey conducted in 2007.

Downhole surveys were completed on CRAE diamond drillholes mainly using an Eastman single shot camera typically at 25 m and then at every 20 m to 50 m downhole. More recently drillholes have been surveyed using a Reflex downhole survey tool at 30 m intervals and at 10 m intervals in some deep wedged holes where directional control was important.

All drillholes have been geologically and geotechnically logged for lithology, alteration, mineralization, mineralogy, weathering and structure. Drill core has been photographed.

Core recovery is 98.4% within the Golpu Mineral Resource volume. There is no apparent relationship between recovery and grade.

Sampling and analysis

Diamond drillholes were sampled over their entire length in 1 m or 2 m intervals. Most samples are half core with quarter-core samples used for larger diameter PQ drill core.

Sample preparation protocols have varied over time. Sampling from CRAE and Elders drilling during 1990 to 1996 was prepared at Pilbara (Analabs) Laboratories in Lae. Samples were dried and jaw crushed to a nominal 5 mm then entirely pulverised to 180 microns. A sub-sample of 500 g was obtained with a riffle splitter which was pulverised to nominal 75 microns. A 100 g sub sample (pulp) was obtained and despatched for analysis.

Sample preparation for Harmony and WGJV drillholes during 2005 to 2011 was carried out at Intertek Laboratory in Lae sample pulps sent to Intertek Laboratory in Jakarta for analysis. All samples were dried at 60°C then jaw crushed to nominal 2 mm. A sub sample of 1.5 kg was obtained with a riffle splitter which was pulverised to 75 microns. A 250 g sample pulp was taken for analysis.

Sample preparation for WGJV drillholes 2012 to 2014 was carried out at Intertek Laboratory in Lae. Samples were dried at 60°C, then crushed in a Boyd Crusher to <2.8 mm with a minimum 95% passing 2.8 mm. A sub-sample of 3.5 kg was obtained using a rotary splitter and then pulverised with a minimum 95% passing 106 microns. A 250 g sample pulp was taken for analysis at obtained and despatched for analysis Intertek Laboratory in Jakarta.

Repeat samples are obtained from pulverised material at the rate of 1 in 20 samples. For a later period of drilling, 1 in 20 repeat coarse duplicate samples were also submitted.

Assay quality control

Drilling carried out prior to the Harmony drilling campaign had variable quality control protocols. No quality control appears to have been in place for the original CRAE drilling. Some duplicate data are available for Elders drilling and the second CRAE campaign.

Drilling campaigns by Harmony and WGJV were supported by quality control procedures that included:

- CRMs.
- Pulp duplicates at the primary laboratory.
- Pulp duplicates at an umpire laboratory.
- Coarse duplicates.
- Blank samples.

Newcrest - Independent Technical Specialist's Report

Grant Samuel & Associates Pty Ltd

0223041

WGJV collated and re-examined all assay quality control data for all drilling at Golpu. The conclusions of the quality control review are:

- Most of the CRAE first campaign and Elders and Abelle drilling for which some assay uncertainty exists were targeted at the Wafi epithermal deposit and do not influence the Golpu Mineral Resource estimate.
- About 13% of the data used for the Golpu Mineral Resource estimate come from the second CRAE campaign, where duplicates show some scatter but no systematic bias.
- Results for blank samples for Harmony and WGJV drilling show acceptable results with some outliers probably caused by mislabelled samples.
- CRM assays for gold show no significant bias for all grade ranges over time.
- Primary and umpire pulp duplicate assays for gold returned acceptable results both within the primary laboratory and between laboratories.
- CRM assays for copper show a negative bias in grades less than 10,000 ppm Cu and no bias in higher grades. This is attributed to a sample digestion issue.
- Umpire pulp duplicates for Harmony and WGJV drilling indicated lower grades than the primary laboratory.
- Subsequent umpire pulp duplicates submitted to another umpire laboratory with CRMs suggest that the umpire laboratory for 2008 to 2010 drilling returned low-biased copper assays. Subsequent umpire pulp duplicates indicate that the primary laboratory returns low-biased copper assays in the grade range less than 10,000 ppm Cu.
- Coarse duplicates (a duplicate of the coarse crushed sample) prepared in 2013 submitted to the primary laboratory returned acceptable results.

Overall, most of the drilling used for the June 2014 Mineral Resource estimate was supported by an acceptable quality control protocol that supports primary gold assays and suggests that lower-grade primary copper assays are 5% to 7% biased low. The low bias introduces an element of grade conservatism in the estimated copper grade.

Density Determination

The determination of bulk density was undertaken on solid pieces of core, 10 cm in length generally at 10 m intervals down hole. The main method of density determination was the measurement of the mass of an uncoated sample in air and submerged in water (the Archimedes method). Approximately 5% of density samples were wax coated to prevent water incursion and the Archimedes method applied.

Bulk density domains were interpreted from oxidation, alteration and lithology. Statistical analysis was performed on each domain and anomalous values were excluded from the dataset. Mean density by density domain was assigned to the block model.

7.3.1.3 Mineral Resource estimation

Volume model

The geological model for the Mineral Resource estimate includes lithology, alteration, oxidation, sulphide distribution and structure wireframes. In the June 2014 estimate, coded drillholes and parameters that reflect geological continuity have been used to develop wireframes. The overall limit to estimated grade is a shell based on the first appearance of actinolite which has been correlated with the limit of copper and gold mineralization.

Four faults intersect the Golpu porphyries and are interpreted to influence alteration and grade distribution. The Reid Fault is treated as a hard boundary for copper and gold grade estimation because of different grade characteristics above and below the fault. The Overprint2 and DLT Faults have been used to distinguish estimation domains. The Overprint Fault does not influence copper grade estimation but is used in gold grade estimation to distinguish epithermal gold mineralisation associated with argillic and advanced argillic alteration.

Annexure 1. Independent Expert's Report

Newcrest - Independent Technical Specialist's Report

Grant Samuel & Associates Pty Ltd

0223041

Copper estimation domains are outlined in Figure 7.7.

Figure 7.7 Copper estimation domains

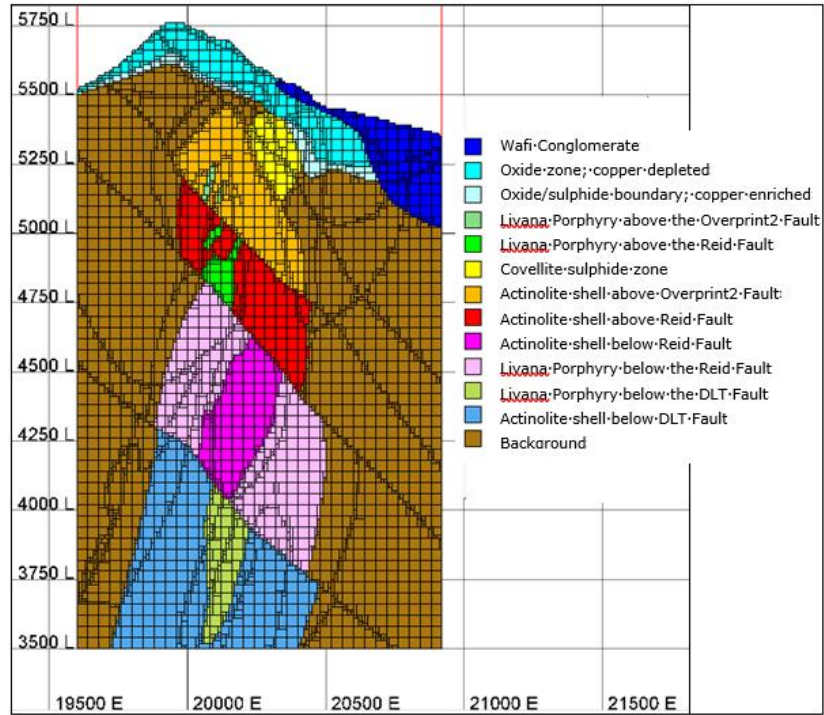

Source: modified from Newcrest

Gold estimation domains are outlined in Figure 7.8.

Newcrest - Independent Technical Specialist's Report

Grant Samuel & Associates Pty Ltd

0223041

Figure 7.8 Gold estimation domains

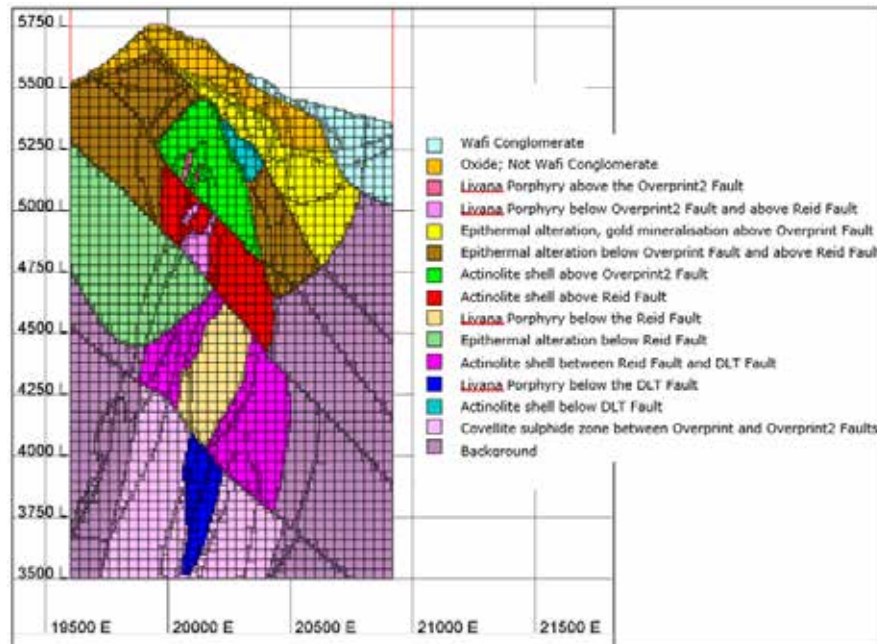

Source: modified from Newcrest

The application of hard or soft boundaries across estimation domains was evaluated using boundary analysis.

The details of the volume model are listed in Table 7.3. The parent cell size (40 m by 40 m by 40 m) is appropriate for the drillhole spacing and the proposed mining method. The level of cell splitting adequately delineates boundaries. Grade estimation is into parent cells which is appropriate.

The volume model is coded for the porphyry, alteration and oxidation domains although these are not all used to control grade estimation. The volume model is also coded for the copper and gold estimation domains.

Table 7.3 Volume model parameters.

Parameter	Minimum	Maximum	Model Extent (m)
Easting	19600	20920	1,320
Northing	720300	721620	1,320
RL	3500	5980	2,480
X Dimension	10	40	-
Y Dimension	10	40	-
Z Dimension	10	40	-

Compositing and grade capping

Assays were composited to 10 m for variography and grade estimation. Composites were split at estimation domain boundaries.

Composite statistics were examined by review of histograms and percentage of metal contributed from the highest-grade composites in each estimation domain. Grade caps were

Newcrest - Independent Technical Specialist's Report

Grant Samuel & Associates Pty Ltd

0223041

applied in some gold and copper estimation domains. In some other domains, outlier values were considered to form a valid subset of the population. In these domains, a restricted search was applied to the higher grades (described as a high-yield estimation) and the broader search ellipse used data with a grade cap applied. This restricts the influence of the high-grade composites. AMC considers that the application of grade caps and high-yield estimation is appropriate for constraining the influence of outlier values.

Variography and grade estimation

Grades were estimated into a block model using OK, honouring the estimation domains and using parameters derived from a study of variography.

Variograms were modelled for all domains for all estimated variables. Pairwise, relative variograms were used to model grade continuity. Some domains contain a limited number of composites and variogram models were used from the closest matching domain. Most well-informed domains generate well structured, low nugget variograms in both pairwise and raw models.

All porphyry-related domains were modelled with an orientation defined by the elongation of the porphyry system with the major direction 345°, 70° dip to the west and 10° northern plunge. Argillic alteration, oxidation and cover sequence domains have shallow dips to grid east that were used in the variogram models.

Search ellipses used in grade estimation were anisotropic with the radii for most domains the same as the ranges of the second structure of modelled variograms. The minimum number of composites allowed for successful estimation varied between 8 and 12 depending on the estimation domain and the maximum number of composites varied between 16 and 24. A maximum of between 6 and 8 composites were allowed from an individual drillhole.

Bulk density domains were interpreted from oxidation, alteration and lithology. Statistical analysis was performed on each domain and anomalous values were excluded from the dataset. Mean density by density domain was assigned to the block model.

The Mineral Resource estimate was validated by comparing with estimates using NN and ID² methods. Swath plots were prepared comparing the grade in slices of the resource model to the NN estimate by northing, easting and level. Model grades were compared with declustered composite grades. The validation demonstrates that the Mineral Resource provides a reasonable reflection of the distribution of copper and gold grades reflected in the drillhole data.

Resource classification and reporting

The Mineral Resource was classified based on data spacing and distribution, geological confidence in continuity and complexity of geological features, and estimation quality parameters. The estimate is classified as Indicated Mineral Resource, where the geological framework can be modelled with confidence and mineralisation continuity can be demonstrated. It extends from below the copper enrichment zone to the DLT Fault, approximately 1,400 m below surface (Figure 7.9). Below this fault and above 3780 mRL, drillhole spacing increases and geological and grade continuity is less reliable. This part of the estimate is classified as Inferred Mineral Resource.

Newcrest - Independent Technical Specialist's Report

Grant Samuel & Associates Pty Ltd

0223041

Figure 7.9 Mineral Resource classification.

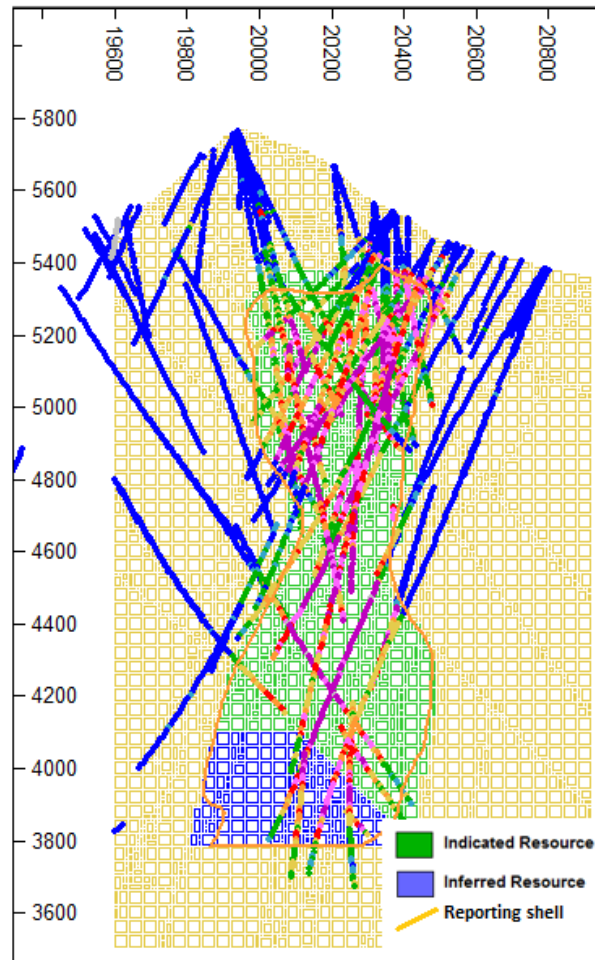

Source: AMC from Newcrest-supplied data

The 30 June 2023 reporting of the Mineral Resource estimate was based on the June 2014 modified by reporting the estimate as the entire contents of a constraining shell using a value model and cost structure developed in the Golpu 2015 LOMP. The constraining shell applies a breakeven NSR of US\$22.29 based on a value model.

The constraining shell is not a block cave design but represents the potentially extractable Mineral Resource using a bulk underground cave mining method.

The metal prices and costs used to derive Mineral Resource reporting parameters were established in 2015. Updated metal prices and costs may result in a different Mineral Resource being reported from the same underlying resource model.

AMC comments on the Mineral Resource estimate

Drillhole data acquired by WGJV demonstrates acceptable data quality, but there is some uncertainty about earlier data because older protocols do not meet current standards. A substantial amount of drilling since 2009, supported by quality control protocols, places less reliance on the historical data in the estimation of the Mineral Resource.

Newcrest - Independent Technical Specialist's Report

Grant Samuel & Associates Pty Ltd

0223041

AMC considers that the geological and alteration model provides a suitable framework to estimate the geological control on grades.

The parent cell size of the volume model (40 m by 40 m by 40 m) is appropriate for the drillhole spacing. The level of cell splitting adequately delineates boundaries. Grade estimation is into parent cells which is appropriate.

Estimation domains were based on contact boundary analyses, statistical evaluation and assessment of the impact on grade distribution in the geology and alteration domains. The evaluation of estimation domains through statistical and boundary analysis is thorough and AMC considers that the conclusions drawn are reasonable.

Grade estimation used conventional OK with parameters determined from a study of variography. Compositing, grade caps and the application of the high-yield estimation method to control the influence of local high grades in composites are appropriate.

Model validation shows that gold and copper grades in the model are supported by the data.

Density was assigned to the block model based on mean values distinguished by oxidation, lithology, and alteration domains.

AMC considers that the Mineral Resource classification is appropriate. AMC confirmed reporting of the Mineral Resource estimate within the constraining shell.

The metal prices and costs used to derive Mineral Resource reporting parameters were established in 2015. Updated metal prices and costs may result in a different Mineral Resource being reported from the same underlying resource model.

AMC considers that the June 2014 Mineral Resource estimate for Golpu used for Mineral Resource reporting as at 30 June 2023 has been completed using accepted industry practices. AMC considers that the estimate is appropriately classified as Indicated and Inferred Mineral Resources and that the Mineral Resources reported from this model are acceptable for public reporting in accordance with the JORC Code.

7.3.2 Wafi deposit

The Wafi gold deposit is located on tenements held by the WGJV.

Mineral Resources reported for Wafi as at 30 June 2023 are based on a Mineral Resource estimate completed by WGJV in 2019. There has been no mining at Wafi. No Ore Reserves are reported for the Wafi deposit.

Table 7.4 lists the Wafi Mineral Resource in 100% terms. Newcrest's attributable share is 50%. The Wafi Mineral Resource estimate has been reported within a notional spatial constraining shell developed using a gold price of US\$1,400 per ounce. The non-refractory mineralization in the Mineral Resource estimate is reported at 0.4 g/t Au cut-off grade and the refractory mineralization in the Mineral Resource estimate is reported at 0.9 g/t Au cut-off grade.

Newcrest - Independent Technical Specialist's Report

Grant Samuel & Associates Pty Ltd

0223041

Table 7.4 Wafi Mineral Resource as at 30 June 2023.

Classification	Tonnes Mt (Dry)	Grade		Contained Metal	
		Au (g/t)	Ag (g/t)	Au (Moz)	Ag (Moz)
Indicated	110	1.7	4.4	5.7	15
Inferred	37	1.4	4.2	1.6	5.0

Notes:

- All data reported on a 100% asset basis.
- In March 2021, the then Governor of the Morobe Province commenced a judicial review application against the State of PNG, challenging the December 2020 grant of the environment permit for the Wafi-Golpu Project. In December 2022 a number of villagers from the Huon Gulf coastal area commenced a separate judicial review application against the State of PNG also challenging the grant of the project's Environment Permit. Both reviews are still to be heard and determined. Newcrest attributable share 50%.

AMC confirmed reporting of the Mineral Resource estimate within the constraining shell.

7.3.2.1 Geology

Gold mineralization at Wafi and copper-gold porphyry style mineralization at Golpu are associated with a dacite porphyry diatreme and associated breccia and altered metasediments. Gold mineralization at Wafi is centred on a complex intrusive-related system hosted in metasediments of the Owen Stanley Metamorphics. The metamorphics comprise an interbedded sequence of sedimentary and volcanic units with the dominant units being conglomerate, sandstone and mudstone. The metamorphics are metamorphosed to greenschist facies and are weakly to moderately foliated.

The Wafi deposit lies within north-west to north and north-east trending regional structures about 60 km north-north-west of the Wau Graben. The major north-northwest trending faults bounding the Wau Graben extend into the Wafi area and have likely influenced the formation and distribution of gold mineralization.

Intrusive phases include diorite porphyry stocks including the mineralized Golpu Porphyry. The younger intrusive Heking Andesite appears to be a shallow sill-like body between Wafi and the Golpu Porphyry. The diatreme breccia contains a number of unmineralized dacite porphyries.

The diatreme breccia at the centre of Wafi is a north-south elongated body comprising a mixture of sedimentary and intrusive breccias, volcanoclastic units and tuffs. It has been intruded by several phases of unmineralized dacitic porphyries.

The younger units of the Babwaf Conglomerate and the Wafi Conglomerate overlying the older units.

The main structural features of Wafi include the Rafferties and Dokaton Fault systems. These are north-west striking, steeply-dipping structures that pass through the north-east of the Wafi area on either side of the Golpu porphyry.

The weathering profile in the Wafi area shows considerable variation with fresh primary sulphide mineralization occurring in outcrop and also completely oxidized material to depths of 150 m. Generally the weathering profile is deeper on the eastern side of Mount Golpu and above the Golpu Porphyry. On the western side of Mount Golpu the weathering profile is typically very shallow and less than 10 m in depth.

Newcrest - Independent Technical Specialist's Report

Grant Samuel & Associates Pty Ltd

0223041

The Wafi gold deposit is hosted in the metasedimentary units of the Owen Stanley Metamorphics and peripheral to the diatreme breccia complex. Mineralization occurs as disseminated sulphides and quartz vein stockworks in advanced argillic to intermediate argillic altered siltstone and sandstone units. Gold mineralization is sheet-like and moderately north-east plunging. Gold mineralization accompanied a zoned high and low-sulphidation epithermal event with alteration zonation from earliest to latest:

- Argillic alteration: alunite ± pyrophyllite overgrowing quartz.
- Intermediate argillic alteration: dickite + kaolinite ± sericite/illite.
- Low-temperature argillic alteration: carbonate + smectite + chlorite + chalcedony.

The alteration zonation is also reflected by the sulphide mineralogy with enargite and luzonite zoning to tennantite to base-metal sulphide zones.

Mineralization is thought to be sub-parallel to bedding and is preferentially hosted in coarser-grained units such as metaconglomerate and metapsammite. Other contributing factors associated with mineralization are thought to be the distance from the diatreme and its associated gradient from low pH and higher temperatures to near neutral pH and low temperatures with distance.

Much of the gold mineralization is considered to be refractory with the gold associated with arsenical pyrite. Historic metallurgical testwork for this mineralization returned poor results for cyanidation. Mineralization located above the base of oxidation is largely non-refractory.

The resource model is based on the interpretation of mineralization domains, modified by location with respect to faults. In the 2019 resource model, arsenic grades were used to define some mineralization domains and for others a nominal gold grade threshold was applied. The mineralization domains consist of:

- Link Zones: A series of discrete zones of mineralization defined using implicit modelling of a shell using a 300 ppm As threshold modified to include gold grades >1 g/t Au outside the arsenic shell.
- Western Zone: Implicit modelling of a shell using a 300 ppm As threshold modified to include gold grades >1 g/t Au outside the arsenic shell.
- Bridge Zones: Discrete zones of gold mineralization based on implicit modelling of gold grades >1 g/t Au.
- Gold Cap: Discrete zone of gold mineralization based on implicit modelling of gold grades >1 g/t Au in oxide and transition zones only.
- Northern Zone: a small discrete zones of gold mineralization defined at a >1 g/t Au threshold.

The mineralization zones are further modified by their location above or below the Overprint Fault, the Reid Fault and the Bridge Fault. The 300 ppm arsenic shell correlates with the argillic alteration domain and contains most gold grades >1 g/t Au.

The resource model identifies oxide, transition, and fresh rock oxidation domains that are used for assigning densities but are not used to distinguish grade estimation domains. Background grades have been estimated in the surrounding sedimentary host rocks.

7.3.2.2 Data collection

Drilling

A total of 791 drillholes have been completed in the Wafi-Golpu area since 1983 for a total of 334,130 m drilled. Within the volume of the Wafi 2019 Mineral Resource estimate, 301 DD holes for 131,198 m drilled and 85 RC drillholes for 14,557 m drilled have been relied on for estimation.

Newcrest - Independent Technical Specialist's Report

Grant Samuel & Associates Pty Ltd

0223041

Diamond drilling used wireline methods using PQ, HQ, and NQ diameter core. Drillhole spacing is irregular but is typically 50 m to 100 m (Figure 7.10) extending to 200 m at depth. Drilling is clustered around the high-grade Link Zone and the higher-grade parts of A Zone. Recent drilling has used triple tube core barrels and a core orientation system.

Figure 7.10 Plan of Wafi drillhole traces.

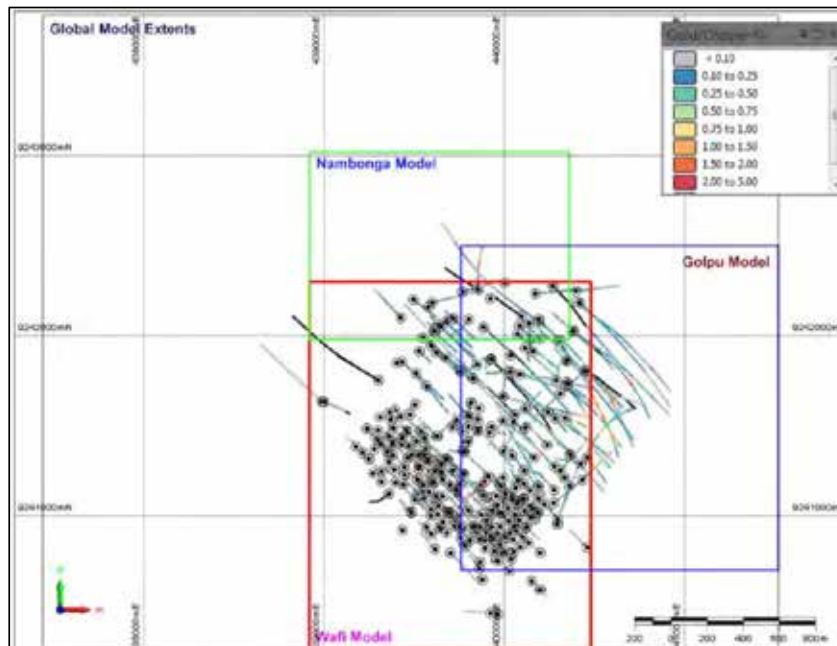

All diamond drillhole collar locations have been surveyed in the WLG by either theodolite or differential GPS. The WLG is rotated from true north by approximately 45 degrees. The main height datum is mean sea level modified by adding 5,000 m to avoid negative values.

Topographic control is derived from a high-resolution Lidar survey conducted in 2009.

Downhole surveys were completed on CRAE diamond drillholes mainly using an Eastman single shot camera typically at 25 m and then at every 20 m to 50 m downhole. More recently drillholes have been surveyed using a Reflex downhole survey tool at 30 m intervals.

All drillholes have been geologically and geotechnically logged for lithology, alteration, mineralization, mineralogy, weathering and structure. Drill core has been photographed.

Core recovery is greater than 90% within the Wafi mineralization domains. There is no apparent relationship between recovery and grade.

Sampling and analysis

Diamond drillholes were sampled over their entire length in 1 m or 2 m intervals. Most samples are half core with quarter core samples used for larger diameter PQ drill core. RC drillhole sampling is not described in Mineral Resource documentation.

Sampling, sample preparation, analytical procedures and assay quality control that relate to Wafi-Golpu have been described in the section of this ITSR describing the Golpu Mineral Resource estimate.

Newcrest - Independent Technical Specialist's Report

Grant Samuel & Associates Pty Ltd

0223041

Density Determination

The determination of bulk density was undertaken on solid pieces of core, 10 cm in length generally at 10 m intervals down hole. The main method of density determination was the measurement of the mass of an uncoated sample in air and submerged in water (the Archimedes method). Approximately 5% of density samples were wax coated to prevent water incursion and the Archimedes method applied.

Bulk density domains were interpreted from oxidation and lithology identified in the resource model by the field "rockcode". Statistical analysis was performed on each rockcode and anomalous values were excluded. Mean density by rockcode was assigned to the blocks in the resource model.

7.3.2.3 Mineral Resource estimation

Volume model

The resource model is based on the interpretation of mineralization domains, modified by location with respect to faults. Coded drillholes and parameters that reflect geological continuity have been used to develop wireframes. The resource model identifies oxide, transition, and fresh rock oxidation domains that are used for assigning densities but are not used to distinguish grade estimation domains.

The details of the volume model are listed in Table 7.5. The parent cell size (20 m by 20 m by 20 m) is appropriate for the drillhole spacing. The level of cell splitting adequately delineates boundaries. Grade estimation is into parent cells which is appropriate.

Table 7.5 Volume model parameters.

Parameter	Minimum	Maximum	Model Extent (m)
Easting	438920	440780	1,860
Northing	9240260	9718420	2,040
RL	4700	5780	1,080
X Dimension	10	20	-
Y Dimension	10	20	-
Z Dimension	5	10	-

Compositing and grade capping

Samples have been mostly taken at 2 m intervals. Assays have been composited to 4 m lengths for grade estimation.

Grade caps for all estimated variables were assessed by estimation domain. In general, grades were capped at the 99th percentile of composite grades which generally resulted in a modest decrease in mean composite grades. Gold grade caps in mineralization domains varied from 3.5 g/t Au to 22 g/t Au.

Variography and grade estimation

Grade estimation used OK with estimation parameters based on calculation and modelling of variograms. The approach used applied a gaussian transform to composites for variogram modelling and back transformation into real space. Variograms were modelled for all domains for all estimated variables. Variograms were interpreted with common axis directions that reflect the orientation of mineralization domains.

Search ellipses used in grade estimation were anisotropic. A three-pass strategy was applied with the search ellipses expanding and the number of composites allowed for successful estimation decreasing in each pass. The search ellipse in the first pass was 160 m by 120 m by

Newcrest - Independent Technical Specialist's Report

Grant Samuel & Associates Pty Ltd

0223041

30 m, doubling in the second pass. Twenty-four composites were allowed for estimation in the first pass, with between 12 and 24 composites allowed in the second pass. A maximum of 8 composites per hole was allowed in the first and second pass.

The Mineral Resource estimate was validated by visually comparing the estimated grades with composite grades. The estimate was compared with an estimate ID² estimation. Swath plots were prepared comparing the grade in slices of the resource model with declustered composite grades. The validation demonstrates that the Mineral Resource provides a reasonable reflection of the distribution gold grades reflected in the drillhole data.

Resource classification and reporting

The Mineral Resource was classified based on data spacing and distribution, geological confidence in continuity and complexity of geological features, and estimation quality parameters. The estimate is classified as Indicated Mineral Resource, where the geological framework can be modelled with confidence and mineralisation continuity can be demonstrated. Outside that, but within the notional constraining shell, the Mineral Resource estimate is classified as Inferred Resource.

The Mineral Resource is reported in a notional constraining shell developed assuming open pit mining and using a gold price of US\$1,400 per ounce. The shell used costs and recoveries related to a 2013 study using a mining cost of US\$5.40 per tonne, processing cost of US\$15.17/t, and gold recovery of 91% in non-refractory mineralization and 46% in refractory mineralization. The non-refractory mineralization in the Mineral Resource estimate is reported at 0.4 g/t Au cut-off grade and the refractory mineralization in the Mineral Resource estimate is reported at 0.9 g/t Au cut-off grade.

The metal prices and costs used to derive Mineral Resource reporting parameters were established in 2013. Updated metal prices and costs may result in a different Mineral Resource being reported from the same underlying resource model.

AMC comments on the Mineral Resource estimate

AMC considers that drilling, sampling and assay procedures, while they have varied to a minor degree over time, have been conducted using accepted industry practices.

Much of the gold mineralization is considered to be refractory with the gold associated with and locked within arsenical pyrite. The geological model provides a suitable framework to estimate the geological control on grades.

The parent cell size of the volume model (20 m by 20 m by 5 m) is appropriate for the drillhole spacing. The level of cell splitting adequately delineates boundaries. Grade estimation is into parent cells which is appropriate.

The estimation across domain boundaries used hard and soft boundaries in different cases determined by boundary analysis.

Grade estimation used conventional OK with parameters determined from a study of variography. Compositing and grade caps are appropriate.

The metal prices and costs used to derive Mineral Resource reporting parameters were established in 2013. Updated metal prices and costs may result in a different Mineral Resource being reported from the same underlying resource model.

AMC considers that the Wafi Mineral Resource estimate is suitable for Mineral Resource reporting in accordance with the JORC Code.

Model validation shows that gold grades in the model are supported by the data.

Newcrest - Independent Technical Specialist's Report

Grant Samuel & Associates Pty Ltd

0223041

AMC considers that the Mineral Resource classification is appropriate. AMC confirmed reporting of the Mineral Resource estimate within the constraining shell.

7.3.3 Nambonga deposit

The Nambonga copper/gold deposit is located on tenements held by the WGJV one of three unincorporated joint ventures between subsidiaries of Newcrest and Harmony referred to collectively as the MMJV. The WGJV holds two exploration licences (EL 1105 and EL 440) covering a total area of approximately 129 km² registered in the name of the WGJV participants.

Gold mineralization was initially discovered at Wafi by CRAE in 1983. The underlying Golpu porphyry copper-gold deposit was not identified until eleven years later when Elders intersected the Golpu porphyry in 1990. The Nambonga deposit was discovered by Harmony in 2008. Since that time several companies have completed exploration and resource definition drilling programmes with associated mining studies. WGJV acquired the project in 2009.

Mineral Resources reported for Nambonga as at 30 June 2023 are based on a Mineral Resource estimate completed by WGJV in 2018. There has been no mining at Nambonga. No Ore Reserves are reported for Nambonga.

Table 7.6 lists the Nambonga Mineral Resource in 100% terms. Newcrest's attributable share is 50%. The Nambonga Mineral Resource estimate has been reported as the entire model contents of a notional spatial constraining shell assuming mining by non-selective block cave underground mining methods. The shell was developed at a 0.5 g/t Au grade threshold.

Table 7.6 Nambonga Mineral Resources as at 30 June 2023.

Classification	Tonnes Mt (Dry)	Grade		Contained Metal	
		Au (g/t)	Cu (%)	Au (Moz)	Cu (Mt)
Inferred	48	0.69	0.20	1.1	0.094

Notes:

- All data reported on a 100% asset basis.
- In March 2021, the then Governor of the Morobe Province commenced a judicial review application against the State of PNG, challenging the December 2020 grant of the environment permit for the Wafi-Golpu Project. In December 2022 a number of villagers from the Huon Gulf coastal area commenced a separate judicial review application against the State of PNG also challenging the grant of the project's Environment Permit. Both reviews are still to be heard and determined. Newcrest attributable share 50%.

AMC confirmed reporting of the Mineral Resource estimate within the constraining shell.

7.3.3.1 Geology

Gold mineralization at Wafi and copper-gold porphyry style mineralization at Golpu and Nambonga are associated with a dacite porphyry diatreme and associated breccia and altered metasediments. The Nambonga deposit lies in a block of deformed upper Cretaceous meta-sedimentary to sedimentary rocks cut by Miocene-Pliocene calc-alkaline dioritic intrusives. Copper and gold mineralisation results from a multiple intrusive porphyry system with the upper portion overprinted by high-sulfidation epithermal alteration.

Figure 7.11 shows the spatial relationship between Golpu, Wafi, and Nambonga deposits.

Newcrest - Independent Technical Specialist's Report

Grant Samuel & Associates Pty Ltd

0223041

Figure 7.11 Location of Golpu, Wafi, and Nambonga deposits.

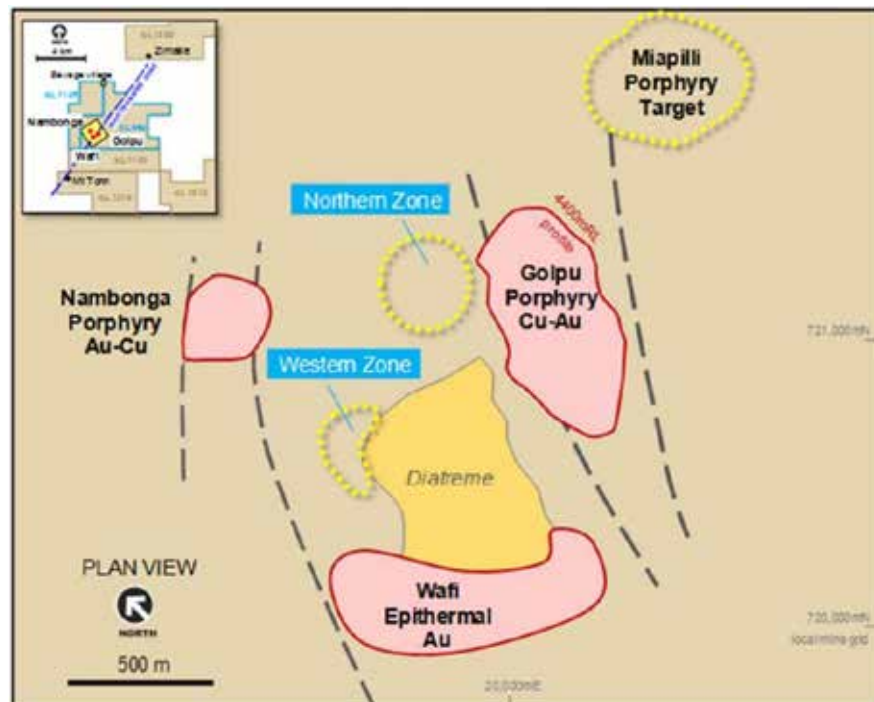

The Nambonga porphyry stock is a single body that indicates some fractionation. The porphyry is a medium-grained porphyry of plagioclase and hornblende phenocrysts cells in a feldspathic matrix.

The porphyry stock displays classical porphyry alteration zonation. Strong silicification, brecciation, and quartz stockwork veining is pronounced in the upper levels within the carapace of the porphyry and meta sedimentary contact. Phyllic alteration characterised by sericite-K feldspar-chlorite-pyrite is associated with the brecciation in the upper level particularly in the hangingwall of the porphyry. Phyllic alteration overprints the early potassic event and is likely to have remobilized the primary copper and enhanced the overall copper and gold grades.

Potassic alteration occurs commonly as selvages to veins and as pervasive zones with increased vein density. The potassic alteration partly overprints and grades into a peripheral propylitic zone that is characterised by a chlorite-carbonate-epidote-pyrite assemblage.

Mineralisation at Nambonga is diverse with precious and base metal occurrences as both disseminated vein style. Much of the mineralization is associated with silicification either pervasive or as veins. Quartz stockwork veins overprint the porphyry especially in the upper levels. Chalcocopyrite is the primary copper sulphide in the porphyry system. Gold is likely to be intergrown in a lattice with chalcocopyrite or pyrite. In addition to gold-copper mineralization, zones of structurally-controlled base metal mineralisation form steeply-dipping lodes of variable thickness usually at the margins of the diorite porphyry.

Newcrest - Independent Technical Specialist's Report

Grant Samuel & Associates Pty Ltd

0223041

7.3.3.2 Data collection

Drilling

The WGJV tenements have been subjected to a long history of exploration which commenced in 1977. Gold was initially discovered at the Wafi deposited by CRAE in 1979. The Golpu porphyry copper-gold deposit was not identified until 11 years later. The Nambonga deposit was not discovered until 2008 at which time the deposit was drilled out.

A total of 34 diamond drillholes have been drilled at Nambonga for 19,877 m of drilling. Some geotechnical drilling related to the development of the Golpu deposit has been carried out in 2018.

Diamond drilling was completed using PQ, HQ and NQ diameter drill core. Most of the samples collected in the porphyry were in HQ and NQ core diameters. Drillhole spacing at the collars is approximately 100 m along 80 m-spaced sections (Figure 7.12). Drillhole spacing in the mineralization is typically greater than 60 m and can be up to 100 m in some parts of the deposit. Diamond drilling used triple tube core barrels. Sampling was half core or quarter core in PQ diameter core. Sample intervals are dominantly one metre with some two-metre samples.

Figure 7.12 Nambonga drillhole traces.

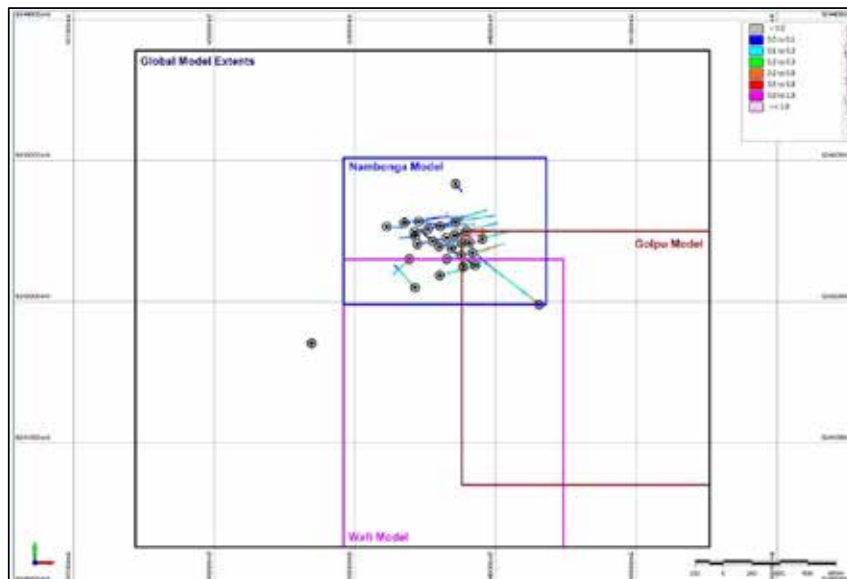

All diamond drillhole collar locations have been surveyed in the WLG by either theodolite or differential GPS. The WLG is rotated from true north by approximately 45 degrees. Because much of the Mineral Resource is significantly below MSL, 5,000m was added to MSL for the WLG to avoid negative values.

Downhole surveys were completed typically at 25 m and then every 50 m downhole. Downhole surveys were conducted using Eastman single shot cameras and recently using a Reflex downhole survey tool.

Topographic control is derived from a high-resolution Lidar survey conducted in 2007.

All drillholes have been geologically and geotechnically logged for lithology, alteration, mineralization, mineralogy, weathering and structure. Drill core has been photographed.

Newcrest - Independent Technical Specialist's Report

Grant Samuel & Associates Pty Ltd

0223041

Average core recovery is greater than 95% in the Nambonga drilling with recoveries of 100% in most of the drilling. There is no apparent relationship between recovery and grade.

Sampling and analysis

Diamond drillholes were sampled over their entire length mainly in 1 m intervals. Most samples are half core with quarter core samples used for larger-diameter PQ drill core.

Sampling, sample preparation, analytical and assay quality control that relate to Wafi-Golpu have been described in the section of this ITSR describing the Golpu Mineral Resource estimate.

Drilling by WGJV including the Nambonga drilling was analysed by Intertek Laboratory in Jakarta and included submission of CRMs, blanks, quarter core duplicates and re-assay of selected pulp splits at a second laboratory. Gold was assayed by 50 g fire assay with AAS finish. Multielement analysis including copper were determined by two-acid digestion ICP-MS finish. Where copper grade exceeded 10,000 ppm Cu, copper was determined using four-acid digestion with ICP-MS finish. No significant bias was apparent in gold CRMs. A consistent low bias of between 5% and 7% in copper grades in samples using two-acid digestion.

Blanks returned acceptable results. Pulps sent to a second laboratory showed good correlation for gold. Copper results show that original assays had a negative 7.5% bias compared to the umpire laboratory.

Density Determination

The determination of bulk density was undertaken on solid pieces of core, 10 cm in length generally at 10 m intervals down hole. The main method of density determination was the measurement of the mass of an uncoated sample in air and submerged in water (the Archimedes method). Approximately 5% of density samples were wax coated to prevent water incursion and the Archimedes method applied.

Bulk density domains were interpreted from oxidation and lithology and identified in the resource model by the field "domain". Statistical analysis was performed on each domain and anomalous values were excluded. Mean density by domain was assigned to the block model.

7.3.3.3 Mineral Resource estimate

Volume model

The resource model is based on the interpretation of lithology, alteration, oxidation, and structural wireframes. Wireframes were constructed using implicit modelling from primary logging codes. Two porphyries were modelled: the Nambonga Porphyry, the main mineralized diorite porphyry and the Late Porphyry, an intermediate porphyry that cuts across the main mineralized porphyry stock. Other lithologies include dacite, diatreme, Wafi Conglomerate, Babwaf Conglomerate, Owen Stanley Metamorphics, and Recent cover. Oxidation surfaces were modelled at the base of complete oxidation and the top of fresh rock.

Fault wireframes include the major thrust faults which are interpreted to displace mineralisation. The most significant thrust fault is the Buvu Fault which defines the floor to the Nambonga system. The Upper Buvu Fault is interpreted to cut through the Nambonga Porphyry system. The Nambonga Fault is a breccia zone that contains significant mineralization.

Contact analysis was conducted to determine grade variations across geological boundaries.

Annexure 1. Independent Expert's Report

Newcrest - Independent Technical Specialist's Report

Grant Samuel & Associates Pty Ltd

0223041

Domain codes were assigned to the model for estimation (Figure 7.13):

- 2122 Late Porphyry.
- 2123 Nambonga Porphyry.
- 2124 Nambonga Porphyry below Upper Buvu Thrust.
- 2125 Stockwork.
- 2016 Metasediments.

Figure 7.13 Nambonga estimation domains.

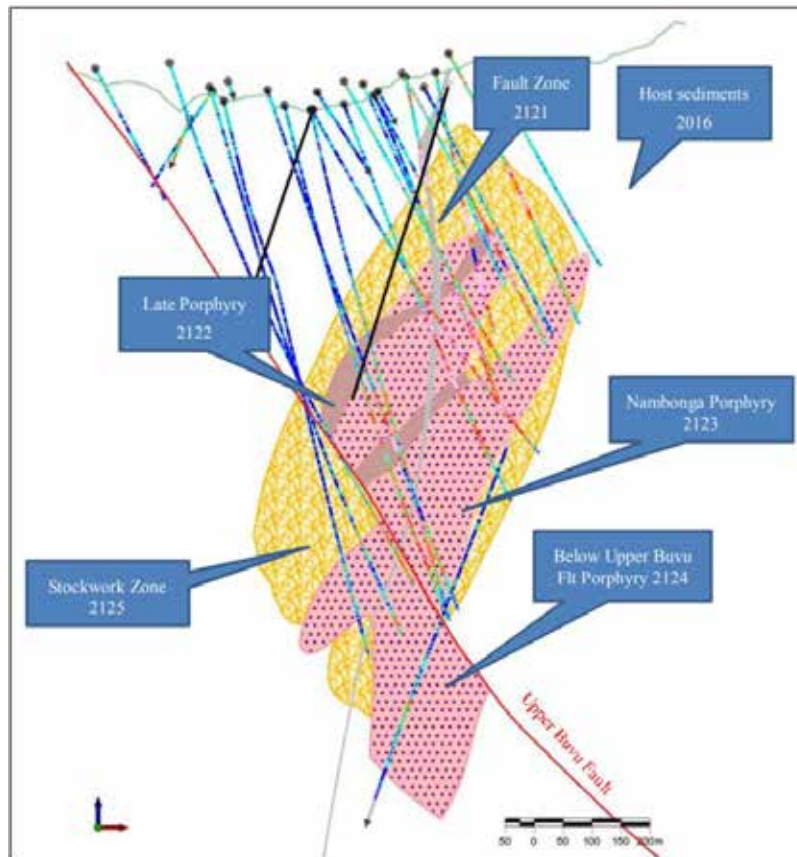

The details of the volume model are listed in Table 7.7. The parent cell size (40 m by 40 m by 40 m) is appropriate for the drillhole spacing and the proposed mining method. The level of cell splitting adequately delineates boundaries. Grade estimation is into parent cells which is appropriate. The volume model is coded for the oxidation and estimation domains.

Table 7.7 Volume model parameters.

Parameter	Minimum	Maximum	Model Extent (m)
Easting	438920	440360	1,440
Northing	9241980	9243020	1,040
RL	4000	5800	1,800
X Dimension	10	40	-
Y Dimension	10	40	-
Z Dimension	10	40	-

Newcrest - Independent Technical Specialist's Report

Grant Samuel & Associates Pty Ltd

0223041

Compositing and grade capping

Samples have been mostly taken at 1 m intervals. Assays have been composited to 2 m lengths for grade estimation.

Grade caps were determined by a review of statistical parameters, graphed data, decomposition analysis, and the percentage of metal contributed by the highest-grade composites. Grade caps 0.7% Cu and 2.0 g/t Au were applied across all estimation domains.

Variography and grade estimation

Grade estimation used conventional OK with estimation parameters based on calculation and modelling of variograms. The approach used applied a gaussian transform to composites for variogram modelling and back transformation into real space. Variograms were modelled for all estimated variables and data combined for the main estimation domains (Nambonga Porphyry and stockwork domains). Variogram models from the combined domains were used for estimation in all other domains.

Search ellipses used in grade estimation were anisotropic and oriented in the dominant trend of the porphyry. A two-pass strategy was applied with the search ellipse radii doubling in the second pass. The search ellipse in the first pass was 320 m by 166 m by 190 m, doubling in the second pass. A minimum of 16 and a maximum of 28 composites were allowed for estimation. A maximum of 8 composites per hole was allowed.

Density data (1,009 determinations) were assessed regarding oxidation, alteration and lithology. For the Mineral Resource estimate, mean densities within each domain were assigned to the model:

- Late Porphyry 2.68 t/m³.
- Nambonga Porphyry 2.72 t/m³.
- Nambonga Porphyry below Upper Buvu Thrust 2.74 t/m³.
- Stockwork 2.88 t/m³.
- metasediments 2.85 t/m³.

The Mineral Resource estimate was validated by visually comparing the estimated grades with composite grades. The estimate was compared with an estimate using ID² estimation. Swath plots were prepared comparing the grade in slices of the resource model to declustered composite grades. The validation demonstrates that the Mineral Resource provides a reasonable reflection of the distribution gold grades reflected in the drillhole data.

Resource classification and reporting

The Mineral Resource was classified based on data spacing and distribution, geological confidence in continuity and complexity of geological features, and estimation quality parameters. The estimate is classified as Inferred Mineral Resource.

The Mineral Resource is reported as the entire model contents of a constraining shell developed at a 0.5 g/t Au grade threshold assuming mining using a bulk underground cave mining method. The Mineral Resource includes the tonnes and grade of model cells within the shell that are less than 0.5 g/t Au and excludes outlier model cells greater than 0.5 g/t Au. The constraining shell is not a block cave design but represents the potentially extractable Mineral Resource.

AMC comments on the Mineral Resource estimate

AMC considers that drilling, sampling and assay procedures, while they have varied to a degree over time, have been conducted using accepted industry practices.

Newcrest - Independent Technical Specialist's Report

Grant Samuel & Associates Pty Ltd

0223041

The parent cell size of the volume model (40 m by 40 m by 40 m) is appropriate for the drillhole spacing and the proposed mining method. The level of cell splitting adequately delineates boundaries. Grade estimation is into parent cells which is appropriate.

The estimation across domain boundaries used hard and soft boundaries in different cases determined by boundary analysis.

Grade estimation used conventional OK with parameters determined from a study of variography. Compositing and grade caps are appropriate.

Model validation shows that gold and copper grades in the model are supported by the data.

Reporting of the Mineral Resource within a notional constraining shell assuming mining using bulk cave mining method is appropriate.

AMC considers that the Mineral Resource classification is appropriate. AMC confirmed reporting of the Mineral Resource estimate within the constraining shell.

AMC considers that the Nambonga Mineral Resource estimate is suitable for Mineral Resource reporting in accordance with the JORC Code.

7.4 Mining operations and Ore Reserves

7.4.1 Current mining operations

There are no current mining operations at Wafi-Golpu.

7.4.2 Ore Reserves and estimation process

Ore Reserves have been estimated for the Golpu deposit based on a feasibility study completed in March 2018. The feasibility study proposed a three-lift block cave mine plan with extraction levels on the 4,400 mRL (BC44), 4,200 mRL (BC42) and the 4,000 mRL (BC40). The Golpu Ore Reserve design is shown in Figure 7.14 with a section through the Golpu Ore Reserve block model displaying NSR ranges. The mine will be accessed by the Watut declines (conveyor and service declines) and Nambonga decline (for early establishment of ventilation infrastructure and drilling platforms).

Newcrest - Independent Technical Specialist's Report

Grant Samuel & Associates Pty Ltd

0223041

Figure 7.14 Golpu Ore Reserve design – view looking north

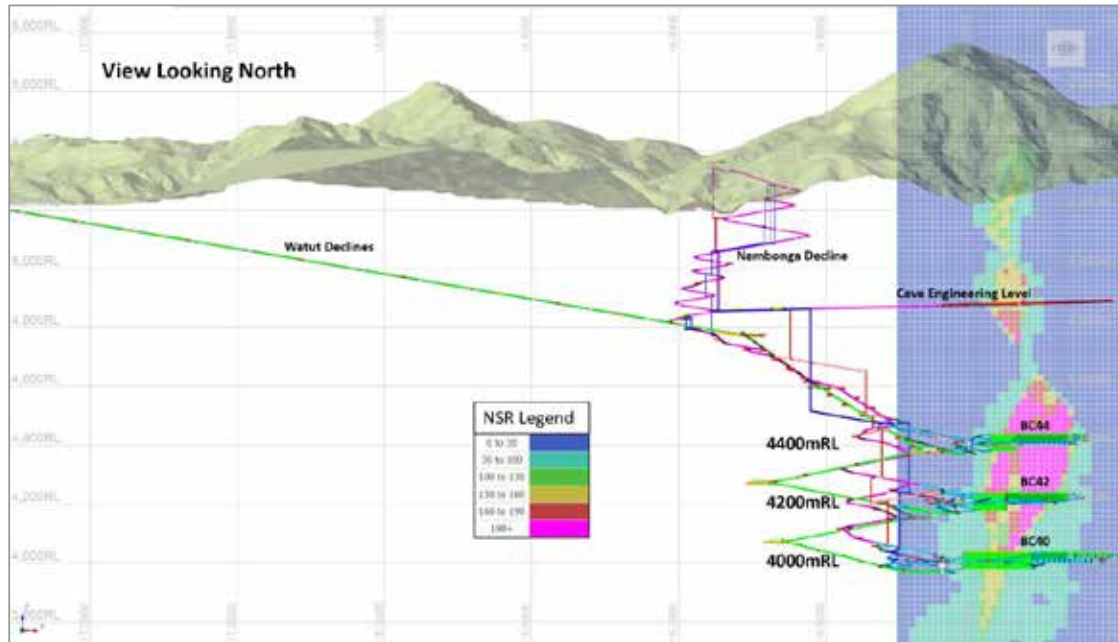

The Ore Reserves estimate utilised Panel Cave Block Cave software for cave production scheduling and estimation of grade. Shut-off NSR values applied for the estimation of the Ore Reserve at Golpu were:

- US\$10/t milled – for development prior to first BC44 crusher commissioning.
- US\$60/t milled – BC44.
- US\$40/t milled – BC42.
- US\$19.15/t milled – BC40.

The Golpu Ore Reserves estimate as at 30 June 2023 is shown in Table 7.8. The Golpu Ore Reserve estimate has remained the same since the completion of the feasibility study in 2018. Total life-of-mine dilution is approximately 17% made up of 79 Mt of either Inferred Mineral Resource or unclassified material. The dilution included in the Ore Reserve is 7% of the gold metal and 5% of the copper metal.

Table 7.8 Golpu Ore Reserves as at 30 June 2023

Classification	Tonnes Mt (Dry)	Grade		Contained Metal	
		Au (g/t)	Cu (%)	Au (Moz)	Cu (Mt)
Probable	400	0.86	1.2	11	4.9

Notes:

- All data reported on a 100% asset basis.
- In March 2021, the then Governor of the Morobe Province commenced a judicial review application against the State of PNG, challenging the December 2020 grant of the environment permit for the Wafi-Golpu Project. In December 2022 a number of villagers from the Huon Gulf coastal area commenced a separate judicial review application against the State of PNG also challenging the grant of the project's Environment Permit. Both reviews are still to be heard and determined. Newcrest attributable share 50%.
- Golpu Ore Reserve is based on the 2018 FS Update which used a gold price of US\$1200/Oz and USD:PGK Foreign exchange of 3.13.

Newcrest - Independent Technical Specialist's Report

Grant Samuel & Associates Pty Ltd

0223041

AMC observes that the Ore Reserves estimate has been built from a cost and revenue basis that is now approaching six years old. There have been significant changes to each of those areas over that period.

7.4.3 Resource development and future mining concepts

Since the Feasibility Study Update, a conceptual mine plan has been developed as an option to reduce the number of block cave lifts from three to two. Extraction levels for this plan are located on the 4,300 mRL and the 4,000 mRL. Upper mine development layouts (Watut and Nambonga declines) remain unchanged from the Feasibility Study Update. Lower mine development between the 4,800 mRL and the 4,000 mRL has been modified to better suit the reduced number of extraction levels. The revised mine design is shown in Figure 7.14 Golpu Ore Reserve design – view looking north Figure 7.14 with a section through the Golpu Ore Reserve block model displaying NSR ranges.

The design has similar aspects to Cadia with an El Teniente extraction level layout and an inclined conveyor haulage system. The Nambonga decline is developed concurrently with the Watut twin (access and conveyor) declines to provide earlier access to drilling platforms and to establish primary ventilation.

Design capacity of 17 Mtpa is achieved 10 years after the commencement of mine development. Lateral development is completed in two campaigns with a distinct drop off between establishment of the two caves BC43 and BC40. There is a production dip as mining of the BC43 cave ceases and the BC40 cave ramps up.

The feasibility study mine plan for Golpu has been independently reviewed by consultants considered to be experts in caving. Key challenges for the project include:

- Lateral development rates – difficulty in achieving planned development rates due to poor ground conditions and likely high groundwater inflows.
- Production – maintaining sustainable cave management/draw control strategy to avoid individual caves running away.
- Stress management – modelling indicates that cave induced stress will be an issue on all proposed levels and will need intensive schedule control to manage stress build ups during construction and production ramp-up.

Actions in the mine plan to address some of those challenges include:

- Scheduled development rates varied by geotechnical domain.
- Development of a revised mine plan which has two block cave lifts as opposed to three in the Feasibility Study update.
- Vertical de-stress slots on cave production levels to mitigate stress impacts on key infrastructure.

7.5 Mineral processing

7.5.1 Processing plant description

The plant is a copper flotation concentrator that will initially process 8.4 Mtpa, expanding to 16.8 Mtpa after 9 years. It is comprised of a SAG mill with pebble crusher, a ball mill in closed circuit with cyclones, copper rougher flotation, copper rougher cleaner for the copper concentrate of the first rougher cell, copper concentrate regrind to increase liberation of the minerals from the second and subsequent rougher cells, three stage copper cleaning and cleaner scavenger flotation.

The copper rougher concentrate (from the first rougher) and the third copper cleaner concentrate are combined and feed a concentrate thickener. Thickened concentrate is pumped to the port, filtered and stockpiled for shipment.

Newcrest - Independent Technical Specialist's Report

Grant Samuel & Associates Pty Ltd

0223041

The expansion is comprised of the addition of a parallel ball milling and cyclone circuit, additional copper flotation capacity, a pyrite rougher flotation circuit processing the copper rougher tails stream, a pyrite concentrate regrind mill, and pyrite cleaner and scavenger cleaner flotation cells.

The flowsheet is shown in Figure 7.15. The initial flowsheet (LEAN) is comprised of the units joined by solid lines and the additional process units for the expansion (Golpu) indicated in the dashed outline.

Figure 7.15 Golpu proposed processing flowsheet

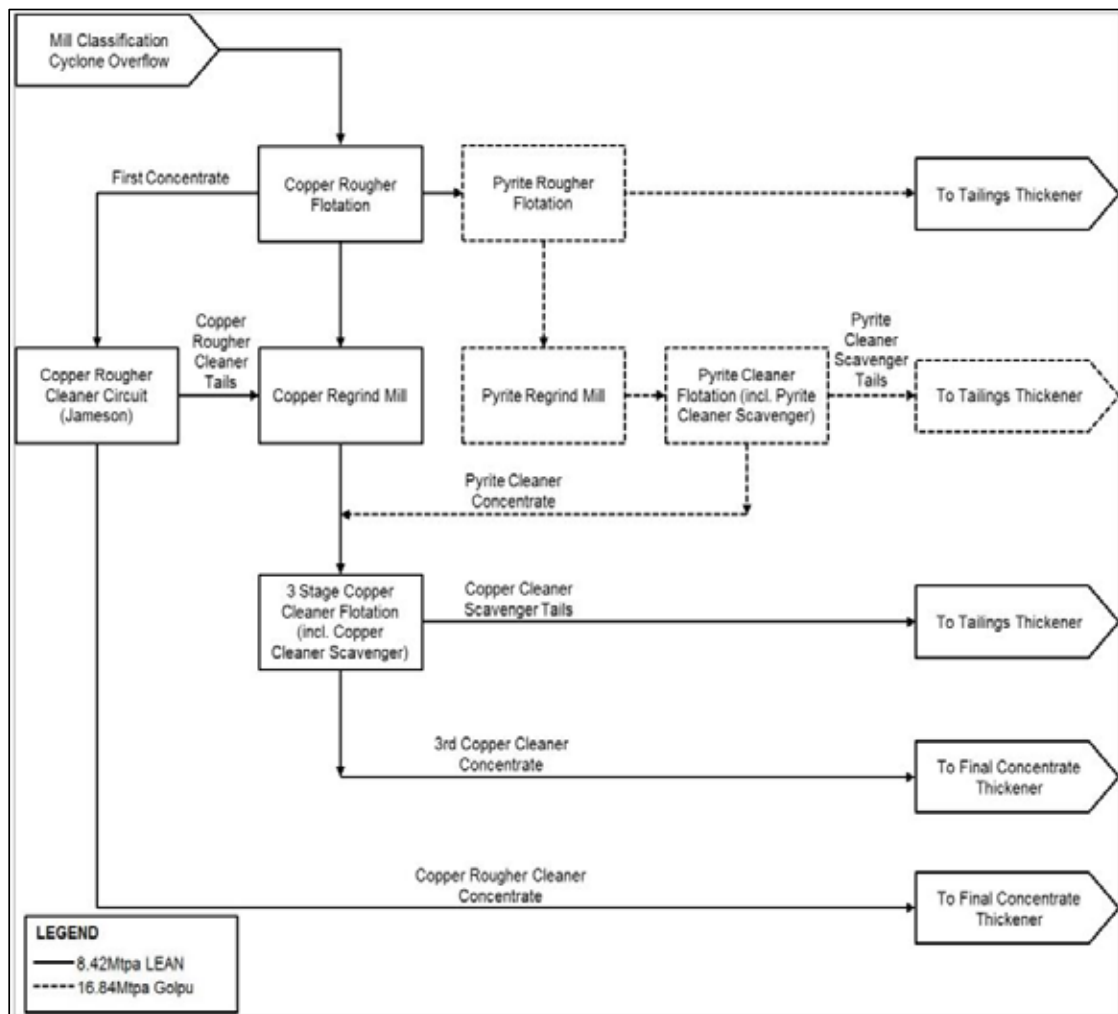

7.5.2 Metal recovery and concentrate grade

Newcrest plans to produce a gold-rich copper concentrate. Forecast LOM grades, recoveries, and contained metal production are as listed in Table 7.9.

Table 7.9 Wafi-Golpu – LOM concentrate production

Element	Grade	Recovery	Metal Production
Au	0.87 g/t	68%	7.6 Moz
Cu	1.23%	95%	4.7 Mt

Annexure 1. Independent Expert's Report

Newcrest - Independent Technical Specialist's Report

Grant Samuel & Associates Pty Ltd

0223041

Forecast annual copper and gold grades and ore milled are shown in Figure 7.16.

Figure 7.16 Wafi-Golpu – forecast annual ore milled

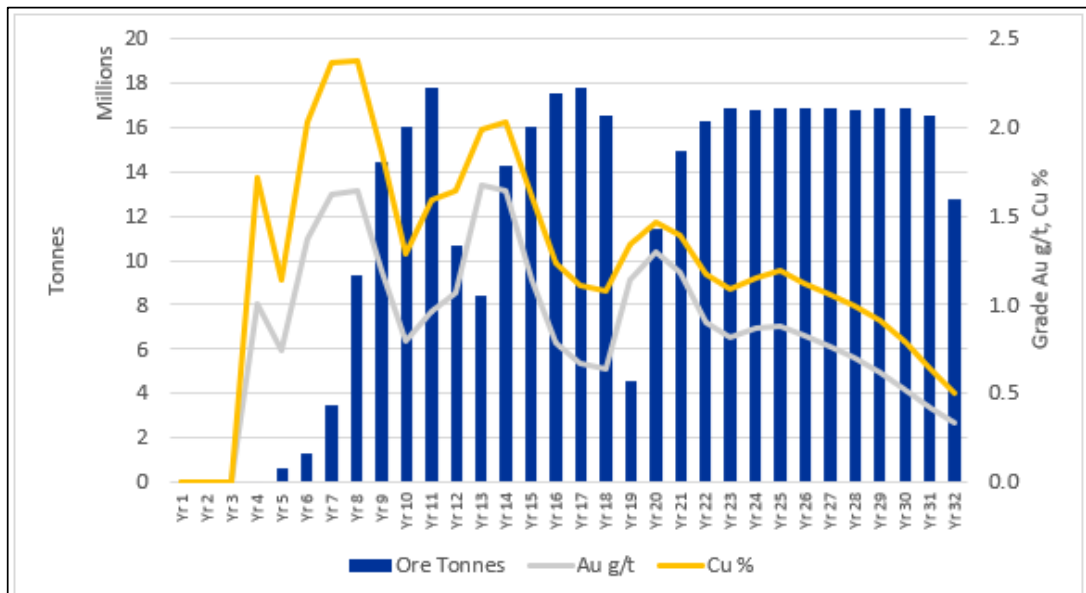

Forecast LOM concentrate grades are as presented in Table 7.10.

Table 7.10 Wafi-Golpu – forecast LOM concentrate grades and tonnes

Cu Grade (%)	Au Grade (g/t)	Concentrate Production (t)
26.6	13.58	17,480,514

Minimum assumed concentrate specifications from the feasibility study are:

Table 7.11 Minimum assumed Golpu concentrate specifications

Description	Specification
Cu grade	>25%
Sulphur grade	<38%
Arsenic	<1000ppm
Fluorine	<300ppm
Transportable moisture	<10.8%

Concentrate produced during the metallurgical testing programme had grades shown in Table 7.12. These are expected to be typical for the operation.

Newcrest - Independent Technical Specialist's Report

Grant Samuel & Associates Pty Ltd

0223041

Table 7.12 Wafi-Golpu - copper concentrate – testwork analysis - major elements

Element	Unit	Value
Cu	%	29.2
Au	ppm	17.0
S	%	30.4
Fe	%	39.4
Ag	ppm	30.0
Mo	ppm	32.0
Si	ppm	150

Other penalty and deleterious elements were measured as below specified limits for concentrate contracts.

7.5.3 Concentrate transport and marketing

Concentrate will be stored in three agitated tanks; each with 8 hours production capacity. The concentrate will be pumped 93km from the processing plant to the port where it discharged to three holding tanks prior to filtration. The concentrate pumping system consists of 2 positive displacement pumps operating in a duty/standby arrangement. The concentrate pipeline will be buried and constructed of steel HDPE lined. The design capacity is 122.7 t/h at a design solids content of 58+/-2% w/w.

The concentrate will be dewatered with a vertical plate and frame pressure filtration press. The combined capacity will be 140 t/h. Filtered concentrate will be discharged to ground for stockpiling by front end loaders.

7.6 Environmental, Social, and Permitting

7.6.1 Environmental and regulatory approvals background

Wafi-Golpu is situated on two Exploration Licences covering approximately 129 km² in total, EL440 (containing the Golpu, Wafi and Nambonga deposits) and EL1105 (held for a range of infrastructure facilities). A Special Mining Lease application (SML10) for the Wafi-Golpu Joint Venture Project was submitted to the MRA in June 2016 and is currently pending approval. Since 2016 a number of other tenements have also been applied for including:

- Four ML applications.
- Five Mining Easements (ME) applications.
- Three Leases for Mining Purposes (LMP) applications.

Newcrest states that an Environmental Permit issued by the CEPA under the *Environment Act 2000* was granted in 2021 and is a pre-requisite for the approval of the SML.

Table 7.13 outlines the tenure and current primary approval applications submitted for the operation and the submission date (if available). At the time of writing, all applications remained outstanding.

Table 7.13 Primary Approval Applications

Regulatory Authority	Details of Application	Application Date
MRA	Special Mining Lease SML10	25 Aug 2016
MRA	Mining Lease ML183 (Northern access road)	19 Sept 2016
MRA	Mining Lease ML184 (Madzim gravel pit)	24 Nov 2021
MRA	Mining Lease ML185 (Lense Sibal Beamena quarry)	24 Nov 2021
MRA	Mining Lease ML186 (South Papas gravel pit)	24 Nov 2021
MRA	Mining Easement ME91 (Pipelines and electricity corridor)	19 Sept 2016

Annexure 1. Independent Expert's Report

Newcrest - Independent Technical Specialist's Report

Grant Samuel & Associates Pty Ltd

0223041

Regulatory Authority	Details of Application	Application Date
MRA	Mining Easement ME92 (Mine access road)	19 Sept 2016
MRA	Mining Easement ME93 (Northern access road)	19 Sept 2016
MRA	Mining Easement ME115 (Madzim gravel pit access road)	24 Nov 2021
MRA	Lease for Mining Purposes LMP100 (Finchif camp)	25 Aug 2016
MRA	Lease for Mining Purposes LMP104 (Concentration filtration plant)	20 Mar 2018
MRA	Lease for Mining Purposes LMP104 (Outfall system)	20 Mar 2018
CEPA	Environmental Permit – Unknown reference, approved 2021	Unknown

Note: LMP 104 application is for the establishment of a Deep Sea Tailings Pipeline and its associated infrastructure. AMC notes there is no marine extension/easement for this infrastructure described in the application, and the tenure application appear to only include the land area.

Included in the lease application for the SML10, was an EIS. This EIS contained a social and environmental impact assessment (EIA) as well as cultural and legal framework considerations and baseline information. The submitted EIS describes the operations and water, tailings disposal, power, processing activities, as well as information on the characterisation and potential impacts to the terrestrial, marine and aquatic environment, and the associated biota from Wafi-Golpu.

AMC notes the following relating to the current primary approval applications and their supporting information:

Water Supply and Management

Management of surface water and groundwater at Wafi-Golpu will require significant management and consideration during construction, operations, closure and post closure, with the area subject to significant annual rainfall (approximately 2,800 mm on average at the mining area), as well as numerous rivers, creeks and springs and groundwater aquifers occurring within the Wafi-Golpu area. Groundwater quantity and quality are matters of high environmental and social sensitivity, with groundwater-fed springs a primary drinking water source for communities in the mine area, and also holding important cultural and spiritual values to local communities. Creeks and rivers within the Wafi-Golpu area also rely on groundwater for baseflow, along with groundwater dependent ecosystems.

Impacts to groundwater quality and quantity that could possibly occur from the Wafi-Golpu activities include flow reduction and drawdown from dewatering in mining, solute migration via seepage of contaminated water, infiltration of poor-quality water from the subsidence zone lake into springs and groundwater features, seepage from landforms and disturbed areas, as well as contamination by spills etc.

AMC notes the potential for spring flows (and the associated ecological and spiritual values) to be permanently altered and long recovery periods predicted for deep regional scale changes to groundwater quantity to occur as residual impacts from Wafi-Golpu. Additionally, residual impacts in the form of changes to fish populations in local rivers and streams are possible.

Deep Sea Tailings Disposal

Disposal of approximately 360 million tonnes of tailings over the life-of-mine will occur via a DSTP pipeline discharging into the marine environment. Originating at the processing plant and extending to an outfall area near Lae and then into the Markham Canyon offshore at a depth of approximately 200 m, the tailings will be mixed with seawater prior to discharge to create a density current that flows down the canyon, eventually to the deep sea New Britain trench, and essentially retaining the tailings below both the euphotic zone and the surface mixed layer of the ocean.

The receiving environment is characterized by highly sediment laden water discharging approximately 60 million tonnes of sediment into the Huon Gulf annually from the large river

Newcrest - Independent Technical Specialist's Report

Grant Samuel & Associates Pty Ltd

0223041

systems and the area is therefore largely absent of sensitive corals and seagrass beds due to the turbidity of the water. Additionally, this reduces the occurrence of fish and the general biodiversity in the nearshore area.

Sampling of the sediments in the rivers draining to the Huon Gulf and the Markham Canyon indicates concentrations of some metals to be elevated compared to natural crustal abundance, including arsenic, copper and nickel in the various rivers; and copper and nickel in the canyon, such that ecotoxicological effects may already be occurring naturally prior to the development of Wafi-Golpu.

AMC notes the proposed outfall area appears suited to the use of DSTP due to the naturally high sediment load already being deposited in the area from existing river, with the tailings expected to mix and co-deposit with the natural riverine sediments. This natural deposition of sediments should assist with burying the tailings post-closure promoting the benthic recovery to pre-mine conditions. The area is also characterised by existing low biodiversity within the coastal areas, canyon and pelagic environments resulting from the natural effects of the riverine sediment load and underwater 'landslides' that occur periodically within the canyon, reducing the potential impacts to biodiversity from the additional deposition of tailings.

AMC also notes the alternative methods of tailings disposal dams or dry stacking of tails are less suitable for Wafi-Golpu, given the high levels of rainfall, steep and unstable terrain, seismicity of the area and significant volumes of tailings proposed to be generated.

Acid and Metalliferous Drainage

The Golpu copper-gold orebody consists of a mineralised core, surrounding by an outer region of high sulphide pyrite and chalcopyrite, and elevated sulphur and arsenic. These characteristics increase the potential development of AMD and associated impacts arising from PAF material being exposed to air and water.

Approximately 2.5 Mt of waste rock (the majority of which is classified as PAF excavated during decline and shaft construction will require a detailed waste landform design to encapsulate problematic waste in NAF materials. The encapsulation material is expected to be sourced during pre-strip of the processing plant terrace and other clay and rock quarries. The estimated ratio of PAF to NAF material to be extracted from mining areas is nearly 4:1 according to the figures in the Feasibility Study and additional material or treatment will be required. AMC notes the tailings metallurgical testwork indicated elevated levels of copper above the ANZECC⁵ water quality guideline limit, although the EIS notes that long term testing under conditions better simulating the ocean environment were underway at the time of its submission and the dilution factors in the EIS have been used to inform the regulatory approved mixing zone boundary for the DSTP system.

AMC notes the EIS describes other management activities to mitigate the effects of AMD such as actively managing PAF materials and run-off of leachate, diversion of clean water around affected areas, interception and application of appropriate treatment (if required) prior to any discharge of water, potential dosing of groundwater in the block caves during inundation of the mine voids during closure; in addition to encapsulation of PAF materials within the landforms.

Energy and Emissions

Power supply for Wafi-Golpu will be provided in a staged approach through a combination of diesel generators and intermediate fuel oil reciprocating engine power generation facility, and mains power (for example, independent supplier at the port facility). Power distribution will be a combination of underground and overhead lines. Wafi-Golpu will require 56 MW per annum

⁵ Australian & New Zealand Guidelines for Fresh & Marine Water Quality.

Newcrest - Independent Technical Specialist's Report

Grant Samuel & Associates Pty Ltd

0223041

power in the first phase, and approximately 100 MW per annum power in the second (peak phase).

WGJV states that air quality modelling indicates that the potential for adverse air quality impacts at two locations (Fly Camp and Ziriruk) due to SO₂ emissions from the IFO power generation facility during the operations phase when under full load. Alternative fuel solutions are being investigated. The WGJV has indicated that air quality monitoring will occur at these locations prior to Phase 2 to verify the modelling and develop management options to meet the adopted air quality criteria.

The average Scope 1 GHG emissions for Wafi-Golpu are estimated at 433,800 tCO₂-e/annum, for a total of 15,182,000 tCO₂-e over the proposed 35-year mine life. Scope 2 emissions account for just 49,000 tCO₂-e/annum or approximately 200,000 tCO₂-e during the 35-year life-of-mine. The total of Scope 1 and Scope 2 emissions will be on average 438,700 tCO₂-e/annum.

AMC notes the majority of these emissions are derived from power generation on site, and diesel combustion in transport as well as land clearing during the construction phase. As the annual GHG emissions exceed 100,000 tCO₂-e, a GHG emissions and Climate Change Risk Assessment will be required.

Culture Heritage and Social Aspects

Since 1996 12 surveys have been undertaken and 351 cultural heritage sites recorded, all located within and broadly surrounding the key project areas (mine, infrastructure corridor and outfall area), including 289 oral tradition sites (comprising former settlements, stories, cemeteries, burial sites, rock shelters, camps), 59 archaeological sites, and 3 historic sites, which Newcrest notes have been used to inform the Cultural Heritage Management Plan. All activities are underpinned by the Land Disturbance Procedure and the Chance Finds Procedure.

Potential impacts to these sites include physical disturbance/destruction, access restriction, modification of the site or surrounding landscape, disturbance to ecosystems that could in turn affect communities' interaction with heritage sites (particularly the effect of groundwater drawdown on sites such as springs and water sources).

While AMC notes that management measures were developed in conjunction with landowners to address and mitigate these impacts, seven cultural heritage sites will still experience significant residual impacts from Wafi-Golpu. All significantly impacted sites are water-related sites on Mount Golpu, and these will be affected by groundwater drawdown and surface subsidence from the block caving. It is to be noted, however, that these impacted sites are also subject to agreed management measures.

Additional social and economic impacts identified in the EIS include both positive and negative effects, some of which can be mitigated through proposed management measures, however residual impacts (while differing in detail according to the various study areas – mine area, infrastructure corridor, outfall area etc) generally include population growth from in-migration, road safety issues, public health impacts associated with high-risk behaviour due to higher levels of disposable income, law and order and land disputes, safety concerns in the post mining landscape (particularly around the subsidence zone), physical displacement and relocation, reduced access to land etc. It is also noted that the communities in the mine area (Study Area 1 of the EIS) are expected to receive the most benefits from Wafi-Golpu however they are also subject to the most residual high-level impacts.

AMC notes that compensation agreements and access agreements with affected landowners and communities are required prior to commencement of operations as requirements under the *Mining Act* 1992. Compensation agreements are in place for exploration activities.

Newcrest - Independent Technical Specialist's Report

Grant Samuel & Associates Pty Ltd

0223041

Biodiversity

Between 2010-2017 baseline surveys on flora and fauna were completed to inform the EIS. The area comprises high biodiversity (885 plant species, 262 terrestrial vertebrate species, 28 freshwater fish species, 8 marine fish species observed in the area) as well as numerous invertebrates. Conservation significant species (marine, freshwater and terrestrial) were identified, including 18 plant species, five terrestrial vertebrate species, one freshwater fish species and one marine species (sea turtle). AMC notes the coastal area near the outfall location comprises internationally recognized Critical Habitat for West Pacific leatherback sea turtles.

Potential impacts to these species from Wafi-Golpu may occur from habitat loss and or degradation, increased interaction with humans (including hunting), death or injury due to mining activities or impacts, invasive species and ecotoxicological effects, etc. AMC notes WGJV has an environmental management system documenting the environmental objectives, criteria, management activities and monitoring required to mitigate the effects of the project on these species, however some residual impacts and cumulative impacts will remain.

Compliance and Regulatory Reporting

Compliance reporting will comprise an annual Environmental Report to be submitted to CEPA each year detailing any significant incidents and non-compliances with legal requirements, as well as any significant aspects and impacts arising during the project development and operations. Additional reporting to National Museum and Gallery of PNG will also be required in the event of discovery of cultural artifacts or sites, however this is ad-hoc and on an as-needs basis. Additional reporting and compliance requirements may be included in the conditions attached the SML and Environmental Permit approvals, however as these items are pending approval, they were not available for review.

Closure Plan

Wafi-Golpu is still in the planning and approval stages, with an approximately 28-year mine life, therefore the closure and rehabilitation considerations are conceptual only. Consideration of rehabilitation and closure matters was included in the EIS submitted as part of the application for the SML in 2016. Key components of the Conceptual Closure and Rehabilitation Plan include:

- Consideration of the national, international and internal WGJV closure guidelines and policies, including the PNG legislation and PNG Mine Closure Policy and Guidelines.
- Consideration of the social and economic setting of Wafi-Golpu and the implications of mine closure on both these aspects both during operations and post closure, such as community dependency on the mine, and appropriate management of social and economic issues related to mine closure.
- The stakeholder engagement requirements and process for agreeing on post closure land use, developing appropriate closure objectives, criteria, refining closure risks and reviewing of closure processes and monitoring.
- General descriptions of decommissioning and progressive rehabilitation activities associated with key domains within the Wafi-Golpu area.
- Monitoring, management and maintenance of the site post closure to ensure compliance with the regulatory requirements and the closure criteria prior to relinquishment of the tenure.

While AMC notes the Plan is conceptual and will undergo detailed revision as operational information and data is accumulated, AMC recognises this introduces a level of uncertainty into the rehabilitation, closure and post closure management requirements. Of particular note, is the potential uncertainty associated with treatment of groundwater and acid and/or metalliferous drainage from the mine area post closure, and WGJV has identified the potential for long-term post-closure treatment requirements to address this issue.

Newcrest - Independent Technical Specialist's Report

Grant Samuel & Associates Pty Ltd

0223041

7.6.2 Closure Cost Estimates

A copy of the closure cost estimate has not been provided for review. AMC notes however that potential management of mine seepage water may require ongoing management and monitoring long-term post-closure, and this could increase the closure cost. AMC also notes the use of deep-sea tailings disposal significantly reduces the closure costs, as the co-deposition of riverine sediments with tailings will ultimately cover the deposited tailings and, over time, assist with returning the deep-sea canyon to close to pre-mining conditions with relatively minimal input in terms of cost to close out this significant aspect of the mine.

7.6.3 Conclusions

While Wafi-Golpu is likely to impact environment and social aspects of the area both during operations and post-closure, these are generally in keeping with the scale and nature of project, and effective and early management of the identified potential impacts will be intrinsic in reducing the residual effects, as well as the long-term cost of the project. Wafi-Golpu will benefit from having a relatively small disturbance footprint given the size and scale of the operation and is likely to yield significant social-economic benefits to the community as well. The proposed environmental and management framework appears robust and appropriate for managing the key issues and impacts, however the final environmental and social criteria to be met are unknown as the Environmental Permit and SML and their attached conditions were not available for review.

7.7 Costs

7.7.1 Operating costs

The Golpu operating estimate is from the 2018 feasibility study rebased in 2021. The operating estimate breakdown is shown in Table 7.14.

Table 7.14 Golpu forecast operating expenditure FY24 to end of LOM

Cost Area	Cost US\$M	Cost US\$ per tonne milled
Mining	1,766	4.42
Processing	3,749	9.38
G&A	2,180	5.45
Concentrate Transport and TCs/RCs	5,158	12.90
Total	12,854	32.15

7.7.2 Capital expenditure

The Golpu capital estimate is from the 2018 feasibility study rebased in 2021. The capital estimate breakdown is shown in Table 7.15.

Newcrest - Independent Technical Specialist's Report

Grant Samuel & Associates Pty Ltd

0223041

Table 7.15 Golpu forecast capital expenditure FY24 to end of LOM

Capital Area	Cost US\$M
Underground mining	2,315
Treatment	993
Shared services and infrastructure	365
Regional infrastructure	281
Site support services	191
Project delivery management	761
Other	289
Provisions	627
Capitalised operating costs	56
Total Non-Sustaining	5,877
Total Sustaining	876
Total Capital	6,753

Note: Golpu capital is 100% basis.

7.8 AMC Production Case1

AMC only developed a single production case for Golpu based on the Newcrest LOMP and consideration of the stated Mineral Resources and Ore Reserves. AMC has made the following key adjustments which are based on reasonable grounds:

- The production case only considers the Golpu underground project.
- Delayed the project by 2 years (Mine development commencing 2027) to allow time for the feasibility study to be updated (previous study completed 2018), funding approval, detailed engineering and completion of project permitting.
- Capital and operating costs were inflated from the 2021 basis to a FY24 basis by a factor of 12.5%. This is the last 2 years Australian CPI (to end of March quarter 2023).

AMC Production Case 1 physicals are summarised in Table 7.16 and costs in Table 7.17

Table 7.16 AMC Production Case 1 – Golpu production schedule

Physical Item	Units	FY27	FY28	FY29 to FY38	FY39 to FY48	FY49 to FY58	FY59 to FY68	Total
Ore Mined	Mt	-	-	72	155	168	4	400
Grade Cu	%	-	-	1.9	1.4	0.8	0.4	1.2
Grade Au	g/t	-	-	1.3	1.0	0.5	0.3	0.9
Ore Milled	Mt	-	-	71	156	168	4	400
Feed Grade Cu	%	-	-	1.9	1.4	0.8	0.4	1.2
Feed Grade Au	g/t	-	-	1.3	1.0	0.5	0.3	0.9
Au Recovery %	%	-	-	75	66	66	60	68.6
Cu Recovery %	%	-	-	95	95	94	94	95
Concentrate Produced	kt	-	-	3,803	7,092	6,448	137	17,481
Copper in Concentrate	kt	-	-	1,260	2,045	1,330	18	4,652
Gold in Concentrate	koz	-	-	2,214	3,415	1,977	26	7,632

Annexure 1. Independent Expert's Report

Newcrest - Independent Technical Specialist's Report

Grant Samuel & Associates Pty Ltd

0223041

Table 7.17 AMC Production Case 1 – Golpu cost schedule

Cost Item	Units	FY27	FY28	FY29 to FY38	FY39 to FY48	FY49 to FY58	FY59 to FY68	Total
Operating Costs								
Mining	US\$M	-	-	400	743	777	70	1,989
Processing	US\$M	-	-	775	1,633	1,724	84	4,216
G&A	US\$M	-	-	621	928	821	82	2,452
Capital Costs								
Growth Capital	US\$M	209	571	5,144	633	84	-	6,641
Sustaining Capital	US\$M	-	-	219	365	365	36	985
Rehabilitation	US\$M	-	-	-	-	-	76	76

7.9 Key risks and opportunities

7.9.1 Risks

In preparing the ITSR, AMC identified the following risks to Wafi-Golpu:

- Various mining related risks such as development rates, cave performance and stress impacts may cause production delays and/or reduced production rates.
- Delays in final approvals and investment decisions for Wafi-Golpu represent the biggest risk to the project. Studies must be updated and a complex approvals process navigated.
- Legal challenges are being processed for the current environmental approvals received for Golpu, these challenges have not been resolved.
- A technical plan for the potential Wafi open pit is only developed at concept level. Significant study and permitting work are required to develop a feasible solution to develop a large open cut resource at the Wafi-Golpu site.
- Potential contamination and drawdown of groundwater and contamination of surface water from AMD, seepage and other mine related sources impacting the biological, physical and social environment, both during project operations and post closure. This risk is defined in the EIS that was reviewed by an independent panel of international experts on behalf of the PNG government as part of the project approval process.
- Potential ecotoxicological effects from groundwater and surface water and tailings disposal on both the freshwater and marine environment.
- Socio-economic and human health-based risks from increased migration, increased disposable income and potential social conflict arising from displacement and resettlement of populations. This risk is defined in the EIS that was reviewed by an independent panel of international experts on behalf of the PNG government as part of the project approval process.
- Loss of biodiversity and habitat due clearing, construction, habitat degradation and tailings disposal, as well as post closure subsidence of the block caves.
- Loss of cultural heritage due to changes to groundwater quality and quantity, disturbance and destruction from mining and related activities. This risk was reviewed by an independent panel on behalf of the PNG government as part of the project approval process.

7.9.2 Opportunities

In preparing the ITSR, AMC identified the following opportunity for Wafi-Golpu:

- The Wafi (gold/silver) and Nambonga (copper/gold) resources have not been included in the current mine plan and may provide additional value to the project in future.

Newcrest - Independent Technical Specialist's Report

Grant Samuel & Associates Pty Ltd

0223041

8 Namosi

8.1 Location and background

Namosi is located in the southeastern part of Viti Levu, the main island of the Republic of Fiji, 30 km west-north-west of the Fijian capital city of Suva (Figure 8.1).

Figure 8.1 Namosi project location.



Copper mineralisation in the Namosi area was first discovered in the 1960s by the Fijian Geological Survey, and exploration in the area has been semi-continuously undertaken by a range of companies. Since the 1960s, exploration has consisted of:

- Surface geochemistry (stream, soil, rock chip and trenching).
- Surface and airborne geophysics (magnetic, ip).
- Geological mapping and related activities.
- RC drillholes and DD.
- Mining, processing and feasibility related studies.

In late 2007, Newcrest signed the Namosi Joint Venture (NJV) agreement with Nittetsu Mining Co. Ltd (Nittetsu) and Mitsubishi Materials Corporation (Mitsubishi) to explore for porphyry copper-gold and epithermal-style gold mineralisation in the Namosi region of Fiji. Newcrest has managed the exploration activities of the joint venture. Newcrest's attributable share of the NJV is 73.03%.

8.1.1 Tenement holdings

Namosi tenure consists of Special Prospecting License 1420 (SPL1420), which covers an area of 824 km² from the south coast to the southeastern central highlands of Viti Levu (Table 8.1).

Annexure 1. Independent Expert's Report

Newcrest - Independent Technical Specialist's Report

Grant Samuel & Associates Pty Ltd

0223041

Table 8.1 Namosi tenements

Tenement Number	Area (ha)	Tenement Type	Tenement Expiry Date	Status of Currency
SPL1420	46,902	Special Prospecting Licence	10 August 2023	live

8.2 Site visit

AMC did not visit Namosi as part of preparing this ITSR.

8.3 Geology and Mineral Resources

The Namosi Mineral Resources consist of estimates for two deposits: Waisoi and Wainaulo. Mineral Resources were reported as at 30 June 2023 from estimates completed in-house by Newcrest in 2017 and 2010 (Table 8.2). The Mineral Resources are reported in 100% terms.

Table 8.2 Namosi Mineral Resources as at 30 June 2023.

Classification	Tonnes Mt (Dry)	Grade		Contained Metal	
		Au (g/t)	Cu (%)	Au (Moz)	Cu (Mt)
Waisoi					
Indicated	1,800	0.11	0.35	6.4	6.3
Inferred	170	0.081	0.27	0.45	0.46
Wainaulo					
Inferred	290	-	0.43	-	1.2

Note: All data reported on a 100% asset basis, Newcrest attributable share 73.03%.

The Waisoi Mineral Resource is potentially mineable by open pit methods and was reported at an NSR cut-off of US\$11/t in a notional constraining shell developed using metal prices of US\$1,400/oz for gold and US\$3.40/lb for copper. The Wainaulo Mineral Resource is potentially mineable by underground block caving methods and has been reported as the entire model contents of a conceptual block cave outline determined using an NSR cut-off of US\$23.20/t incorporating operational and cave setup costs and metal prices of US\$1,400/oz for gold and US\$3.40/lb for copper.

There has been no mining at the Namosi deposits. Ore Reserves are not reported.

8.3.1 Wainaulo deposit

8.3.1.1 Geology

The geology of the Wainaulo area comprises a sequence of Tertiary volcanics and volcanoclastics of the Medrausucu Group (the Namosi Andesite unit) intruded by dioritic porphyry intrusions and dykes of variable composition. The Namosi Andesite dominates surface exposures while the intrusive rocks are occasionally exposed at surface.

A strong east to east-northeast structural trend dominates in the Waivaka corridor and is thought to have controlled the development of mineralised porphyry centres throughout the corridor. This trend is represented by large fault zones, localised faults and elongate intrusions and dykes. This same orientation appears to have been an important control on the development of the Wainaulo intrusions and associated mineralisation.

A concentrically-zoned alteration system is evident from potassic to calc-sodic to distal propylitic assemblages. Sodic and intermediate argillic alteration locally overprints the potassic alteration in the core of the system. A zone of discrete phyllic alteration occurs at the transition from the potassic to the distal propylitic alteration assemblages.

Newcrest - Independent Technical Specialist's Report

Grant Samuel & Associates Pty Ltd

0223041

Copper and gold mineralisation is hosted in and adjacent to the porphyry intrusions, and is dominated by vein-hosted sulphide mineralisation, and lesser fracture fill and disseminated styles. Bornite and chalcopyrite are the dominant copper sulphides observed in fresh rock. Controls on mineralisation are proximity to porphyry intrusions and preferred structural orientations that parallel the broader corridor.

Most of the higher-grade copper mineralisation is associated with sheeted and stockwork quartz-epidote-magnetite ± bornite-chalcopyrite veins found in the core of the deposit. The veins cut pervasive potassic and calc-sodic alteration that has chalcopyrite and bornite occurring as disseminations. The approximate dimensions of the 0.3% Cu mineralised zone are 300 m wide, 700 m across, and 800 m vertically. Mineralisation is open at depth.

Deposit-scale structural disruption truncates high-grade mineralisation. A major fault associated with distinct oxidation (the Hematite Shear) dislocates the main mineralized zone. The fault truncates mineralization, but deeper drilling has identified mineralisation on both sides of the shear zone.

Oxidation is controlled by terrain. Oxidation affects are typically up to 20 m to 25 m in the central valley but increase to 70 m on peripheral slopes. Mineralisation is not significantly affected by oxidation due to the depth at which most of the mineralisation is developed. Lower-grade copper sulphide mineralisation at higher levels is depressed by the oxidation blanket. There is no significant supergene enrichment.

8.3.1.2 Data collection

Drilling

Drillhole data used for the Mineral Resource estimate is mainly based on drilling conducted between May 2009 in January 2010 by the NJV. Data from earlier drill by Nittetsu has been validated where drill core is available. The Mineral Resource estimate is based on 11 drillholes completed by NJV and 9 drillholes completed by Nittetsu for a total of approximately 12,700 assayed samples. Figure 8.2 shows Wainaulo drillhole traces.

Newcrest - Independent Technical Specialist's Report

Grant Samuel & Associates Pty Ltd

0223041

pulp was taken for multi-element analysis by multi acid digest with ICPOES⁶-ICPMS⁷ finish. A 250 g split was retained for fire assay for gold with AAS⁸ finish on a 50 g charge.

There is no material relationship between core recovery and grade.

Drilling by Nittetsu was sampled over 3 m intervals by breaking it into roughly two equally size samples.

Assay quality control

Quality control procedures for NJV drilling include submission of CRMs at frequency of at least 1 in 20 samples, coarse blanks, laboratory pulp duplicates, and umpire laboratory samples. The performance of CRMs in NJV drilling was good overall with no major issues arising. Coarse duplicates returned very good precision for copper but precision for gold was adversely impacted by the low grades. Blind re-submissions and laboratory check analyses were good for copper but gold results were adversely affected by lack of precision at lower grades.

Density determination

Samples for density determination consisted of 100 mm to 200 mm of half core, coated in wax to seal and weighed in air and in water (the Archimedes method). 314 determinations were available for the Mineral Resource estimate.

8.3.1.3 Mineral Resource estimation

Volume model

The mineralization forms a vertically and laterally elongate body extending 600 m wide, 970 m long and 1,000 m vertically. Three sulphide shells were interpreted to represent the mineralization at different intensities. Two inner sulphide shells were based on percentage of logged copper sulphide minerals. The outer of the two shells is represented by 0.2% bornite and 0.5% chalcopyrite and the inner shell 0.5% bornite and 0.75% chalcopyrite. However, following testwork, the internal shells were not used to constrain grade estimation.

An outer sulphide shell represents the first appearance of copper sulphides is used as a constraining boundary for the estimate (Figure 8.3).

⁶ Inductively coupled plasma optical emission spectrometry

⁷ Inductively coupled plasma mass spectrometry

⁸ Atomic absorption spectrometry

Newcrest - Independent Technical Specialist's Report

Grant Samuel & Associates Pty Ltd

0223041

Figure 8.3 Wainaulo copper domains.

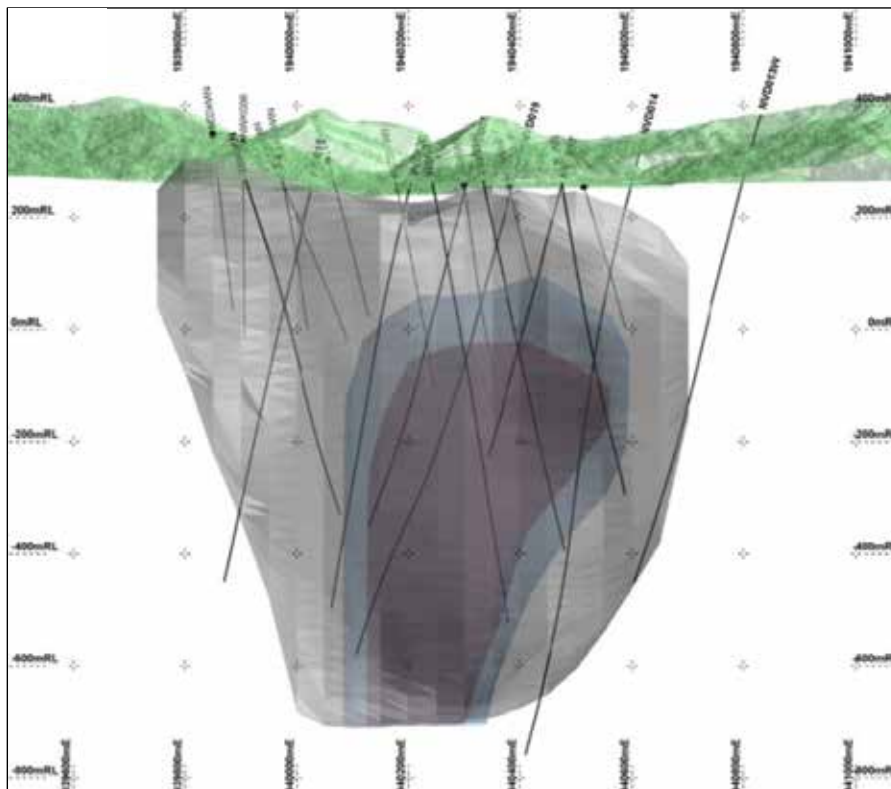

A single barren dyke intersecting mineralization was interpreted.

The volume model parameters used for the resource model are listed in Table 8.3. The parent cell dimensions approximate half the drillhole spacing.

Table 8.3 Volume model parameters.

Parameter	Minimum	Maximum	Model Extent (m)
Easting	1939500	1941000	1,500
Northing	3882300	3882900	600
RL	-700	305	1,005
X Dimension	50	50	-
Y Dimension	50	50	-
Z Dimension	45	45	-

Compositing and grade capping

The dominant sample lengths are 2 m and 3 m and data were composited to 6 m for grade capping and grade estimation. Grade caps were assessed by determining the proportion of metal indicated by composites that within the top 1% of values. The top percentile of composites contributes approximately 7% of the metal indicated by the data and as a result no grade caps were applied.

Newcrest - Independent Technical Specialist's Report

Grant Samuel & Associates Pty Ltd

0223041

Variography and estimation parameters

Gold and copper grades were estimated using OK with an anisotropic search ellipse oriented in the trend of mineralization.

Estimation parameters were based on a study of variography. The search ellipse of 375 m by 280 m by 280 m was defined as 1.5 times the range of the copper variogram. A minimum of 6 and a maximum of 24 composites were allowed for successful estimation with a maximum of 5 composites per drillhole. The internal copper mineralisation domains were not used as hard boundaries in the grade estimation.

Density data (314 determinations) were assessed according to stratigraphy, porphyry unit, and oxidation. For the Mineral Resource estimate, mean densities within each geological domain were assigned to the model:

- Oxide and partial oxide 2.16 t/m³.
- Outside the outer shell 2.66 t/m³.
- Inside the outer shell and outside the innermost sulphide shell 2.70 t/m³.
- Inside the innermost sulphide shell 2.72 t/m³.

Resource classification and reporting

The Wainaulo Mineral Resource estimate is classified as Inferred Resource.

The Wainaulo Mineral Resource is potentially mineable by underground block caving methods and has been reported as the entire model contents of a conceptual block cave outline determined using an NSR cut-off of US\$23.20/t incorporating operational and cave setup costs and metal prices of US\$1,400/oz for gold and US\$3.40/lb for copper.

AMC comments on the Mineral Resource estimate

Drillhole data acquired by NJV demonstrates acceptable data quality. There is less certainty about historic data but it has been validated to the extent possible.

The Mineral Resource estimate has been developed within a single mineralization shell based on the first occurrence of copper sulphides. This is adequate for an estimate classified as Inferred Mineral Resource but a more comprehensive model might be developed with closer-spaced drillhole data.

The parent cell size of the volume model (50 m by 50 m by 45 m) is appropriate for the drillhole spacing and the proposed mining method of block caving. Grade estimation is into parent cells which is appropriate.

Grade estimation used conventional OK with parameters determined from a study of variography. Compositing was appropriate. No grade caps were applied.

Model validation shows copper grades in the model are supported by the data. Gold grades are very low and are not reported as part of the Mineral Resource.

Density was assigned to the block model based on mean values within the copper species domains.

AMC considers that the Mineral Resource classification is appropriate.

The metal prices and costs used to derive Mineral Resource reporting parameters were established in 2018. Updated metal prices and costs may result in a different Mineral Resource being reported from the same underlying resource model.

Newcrest - Independent Technical Specialist's Report

Grant Samuel & Associates Pty Ltd

0223041

AMC considers that the 30 June 2023 Mineral Resource estimate for Wainaulo based on an estimate completed in June 2010 and an evaluation for block caving in 2018 has been completed using accepted industry practices.

AMC considers that the estimate is appropriately classified as Inferred Mineral Resources and that the Mineral Resources reported from this model are acceptable for public reporting in accordance with the JORC Code.

8.3.2 Waisoi deposit

8.3.2.1 Geology

The Namosi porphyry copper-gold deposits occur within a sequence of Tertiary volcanics and porphyritic intrusive rocks located within the main volcanic island of the Fiji Islands group.

The geology of the Waisoi area comprises a Tertiary sequence of volcanics and volcanoclastics which are intruded by dioritic and quartz porphyries and overlain by late Tertiary and Quaternary cover. The Tertiary volcanic sequences include the basement Wainimala Group of basalt to basaltic andesite lavas and auto-brecciated lavas, which are unconformably overlain by the Medrausucu Group consisting of the Basal Namosi Conglomerate, Namosi Andesite sequence, and the younger Korobasabasaga Pyroclastics.

The Wainimala basement and Namosi Andesite sequences are intruded by several quartz-diorite porphyritic intrusions and dykes of similar composition to the Namosi Andesite. Copper and gold mineralisation is hosted within and adjacent to the porphyries.

A zoned alteration system is evident at Waisoi, developed around the major porphyry intrusive centres. A transition from proximal potassic, to strong propylitic, to outer propylitic alteration occurs in the host volcanic sequences and is reflected in intrusive units. Phyllic alteration occurs in the upper parts of porphyry units, possibly overprinting earlier potassic or sodic-potassic events. Silicification may also occur in the core of porphyry intrusive units, above intrusions, or as structurally controlled zones.

Copper and gold mineralisation at Waisoi is hosted within and adjacent to the porphyries and is dominated by disseminated (and fracture fill) bornite and chalcopyrite and to a lesser extent vein-hosted sulphide mineralisation. Controls on mineralisation are variable throughout the deposits, but may be related to alteration type, fracture intensity, faulting/structural complexity, or proximity to porphyry intrusives.

A broad sulphide zonation is evident which grades from an inner chalcopyrite-bornite-pyrite zone, through a broad chalcopyrite-pyrite zone, and outwards to a pyrite±chalcopyrite halo. Gold mineralisation has a close association to copper, and better gold grades often occur in the bornite-chalcopyrite zones.

Oxidation is typically shallow in areas of rapid erosion and deepens along ridges and elevated areas. Total oxidation depths vary from approximately 5 m to 10 m in low lying areas up to 120 m on ridges or in areas where faulting has resulted in deeper infiltration of the oxidation profile. Partial oxidation depths are variable due to the abundance of fracturing and faulting. The partial oxidation profile generally mimics the total oxidation geometry but extends to much greater depths in areas of interpreted faulting.

8.3.2.2 Data collection

Drilling

The geology model for Waisoi was created using 273 holes drilled by previous companies and 64 holes drilled by NJV. The drillhole data used for Mineral Resource estimation includes diamond drill core comprising PQ, HQ, and NQ diameter and RC drilling. Drillhole data available for the

Newcrest - Independent Technical Specialist's Report

Grant Samuel & Associates Pty Ltd

0223041

core which was sampled as quarter core. Drillholes completed by Nittetsu between 2001 and 2007 were sampled over 3 m intervals. Sampling of older drillholes was completed on was on 5 foot and 3 m intervals and also composited over 50 foot and 15 m intervals.

Sampling procedures used by previous companies are not well documented and are considered to be imprecise for at least some of the samples. A statistical review was conducted of the quality of the historic assay data. Core and bulk residue samples from historic ruling have been used for resampling to verify the available historic assays. Historical drillholes for which sampling could not be verified were not used in the Mineral Resource estimate.

Quality control procedures for NJV drilling include submission of CRMs at frequency of at least 1 in 20 samples, coarse blanks, laboratory pulp duplicates, and umpire laboratory samples. A minimum of two CRMs and one blank are included per batch of samples. The performance of CRMs in NJV drilling was good overall with no major issues arising. All CRMs fall within two standard deviations of the certified mean grades. The performance of blanks was fair overall. Analysis of course duplicates returned very good precision for copper and less precise but acceptable precision for gold. Blind resubmissions to the routine laboratory and external laboratory return good results for copper with reproducibility of results comparable to internal duplicate analysis. Gold results are adversely affected by a lack of precision at lower grades but are acceptable overall. No significant laboratory bias is evident.

Assay methods and quality control procedures in historic drillhole data from 1972 to 2001 are highly variable but were consistent with industry practise at that time. Quality control data was routinely collected for all drilling programmes and results from a number of re-sampling and re-assaying programmes have been assessed.

For some drilling programmes, analytical issues were identified but NJV concluded there is no evidence that the global copper estimate resulting from the use of the data is not reliable.

Density determination

Samples for density determination consisted of 100 mm to 200 mm of half core, coated in wax to seal and weighed in air and in water (the Archimedes method). 264 determinations in all oxidation and lithological domains were available for the Mineral Resource estimate.

8.3.2.3 Mineral Resource estimation

Volume model

Waisoi mineralisation cuts across lithological, alteration and oxidation boundaries. The mineralisation is gradational with no apparent hard boundaries and so the estimate has been constrained by generating a wireframe extending 100 m beyond all drillholes. This surface defines the physical limits of the Mineral Resource estimate (Figure 8.5).

Newcrest - Independent Technical Specialist's Report

Grant Samuel & Associates Pty Ltd

0223041

Figure 8.5 Waisoi estimation domain

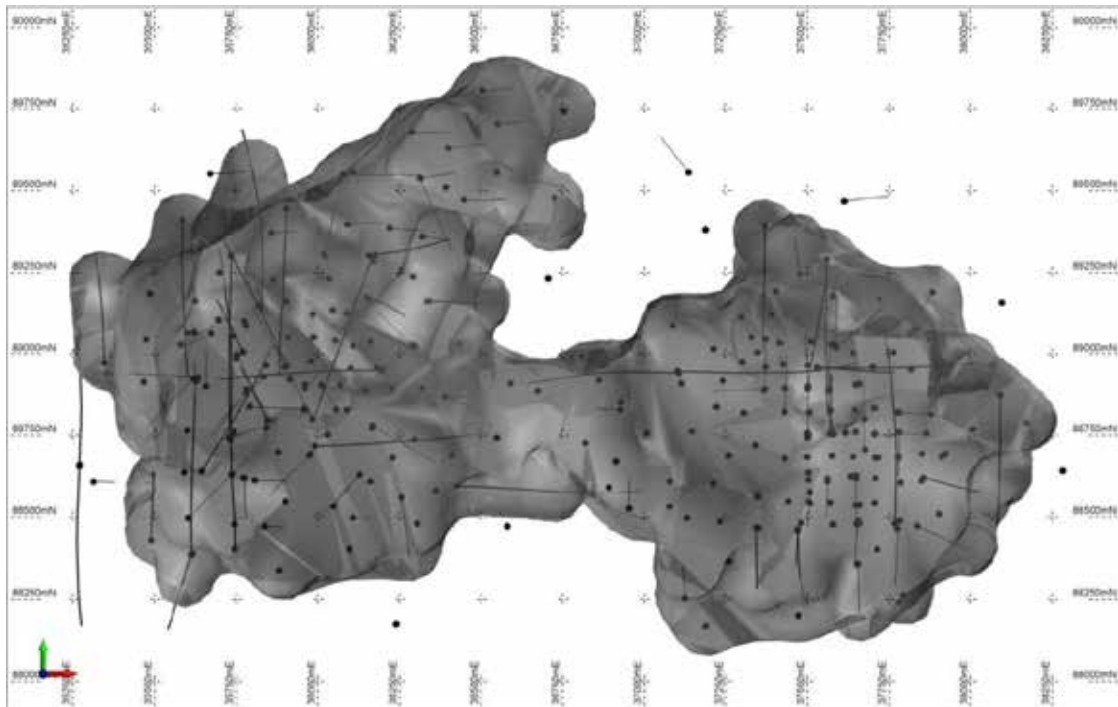

The volume model parameters used for the resource model are listed in Table 8.4.

Table 8.4 Volume model parameters

Parameter	Minimum	Maximum	Model Extent (m)
Easting	34500	38800	4,300
Northing	87000	90500	3,500
RL	4600	5605	1,005
X Dimension	25	25	-
Y Dimension	25	25	-
Z Dimension	15	15	-

Compositing and grade capping

Assays were composited to 15 metres which is the largest assay interval contained in historical drillhole data. No grade caps were applied.

Variography and grade estimation

Copper and gold tonnages and grades were estimated in the non-oxide domains using bivariate uniform conditioning (BVUC). Sulphur and molybdenum were estimated using OK. In the BVUC process, initial estimation is into large panels (100 m by 100 m by 15 m) and a change of support correction applied to adjust to an estimate reflecting the elective mining unit (SMU) (25 m by 25 m by 15 m). The BVUC estimate was subsequently modified to simulate the grade distribution of the panel estimate into model cells of SMU dimensions. The localizing process is based on an OK estimate into SMU-sized model cells that ranks the metal indicated by the BVUC estimate into smaller cells.

Newcrest - Independent Technical Specialist's Report

Grant Samuel & Associates Pty Ltd

0223041

Oxide mineralization is not reported as Mineral Resource and all variables are estimated using OK with hard boundary against non-oxide domains.

Variograms were calculated and modelled for all estimation variables. Raw data were transformed into gaussian space where the variograms were calculated and modelled and the variogram model back transformed into original space.

The search ellipse in the non-oxide domain was 550 m by 550 m by 350 m for copper estimation and 500 m by 500 m by 250 m for gold estimation reflecting the longest ranges of interpreted variogram models.

Density data (264 determinations) were assessed with regard to vein density and sulphide species which determined that density increased toward the centre of the deposit in line with increasing vein density and changes to sulphide species. For the Mineral Resource estimate, mean densities within each sulphide domain were assigned to the model:

- Total oxidation 2.03 t/m³.
- Partial oxidation 2.33 t/m³.
- Wainimala Group 2.63 t/m³.
- Namosi Basal Conglomerate 2.57 t/m³.
- Namosi Andesite 2.55 t/m³.
- Waisoi East Porphyry 2.45 t/m³.
- Waisoi west Porphyry 2.52 t/m³.

Resource classification and reporting

The Waisoi Mineral Resource estimate is classified as Indicated and Inferred Mineral Resource considering drillhole spacing, style of mineralization, data quality, geological and grade continuity, and mining selectivity. Classification has engaged an approach that considers the slope of regression of the estimate compared to the mean weighted distance to informing data points.

The Waisoi Mineral Resource is potentially mineable by large-scale open cut mining with processing of non-oxide material through a flotation plant to produce a concentrate. The Mineral Resource has been reported at an NSR value cut-off of US\$11/t incorporating metallurgical recoveries and cost assumptions and metal prices of US\$1,400/oz for gold and US\$3.40/lb for copper, within a notional constraining shell based on metal prices of US\$1,400/oz for gold and US\$4.00/lb for copper.

AMC comments on the Mineral Resource estimate

Drillhole data acquired by NJV demonstrates acceptable data quality. There is less certainty about historic data but it has been validated to the extent possible.

The Mineral Resource estimate has been developed within a single mineralization shell based on physical limits of drilling. Analysis was conducted on lithology, alteration and occurrence of copper sulphides but no apparent basis for domaining was identified. Oxide material was distinguished from non-oxide material.

The BVUC estimate was conducted into large panels (100 m by 100 m by 15 m) and a change of support correction applied to adjust to an estimate reflecting the SMU (25 m by 25 m by 15 m) which is appropriate for the drillhole spacing and the proposed mining method of large-scale open pit mining.

Grade estimation used BVUC which is not a commonly-used method but is geostatistically sound. Compositing was appropriate. No grade caps were applied.

Newcrest - Independent Technical Specialist's Report

Grant Samuel & Associates Pty Ltd

0223041

Model validation shows copper grades in the model are supported by the data.

Density was assigned to the block model based on mean values within geological and oxidation domains.

AMC considers that the Mineral Resource classification is appropriate.

The metal prices and costs used to derive Mineral Resource reporting parameters were established in 2017. Updated metal prices and costs may result in a different Mineral Resource being reported from the same underlying resource model.

AMC considers that the 30 June 2023 Mineral Resource estimate for Waisoi based on an estimate completed in January 2017 has been completed using accepted industry practices.

AMC considers that the estimate is appropriately classified as Indicated and Inferred Mineral Resources and that the Mineral Resources reported from this model are acceptable for public reporting in accordance with the JORC Code.

8.4 Mining Operations and Ore Reserves

There has been no mining at the Namosi deposits and Ore Reserves are not reported.

8.5 Mineral Processing

Although studied extensively in the past, Newcrest has not provided a processing flowsheet for Namosi and AMC has not reviewed potential processing options.

8.6 Environment, Social, and Permitting

As there are no firm mining and ore processing plans for Namosi, AMC has not reviewed environmental, social, and permitting aspects for Namosi.

8.7 Costs

As there have been no operations at Namosi and there are no firm mining and ore processing plans, AMC has not reviewed proposed operating and capital costs for Namosi.

8.8 AMC production cases

AMC considers that the assessment and development of Namosi has not reached the level of assessment and accuracy required for a production case, and there are no AMC production cases for Namosi.

Therefore, the Mineral Resources at Namosi are valued by AMC along with other Mineral Resources outside of AMC production cases.

8.9 Key risks and opportunities

8.9.1 Risks

In preparing the ITSR, AMC identified the following risks to Namosi:

- Costs estimates used to derive the Mineral Resource are dated, updating these costs may impact the size of the Mineral Resource.

8.9.2 Opportunities

In preparing the ITSR, AMC identified the following opportunity for Namosi:

- Further studies and technological advancements could progress the Namosi project towards the statement of an Ore Reserve and to eventual project development.

Newcrest - Independent Technical Specialist's Report

Grant Samuel & Associates Pty Ltd

0223041

9 Valuation of Exploration Assets

9.1 Valuation methods – Mineral Resources and Exploration Assets

Where projections of production physicals and related costs can be reasonably determined for an operation or development project, it is accepted industry practice (refer Clause 8 of the VALMIN Code) to prepare discounted cash flow (DCF) models from which net present value (NPV) estimates can be determined for the operation or project. Accordingly, production and capital and operating cost projections have been prepared (AMC production cases) for consideration in the generation of NPVs for those operations or projects that are parts of the Mineral Assets.

Where this is not the case, such as in cases where Mineral Resources fall outside the DCF models, or other exploration projects of Newcrest (Exploration Assets), exploration valuation methods are applied. The methods used for valuation of the Exploration Assets are described below.

Mineral Resources reported as at June 2023 that have been excluded from the AMC production cases for the Newcrest operations have been valued using an exploration valuation method.

Similarly, where a project is not sufficiently advanced to provide a reasonable basis for use of the DCF method, those projects have been considered as Exploration Assets for valuation purposes. This approach has been applied to tenements without Mineral Resources.

The valuation of Exploration Assets, particularly those for which Mineral Resources have not been estimated, is carried out using several generally accepted methods, based on available data.

Due to data limitations, it has not been possible, to use more than one method for determining the valuation appropriate to that project. Values are rounded, and outliers in contributing estimates are sometimes excluded.

The preferred value for the valuation ranges presented in this ITSR is the midpoint of the range.

The methods considered in AMC Report for valuation of the Mineral Resources reported as at the relevant date, that have been excluded from the AMC production cases and Exploration Assets of Newcrest are as follows.

9.1.0 The Yardstick Value method

Rules of thumb or Yardstick Values can be used for properties where a Mineral Resource has been quantified. A value per contained metal unit (for example, ounce of gold, tonne of copper, or gold equivalent) is assigned to an actual Mineral Resource or to a preliminary mineralization estimate. A high, mid, and low valuation are generally derived.

9.1.1 The Unit Area method

A value is determined by reference to either actual transactions for the property in question or to recent transactions for projects considered to be similar to those under review (Comparable Transaction). Comparable Transactions are converted to a value per unit area.

9.1.2 The Joint Venture Terms method

Many transactions on exploration tenements are of a farm-in nature and AMC assesses a "cash equivalent" value for them from the terms the "deemed expenditure" on the property at the time of the deal discounted by a time and probability factor for the likelihood that the farm-in will complete its earning requirement. AMC adjusts the resulting value for any other terms of the joint venture and/or for the results of work carried out since the commencement of the farm-in.

9.1.3 The Past Expenditure Method

A Prospectivity Enhancement Multiplier ("PEM") generally between 0.5 and 3.0 is applied to past expenditure which AMC judges to be effective in regard to future prospectivity.

Newcrest - Independent Technical Specialist's Report

Grant Samuel & Associates Pty Ltd

0223041

9.2 Mineral Resources not included in AMC production cases

For the purposes of valuation of the Mineral Assets, AMC considered the portion of the Mineral Resources not in the AMC production cases, referred to as remnant Mineral Resources. The material in the AMC production cases is sourced from the Mineral Resources and typically has a larger or the same tonnage and same grade as the Ore Reserves.

Mineral Resources converted to Ore Reserves have been included in AMC production cases. For some of the cases, remnant Mineral Resources such as Inferred Resources and other mineralization might have been included in the AMC production cases. Alternatively, the remnant Mineral Resources might be sterilized by the mining methods in the AMC production cases or cultural sites overlying the remnant Mineral Resources, or might be at a high risk of not being foreseeably mined.

At Namosi, there are no AMC production cases and the entire Mineral Resource is valued. At Cadia, the remnant Mineral Resources includes Ore Reserves. This unique situation led AMC to apply a separate schedule of production as described in the section below.

The value of Mineral Resources not included in AMC production cases has been considered by rule-of-thumb or Yardstick Values method. A value per contained metal unit determined from comparable transactions was assigned to the contained metal in a Mineral Resource that was not included in an AMC production case. A range of yardstick values was determined to reflect the Mineral Resource classification.

The metal content is determined by calculating the gold equivalent ounces or the copper equivalent tonnage depending on the primary metal present at the project being assessed. Red Chris and Namosi are treated as copper equivalent projects. The remaining projects are treated as gold equivalent projects.

The metal content in the Measured, Indicated, and Inferred classifications are reported separately as different ranges of implied metal values are applied to each classification. For the valuation, AMC determined the metal content of remnant Mineral Resources in the Measured, Indicated and Inferred classifications by deducting the tonnage and grade in the AMC production cases from the tonnage and grade in the Indicated Mineral Resources first, and then Inferred Mineral Resources if more material is scheduled for mining than is contained in the Indicated classification. The Measured material only occurs in stockpiles, and only remnant if stockpiles are not treated in the AMC production cases.

To value Mineral Resources not included in AMC production cases, a search of a subscription database was completed to identify comparable transactions. In assessing the transactions, it was apparent that transactions in Fiji and PNG, for the purposes of assessing the value of Wafi-Golpu and Namosi Mineral Resources, are limited. Only one transaction was recorded. This was in PNG. It had a yardstick value for Mineral Resources compared with transactions in Australia. As such, and with limited other data, AMC has adopted the predominantly Australian transactions, as listed in Table 9.1, as the comparable transaction for determining the yardstick values to apply to Newcrest's properties in the region.

AMC also performed a search of a subscription database to identify comparable transactions for the Canadian projects, as listed in Table 9.2. AMC assessed these projects against the Australian transaction in the same currency and determined that with the exception of a few high value per ounce transactions, the Australian and Canadian comparable transactions were of similar values.

Some of Newcrest's operations or projects are based on both gold and copper deposits. AMC has treated the as gold deposits by determining gold equivalent ounces of metal. This is based on most deposits being predominantly gold or with similar quantities of gold and copper. AMC notes that Newcrest presents its deposits in terms of gold equivalents.

Annexure 1. Independent Expert's Report

Newcrest - Independent Technical Specialist's Report

Grant Samuel & Associates Pty Ltd

0223041

The yardstick values used to derive the valuation of Newcrest's gold-based Mineral Resources outside of the AMC production cases are based on the Australian and Canadian gold projects. The transactions are gold and polymetallic gold-based projects and are considered relevant to the valuation date without adjustment.

Within the Australian and Canadian transactions, there are a limited number of transactions containing large ounces in inventory. As such, AMC performed a search of comparable transactions with large gold resource inventories in other countries, as provided in Table 9.3. This was undertaken as the remnant Mineral Resources at a number of the Newcrest Mineral Assets are larger than most transactions identified. Notably, Cadia hosts a remnant Mineral Resource of over 48 Moz AuEq, Red Chris over 15 Moz AuEq, and Wafi-Golpu over 29 Moz AuEq.

The transaction identified in other countries includes some with Ore Reserves or plans to mine, such as Peru and China, as Cadia includes Ore Reserves as well as Mineral Resources in its remnants outside the AMC production cases. The project identified in Columbia contained the most ounces, approximately 9.5 Moz. However, this is still significantly smaller than the larger Newcrest remnant resources. However, the transactions with large inventories all imply a lower value per ounce than the transactions between 1 Moz and 4 Moz. To value Newcrest's remnant Mineral Resources and Ore Reserves outside the AMC production cases, AMC considered the transactions in the other countries to support the limited data for higher ounce transaction. The ranges applied to the valuation are based on the Australian and Canadian data.

Table 9.1 Gold transactions for tenements with Mineral Resources in Australia and PNG

Date	Project	Buyer	Resource (koz AuEq)	Value (A\$M)	Implied Value (A\$/oz)
PNG					
08/08/2022	Tolukuma Mt Penck	Tempest Minerals	458	25.7	53.0
Australia					
31/05/2019	Bardoc project	Bardoc Gold Limited	549	0.14	0.3
24/01/2018	Bulong project	Black Cat Syndicate Limited	109	0.77	7.1
15/06/2022	Paulsens W Tanami	Black Cat Syndicate Limited	683	46.38	67.9
10/11/2020	Trojan Slate Dam Clinker	Black Cat Syndicate Limited	115	0.49	4.3
21/06/2019	Spargos Reward project	Corona Resources Limited	18.9	0.05	2.5
15/06/2021	Grade Gnaws Nest	Emu NL	13.8	3.28	238.2
13/01/2021	Yandan project	GBM Resources Limited	308	3.24	10.5
15/01/2021	Twin Hills	GBM Resources Limited	633	3.50	5.53
12/01/2021	Kookynie project	Genesis Minerals Limited	414	15.26	36.9
10/02/2021	Bendoc project	Gladiator Resources Limited	16	0.25	15.8
30/12/2021	Manna project	Global Lithium Resources	1096	32.58	29.7
5/11/2020	Kalpini project	Horizon Minerals Limited	256	2.72	10.7
28/06/2019	Mt Adrah project	Investor group	766	0.59	0.8
15/11/2021	Jumbuck project	Marmota Limited	319	3.04	9.5
6/01/2019	Devon mine	Matsa Resources Limited	45.5	0.10	2.2
15/01/2019	Zelica project	Matsa Resources Limited	30	0.15	4.9
24/03/2020	Clonbinane project	Mawson Resources Limited	47	0.62	13.2
1/06/2021	Malcom project	Mt Malcolm Mines NL	14.5	0.37	25.6
14/09/2018	Central Tanami project	Northern Star Resources	412	20.29	49.3
15/09/2021	Central Tanami project	Northern Star Resources	274	16.12	58.8
16/06/2021	Kurnalpi Project	Northern Star Resources	189	19.10	100.8
29/06/2020	Beaconsfield mine	NQ Minerals Plc	57.1	1.81	31.7
16/12/2020	Mathinna/Alberton Lefroy	Nubian Resources Ltd.	45.3	2.38	52.6

Newcrest - Independent Technical Specialist's Report

Grant Samuel & Associates Pty Ltd

0223041

Date	Project	Buyer	Resource (koz AuEq)	Value (A\$M)	Implied Value (A\$/oz)
29/03/2021	Lindsays project	Nu-Fortune Gold Ltd	215	5.10	23.7
24/12/2020	Tuckanarra project	Odyssey Energy Limited	80.7	4.85	60.1
9/07/2019	Central Norseman project	Pantoro Limited	1745	54.24	31.1
25/10/2018	Jungle Well project	PVW Resources NL	17	0.01	0.6
27/05/2020	Cables and Mission	Red 5 Limited	185	2.25	12.1
6/04/2020	Mining Lease M37/54	Red 5 Limited	62.1	2.07	33.4
4/06/2019	Box Well and Deep South	Saracen Mineral Holdings	207	13.26	64.1
23/08/2021	Monument Project	SI6 Metals Limited	50	0.54	10.8
30/09/2020	Leonora tenements	Specrez Pty Ltd	104	0.19	1.8
7/12/2018	Penny West project	Spectrum Metals Limited	36	0.89	24.8
17/12/2021	Millrose project	Strickland Metals Limited	346	10.31	29.8
1/10/2020	Eureka project	Warriedar Mining	43.1	1.41	32.7
8/05/2020	Albury Heath project	Westgold Resources Limited	27	1.13	41.7

Source: S&P Global Inc.

Table 9.2 Gold transactions for tenements with Mineral Resources in Canada

Date	Project	Buyer	Resource (koz AuEq)	Value (A\$M)	Implied Value (A\$/oz)
21/07/2021	Dome Mountain project	Blue Lagoon Resources Inc.	39	0.43	11.03
16/12/2020	Newton project	Carlyle Commodities Corp.	1,571	1.48	0.94
6/10/2021	Thundercloud project	Dynasty Gold Corporation	182	2.43	13.37
31/03/2021	Tag property	Engineer Gold Mines Ltd.	63	1.13	17.94
16/04/2021	Hardrock project	Equinox Gold Corp.	593	75.00	126.54
9/12/2020	East Cedartree claims	First Mining Gold Corp.	188	4.81	25.54
16/03/2020	Lac Fortune property	Globex Mining Enterprises Inc.	39	0.07	1.83
25/11/2020	Brady project	Gold'n Futures Mineral Corp.	939	0.88	5.09
31/05/2021	Moss Lake gold project	Goldshore Resources Inc.	3,989	59.94	15.03
8/06/2020	Fayolle property	IAMGOLD Corporation	111	12.25	110.35
10/11/2020	Monster Lake project	IAMGOLD Corporation	108	9.73	89.86
29/01/2021	Slip and Victoria Lake	International Montoro Resources Inc.	78	0.08	0.99
31/12/2020	Fenn-Gib Property	Mayfair Gold Corp.	2,050	16.18	7.89
14/09/2022	Berens River project	Midex Resources Ltd.	43	1.69	39.26
31/08/2020	Northshore property	Omni Commerce Corp.	535	0.28	0.52
18/08/2020	Northshore Property	Omni Commerce Corp.	680	1.51	2.22
20/04/2020	Sidace Lake property	Pacton Gold Inc.	142	3.00	21.11
6/01/2020	Gold Shear property	PJX Resources Inc.	22	0.09	3.92
24/03/2020	Monique property	Probe Metals Inc.	661	1.31	1.99
14/05/2021	Roger project	QC Copper and Gold Inc.	228	2.33	10.22
30/03/2021	Wawa project	Red Pine Exploration Inc.	257	15.10	58.71
27/01/2021	Manson Bay Property	SKRR Exploration Inc.	66	0.34	5.16
30/06/2020	Juby project	South American Resources Corp.	3,999	13.97	3.49
27/04/2020	Nudulama claims	South Shore Partnership Inc.	54	0.08	1.55
29/12/2020	Newman Todd project	Trillium Gold Mines Inc.	37	3.03	82.82
8/03/2023	Rowan Property	West Red Lake Gold Mines Ltd.	232	1.72	7.41

Annexure 1. Independent Expert's Report

Newcrest - Independent Technical Specialist's Report

Grant Samuel & Associates Pty Ltd

0223041

Table 9.3 Large gold transactions for tenements with Mineral Resources in other countries

Date	Project	Country	Buyer	Project Resource (koz AuEq)	Resource acquired (koz AuEq)	Value (A\$M)	Implied Value (A\$/oz)
31/05/2019	Kiaka	Burkina Faso	West African Resources Limited	6,800	6,180	133.6	21.8
1/06/2021	Lagunas Norte	Peru	Boroo	4,800	4,800	65	13.5
19/07/2022	Sawaya'erden	China	Zijin Mining	3,840	3,840	100	26.0
7/02/2023	Giro	DR Congo	Mabanga	4,400	2,430	44.9	18.4
22/03/2022	Soto Norte	Columbia	Aris Gold	9,475	1,895	147	77.6
27/06/2022	Kouri Babonga	Burkina Faso	BAOR SARL	2,000	2,000	22.8	11.4

The implied values per ounce are compared with the size of the deposits in Figure 9.1. Transactions fall within the range of A\$10 to A\$110 per ounce of contained metal excluding outliers. The implied value does not appear to be influenced unduly by deposit size or continent, although large deposits, particularly in Canada and other countries had low values per ounce.

Figure 9.1 Yardstick value and deposit size for gold transactions in Australia and Canada and in other countries for deposits with large resource ounces.

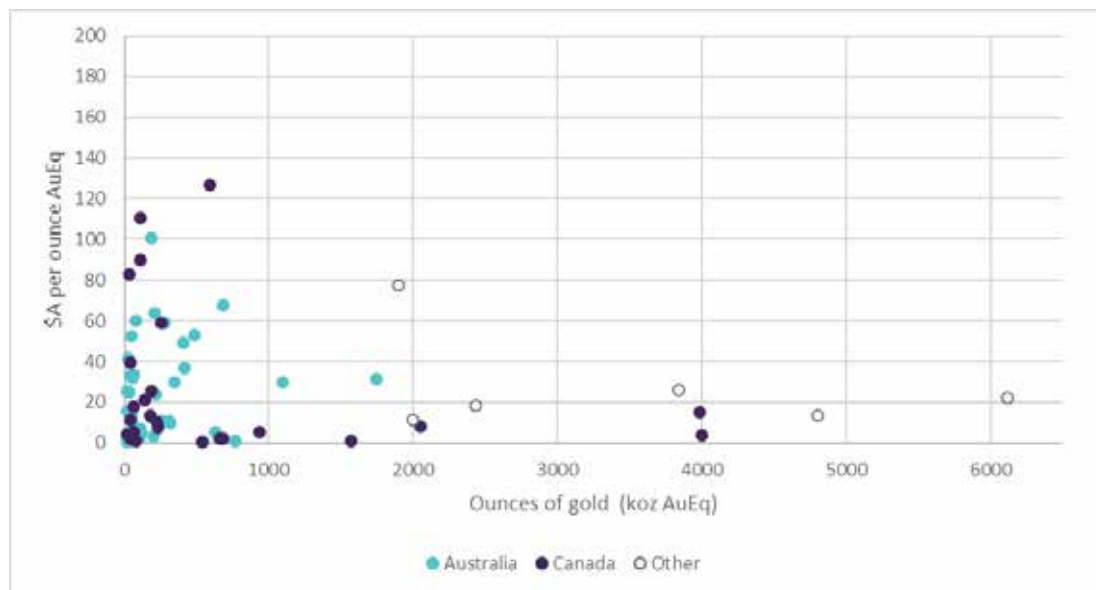

Source: AMC analysis of public information

The Mineral Resources that are subject to the transactions vary in size, mining status and relative proportion of Measured, Indicated, and Inferred Resources. The Mineral Resource estimates to which the yardstick values will be applied are Measured, Indicated, and Inferred.

Implied values, excluding the outliers, are indicated by the transactions to assign ranges of values to be applied to the projects are Measured, Indicated, and Inferred Resources.

Figure 9.2 shows the basis of the ranges of values for Measured, Indicated, and Inferred Resources. From this data, and AMC experience, the ranges of yardstick values applied to each Mineral Resource category are:

- Measured Resource: A\$40/oz to A\$90/oz.
- Indicated Resource: A\$20/oz to A\$40/oz.
- Inferred Resource: A\$1/oz to A\$20/oz.

Newcrest - Independent Technical Specialist's Report

Grant Samuel & Associates Pty Ltd

0223041

To determine the amount of gold equivalent (AuEq) metal at each site, AMC has applied the parameters provided by Grant Samuel and the following equation to determine gold equivalent tonnes at each site:

- $\text{AuEq oz} = \text{Au oz} + ((\text{Cu t} * (\text{Cu US\$/t}) + (\text{Ag oz} * (\text{Ag US\$/oz})) + (\text{Mo t} * (\text{Mo US\$/t})) / (31.103478 * \text{Au US\$/oz}))$
- Cu US\$/t = US\$8,750
- Au US\$/oz = US\$1,950
- Ag US\$/oz = US\$22.00
- Mo US\$/t = US\$11.50
- A\$1.00/US\$0.68

Figure 9.2 Ranges of values assigned for Measured, Indicated, and Inferred gold resources based on Australian and Canadian transactions

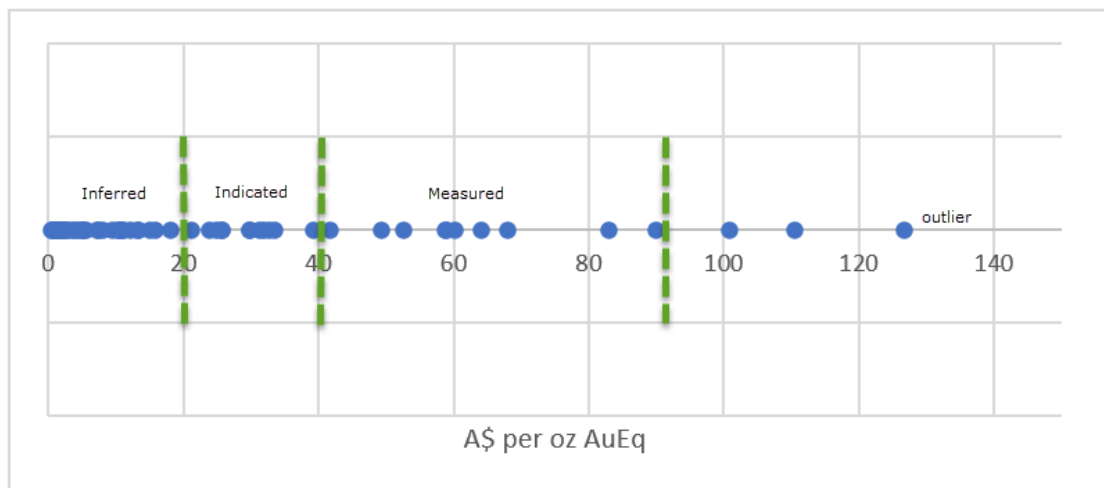

Source: AMC analysis of public information

AMC also considered transactions of copper-based resources. Newcrest documents present Red Chris as a gold equivalent deposit. However, the revenue from copper is greater than gold from Red Chris. Namosi is also a predominantly copper deposit. The Waisoi deposit contains Indicated and Measured Mineral Resources for copper and gold, and Wainaulo contains Inferred Mineral Resources for copper only.

As such, AMC undertook a search of a subscription database to identify comparable transactions for copper resources. AMC considered transactions in Australia, as it did for the gold resource transactions above. Based on this search, the implied values per tonne of copper are compared with the size of the deposits in Figure 9.1. The implied value per tonne does not appear to be influenced by deposit size. A second search was undertaken to identify comparable transactions for copper resources in Canada. This identified a larger population with a similar distribution of transaction sizes and range of values per tonne of copper as seen in Australia.

Annexure 1. Independent Expert's Report

Newcrest - Independent Technical Specialist's Report

Grant Samuel & Associates Pty Ltd

0223041

Figure 9.3 Yardstick value and deposit size for copper transactions Australia

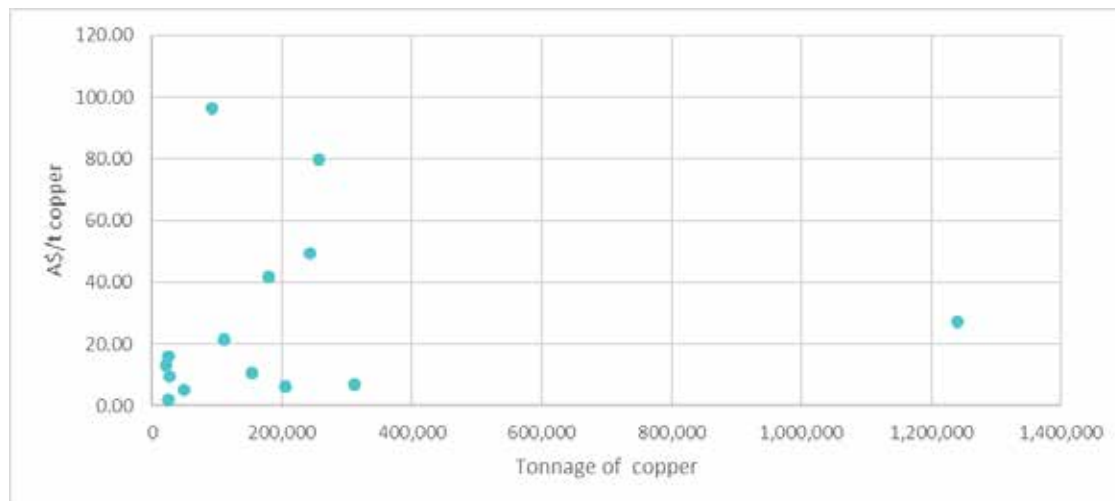

Source: AMC analysis of public information

The Mineral Resources that are subject to the transactions vary in size, mining status, and relative proportion of Measured, Indicated, and Inferred Resource. Implied values indicated by the transactions, excluding the outliers, are used to assign ranges of values to be applied to Measured, Indicated, and Inferred Resources.

Figure 9.4 shows the basis of the ranges of values for Measured, Indicated, and Inferred Resources. From this data, and AMC experience, the ranges of yardstick values applied to each Mineral Resource category are:

- Measured Resource: A\$60/t CuEq to A\$100/t CuEq.
- Indicated Resource: A\$30/t CuEq to A\$60/t CuEq.
- Inferred Resource: A\$5/t CuEq to A\$30/t CuEq.

Figure 9.4 Ranges of values assigned for Measured, Indicated, and Inferred copper resources based on comparable transactions

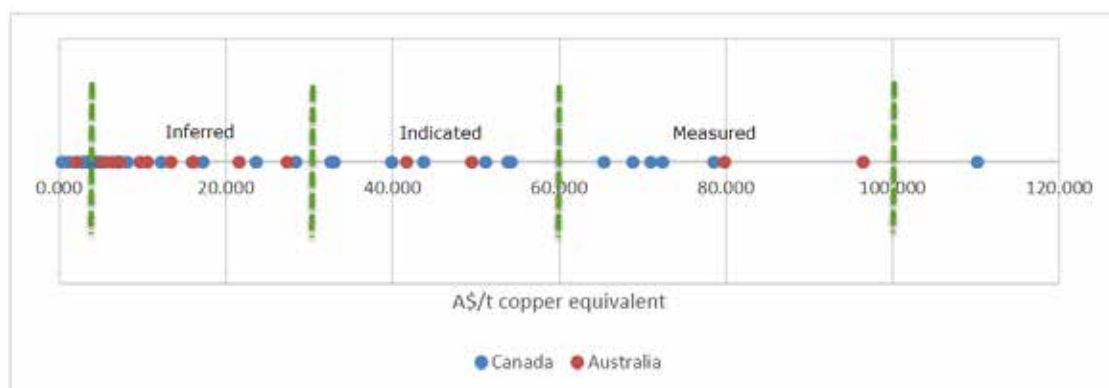

Source: AMC analysis of public information

Newcrest - Independent Technical Specialist's Report

Grant Samuel & Associates Pty Ltd

0223041

9.2.1 Cadia

Cadia is a unique situation given the combination of the large scale of underground mining, mine life, and remnant Mineral Resources (that is, the Mineral Resources outside the currently scheduled mine life).

Because of the unusually large tonnage and metal content of the remnant Mineral Resources, there are not comparable transactions to indicate yardstick values for inventories of such magnitudes. Therefore, there are not yardstick values that are relevant to the Ore Reserves and Mineral Resources that are not practically accessible until after FY50.

Accordingly, AMC considers that the Yardstick Value method applied by AMC to Newcrest's other remnant Mineral Resources is not an appropriate method for valuing the remnant Mineral Resources at Cadia, given their unique nature.

Cadia's uniqueness can be summarised as follows:

- The Newcrest LOMP and AMC production cases have long lives, that is, production is scheduled to FY50.
- The Ore Reserves total 1,280 Mt, however, the AMC production cases only include ore milled of 895 Mt, leaving Ore Reserves of 385 Mt outside the AMC production cases (refer sections 2.5 and 2.10 of this ITSR).
- The remnant Mineral Resources total approximately 2,479 Mt grading 0.29 g/t Au and 0.22% Cu (refer section 9.2 of this ITSR). This incorporates the Mineral Resources from which the 385 Mt of Ore Reserves that are not scheduled in the AMC production cases were derived.

AMC's assessment of the remnant Mineral Resources is that they represent additional value if scheduled as an extension to the AMC production cases at the production rate of 35 Mtpa. Therefore, AMC considers that for the production rate of 35 Mtpa as scheduled for the AMC production cases, there is a feasible extension to mine life of approximately 60 years beyond the AMC production cases based on the remnant Mineral Resources.

To reflect the decades of delay before the remnant Mineral Resource become practically available for mining, and the likely exceptionally long extension to mine life they indicate, AMC considers that a discounted cash flow approach is warranted to reflect the time aspect inherent in a valuation of the remnant Mineral Resources.

Accordingly, AMC scheduled an extension to production from the remnant Mineral Resource after the AMC production cases. In those schedules, AMC:

- Reduced the tonnage of the remnant Mineral Resources by 15% to allow for what is reasonably likely to be economic and recoverable for panel cave mining by Newcrest.
- Used the average grades of the remanent Mineral Resources for all years.
- For the years that the remnant Mineral Resources are scheduled, increased the annual operating costs by 10% over and above the annual average for the AMC production cases to allow for the remnant Mineral Resources being potentially further away from infrastructure than is the situation for the AMC production cases.
- For the years that the remnant Mineral Resources are scheduled, increased the annual rate of capital expenditure by 10% over and above the annual average for the AMC production cases to allow for gradual replacement of major equipment in the processing plant and associated production infrastructure during 60 years of production from the remnant Mineral Resources beyond 2050.

AMC provided those schedules to Grant Samuel as the basis for a discounted cash flow analysis of those schedules.

Annexure 1. Independent Expert's Report

Newcrest - Independent Technical Specialist's Report

Grant Samuel & Associates Pty Ltd

0223041

Grant Samuel applied commodity prices, tax, and discount rates to those schedules for the discounted cash flow analysis. The metal prices applied range from US\$1,900 to US\$2,000 per ounce of gold, and US\$8,250 to US\$8,750 per tonne of copper, and the nominal discount rates applied range from 8% to 9% per annum.

Grant Samuel advised AMC of the results of the discounted cash flow analysis. Using those results, AMC prepared the range of values presented in Table 9.4 and Table 9.5.

AMC considers that the range of values for the remnant Mineral Resources presented in Table 9.4 and Table 9.5 has a sound basis and reasonably and appropriately reflects the inherent timing aspects and magnitude of the unique situation at Cadia.

Table 9.4 Valuation of Mineral Resources outside Cadia AMC Production Case 1

Case	Metal Price	Discount Rate	Value (US\$M)
AMC low case	Low	High	266
AMC high case	High	Low	584
AMC preferred case	Midpoint	Midpoint	401

Table 9.5 Valuation of Mineral Resources outside Cadia AMC Production Case 2

Case	Metal Price	Discount Rate	Value (US\$M)
AMC low case	Low	High	367
AMC high case	High	Low	737
AMC preferred case	Midpoint	Midpoint	525

9.2.2 Telfer-Havieron

Telfer-Havieron Mineral Resources comprise the underground resources at Telfer and Havieron, the West Dome open pit and the Telfer open pit stockpile upon which the AMC production cases are based. In addition, there are Satellite deposits and Camp Dome. AMC has separated O'Callaghans due to the tungsten, zinc, and lead present.

AMC considered the predominantly gold resources with some copper, and O'Callaghans, in terms of gold equivalent values.

For the valuation of the remnant Mineral Resource at Telfer-Havieron, AMC calculated the portion of Mineral Resources that are not included in the AMC production cases from the deposits listed above. AMC considers the AMC production cases as Probable Ore Reserve being sourced from the Measured Mineral Resources first then Indicated, and from the stockpiles. Any remainder is considered as being Mineral Resource outside of the AMC production cases for the purpose of the valuation.

The total value for the Mineral Resources at Telfer-Havieron outside AMC Production Case 1 as determined by the Yardstick Value method is between A\$388M and A\$853M with a preferred value of A\$620M, and for AMC Production Case 2, between A\$390M and A\$855M with a preferred value of A\$622M.

At O'Callaghans, AMC used data provided by Newcrest to determine commodity prices for zinc, and lead. The tungsten price was based on a range of values in several sources provided by Newcrest. AMC applied the following prices:

- WO₃ US\$/lb = US\$320/lb
- Zn US\$/lb = US\$1.125/lb
- Pb US\$/lb = US\$0.987/lb
- A\$1.00/US\$0.68

Newcrest - Independent Technical Specialist's Report

Grant Samuel & Associates Pty Ltd

0223041

The total value for the Mineral Resources at Telfer-Havieron and O'Callaghans outside AMC Production Case 1 as determined by the Yardstick Value method is between A\$118M and A\$315M with a preferred value of A\$217M and, for AMC Production Case 2, is between A\$65M and A\$198M with a preferred value of A\$132M as presented in Table 9.6.

Table 9.6 Valuation of Mineral Resources outside Telfer-Havieron AMC production cases

Case	Measured Resource (koz AuEq)	Indicated Resource (koz AuEq)	Inferred Resource (koz AuEq)	Low (A\$M)	Preferred (A\$M)	High (A\$M)
Outside AMC Production Case 1						
Telfer	-	2,106	1,361	43	77	111
Havieron	-	1,588	2,924	35	78	122
O'Callaghans	-	1,987	128	40	61	82
Case 1 Total	-	5,681	4,413	118	217	315
Outside AMC Production Case 2						
Telfer	-	1,057	1,361	23	46	70
Havieron	-	0	2,346	2	25	47
O'Callaghans	-	1,987	128	40	61	82
Case 2 Total	-	3,044	3,835	65	132	198

9.2.3 Lihir

Lihir comprises a large single open pit operation. The valuation of the Mineral Resources outside the AMC production cases is based on the production cases which draw on Indicated Mineral Resources and stockpiles. The valuation also considers that the Lihir Mineral Resource estimate is reported within a pit shell that includes the Alaiya Rock, which is a cultural heritage site above the resource. AMC's conceptual assessment indicates that in the order of 50% of the Mineral Resource estimate is impacted by the presence of Alaiya Rock. As such, AMC applied a 50% discount to the valuation of the Mineral Resources outside the AMC production cases at Lihir using the Yardstick Value method.

The total value for the Mineral Resources at Lihir outside AMC Production Case 1 and AMC Production Case 2 as determined by the Yardstick Value method is between A\$202M and A\$448M with a preferred value of A\$325M as presented in Table 9.7.

Table 9.7 Valuation of Mineral Resources outside Lihir AMC production cases

Case	Measured Resource (koz AuEq)	Indicated Resource (koz AuEq)	Inferred Resource (koz AuEq)	Low (A\$M)	Preferred (A\$M)	High (A\$M)
Outside AMC Production Case 1	-	19,940	4,880	202	325	448
Outside AMC Production Case 2	-	19,940	4,880	202	325	448

9.2.4 Red Chris

Red Chris will be mined from the open pit and from the East Zone block cave.

The East Ridge exploration target, a potential extension of the current Mineral Resource is proposed to be the subject of a strategic study in CY24 following the planned release of a maiden Mineral Resource in late 2023. AMC understands that some material from East Ridge has been included in the Newcrest LOMP for Red Chris.

For the purposes of the valuation AMC has depleted the Indicated Mineral Resources reported for Red Chris open pit and underground. AMC has used the Yardstick Value method to value the

Annexure 1. Independent Expert's Report

Newcrest - Independent Technical Specialist's Report

Grant Samuel & Associates Pty Ltd

0223041

remnant Mineral Resources. AMC considers that this takes into account the values of exploration targets such as East Ridge, and that any value exploration targets might have is included in the range of values for the remnant Mineral Resources. AMC considered the valuation based on comparable transactions with both gold equivalent and copper equivalent metal content and applied the mid-point of the preferred values implied by the Yardstick Value method for each metal equivalent.

There is a significant amount of remnant Mineral Resources at Red Chris. However, AMC also anticipates some of the remnant resource will be sterilised in both AMC production cases, as it will not be possible to recover resources adjacent to the block cave. AMC considers this will be approximately 10% of the remnant Indicated and Inferred Resources at Red Chris for each of the AMC production cases. As such, AMC has discounted the calculated valuations by 10% to account for these inaccessible ounces.

The total value for the Mineral Resources at Red Chris outside AMC Production Case 1 as determined by the Yardstick Value method for gold and copper is between A\$71M and A\$480M as presented in Table 9.8, with a preferred value of A\$229M, being the mid-point between the preferred values for gold and copper.

The total value for the Mineral Resources at Red Chris outside AMC Production Case 2 as determined by the Yardstick Value method for gold and copper is between A\$26M and A\$205M as presented in Table 9.8 with a preferred value of A\$92M, being the mid-point between the preferred values for gold and copper.

Table 9.8 Valuation of Mineral Resources outside Red Chris AMC production cases

Gold Equivalent	Measured Resource (koz AuEq)	Indicated Resource (koz AuEq)	Inferred Resource (koz AuEq)	Low (A\$M)	Preferred (A\$M)	High (A\$M)
Outside AMC Production Case 1	-	11,126	4,396	204	342	480
Outside AMC Production Case 2	-	3,508	4,396	67	136	205
Copper Equivalent	Measured Resource (kt CuEq)	Indicated Resource (kt CuEq)	Inferred Resource (kt CuEq)	Low (A\$M)	Preferred (A\$M)	High (A\$M)
Outside AMC Production Case 1	-	2,479	980	71	116	160
Outside AMC Production Case 2	-	782	980	26	47	69

9.2.5 Brucejack

Brucejack is to be mined by underground stoping methods. The grades applied to the AMC production cases are significantly lower than the reported grades for the Mineral Resources as there is significant dilution anticipated during mining.

The total value for the Mineral Resources at Brucejack outside the AMC Production Case 1 as determined by the Yardstick Value method is between A\$97M and A\$267M with a preferred value of A\$182M and, for AMC Production Case 2 is between A\$27M and A\$128M with a preferred value of A\$77M as presented in Table 9.9.

Newcrest - Independent Technical Specialist's Report

Grant Samuel & Associates Pty Ltd

0223041

Table 9.9 Valuation of Mineral Resources outside Brucejack AMC production cases

Case	Measured Resource (koz AuEq)	Indicated Resource (koz AuEq)	Inferred Resource (koz AuEq)	Low (A\$M)	Preferred (A\$M)	High (A\$M)
Outside AMC Production Case 1	-	4,660	4,050	97	182	267
Outside AMC Production Case 2	-	1,170	4,050	27	77	128

9.2.6 Namosi

Namosi is a predominantly copper deposit. The Waisoi deposit contains Indicated and Measured Mineral Resources for copper and gold, and Wainaulo contains Inferred Mineral Resources for copper only.

The Mineral Resource estimates to which the yardstick values will be applied are Indicated and Inferred. However, Newcrest has not undertaken any activities at Wainaulo since 2010 and at Waisoi since 2013. The Waisoi Mineral Resource estimates was updated in 2017 based on data collected before 2013.

Further, although there is an Indicated Mineral Resource, Newcrest no longer reports an Ore Reserve for Waisoi. AMC considers therefore that the reasonable prospects for eventual economic extraction are diminished. As such, AMC considers all the Mineral Resources at Namosi to be Inferred for the purposes of determining a value of remnant Mineral Resources.

AMC has determined the copper equivalent for the resources using the copper and gold prices provided earlier.

The total value for the Mineral Resources at Namosi for both AMC Production Case 1 and AMC Production Case 2 are calculated based on AMC not having production cases, and therefore there is no value attributed to resources at Namosi elsewhere. The valuations of Namosi Mineral Resources as determined by the Yardstick Value method is between A\$48M and A\$286M with a preferred value of A\$167M as presented in Table 9.10.

Table 9.10 Valuation of Mineral Resources outside Namosi AMC production cases

Case	Measured Resource (kt CuEq)	Indicated Resource (kt CuEq)	Inferred Resource (kt CuEq)	Low (A\$M)	Preferred (A\$M)	High (A\$M)
Outside AMC Production Case 1	-	-	9,523	48	167	286
Outside AMC Production Case 2	-	-	9,523	48	167	286

9.2.7 Wafi-Golpu

Wafi-Golpu Mineral Resources comprise the Indicated and Inferred Mineral Resources for gold and copper at Golpu and for gold only at Wafi and Inferred Mineral Resources for gold at Nambonga. The two AMC production cases are the same, with both depleting a large proportion of the copper at Golpu. Wafi and Nambonga do not contain copper. As such, AMC considered the resources in terms of gold equivalent values. The gold equivalents also include the silver and molybdenum reported by Newcrest.

Although Wafi-Golpu has a reported Mineral Resource and Ore Reserve, the Ore Reserve is based on the 2018 Feasibility Study with gold price and exchange rates updated in 2023. It is AMC's view that the 2018 Feasibility Study will need to be fully updated according to 2023 cost estimates prior to implementing the project.

Annexure 1. Independent Expert's Report

Newcrest - Independent Technical Specialist's Report

Grant Samuel & Associates Pty Ltd

0223041

Since the 2018 Feasibility Study, Newcrest reported that in March 2021 the relevant governor commenced action against the State of PNG and, in December 2022, Huon Gulf villagers also commenced action against the State of PNG. Both these matters pertaining to the granting of the environmental permit for Wafi-Golpu are reported by Newcrest as being not yet resolved.

These matters, combined with the requirement for feasibility study updates pose a significant challenge to the project advancing as scheduled. The project has been known about by Newcrest, but not developed for many years. There is significant work required before the project would be implemented, including approvals, and study and engineering updates, and then construction. As such, AMC considers the market value of Wafi-Golpu is the value represented by the AMC production cases, and that value covers the value of the Ore Reserves as well as any remnant Mineral Resources outside the AMC production cases. Accordingly, AMC considers that it does not have a reasonable basis to attribute a material value to remnant Mineral Resources.

Therefore, AMC considers the total value for the Mineral Resources at Wafi-Golpu outside both the AMC production cases is zero as presented in Table 9.11.

Table 9.11 Valuation of Mineral Resources outside Wafi-Golpu AMC production cases

Case	Measured Resource (koz AuEq)	Indicated Resource (koz AuEq)	Inferred Resource (koz AuEq)	Low (A\$M)	Preferred (A\$M)	High (A\$M)
Outside AMC Production Case 1	-	23,406	6,114	0	0	0
Outside AMC Production Case 2	-	23,406	6,114	0	0	0

9.3 Exploration Assets without Mineral Resources

Mineral tenements without Mineral Resources have been valued using ranges of value per unit area (km²) derived from comparable transactions in a subscription database. AMC typically considers comparable transactions within the last five years. Due to the large number of transactions available, AMC has used four years for this valuation to give greater emphasis to more recent years.

Transactions in Australia and PNG have been considered based on the available data and the similarities seen between the Australian and PNG transactions of projects with Mineral Resources described above. While there is only one transaction in PNG, AMC considers this to be comparable, and therefore has assumed that tenement transactions will also be similar in both countries and Fiji. There will be differences from site to site within each country and between countries due to differences in influencing factors such as geology, prospectivity, and available infrastructure.

There is limited data about Newcrest exploration activities for some tenements and information on defined exploration targets. As such, AMC has considered each region as a tenement package, rather than attempting to determine a combined valuation for individual tenements. AMC considers this will give a very similar total result, and any differences will not be material to the overall valuation result for this ITSR.

A number of recent transactions of tenements without Mineral Resources have been considered to determine values per unit area for exploration tenement packages that are prospective for gold and copper deposits based on gold as the primary search criteria. These are listed in Table 9.12. AMC considers that the historical transactions are still relevant to the valuation date and do not require adjustment.

Newcrest - Independent Technical Specialist's Report

Grant Samuel & Associates Pty Ltd

0223041

Table 9.12 Transactions for tenements in Australia and PNG without Mineral Resources

Date	Project	Buyer Comparable transactions	Area (km ²)	Value (A\$M)	Implied Value (A\$/km ²)
19/04/2019	Kuta Ridge, PNG	Orefinders Resources Inc.	89	2.50	14,044
14/03/2019	Yandal	Carnegie Exploration Pty Ltd	111	0.55	4,955
4/04/2019	Yampi	Dreadnought Resources Limited	907	1.12	1,235
5/04/2019	Leonora	Blaze International Limited	24	0.15	6,523
10/04/2019	Green Dam	St Barbara Limited	210	0.70	3,333
15/04/2019	Hobbes project	OreCorp Limited	95	0.00	36,842
19/04/2019	Kuta Ridge, PNG	Orefinders Resources Limited	89	2.50	14,044
23/05/2019	Mt Venn	Cazaly Resources Limited	390	1.50	3,833
27/06/2019	Illaara	Dreadnought Resources Limited	726	0.12	165
5/08/2019	Various	Aurenne Group Holdings Pty Ltd	180	2.50	13,875
20/09/2019	Cashman Project	Sandfire Resources NL	248	1.97	7,960
11/10/2019	Belgravia Project	Krakatoa Resources Ltd	96	0.71	7,419
31/10/2019	Jericho, Bunjarra Well	OreCorp Limited	86	0.13	1,456
18/11/2019	E45/5572	Avira Resources Limited	135	0.25	1,852
18/11/2019	Ironstone Well	Golden Mile Resources Ltd	1	0.02	23,529
18/12/2019	West Musgrave	Cassini Resources Limited	1,946	0.25	128
20/12/2019	Cardinia	Kin Mining NL	3	0.03	11,765
15/01/2020	E20/948	Scorpion Minerals Limited	384	0.25	651
31/01/2020	6 exploration licences	Kincora Copper Limited	580	1.95	3,364
11/06/2020	Two EPMs	Rio Tinto Exploration	178	0.05	280
26/06/2020	New Norcia	Lachlan Star Limited	600	0.61	1,022
9/07/2020	Hampton Victory	Black Cat Syndicate Limited	257	0.20	778
27/10/2020	EL5586	Rio Tinto Exploration	300	0.25	833
23/11/2020	Alford East Project	Thor Mining PLC	346	1.47	4,250
24/11/2020	E80/4990	Peako Limited	224	0.38	1,713
15/12/2020	Highlands Copper Project	Larvotto Resources Ltd	900	0.63	694
16/02/2021	Black Range Project	Resource Base Limited	409	1.52	3,716
18/02/2021	5 exploration licences	Odin Metals Limited	2,600	1.00	385
25/02/2021	2 EPMs	South32 Limited	137	1.00	7,299
24/03/2021	Ravenswood Project	Sunshine Gold Limited	373	0.41	1,111
15/06/2021	Trilby and Lorne properties	RooGold Inc.	229	0.00	5,240
22/06/2021	Russell Copper Project	Battery Minerals Limited	258	2.60	10,077
23/06/2021	Flanagans Copper-Gold	Bindi Metals Limited	188	0.45	2,394
17/11/2021	M29/417 and M29/418	Zuleika Gold Limited	17	0.01	588
16/12/2021	Commando project	Pursuit Minerals Limited	30	0.40	13,333
22/12/2021	E39/2040	Legacy Iron Ore Limited	12	0.10	8,333
11/01/2022	E37/1287 & E37/1355 tenements	Ozz Resources Limited	63	0.15	2,317
12/01/2022	Bright Property	A.I.S. Resources Limited	57	1.25	21,930
27/01/2022	Titan Project	Queensland Gold Hills Corp.	90	0.10	1,111
3/02/2022	Niagara project	Regener8 Resources NL	10	1.45	145,000
21/02/2022	E 29/1095	Javelin Minerals Limited	72	0.05	694
7/03/2022	Exploration license E38/3434	Brightstar Resources Limited	12	0.01	833
30/05/2022	Mumbakine Well Project	Capricorn Metals Ltd	361	5.00	13,850
4/07/2022	Mt Piper Gold project	Kalamazoo Resources Limited	1,609	0.30	186
28/07/2022	Additional tenure	IRIS Metals Limited	4	0.06	15,038

Annexure 1. Independent Expert's Report

Newcrest - Independent Technical Specialist's Report

Grant Samuel & Associates Pty Ltd

0223041

Date	Project	Buyer Comparable transactions	Area (km ²)	Value (A\$M)	Implied Value (A\$/km ²)
23/08/2022	Anketell Project	Wishbone Gold Plc	10	0.60	60,000
30/08/2022	EL 8807 and EL 6378 tenements	Cosmos Exploration Limited	65	0.14	2,115
28/09/2022	Gold and Mineral Rights E51/1681	E79 Gold Mines Limited	120	0.15	1,250
2/12/2022	Smokebush Gold Project	Terrain Minerals Limited	13	0.45	35,885
6/12/2022	E51/1995 Mine	Great Boulder Resources Limited	61	0.01	164
2/03/2023	Mainland Area	Musgrave Minerals Limited	8	0.53	63,321

Note: Transaction values stated are for the percent of the tenement ownership transacted. The value for 100% of the property is implied from the transaction to determine the implied value per square km.

The implied values per square kilometre are compared with the area of the tenements subject to the transaction in Figure 9.5. Outliers have been removed. There is a general relationship between tenement area and the unit area value indicated by transactions. Smaller tenement holdings can have a high implied value per square kilometre, and larger tenement holdings have a lower implied value per square kilometre.

Figure 9.5 Comparison of unit area value and tenement area – Australia and PNG

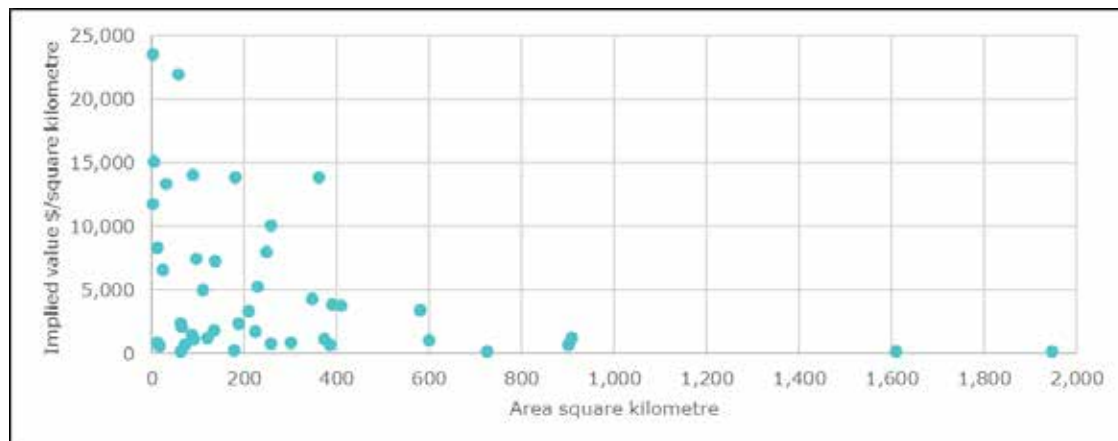

Source: AMC analysis of public information

The unit area values indicated by transactions in Australia are clustered into three groups:

- A\$200 to A\$3,500 per km², particularly above 400 km² in area.
- A\$3,500 to A\$8,000 per km².
- A\$8,000 to A\$15,000 per km².

Above A\$15,000 per km², most areas are less than 10 km².

AMC assessed comparable transactions of tenements in Canada in 2023 to determine whether these are comparable with transactions in Australia. These transactions are summarized in Table 9.13. AMC used an exchange rate of CAD\$1 to A\$1.1 for each transaction.



Newcrest - Independent Technical Specialist's Report

Grant Samuel & Associates Pty Ltd

0223041

Table 9.13 Transactions for tenements in Canada in 2023 without Mineral Resources

Date	Project	Buyer Comparable transactions	Area (km ²)	Value (A\$K)	Implied Value (A\$/km ²)
1/03/2023	50 Claims	EGR Exploration Ltd./50 Claims	0.4	2.70	6,700
8/03/2023	20 Claims	ESGold Corp./20 claims	23.6	6.60	280
8/02/2023	Dog Lake	Fulcrum Metals plc/Dog Lake Prop.	89.0	2.31	26
3/03/2023	Rainbow	Golden Cariboo	1.0	38.5	36,842
3/03/2023	RM1	Golden Cariboo	0.2	8.25	42,526
3/03/2023	Yes	Golden Cariboo	0.6	6.6	11,340
3/03/2023	Rimrock	Golden Cariboo	1.2	66.0	56,750
26/04/2023	El Medio	Heartfield	24.2	66.0	2,725
23/02/2023	Cathro	SKRR Exploration	32.8	44.0	1,343
19/01/2023	14 claims	TRU Precious Metals	35.0	297.0	8,486
21/04/2023	Turgeon Lake	Xcite Resources	20.7	27.7	1,340

In general, many of the claim sizes transacted in Canada are smaller than in Australia, and both countries have high unit area values for small areas. For larger tenement holdings in Canada the unit area value is similar to Australia with transactions below A\$15,000.

Figure 9.6 Comparison of unit urea value and tenement area – Canada

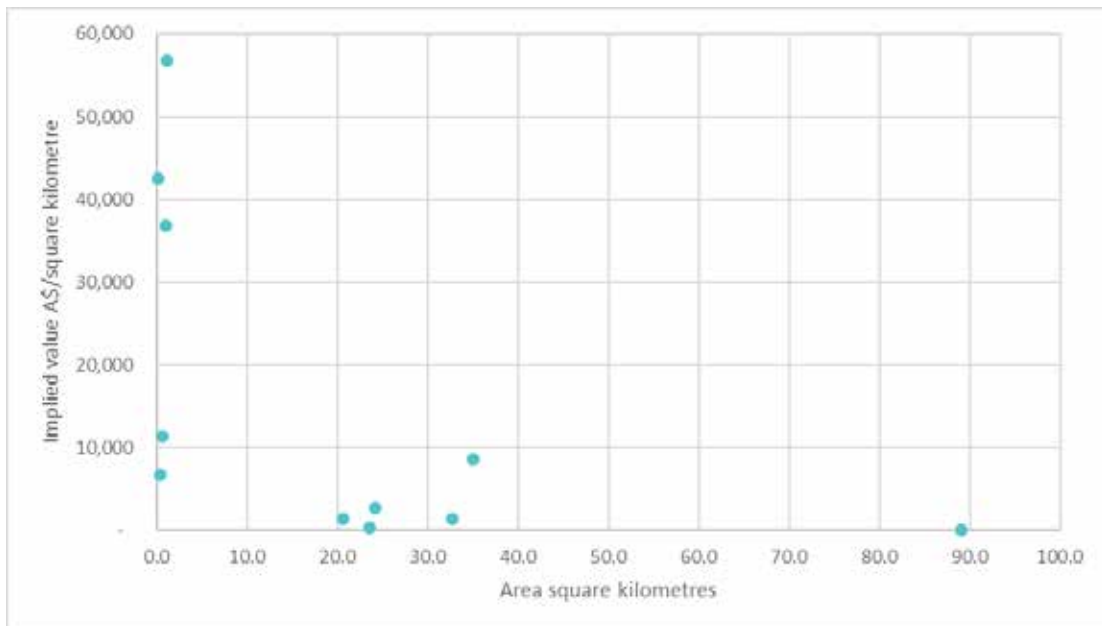

As Canada transactions are similar to Australia below A\$15,000/km², AMC has applied the same ranges for Canada and Australia.

To distinguish tenement packages that might be more prospective than others, Newcrest's tenements have been grouped to reflect available data, geological understanding and recognised prospectivity. Within the lower cluster, less than A\$3,500 per km², tenement packages have had limited exploration, have no established exploration potential or are large. Tenements with early-stage exploration activity indicating further potential are at the higher end of this range.

The middle cluster is considered to show a moderate or high level of prospectivity from exploration activities and geological understanding, correlation with known mineralization styles,

Newcrest - Independent Technical Specialist's Report

Grant Samuel & Associates Pty Ltd

0223041

or assay results. These may also include targets adjacent to identified Mineral Resources, and larger tenement packages with several projects considered prospective or exploration data suggesting high prospectivity. Those tenement packages are the focus of further exploration and resource definition activity.

The third cluster is considered by AMC to be highly prospectivity within small exploration tenement packages:

- The exploration tenement packages cover wide areas with reasonable prospectivity. The tenements have been valued by applying the following unit area values to the tenement areas:
 - Tenement packages of small area, and very high prospectivity: A\$10,000 to A\$15,000 per km².
 - Tenement packages with identified targets, proximity to known deposits, mineralized grade intercepts and supporting geology: A\$8,000 to A\$10,000 per km².
 - Tenements with identified anomalies, prospective exploration targets, supporting geology, proximity to known deposits and some supporting data: A\$3,500 to A\$8,000 per km².
 - Tenements with identified anomalies or prospective exploration targets and supporting geology: A\$1,500 to A\$3,500 per km².
 - Other tenements: A\$200 to A\$1,500 per km².

AMC does not attribute additional exploration value to a tenement that hosts an Ore Reserve included in an AMC production case or a Mineral Resource valued using the Yardstick Value method, except where the Ore Reserve or Mineral Resource is hosted by a very large tenement. The overall value of the tenement is generally considered by AMC to be reflected in the production case or valuation of the Mineral Resource.

AMC has provided valuations for 100% of the tenements. AMC has not considered the percentage of holding by Newcrest or other ownership arrangements as AMC is not appropriately qualified to determine this.

Cadia

Newcrest holds 4 granted exploration licences covering an area of 145.6 km² in the area surrounding Cadia (Figure 9.7). There is an exploration prospecting licence for a further 16.8 km². There are also three pending exploration licences covering 5.69 km² to which 50% of a full valuation has been implied to account for the risk of not being granted. Junction Reefs is discussed later.

The exploration target is similar deposits to the Cadia deposits already identified. Previous exploration activities focused on improving the understanding of the Cadia deposits. Other targets with limited apparent exploration include Warrengong, Black Rock, and Gooleys.

Newcrest considers Cadia to be a future growth option and is opportunistically searching. AMC considers this to mean that there are no clear exploration targets.

AMC considers the tenements to have some prospectivity for the target mineralization style in a region of known deposits. Exploration activity is ongoing. AMC considers that a unit area value A\$3,500 to A\$8,000 per km² is appropriate indicating a valuation of the Cadia Exploration Assets at between A\$0.7M and A\$1.5M with a preferred value of A\$1.1M.

Newcrest - Independent Technical Specialist's Report

Grant Samuel & Associates Pty Ltd

0223041

Figure 9.7 Cadia and Junction Reefs tenements

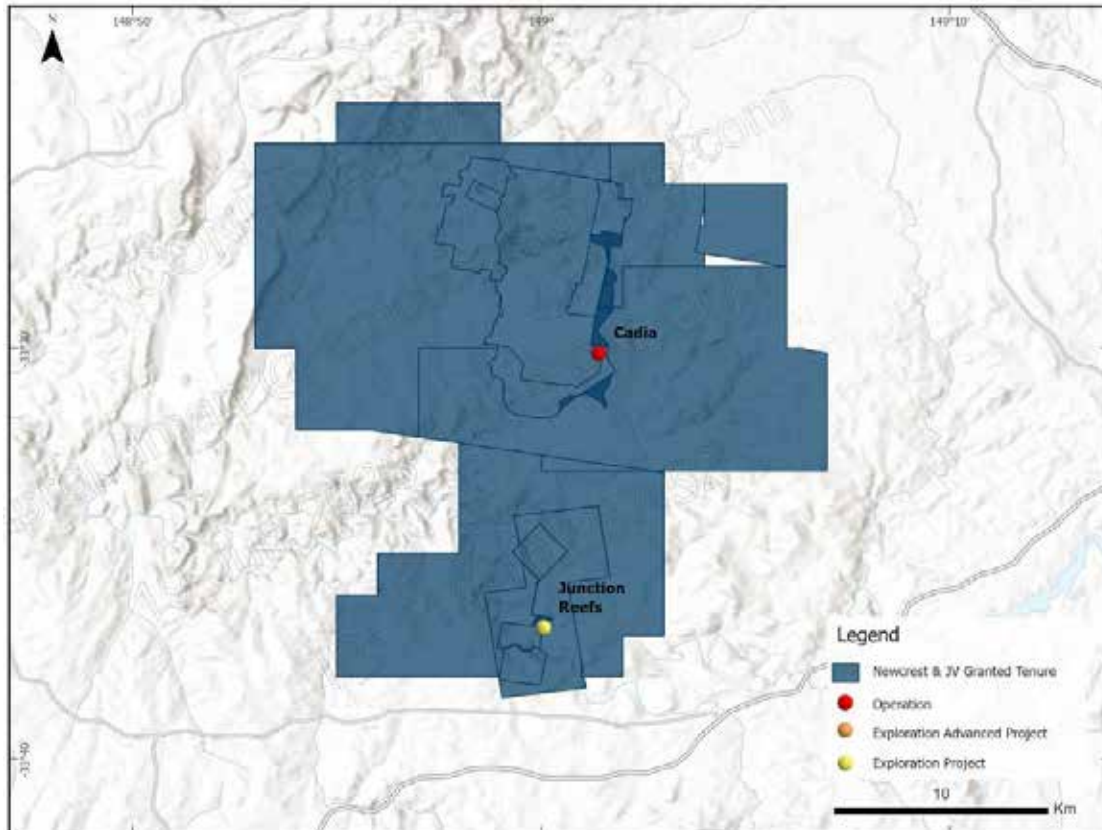

Lihir

Newcrest holds a single EL at Lihir (Figure 9.8). The remaining tenements held relate to the mining operations. The EL is 210 km². However, there is limited focus beyond the known resources due to the scale of the pit. Access to the tenement is also considered a limitation.

AMC considers the tenements to be prospective for the target mineralization style in a region of known deposits. Exploration activity beyond current mining is at a grass roots stage. AMC considers that a unit area value A\$1,500 to A\$3,500 per km² is appropriate indicating a valuation of the Lihir EL at between A\$0.3M and A\$0.75M with a preferred value of A\$0.5M.

Newcrest - Independent Technical Specialist's Report

Grant Samuel & Associates Pty Ltd

0223041

Figure 9.8 Lihir tenement



Telfer Paterson Region

Newcrest holds 12 granted exploration licences around the Telfer MLs covering an area of 372.4 km² (Figure 9.9). There are four miscellaneous licences (LL) at Havieron covering 9.34 km². These are access corridors. The MLs at Havieron and O'Callaghan host Mineral Resources. These MLs are 265.6 km² and 10 km² respectively.

Newcrest - Independent Technical Specialist's Report

Grant Samuel & Associates Pty Ltd

0223041

Figure 9.9 Telfer and Paterson region tenements

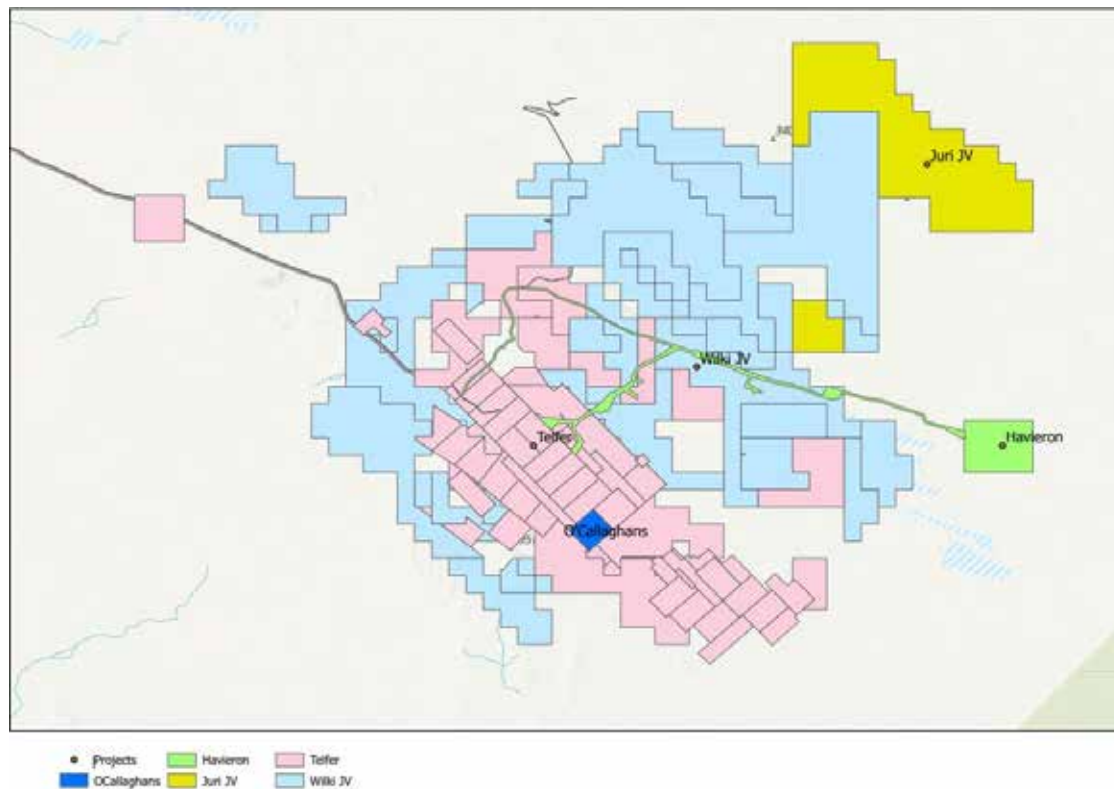

Newcrest has a strategic foothold in the prospective, under-explored Paterson province and ownership of the only large-scale facility in the region. Recent discoveries demonstrate the region is prospective for gold and copper mineralisation. There is a significant regional exploration programme underway. This includes the early entry into the Wilki project partnership with Antipa Minerals and the Juri joint venture with Greatland.

Drilling at Havieron continues to show high-grade mineralisation extends beyond the current resources. These include the Northern Breccia and Pods and the Eastern Breccia. In addition, there is potential for Havieron-like prospects within the larger tenement holding.

AMC considers the tenements to have prospectivity for the target mineralization style in the region. Exploration activity is ongoing, and joint ventures are in play. AMC considers that a unit area value of A\$3,500 to A\$8000 per km² is appropriate indicating a valuation of Newcrest's Telfer Exploration Assets at between A\$1.3M and A\$3.0M with a preferred value of A\$2.1M.

Newcrest has a joint venture over the Wilki tenements covering 1,324.4 km², Newcrest has satisfied its initial A\$6M expenditure requirement. Under the agreement, Newcrest can earn up to 51% interest in the first stage but has not yet met the requirements for this interest. The tenements are proximal to several projects including Telfer and Havieron. AMC used the Joint Venture Terms method to indicate a valuation of the Wilki tenements at between A\$6.1M and A\$8.0M with a preferred value of A\$7.0M.

These tenements have identified anomalies, prospective exploration targets and supporting geology. As such, as a second method, AMC has applied a range of A\$3,500 to A\$8,000 per km². By this method, an implied range of values for the Wilki tenements is between A\$4.6M and A\$10.6M with a preferred value of A\$7.6M. As this is a broad range and encompasses the Joint

Newcrest - Independent Technical Specialist's Report

Grant Samuel & Associates Pty Ltd

0223041

Venture Terms method implied value, AMC has applied the Joint Venture Terms method to determine the implied valuation.

In 2020, Newcrest entered into the farm-in Juri joint venture with Greatland. As such, Newcrest now holds 51% of the Paterson Range East and Black Hill EL that cover 218.4 km². These tenements have identified anomalies, prospective exploration targets and supporting geology. Therefore, AMC has applied a range of A\$1,500 to A\$3,500 per km². Therefore, an implied range of values for the Juri joint venture is between A\$0.33M and A\$0.76M with a preferred value of A\$0.55M.

Junction Reefs joint venture is an exploration project located approximately 10 km south of Cadia comprising exploration licences covering 289.87 km² with a further 266 km² under application. AMC considers that a unit area value of A\$1,500 to A\$3,500 per km² is appropriate. AMC has applied a 50% discount to the tenements under application as consideration of the potential they are not granted.

AMC considers that the Unit Area method indicates a valuation of 100% of the Junction Reefs tenements at between A\$0.6M and A\$1.5M with a preferred value of A\$1.1. The breakdown by project is provided in Table 9.14

O'Callaghans comprises a single ML with an area of 10 km². O'Callaghans has a reported Mineral Resource. As such, O'Callaghans has been valued using the Yardstick Value method based on the metal content as discussed earlier. There is no additional value attributable using the Unit Area method.

Red Chris

Newcrest has a 70% interest in 204 granted mineral claims covering an area of 718.75 km² of the Red Chris tenement holding (Figure 9.10). AMC considers the tenements to be between grass roots exploration in a region of possibly prospective geology through to those with identified targets, proximity to known deposits, mineralized grade intercepts and supporting geology: As such, AMC considers that an overall unit area value A\$3,500 to A\$8,000 per km² is appropriate indicating a valuation of the Red Chris tenements at between A\$2.5M and A\$5.8M with a preferred value of A\$4.1M.

Newcrest - Independent Technical Specialist's Report

Grant Samuel & Associates Pty Ltd

0223041

Figure 9.10 Red Chris mineral claim tenement area

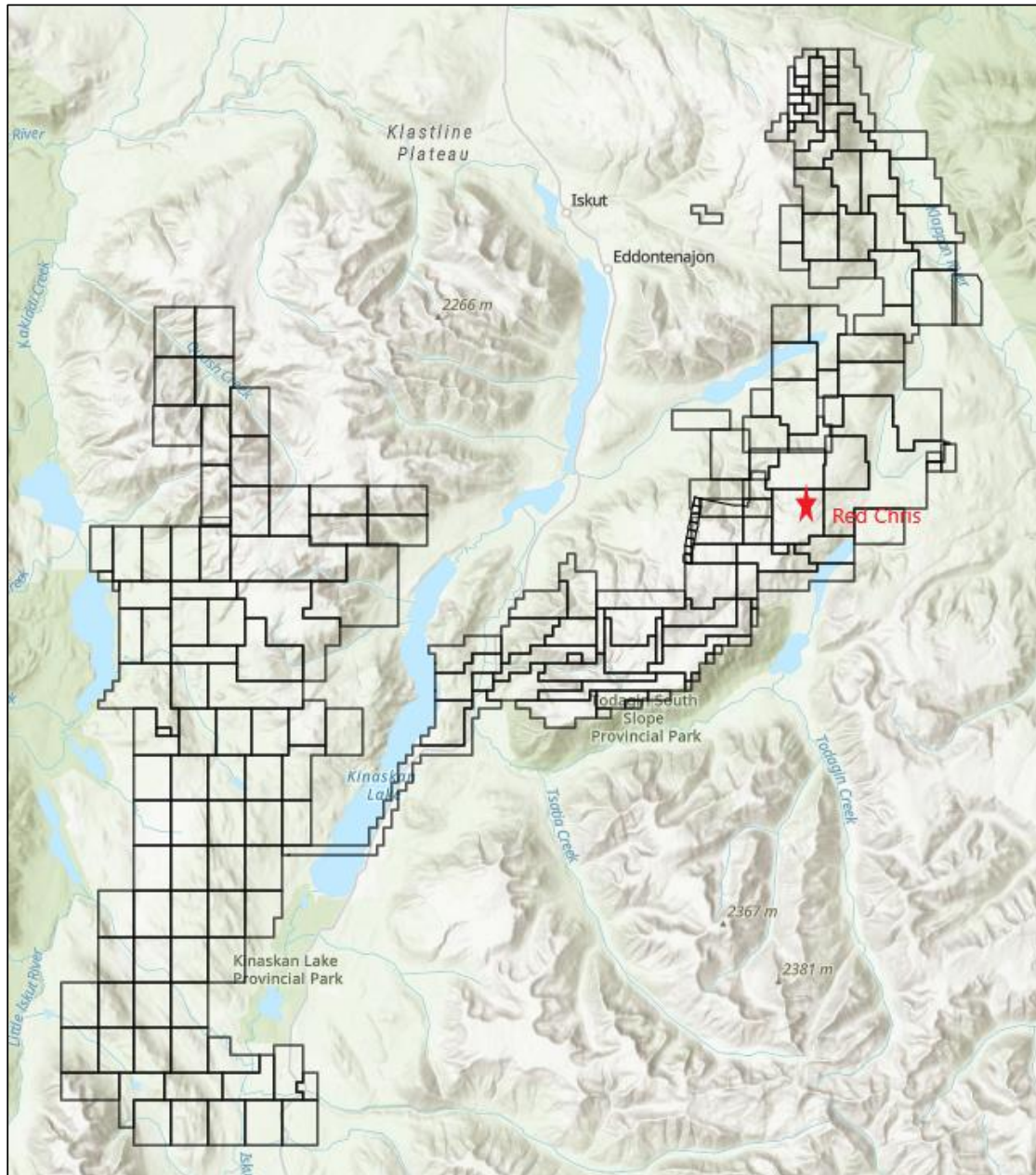

Brucejack

Newcrest holds 346 granted mineral claims covering an area of 1,241.17 km² in the Brucejack tenement area (Figure 9.11). AMC considers the tenements to be of a grass roots nature in an area of possibly prospective geology, with a value range of A\$1,500 to A\$3,500 per km² through to a number with identified targets, proximity to know deposits, highly prospective with mineralized grade intercepts and supporting geology, with a value range of A\$8,000 to A\$10,000 per km².

Newcrest - Independent Technical Specialist's Report

Grant Samuel & Associates Pty Ltd

0223041

AMC notes that the tenement package is large, and the highly prospective tenements will form a small area. As such, AMC considers that a broader unit area value of A\$3,500 to A\$10,000 per km² is appropriate for the entire tenement package, indicating a valuation of the Brucejack tenements at between A\$4.3M and A\$12.4M with a preferred value of A\$8.4M.

Figure 9.11 Brucejack mineral claim tenement area

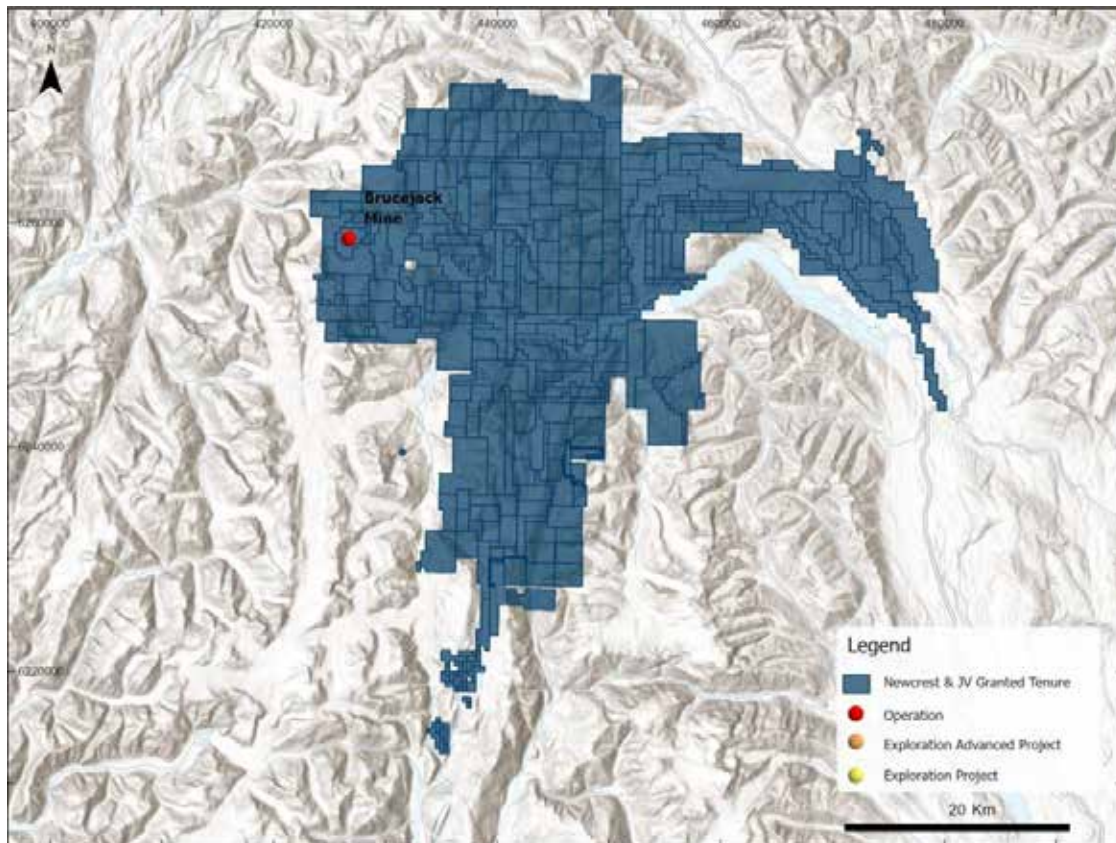

Wafi-Golpu

Newcrest holds a 50% stake in the WGJV with Harmony Gold (Figure 9.12). There are currently two granted exploration licences. The two exploration licences total 129 km² in area. Eight mining leases and seven mining easements within the WGJV are under application. However, as the mining lease tenements reflect the locations of the AMC production Cases for the purpose of the valuation, these areas have been omitted from the WGJV tenements to determine the valuation of the Exploration Assets. On this basis the area of the exploration tenements within the WGJV is reduced by 43 km² to 80 km². No value is attributed to the mining easements.

There are another three tenements at Wamum with an area of 142.2 km² that are 100% owned by Newcrest. The mining related tenements that fall within Wamum are generally easements or access related and are not considered material to the valuation.

Newcrest - Independent Technical Specialist's Report

Grant Samuel & Associates Pty Ltd

0223041

Figure 9.12 Wafi-Golpu tenements

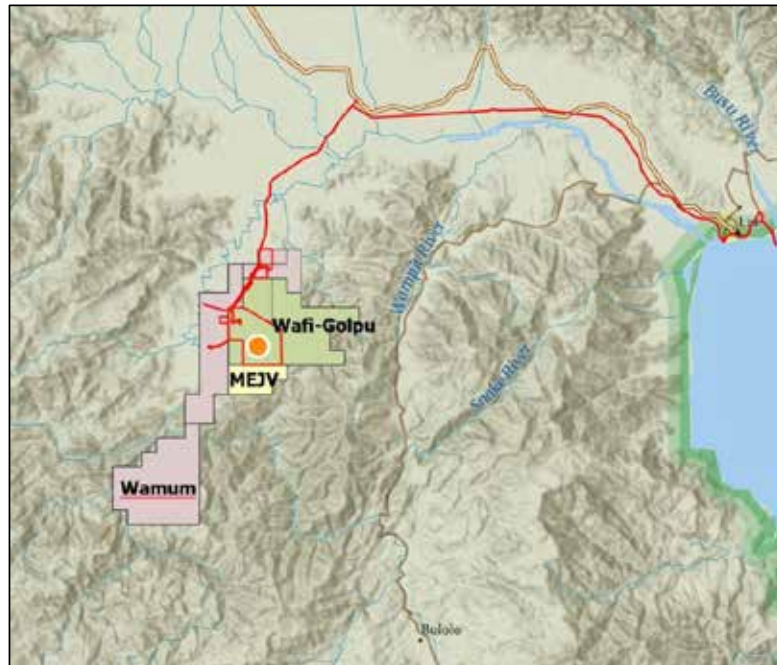

AMC considers the WGJV tenements to be prospective and proximal to known deposits. AMC considers that a unit area value A\$3,500 to A\$8,000 per km² is appropriate indicating a valuation of 100% of the WGJV Exploration Assets at between A\$0.28M and A\$0.64M with a preferred value of A\$0.46M.

AMC considers the Wamum tenements to be of a grass roots nature in an area of possibly prospective geology. However, AMC also recognises the proximity to WGJV. Therefore, AMC considers that a unit area value A\$1,500 to A\$3,500 per km² is appropriate indicating a valuation of the Wamum Exploration Assets at between A\$0.21M and A\$0.50M with a preferred value of A\$0.35M.

Namosi

The Waisoi and Wainaulo deposits are located within a single Special Prospecting Licence that covers 469 km² on the Fiji island of Viti Levu. There is only one tenement, and it contains Mineral Resources for both Waisoi and Wainaulo. AMC considers all the value of this tenement is reflected in the valuation of Mineral Resources.

Newcrest - Independent Technical Specialist's Report

Grant Samuel & Associates Pty Ltd

0223041

Figure 9.13 Namosi tenement

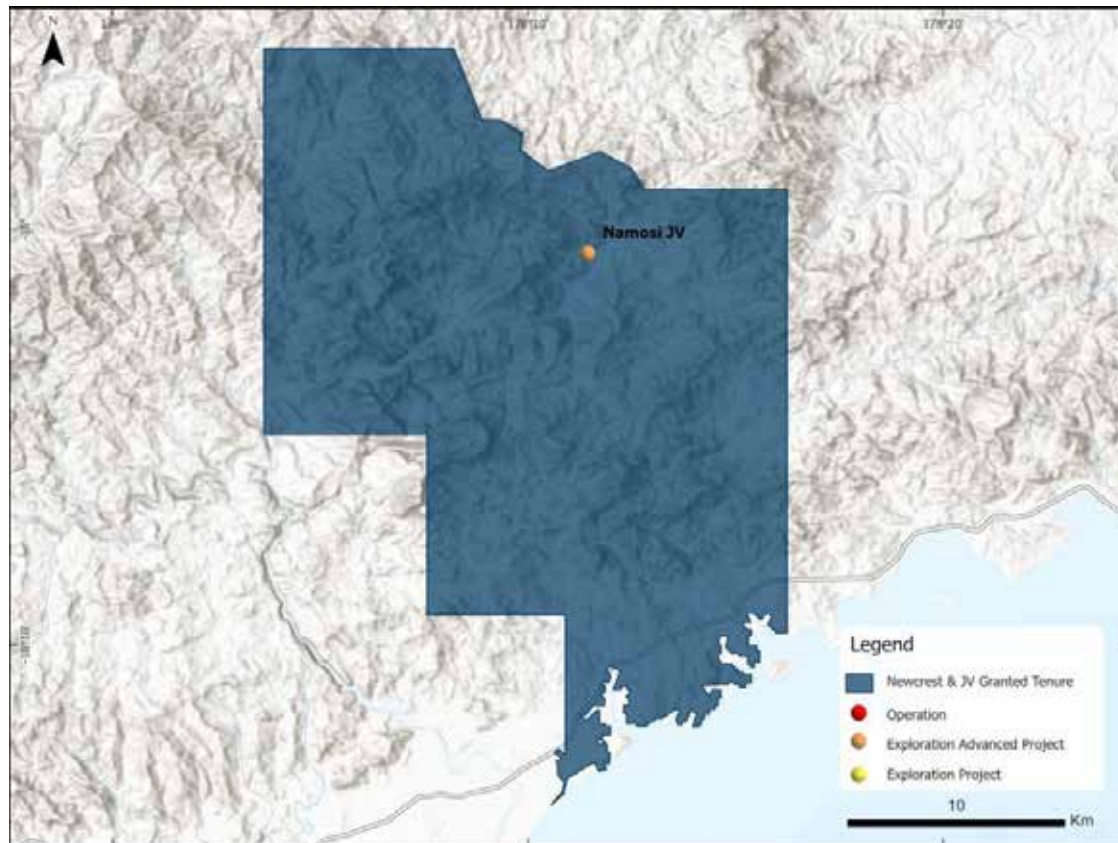

Asia Pacific

Newcrest holds interests in tenements in a number of other locations in Australia that are not associated with the Telfer, or the Paterson joint ventures described above. Namely:

- Mt Coolon in the Drummond Basin, Queensland (2,254.2 km²).
- Tennant East at Tennent Creek, NT (4,104.8 km²).

Tennent East and Mt Coolon are exploration projects, and Newcrest is yet to meet the requirements to earn an interest at Mt Coolon. Information available to AMC suggests there is limited activity on these tenements. Therefore, AMC considers that a unit area value of A\$200 to A\$1,500 per km². This range gives rise to a large valuation range, particularly for the large tenement areas such as at Tennent Creek. This is due to the low end of the range being very low and an order of magnitude lower than the upper limit.

AMC considers that the Unit Area method indicates a valuation of 100% of the Asia Pacific tenements at between A\$1.3M and A\$9.6M with a preferred value of A\$5.4. The breakdown by project is provided in Table 9.14.

Canada

In addition to Red Chris and Brucejack exploration tenements, Newcrest holds a package of nine tenements totalling 37.4 km² at Boomerang in British Columbia. AMC considers the tenements to be of a grass roots nature in an area of possibly prospective geology. AMC considers that a unit area value A\$200 to A\$1,500 per km² is appropriate indicating a valuation of the Boomerang Exploration Assets at between A\$0.01M and A\$0.06M with a preferred value of A\$0.03M.



Newcrest - Independent Technical Specialist's Report

Grant Samuel & Associates Pty Ltd

0223041

USA

In August 2022, Newcrest entered into four separate definitive option and earn-in agreements with Headwater Gold Inc. (Headwater). In May 2023, Newcrest entered into an additional option and earn-in agreement on Headwater Gold's Lodestar project and exited a similar agreement at the Agate Point project. Newcrest has the option to acquire up to a 75% interest individually in each of the Lodestar, Midas North, and Spring Peak Projects in Nevada and the Mahogany Project in Oregon. The initial payments total US\$0.7M plus an expenditure of US\$10M for each of Lodestar, Mahogany, and Midas North, and US\$15M for Spring Peak which gives Newcrest the option to earn a 51% interest on all four projects, noting that each earn-in is independent and Newcrest can choose which, if any, it proceeds with.

The Spring Peak project is located approximately 35km southwest of Hawthorn, Nevada in the Aurora mining district. In 2022 Headwater completed a total of 3,170m drilled in 10 holes across the project area including both RC pre-collar with diamond tails and three RC only holes. These identified high-grade mineralisation at the Disco zone and the new high-grade Opal Ridge zone. Exploration suggests a low sulfidation epithermal system over an interpreted area of 2.5km x 1.5km.

Lodestar located in Nevada is approximately three kilometres north of Spring Peak in the Aurora Mining district. A limited number of drillholes completed in the 1980s identified some anomalous gold grades.

Mahogany is located in southeastern Oregon, 20 km from the DeLamar deposit. Headwater drilled five diamond drillholes, with geology interpreted to be a possible feeder to epithermal alteration, with anomalous gold grades.

Midas North adjoins the past producing Midas Mine. Rock chips and stream sediments support the presence of epithermal alteration. There is limited exploration and no known drilling.

AMC used the Joint Venture Terms method for the four Headwater joint venture projects together to indicate a valuation for 100% of these USA tenements at between A\$31M and A\$49M with a preferred value of A\$40M. However, AMC understands that Newcrest has not yet fulfilled the first stage of earn-in, and therefore the value to Newcrest is zero.

In September 2022, Newcrest entered into an option and earn-in agreement with Gunpoint Exploration Ltd (Gunpoint). Newcrest has the option to acquire up to a 75% interest in the Appaloosa property in Nevada. The minimum expenditure to enter the Option phase is US\$2M plus a payment of US\$1M. A further expenditure of US\$10M plus US\$1.5M payment gives Newcrest the option to earn a 51% interest.

AMC used the joint venture terms method for the Appaloosa project to indicate a valuation for the Appaloosa tenements at between A\$16M and A\$19M with a preferred value of A\$18M. However, AMC understands that Newcrest has not yet fulfilled the first stage of earn-in, and therefore the value to Newcrest is zero.

Summary of Unit Area and Joint Venture Terms methods valuations

Table 9.14 provides a summary of the valuations of the Exploration Assets (based on 100%) by the Unit Area method or the Joint Venture Terms method in A\$ and US\$. The valuations are for 100% ownership of the tenement areas. The total valuation for Newcrest's equity is also provided. AMC has converted the valuations to US\$ using an exchange rate of US\$0.68/A\$1.00.

Annexure 1. Independent Expert's Report

Newcrest - Independent Technical Specialist's Report

Grant Samuel & Associates Pty Ltd

0223041

Table 9.14 Summary of valuation of Exploration Assets (based on 100%)

Asset	Area (km ²)	Low (A\$M)	Preferred (A\$M)	High (A\$M)	Low (US\$M)	Preferred (US\$M)	High (US\$M)	Equity (%)
Cadia	219	0.7	1.1	1.5	0.5	0.7	1.0	100
Telfer	372	1.3	2.1	3.0	0.9	1.4	2.0	100
Juri JV*	218	0.3	0.6	0.8	0.2	0.4	0.5	51
Wilki	1,324	6.1	7.0	8.0	4.1	4.8	5.4	0
Red Chris	719	2.5	4.1	5.8	1.7	2.8	3.9	70
Brucejack	1,241	4.3	8.3	12.3	2.9	5.6	8.4	100
Lihir	210	0.3	0.6	0.8	0.2	0.3	0.5	100
Wafi-Golpu – WGJV	80	0.3	0.5	0.6	0.2	0.3	0.4	50
Wafi-Golpu - Wamum	142	0.2	0.4	0.5	0.1	0.2	0.3	100
Namosi	-	-	-	-	-	-	-	73.03
Havieron	-	-	-	-	-	-	-	70
Junction Reefs#	556	0.6	1.1	1.5	0.4	0.7	1.0	80.57
Mt Coolon	2,254	0.5	1.9	3.4	0.3	1.3	2.3	0
Tennant East	4,105	0.8	3.5	6.2	0.6	2.4	4.2	100
Boomerang Canada	37	0.0	0.0	0.1	0.0	0.0	0.0	100
Headwater USA*	-	30.9	39.7	48.5	21.0	27.0	33.0	0
Appaloosa Gunpoint USA*	-	16.2	17.6	19.1	11.0	12.0	13.0	0
Total (100%)		65	89	112	44	60	76	-
Total Newcrest equity		10	20	30	7	14	21	-

Note: * subject to Joint Venture; #portion under application valued at 50%; areas rounded

These methods indicate a valuation of the Exploration Assets (based on 100%) from A\$65M to A\$112M with a preferred value of A\$89M. For Newcrest's equity, based on the percentages provided in Table 9.14 the valuation is from A\$10M to A\$30M with a preferred value of A\$20M.

9.4 Summary valuation – Mineral Resources outside the AMC production cases and Exploration Assets

The summary of AMC's valuation for Newcrest's Mineral Resources outside the AMC production cases, and valuations of the Exploration Assets is presented in Table 9.15.

Newcrest - Independent Technical Specialist's Report

Grant Samuel & Associates Pty Ltd

0223041

Table 9.15 Summary valuation of Mineral Resources outside AMC production cases and Exploration Assets

Mineral Asset		Low (A\$M)	Preferred (A\$M)	High (A\$M)	Low (US\$M)	Preferred (US\$M)	High (US\$M)
Mineral Resources (based on 100%)							
Outside AMC Production Case 1	Cadia*	391	590	859	266	401	584
	Telfer	43	77	111	29	52	75
	Havieron	35	78	122	24	53	83
	O'Callaghans	40	61	82	27	41	56
	Lihir	202	325	448	137	221	305
	Red Chris	71	229	480	48	156	326
	Brucejack	97	182	267	66	124	182
	Namosi	48	167	286	33	114	194
	Wafi-Golpu	-	-	-	-	-	-
Total		927	1,709	2,655	630	1,162	1,805
Outside AMC Production Case 2	Cadia*	540	772	1,084	367	525	737
	Telfer	23	46	70	16	31	48
	Havieron	2	25	47	1	17	32
	O'Callaghans	40	61	82	27	41	56
	Lihir	202	325	448	137	221	305
	Red Chris	26	92	205	18	63	139
	Brucejack	27	77	128	18	52	87
	Namosi	48	167	286	33	114	194
	Wafi-Golpu	-	-	-	-	-	-
Total		908	1,565	2,350	617	1,064	1,598
Exploration Assets (based on 100%)							
Total		65	89	112	44	60	76
Exploration Assets (based on Newcrest equity)							
Total		10	20	30	7	14	21

Note: *DCF value based on AMC schedules

Annexure 1. Independent Expert's Report

Newcrest - Independent Technical Specialist's Report

Grant Samuel & Associates Pty Ltd

0223041

Appendix A Contributors to the ITR

Name	Qualifications	Affiliations	Involvements
David Varcoe	BEng (Mining)	AMC Principal Mining Engineer; FAusIMM	Project Manager and author
Lawrie Gillett	BEng (Mining) DipGeosc (Mineral Economics)	AMC Principal Mining Engineer; FAusIMM	Peer review
Benjamin Morin	BSc (Mining Engineering) MSc (Geotechnical Engineering)	AMC Principal Mining Engineer; EGBC PEng	Author - Brucejack mining; Red Chris open pit mining
Andrew Proudman	MEngSc (Mining Geomechanics) GradDipAppSc (App Geol) BAppSc (App Geol)	AMC Principal Geologist; FAusIMM CP(Geo)	Author - Cadia geology; exploration and Mineral Resource valuations
Mike Pietrobon	BSc (Mineral Processing)	MinProcesSer Pty. Ltd. Managing Director & Principal Metallurgist; MAusIMM	Author - Cadia, Telfer-Havieron, Red Chris - mineral processing, site infrastructure and services
Mark Burnett	BSc (Hons) Geology MSc (Mineral resource Management)	AMC Principal Geologist; Chartered Geologist (CGeol) European Geologist (EuroGeol)	Author - Red Chris and Brucejack geology
Simon Kusabs	BEng (Mining)	AMC Principal Mining Engineer; FAusIMM	Author - Telfer-Havieron, Wafi-Golpu mining, costs, and production cases
Dean Carville	BSc (Hons) Geology	AMC Principal Geologist; MAusIMM	Author - Namosi and Wafi-Golpu geology. Exploration and Mineral Resource valuations peer review.
Rod Carlson	BSc Geology, MSc (Ore Deposit Geology and Evaluation)	AMC Principal Geologist; MAusIMM, FAIG (RPGeo)	Author - Lihir geology
David Lee	Bachelor of Engineering (Mining) (Hons) Grad Diploma of Business	AMC underground manager Principal mining engineer FAusIMM	Author - Telfer-Havieron, Wafi-Golpu mining, costs, and production cases
Paul Greenhill	BSc (Hons) Doctor of Philosophy (Chemistry)	AMC Principal Consultant FAusIMM	Author- processing
Karl van Olden	MBA, BSc Mining Engineering, GradD Engineering (Mineral Economics), Mine Manager's Certificate of Competency (UG Metalliferous)	AMC Executive Lead, FAusIMM	Author Cadia
Martin Liu	Bachelor of Engineering (Mining Engineering)	AMC Senior Mining Engineer MAusIMM	Contributor
Jason Jurg	Bachelor of Engineering (Civil)	AMC Principal Mining Engineer	Contributor
Dominic Claridge	Bachelor of Engineering (Mining),	AMC Principal Mining Engineer FAusIMM	Author Brucejack and Red Chris
Glen Williamson	BEng (Hons, Mining)	AMC Principal Mining Engineer; FAusIMM; CP (Mining); RPEQ (Mining)	Peer review
Kristy Sell	B. Nat Res (Hons) Grad Dip (Nat Res Law).	Martinick Bosch Sell Pty Ltd Managing Director and Principal Consultant	Author -Brucejack and Red Chris environmental assessment
Matt Todd	BSc (Agric) Hons, Phd, Masters Business Administration	Martinick Bosch Sell Pty Ltd General Manager and Principal Consultant	Author - Telfer environmental assessment
Belinda Bastow	BSc (Hons, Environmental Biology), PostGradDip, MEnvLaw	Integrate Sustainability Pty Ltd Director and Principle EHS Specialist.	Author - Cadia, Lihir, Wafi-Golpu environmental assessment
Rob Chesher	Bachelor of Science (Metallurgy) (Honours)	AMC Technical Manager FAusIMM	Author -processing

Newcrest - Independent Technical Specialist's Report

Grant Samuel & Associates Pty Ltd

0223041

Appendix B References

Reference Name	Document Name	Document Date
General References		
Newcrest 2022 Annual Report	Newcrest Annual Report 2022. Retrieved from Investor Centre - Results and Reports centre: https://www.newcrest.com/sites/default/files/2022-11/221004_Annual%20Report%202022_0.pdf	2022
Newcrest 2022 Sustainability Report	2022 Sustainability Report. Retrieved from Newcrest Mining Limited: https://www.newcrest.com/sites/default/files/2022-11/221107_Newcrest%202022%20Sustainability%20Report_0.pdf	2022
Newcrest 2022 MRE and ORE	Newcrest Annual Mineral Resources and Ore Reserves Statement - as at 30 June 2022 on a 100% basis.	2022
Newcrest 2023 MRE and ORE	Newcrest Annual Mineral Resources and Ore Reserves Statement - as at 30 June 2023 Draft v8 (03.09.01.07)	2023
Newcrest Financial Model	Newcrest Financial Model.xlsx	Unknown
SP Global Commodity Forecast	SPGlobal_CommoditiesEstimates(Consensus)20Jun2023	2023
Metal Prices 2011	Updated Metal Prices and Exchange Rate Resources and Reserves 12 Sept 2011.pdf	2011
Newcrest Management Presentation.pdf	Newcrest Management Presentation.pdf	2023
Newcrest Technical Management Presentation (IER)	Newcrest Technical Management Presentation (IER).pdf	2023

Reference Name	Document Name	Document Date
Tenure references		
Tenure Report WA and NSW	20230714 NCM Due Diligence WA and NSW	2023
Tenure Report PNG	20230727 - AMETS - PNG Tenure (002)	2023
Tenure Report Canada	Newcrest Mining Limited - Executed Title Opinion dated 12 Jul 2023(48271357.1)	2023

Reference Name	Document Name	Document Date
Cadia References		
Cadia 3-yr Actuals	CVO_3y actuals - Feb 23	Mar-23
Cadia Technical Report	NI 43-101 Technical Report on Cadia Operations as of 30 June 2020.pdf	Jul-20
Cadia East Mineral Resource Report	Cadia East Feb 2021 - Mineral Resource L3 Report - Revision D - DRAFT.pdf	Feb-21
Cadia East Mineral Resource Table 1	2022_-_Cadia_East_-_2022_JUNE_-_FINAL_-_L1_-_Mineral_Resources.pdf	Jun-22
Cadia East Mineral Resource Review	2021-13 NML 2021 MR Reviews Cadia East DRAFT.pdf	May-21
Cadia East Extended Mineral Resource Report	CADIA EXTENDED May 2015 L3 Final DRAFT Report.pdf	Dec-15
Cadia East Extended Mineral Resource Table 1	2022_-_Cadia_Extended_UG_-_2022_JUNE_-_FINAL_-_L1_-_Mineral_Resources.pdf	Jun-22

Annexure 1. Independent Expert's Report

Newcrest - Independent Technical Specialist's Report

Grant Samuel & Associates Pty Ltd

0223041

Reference Name	Document Name	Document Date
Cadia References		
Big Cadia Mineral Resource Report	BIG CADIA July 2015 Newcrest L3 Final DRAFT Report.pdf	Jul-15
Big Cadia Mineral Resource Table 1	2022_-_Big_Cadia_-_2022_JUNE_-_FINAL_-_L1_-_Mineral_Resources	Jun-22
Big Cadia Resource and Reserve Assumptions 2021	Resource and Reserve Metal Price Assumptions Aug 2015 - FINAL	Aug-15
Ridgeway Mineral Resource Report	Ridgeway Resource RptJun09 - Level 3.pdf	Jun-09
Ridgeway Mineral Resource Table 1	2022_-_Ridgeway_-_2022_JUNE_-_FINAL_-_L1_-_Mineral_Resources.pdf	Jun-22
Ridgeway Metal Price Assumptions 2015	1508 - Resource and Reserve Metal Price Assumptions Aug 2015 - FINAL.pdf	Aug-15
Cadia Technical Metallurgy	RDFS Volume 4.5 - Technical Metallurgy_Aug 2007	Aug-07
Cadia East PC1-2 Feasibility Study	Volume 6.4 Technical - Metallurgy & Processing_Cadia East PC1-2 FS	Jul-22
Hatch Comminution Modelling & TSF Report	H367489-0000-210-230-0001	May-22
Cadia Molybdenum Processing	Volume 6.4 Technical - Metallurgy and Processing_Cadia Molybdenum Plant FS	Apr-19
Cadia Molybdenum Processing Flowsheet	Cadia - Process Flow for Molybdenum	Jul-22
Independent TSF Report	ITRB Site Visit 1 Report_April 2023 Final	Apr-23
Cadia Water Efficiency Plan	Cadia Water Efficiency Plan	Nov-20
Cadia Water Plan 2019	CVO Water Management Plan v7.0	Nov-19
Cadia Annual Environmental Report	Cadia Valley Operations Annual Environmental Management Report. NSW: Newcrest Mining Limited (Cadia).	
Cadia Mine Closure Plan	Mine Closure Plan Cadia Valley Operations 710-600-EN-PLA-001-A. NSW, Australia: Newcrest Mining Limited.	2019
Cadia Biodiversity Action Plan	Cadia Valley Operations Biodiversity Action Plan (0505964). NSW: Newcrest Mining	2020
Independent Technical Review Board.	Search Results for Reports. Retrieved from Newcrest: www.newcrest.com/sites/default/files/2019-10/190417_Report%20on%20NTSF%20Embankment%20Failure%20at%20Cadia%20for%20Ashurst.pdf	May-23
Cadia Aboriginal Cultural Heritage Management Plan	Newcrest Mining Limited - Cadia, Aboriginal Cultural Heritage Management Plan (710-005-EN-PLA-0007). Retrieved from Newcrest Mining Limited - Cadia: https://media.caapp.com.au/pdf/xhczkw/71697fda-ed52-44c0-828b-973f1bc9229c/Aboriginal%20Cultural%20Heritage%20Management%20Plan.pdf	Jul-22
Cadia Heritage Stewardship	Heritage Stewardship. Retrieved from Newcrest Mining Ltd - Cadia: https://www.cadiavalley.com.au/newcrest/cvo/environmental-management/heritage-stewardship	May-23
Cadia Current Modiciation Applications	Current Modiciation Applications. Retrieved from Newcrest Mining Pty Ltd - Cadia: https://www.cadiavalley.com.au/newcrest/cvo/statutory-approvals/current-modifications	May-23
Cadia Current Environmental Protection Licence	5590 Environmental Protection Licence. NSW: NSW EPA.	
Cadia Environment Protection Licences	Search for Environment Protection licences, applications, notices, audits or pollution studies and reduction programs. Retrieved from NSW EPA: https://apps.epa.nsw.gov.au/prpoeoapp/SearchResult.aspx?SearchTag=notice&searchrange=notice&range=notice	May-23

Newcrest - Independent Technical Specialist's Report

Grant Samuel & Associates Pty Ltd

0223041

Reference Name	Document Name	Document Date
Cadia References		
Cadia Investigations	Newcrest Cadia mine under investigation. Retrieved from NSW EPA: https://www.epa.nsw.gov.au/news/media-releases/2023/epamedia230522-newcrest-cadia-mine-under-investigation	May-23
Cadia NSW Government Gazette	Government Gazette of the State of New South Wale Number 43. Retrieved from New South Wales Gazette Legislation: https://gazette.legislation.nsw.gov.au/so/download.w3p?id=Gazette_2018_2018-43.pdf	Apr-18
Cadia Forward Program	FWP0001112 Cadia Valley Operations Forward Program (Wednesday 5th October 2022 to Saturday 4th October 2023). NSW: Newcrest Limited.	Oct-22
Cadia East Ore Reserves 2022	Cadia East Pre Reserve Report, June 2022	Jun-22
Cadia East Ore Reserves Update 2022	MEMO Cadia East Reserve Update June 2022	Jun-22
Cadia LOM Production Schedule	Cadia East Life of Mine Production Schedule	May-23
Feasibility Study PC2-3	Volume 6.3 Technical – Mining_Cadia East PC2-3 FS	2018
PC2-3 reconciled to FS	PC2-3 and PC1-2_Progress Reconciled to FS	May-23
Capital cpst breakdown	Cadia_Capital_Breakdown	May-23
Cadia Site cost summary	Cadia - Site Cost Summary	May-23
Technical Report on Cadia Operations	Technical Report on Cadia Operations as of 30 June 2020	2020

Reference Name	Document Name	Document Date
Lihir References		
Lihir 3-yr Actuals	LGO_3y actuals - Feb_23.xlsx	
Lihir Technical Report	NI 43-101 Technical Report on Lihir Operations as of 30 June 2020.pdf	Jun-20
Lihir MOPU Project Vol 2	Lihir Gold Limited Environmental Impact Statement - Million Ounce Plant Upgrade Project. Main Report Vol 2	2009
Lihir Mine Closure Planning	Lihir Mine Closure Planning, FY20 Mine Closure Costs	2020
Deep-Sea Mine Tailings Placement in PNG	Final Report - Independent Evaluation of Deep-Sea Mine Tailings Placement (DSTP) in PNG	2010
Lihir Capital detail	Lihir_Capital_Breakdown (1).xlsx	2023
Lihir Mine Plan LOM	MineMax Schedule Output_23.LoPP.2.18.54_LoPP_BC_S449.xlsx	2023
Flow sheet	Front End Recovery Project Flow Sheet.pdf	2023
Flow diagram	Lihir - Process Plant Process Flow Diagrams Mar 2020.pdf	2020
Phase 14A study	Volume 1 - Executive Summary_Lihir 14A FS.pdf	2023
Kapit Sea Barrier study	Volume 1 & 2 - Summary_Kapit Seepage Control CS.pdf	Apr-22
Lihir Recovery uplift study	Various files	Aug-20
Lihir Geothermal management plan	501-1200-GE-PLA-0002_Lihir Geothermal MP.pdf	Jun-20
Lihir Geotechnical management plan	501-1200-GE-PLA-0003_Lihir Slope Control MP.pdf	Sep-20
FY22 Processing Physicals	FY22 LoPP Processing Physicals INPUT Assumptions V2	Jul-22
Lihir Matlab Model Update	2022 Lihir Matlab Model Update revD [LPS.4.1.0]	Nov-22
Lihir Jameson Project	Lihir Jameson Project - FY22 LoPP Updated Valuation	Jan-23

Annexure 1. Independent Expert's Report

Newcrest - Independent Technical Specialist's Report

Grant Samuel & Associates Pty Ltd

0223041

Reference Name	Document Name	Document Date
Wafi-Golpu References		
Wafi Technical Report	NI 43-101 Technical Report on Wafi-Golpu Project as of 30 June 2020.pdf	2020
Golpu Feasibility Study Independent Review - Mining	CIR Section Report - Mining_Rev1.pdf	Feb-18
Wafi-Golpu Feasibility Study Update – Mining	532-8213-FS-REP-30001-6.3_Rev1_Volume 6.3 - Technical - Mining.pdf	May-18
Golpu Ore Reserve Block Model	GolpuRES15_1200_300.dm	Unknown
Golpu Ore Reserve Design	Golpu FSU design solids all.dxf	Feb-18
Golpu Ore Reserves	2022_-_Golpu_UG_-_2022_JUNE_-_FINAL_-_L1_-_Ore_Reserves.pdf	Jun-22
Golpu Investment Case Schedule	Golpu 2018 2 lift Production & Met recovery.dsf	Unknown
Golpu Investment Case Design	Golpu 2017 FS PFS Jan Uplift 2 lift.dcf	Unknown
Golpu Investment Case Capital Costs 2021	Wafi-Golpu - Capital Breakdown.xlsx	Unknown
Golpu Investment Case Operating Costs 2021	Wafi-Golpu - Site Cost Summary.xlsx	Unknown
Golpu Mineral Resource Report	Golpu Feb14 - Mineral Resource Report Level3_Final	2014
Golpu_UG Mineral_Resources	Golpu_UG_-_2022_JUNE_-_FINAL_-_L1_-_Mineral_Resources	2022
Wafi 2019 Mineral Resource	Wafi 2019 Mineral Resource - Mineral Resource Report_Final_small	2019
2022 Wafi Mineral_Resources	2022_-_Wafi_-_2022_JUNE_-_FINAL_-_L1_-_Mineral_Resources	2022
Nambonga 2022 Mineral_Resources	2022_-_Nambonga_-_2022_JUNE_-_FINAL_-_L1_-_Mineral_Resources	2022
Nambonga 2018 Mineral Resource - Mineral Resource Report Level3_v1	Nambonga 2018 Mineral Resource - Mineral Resource Report Level3_v1	2018
Wafi-Golpu Feasibility Study Update – Processing	532-8213-FS-REP-30001-6.4_Rev0 - Volume 6.4 - Technical - Metallurgy and Processing.pdf	Mar-18

Reference Name	Document Name	Document Date
Telfer/Havieron References		
Telfer 3-yr Actuals	TEL_3y actuals - Feb_23.xlsx	Unknown
Telfer Technical Report	NI 43-101 Technical Report on Telfer Operations as of 31 Dec 2013.pdf	2013
Telfer VSC Study	VSC Directional Study Report.pdf	Feb-22
Telfer West Dome Deeps Study	West Dome Deeps Directional Study Report.pdf	Jul-22
Telfer Underground Ore Reserves	2022_-_Telfer_Underground_-_2022_JUNE_-_FINAL_-_L1_-_Ore_Reserves.pdf	Jun-22
Telfer - Process Plant Flowsheet	Telfer - Process Plant Flowsheet	Unknown
Telfer TSF report	201216R_Telfer_TS8_FMEA_Report	Dec-20
Telfer TSF8 Design report	TSF8 Detail Design	Nov-21

Newcrest - Independent Technical Specialist's Report

Grant Samuel & Associates Pty Ltd

0223041

Reference Name	Document Name	Document Date
Telfer/Havieron References		
Telfer Tailings strategy report	Telfer 2022 TSP ISSD 20230331	Mar-23
Telfer Investment Case Capital Costs	TelferHavieron_Capital_Breakdown_BP.xlsx	Unknown
Telfer Investment Case Operating Costs	Telfer+Havieron - Site Cost Summary.xlsx	Unknown
Telfer Investment Case Physicals	Telfer+Havieron_Physicals_BP.xlsx	Unknown
Havieron PFS Study - Mining	Volume 6.3 - Mining_Havieron Project PFS.pdf	Aug-21
Havieron Ore Reserves	2022_-_Havieron_-_2022_JUNE_-_FINAL_-_L1_-_Ore_Reserves.pdf	Jun-22
Havieron Ore Reserve Mine Plan	HAV_Reserve_case_20210726.dsf/duf	Jul-21
Havieron Capital Estimate Update (2022)	Preliminary Draft Capital Estimate for Havieron Project.pdf	2022
Tungsten Historical Price Chart 2023	SPGlobal_PriceChart-Tungsten(Historic)_21June2023	Jun-23
Tungsten Historical Price Chart 2023	SPGlobal_PriceChart-Tungsten(Chart)_22-Jun-2023_Yearly	Jun-23
Investor presentation	Almonty Industries Investor Presentation - May 2023	May-23
Ore Reserve and Inferred Mineral Resource mine plan	HAV_FS-Draft.duf / HAV_FS-Draft_Ind and Inf.dsf	Unknown
Mineral Resource Report, Camp Dome	2022_-_Camp_Dome_-_2022_JUNE_-_FINAL_-_L1_-_Mineral_Resources.pdf	Jun-22
Camp Dome Mineral Resource Estimate	07_TEL_Camp Dome MR Report L3 Sept 2009 FINAL01.pdf	Sep-11
Mineral Resource Havieron December 2021.	Technical Report_Mineral Resources_Havieron_Dec2021_D2R2.pdf	Feb-22
Havieron Mineral Resource review	P2021-13 NML 2022 MR Review Havieron FINAL.pdf	Jul-22
Havieron Mineral Resource report	2022_-_Havieron_-_2022_JUNE_-_FINAL_-_L1_-_Mineral_Resources.pdf	Jun-22
O'Callaghan's Mineral Resource Report	2022_-_O'Callaghans_-_2022_JUNE_-_FINAL_-_L1_-_Mineral_Resources.pdf	Jun-22
O'Callaghan's Mineral Resource Review	NEW037_O'Callaghans_Mineral Resource Review - 2018_Rev2.pdf	Jan-19
O'Callaghan's Mineral Resource Report	TEL_OCA_MR OR L3_July2010.pdf	Mar-10
O'Callaghan's Geology Model Update	O'Callaghans_Nov16_Geology_Model_Update_Tier3_Report_v1.docx	Nov-16
Camp Dome Exploration summary	Camp Dome exploration summary April 2011.docx	Apr-11
Satellites Deposits Mineral Resource Report	2022_-_Satellites_Deposits_-_2022_JUNE_-_FINAL_-_L1_-_Mineral_Resources.pdf	Jun-22
Metal Prices and Exchange Rates	2208 - Resource and Reserve Metal Price Assumptions Aug 2016 - FINAL.pdf	Aug-16
Telfer Satellites Resource Report	Telfer_Satellites_Mineral_Resource_Level3_Aug_2015_final.pdf	Aug-15
Telfer Open Pit Mineral Resource Report	2022 Telfer Open Pit FINAL L1 Mineral Resources.pdf	Jun-22
Telfer West Dome Open Pit: 2020 Annual Mineral Resource Review	NML 2020 MR Review Telfer WDO FINAL.pdf	Mar-21

Annexure 1. Independent Expert's Report

Newcrest - Independent Technical Specialist's Report

Grant Samuel & Associates Pty Ltd

0223041

Reference Name	Document Name	Document Date
Telfer/Havieron References		
Telfer West Dome Mineral Resource Report	Telfer West Dome Apr20_L3_DRAFT_v1.1.pdf	Apr-21
Telfer West Dome Mineral Resource Report	Telfer West Dome Feb21 Addendum to Apr20 Final.pdf	Feb-21
Telfer QAQC	Telfer QAQC Summary1July2019-31August2020.pdf	Aug-20
Telfer Underground Mineral Resource Report	2022_-_Telfer_Underground_-_2022_JUNE_-_FINAL_-_L1_-_Mineral_Resources.pdf	Jun-22
Telfer Underground Mineral Resource Review	P2021-13 NML 2020 MR Review Telfer MDU FINAL.pdf	Mar-21
Telfer Main Dome Underground Mineral Resource Review	TELFER MDU Aug 2020 L3 - FINAL Draft.pdf	Aug-20
Telfer M-Reef Mineral Resource Report	TEL_MD_MReefs_UG_L3_Jun20_Final.pdf	Jun-20

Reference Name	Document Name	Document Date
Brucejack References		
Brucejack 3-yr Actuals	Brucejack Actuals XLIT_Feb_23.xlsx	Mar-23
Brucejack Technical Report	NI 43-101 Technical Report on Brucejack Operations 9 March 2020.pdf	Mar-20
Pretium 2021 Annual Information Form	Annual Information Form of Pretium Resources Inc. - For The Year Ended December 31, 2020	Mar-21
Brucejack LOM Schedule	Brucejack "LOM Plan_2021.04.15-V00.dsf~ (Deswik Schedule file)	Apr-21
Brucejack Resource to Reserve Conversion	Brucejack Resource to Reserve Conversion Memo 20230629.pdf	Jun-20
Brucejack Grade Risk Assessment	Brucejack - Reserves - Grade Risk Adjustments - 17 May 2023.pdf	May-23
Brucejack 2023 Mineral Resource	RRSC Brucejack Resource Estimate memo 20230621.pdf	Jun-23
Brucejack 2023 Ore Reserves	FY23 Brucejack Reserves-Final Summary.xlsx	Unknown
Brucejack Resource and Reserve Context	Brucejack R&R Estimates Context 20230413.pdf	Apr-23
Brucejack Ore Sorting Update	Brucejack Ore Sorting Project Status Update.pdf	Mar-23
Brucejack Debottlenecking Concept Study	Brucejack Debottlenecking Concept Study Report	Nov-22
Brucejack Capital	Brucejack_Capital_Breakdown_BP.xlsx	2023
Brucejack Project Study Costs	Project Study Costs - FY23 Q3F.xlsx	

Reference Name	Document Name	Document Date
Red Chris References		
Red Chris 3-yr Actuals	RCO_3y actuals - Feb 23	Feb-23
Red Chris Technical Report	NI 43-101 Technical Report on Red Chris Operations as of 30 June 2021.pdf	Jul-21
Red Chris Tactical Schedule Base Case	RCO Tactical Schedule FY23Q1F_BCM_BC1_v3_20220506_Updated E.xlsx	Unknown

Newcrest - Independent Technical Specialist's Report

Grant Samuel & Associates Pty Ltd

0223041

Reference Name	Document Name	Document Date
Red Chris References		
Red Chris Tactical Schedule No Phase 8	RCO Tactical Schedule FY23Q3F_P75_v01_2021014_10Mtpa_Ph5R.xlsx	Unknown
Red Chris Metallurgical Testing	RF503_Row_19_BL0663 Report	Nov-21
Red Chris Metallurgical Processing Study	Volume 6.4 - Metallurgy & Processing_RC Block Cave PFS	Oct-21
Red Chris - Process Plant Flowsheet	Red Chris Flow Sheet	Apr-22
Red Chris TSF	TIA Design Report Update	May-22
Red Chris Infrastructure	Volume 6.6 - Infrastructure_RC Block Cave PFS	Oct-21
Red Chris Capital	Red Chris_Capital_Breakdown.xlsx	Unknown
Red Chris Annual Information Form	Annual Information Form of Newcrest Mining Limited for the Year Ended June 30, 2022	Dec-22

Reference Name	Document Name	Document Date
Namosi References		
Waisoi Mineral Resources	2022_-_Waisoi_Project_-_2022_JUNE_-_FINAL_-_L1_-_Mineral_Resources	2022
Waisoi January 2017 Resource Report	Waisoi January 2017 Resource Report - RevC	2017
Waisoi QAQC Report	Waisoi_QAQC_Report_June10_Final	2010
Wainaulo Mineral Resources	2022_-_Wainaulo_Project_-_2022_JUNE_-_FINAL_-_L1_-_Mineral_Resources	2022
Wainaulo June2010 Resource Report	Wainaulo June2010 Resource Report RevC	2010
Wainaulo Mineral resource evaluation	Wainaulo Mineral resource evaluation 10-12-18	2018

Annexure 1. Independent Expert's Report

Newcrest - Independent Technical Specialist's Report

Grant Samuel & Associates Pty Ltd

0223041

Our offices

Australia

Adelaide

Level 1, 12 Pirie Street
Adelaide SA 5000 Australia

T +61 8 8201 1800
E adelaide@amconsultants.com

Melbourne

Level 29, 140 William Street
Melbourne Vic 3000 Australia

T +61 3 8601 3300
E melbourne@amconsultants.com

Canada

Toronto

140 Yonge Street, Suite 200
Toronto ON M5C 1X6 Canada

T +1 647 953 9730
E toronto@amconsultants.com

Singapore

Singapore

9 Straits View
#05-07 Marina One (West Tower)
Singapore 018937

T +65 3157 9130
E singapore@amconsultants.com

Brisbane

Level 15, 100 Creek Street
Brisbane Qld 4000 Australia

T +61 7 3230 9000
E brisbane@amconsultants.com

Perth

Level 1, 1100 Hay Street
West Perth WA 6005 Australia

T +61 8 6330 1100
E perth@amconsultants.com

Vancouver

200 Granville Street, Suite 202
Vancouver BC V6C 1S4 Canada

T +1 604 669 0044
E vancouver@amconsultants.com

United Kingdom

Maidenhead

Registered in England and Wales
Company No. 3688365
Building 3, 1st Floor
Concorde Park, Concorde Road
Maidenhead SL6 4BY United Kingdom

T +44 1628 778 256
E maidenhead@amconsultants.com

Registered Office:
The Kinetic Centre
Theobald Street
Elstree
Hertfordshire WD6 4PG United Kingdom



**Building a better
working world**

Ernst & Young Strategy and Transactions
Limited
8 Exhibition Street
Melbourne VIC 3000 Australia
GPO Box 67 Melbourne VIC 3001

Tel: +61 3 9288 8000
Fax: +61 3 8650 7777
ey.com/au

The Board of Directors
Newcrest Mining Limited
Level 8, 600 St. Kilda Road
Melbourne, VIC, 3004
Australia

7 September 2023

The Board of Directors
Newmont Corporation
6900 E Layton Avenue
Suite 700, Denver
CO, 8023, USA

Dear Directors

PART 1 – INDEPENDENT LIMITED ASSURANCE REPORT ON NEWCREST HISTORICAL FINANCIAL INFORMATION, NEWMONT HISTORICAL FINANCIAL INFORMATION AND MERGED GROUP PRO FORMA HISTORICAL FINANCIAL INFORMATION

1. Introduction

We have been engaged by Newcrest Mining Limited (“Newcrest” or the “Newcrest Group”) and Newmont Corporation (“Newmont” or the “Newmont Group”) (together, the “Merged Group”) to report on each of the historical financial information of Newcrest and Newmont and the pro forma historical financial information of the Merged Group for inclusion in the scheme booklet to be dated 7 September 2023 (“Scheme Booklet”) and issued by Newcrest, in connection with a scheme of arrangement in relation to the proposed acquisition of Newcrest by Newmont Overseas Holdings Pty Ltd, a wholly owned indirect subsidiary of Newmont (the “Scheme”).

Expressions and terms defined in the Scheme Booklet have the same meaning in this report.

The nature of this report is such that it can only be issued by an entity which holds an Australian Financial Services Licence under the Corporations Act 2001. Ernst & Young Strategy and Transactions Limited (“Ernst & Young Strategy and Transactions”) holds an appropriate Australian Financial Services Licence (AFS Licence Number 240585). Paul Murphy is a Director and Representative of Ernst & Young Strategy and Transactions. We have included our Financial Services Guide as Part 2 of this report.



2. Scope

Newcrest Historical Financial Information

You have requested Ernst & Young Strategy and Transactions to review the following historical financial information of Newcrest:

- ▶ Newcrest historical consolidated income statements for the years ended 30 June 2023, 30 June 2022 and 30 June 2021 (“Newcrest Historical Statements of Operations”) as set out in Table 5.8.1 of Section 5.8(c) of the Scheme Booklet;
- ▶ Newcrest historical consolidated statement of financial position as at 30 June 2023 (“Newcrest Historical Balance Sheet”) as set out in Table 5.8.2 of Section 5.8(d) of the Scheme Booklet; and
- ▶ the Newcrest historical consolidated statements of cash flows for the years ended 30 June 2023, 30 June 2022 and 30 June 2021 (“Newcrest Historical Statements of Cash Flows”) as set out in Table 5.8.3 of Section 5.8(e) of the Scheme Booklet,

(Hereafter the “Newcrest Historical Financial Information”).

The Newcrest Historical Financial Information have been derived from the respective consolidated financial statements of the Newcrest Group for the years ended 30 June 2023 and 30 June 2022 (which includes comparative information for the year ended 30 June 2021) which were prepared in accordance with Australian Accounting Standards and were audited by Ernst & Young in accordance with Australian Auditing Standards. Ernst & Young issued unqualified audit opinions on these consolidated financial statements.

The Newcrest Historical Financial Information has been prepared in accordance with the stated basis of preparation, being the recognition and measurement principles of Australian Accounting Standards issued by the Australian Accounting Standards Board which are consistent with International Financial Reporting Standards issued by the International Accounting Standards Board.

Newmont Historical Financial Information

You have requested Ernst & Young Strategy and Transactions to review the following historical financial information of Newmont:

- ▶ Newmont historical consolidated statements of operations for the six months ended 30 June 2023 and the years ended 31 December 2022 and 31 December 2021 (“Newmont Historical Statements of Operations”) as set out in Table 6.15.1 of Section 6.15(c) of the Scheme Booklet;
- ▶ Newmont historical consolidated balance sheet as at 30 June 2023 (“Newmont Historical Balance Sheet”) as set out in Table 6.15.2 of Section 6.15(d) of the Scheme Booklet; and
- ▶ Newmont historical consolidated statements of cash flows for the six months ended 30 June 2023 and the years ended 31 December 2022 and 31 December 2021 (“Newmont Historical Statements of Cash Flows”) as set out in Table 6.15.3 of Section 6.15(e) of the Scheme Booklet,



(Hereafter the “Newmont Historical Financial Information”).

The Newmont Historical Financial Information for the years ended 31 December 2021 and 31 December 2022 has been derived from the consolidated financial statements of the Newmont Group prepared for the Newmont Annual Reports for the respective years, as updated by Newmont’s Current Report on Form 8-K, filed with the SEC on 20 July 2023. These consolidated financial statements were prepared in accordance with generally accepted accounting principles in the United States (“US GAAP”).

The Newmont Historical Financial Information as at and for the six months ended 30 June 2023 has been derived from the interim consolidated financial statements of the Newmont Group prepared for the Newmont 10-Q Quarterly Report for the quarter ended 30 June 2023. These interim consolidated financial statements in Newmont’s 10-Q Quarterly Report were prepared in accordance with US GAAP and the applicable rules and regulations of the Securities and Exchange Commission (“SEC”) for interim financial information. Ernst & Young LLP performs reviews of Newmont’s interim consolidated financial statements filed with the SEC in accordance with the standards of the Public Company Accounting Oversight Board (United States).

The consolidated financial statements of the Newmont Group for the years ended 31 December 2021 and 31 December 2022 were audited by Ernst & Young LLP in accordance with the standards of the Public Company Accounting Oversight Board (United States). Ernst & Young LLP issued unqualified audit opinions on these consolidated financial statements. The auditor’s report issued by Ernst & Young LLP notes that the financial statements of Nevada Gold Mines LLC, in which Newmont has a 38.5% owned investment and which is proportionately consolidated into Newmont, were audited by other auditors and Ernst & Young LLP’s audit opinions, insofar as it relates to the amounts included for Nevada Gold Mines LLC, is based solely on the reports of the other auditors.

The Newmont Historical Financial Information has been prepared in accordance with the stated basis of preparation, being in a manner consistent with Newmont Group accounting policies applied by Newmont in preparing the Newmont Quarterly Report for the quarter ended 30 June 2023 and the Annual Report for the year ended 31 December 2022.

Merged Group Pro Forma Historical Financial Information

You have requested Ernst & Young Strategy and Transactions to review the following pro forma historical financial information of the Merged Group:

- ▶ Merged Group pro forma historical statements of operations for the six months ended 30 June 2023 and the year ended 31 December 2022 (“Merged Group Pro Forma Historical Statements of Operations”) as set out in Table 7.7.1 of Section 7.7(c) of the Scheme Booklet; and
- ▶ Merged Group pro forma historical balance sheet as at 30 June 2023 (“Merged Group Pro Forma Historical Balance Sheet”) as set out in Table 7.7.4 of Section 7.7(d) of the Scheme Booklet,

(Hereafter the “Merged Group Pro Forma Historical Financial Information”).

The Merged Group Pro Forma Historical Financial Information presents the combination of the Newmont Historical Financial Information and the Newcrest Historical Financial Information after giving effect to the Scheme which is assumed to have occurred on 1 January 2022 for the Merged Group Pro Forma

Annexure 2. Independent Limited Assurance Report



Historical Statements of Operations and as at 30 June 2023 for the Merged Group Pro Forma Historical Balance Sheet.

The Merged Group Pro Forma Historical Statements of Operations for the year ended 31 December 2022 has been derived from the:

- (i) Newmont Historical Statements of Operations for the year ended 31 December 2022 as outlined in Section 6.15 of the Scheme Booklet;
- (ii) Newcrest Historical Statements of Operations for the year ended 30 June 2022 as outlined in Section 5.8 of the Scheme Booklet, adjusted to exclude the financial performance for the six months from 1 July 2021 to 31 December 2021 and include the financial performance for the six months from 1 July 2022 to 31 December 2022 based on the information in Newcrest's half year financial statements for the six months ended 31 December 2021 and 31 December 2022 respectively;
- (iii) Newcrest Historical Statements of Operations for the year ended 31 December 2022 as derived above further adjusted for reclassifications and US GAAP conversion and accounting policy adjustments, as detailed in Notes 2 and 3 of Section 7.7(e) of the Scheme Booklet; and
- (iv) adjusted for the effects of pro forma adjustments described in Note 4 Transaction Accounting Adjustments of Section 7.7(e) of the Scheme Booklet.

The Merged Group Pro Forma Historical Financial Information as at and for the six months ended 30 June 2023 has been derived from the:

- (i) Newmont Historical Balance Sheet as at 30 June 2023 and the Newmont Historical Statements of Operations for the six months ended 30 June 2023 as outlined in Section 6.15 of the Scheme Booklet;
- (ii) Newcrest Historical Balance Sheet as at 30 June 2023 and the Newcrest Historical Statements of Operations for the year ended 30 June 2023 as outlined in Section 5.8 of the Scheme Booklet, and for the purposes of the Merged Group Pro Forma Historical Statements of Operations, adjusted to exclude the financial performance for the six months from 1 July 2022 to 31 December 2022 based on the information in Newcrest's half year financial statements for the six months ended 31 December 2022;
- (iii) Newcrest Historical Balance Sheet as at 30 June 2023 and the Newcrest Historical Statements of Operations for the six months ended 30 June 2023 as derived above further adjusted for reclassifications and US GAAP conversion and accounting policy adjustments, as detailed in Notes 2 and 3 of Section 7.7(e) of the Scheme Booklet; and
- (iv) adjusted for the effects of pro forma adjustments described in Note 4 Transaction Accounting Adjustments of Section 7.7(e) of the Scheme Booklet.

Newcrest's interim consolidated financial statements for the six months ended 31 December 2021 and 31 December 2022 were reviewed by Ernst & Young and on which unqualified limited assurance conclusions were issued.

The Merged Group Pro Forma Historical Financial Information has been prepared in accordance with the stated basis of preparation, being in a manner consistent with Newmont Group accounting policies applied by Newmont in preparing the Newmont Quarterly Report for the quarter ended 30 June 2023



and the Annual Report for the year ended 31 December 2022, using the assumptions set out in Section 7.7(e) Notes to the Merged Group Pro Forma Historical Financial Information of the Scheme Booklet.

Due to its nature, the Merged Group Pro Forma Historical Financial Information does not represent the Merged Group's actual or prospective financial position and financial performance.

The Newcrest Historical Financial Information, Newmont Historical Financial Information and the Merged Group Pro Forma Historical Financial Information is presented in the Scheme Booklet in an abbreviated form, insofar as it does not include all of the presentation and disclosures required by US GAAP applicable to full financial statements prepared in accordance with the applicable rules and regulations of the SEC and the *Corporations Act 2001*.

3. Directors' Responsibility

The directors of Newcrest are responsible for the preparation and presentation of the Newcrest Historical Financial Information and Newmont management are responsible for the preparation and presentation of the Newmont Historical Financial Information and Merged Group Pro Forma Historical Financial Information, including the basis of preparation, selection and determination of pro forma adjustments made to the Newcrest Historical Financial Information and the Newmont Historical Financial Information and included in the Merged Group Pro Forma Historical Financial Information. This includes responsibility for such internal controls as the directors of Newcrest and Newmont management determine are necessary to enable the preparation of Newcrest Historical Financial Information, Newmont Historical Financial Information and Merged Group Pro Forma Historical Financial Information (as applicable) that are free from material misstatement, whether due to fraud or error.

4. Our Responsibility

Our responsibility is to express a limited assurance conclusion on the Newcrest Historical Financial Information, Newmont Historical Financial Information and Merged Group Pro Forma Historical Financial Information based on the procedures performed and the evidence we have obtained.

We have conducted our engagement in accordance with the Standard on Assurance Engagements ASAE 3450 *Assurance Engagements involving Corporate Fundraisings and/or Prospective Financial Information*.

Our limited assurance procedures consisted of making enquiries, primarily of persons responsible for financial and accounting matters, and applying analytical and other limited assurance procedures. A limited assurance engagement is substantially less in scope than an audit conducted in accordance with Australian Auditing Standards and consequently does not enable us to obtain reasonable assurance that we would become aware of all significant matters that might be identified in a reasonable assurance engagement. Accordingly, we do not express an audit opinion.

Our engagement did not involve updating or re-issuing any previously issued audit or limited assurance reports on any financial information used as a source of the Newcrest Historical Financial Information, Newmont Historical Financial Information and Merged Group Pro Forma Historical Financial Information.



5. Conclusions

Newcrest Historical Financial Information

Based on our limited assurance engagement, which is not an audit, nothing has come to our attention that causes us to believe that the Newcrest Historical Financial Information comprising the:

- ▶ Newcrest Historical Statements of Operations for the years ended 30 June 2023, 30 June 2022 and 30 June 2021 as set out in Table 5.8.1 of Section 5.8(c) of the Scheme Booklet;
- ▶ Newcrest Historical Balance Sheet as at 30 June 2023 as set out in Table 5.8.2 of Section 5.8(d) of the Scheme Booklet; and
- ▶ Newcrest Historical Statements of Cash Flows for the years ended 30 June 2023, 30 June 2022 and 30 June 2021 as set out in Table 5.8.3 of Section 5.8(e) of the Scheme Booklet,

is not presented fairly, in all material respects, in accordance with the stated basis of preparation, as described in Section 5.8(b) of the Scheme Booklet.

Newmont Historical Financial Information

Based on our limited assurance engagement, which is not an audit, nothing has come to our attention that causes us to believe that the Newmont Historical Financial Information comprising the:

- ▶ Newmont Historical Statements of Operations for the six months ended 30 June 2023 and the years ended 31 December 2022 and 31 December 2021 as set out in Table 6.15.1 of Section 6.15(c) of the Scheme Booklet;
- ▶ Newmont Historical Balance Sheet as at 30 June 2023 as set out in Table 6.15.2 of Section 6.15(d) of the Scheme Booklet; and
- ▶ Newmont Historical Statements of Cash Flows for the six months ended 30 June 2023 and the years ended 31 December 2022 and 31 December 2021 as set out in Table 6.15.3 of Section 6.15(e) of the Scheme Booklet,

is not presented fairly, in all material respects, in accordance with the stated basis of preparation, as described in Section 6.15(b) of the Scheme Booklet.

Merged Group Pro Forma Historical Financial Information

Based on our limited assurance engagement, which is not an audit, nothing has come to our attention that causes us to believe that the Merged Group Pro Forma Historical Financial Information comprising the:

- ▶ Merged Group Pro Forma Historical Statements of Operations for the six months ended 30 June 2023 and the year ended 31 December 2022 as set out in Table 7.7.1 of Section 7.7(c) of the Scheme Booklet; and



- ▶ Merged Group Pro Forma Historical Balance Sheet as at 30 June 2023 as set out in Table 7.7.4 of Section 7.7(d) of the Scheme Booklet,

is not presented fairly, in all material respects, in accordance with the stated basis of preparation, as described in Section 7.7(b) of the Scheme Booklet.

6. Restriction on Use

Without modifying our conclusions, we draw attention to Sections 5.8(b), 6.15(b) and 7.7(b) of the Scheme Booklet, which describes the purpose of the Newcrest Historical Financial Information, Newmont Historical Financial Information and Merged Group Pro Forma Historical Financial Information. As a result, the Newcrest Historical Financial Information, Newmont Historical Financial Information and Merged Group Pro Forma Historical Financial Information may not be suitable for use for another purpose.

7. Consent

Ernst & Young Strategy and Transactions has consented to the inclusion of this limited assurance report in the Scheme Booklet in the form and context in which it is included.

8. Independence or Disclosure of Interest

Ernst & Young Strategy and Transactions does not have any interests in the outcome of the Scheme other than in the preparation of this report for which normal professional fees will be received.

Yours faithfully

Ernst & Young Strategy and Transactions Limited

Paul Murphy
Director and Representative

Annexure 2. Independent Limited Assurance Report



Ernst & Young Strategy and Transactions Limited
8 Exhibition Street
Melbourne VIC 3000 Australia
GPO Box 67 Melbourne VIC 3001

Tel: +61 3 9288 8000
Fax: +61 3 8650 7777
ey.com/au

7 September 2023

THIS FINANCIAL SERVICES GUIDE FORMS PART OF THE INDEPENDENT LIMITED ASSURANCE REPORT

PART 2 – FINANCIAL SERVICES GUIDE

1. Ernst & Young Strategy and Transactions

Ernst & Young **Strategy and Transactions Limited** (“Ernst & Young Strategy and Transactions” or “we,” or “us” or “our”) has been engaged to provide general financial product advice in the form of an Independent Limited Assurance Report (“Report”) in connection with a financial product of another person. The Report is to be included in documentation being sent to you by that person.

2. Financial Services Guide

This Financial Services Guide (“FSG”) provides important information to help retail clients make a decision as to their use of the general financial product advice in a Report, information about us, the financial services we offer, our dispute resolution process and how we are remunerated.

3. Financial services we offer

We hold an Australian Financial Services Licence which authorises us to provide the following services:

- financial product advice in relation to securities, derivatives, general insurance, life insurance, managed investments, superannuation, and government debentures, stocks and bonds; and
- arranging to deal in securities.

4. General financial product advice

In our Report we provide general financial product advice. The advice in a Report does not take into account your personal objectives, financial situation or needs.

You should consider the appropriateness of a Report having regard to your own objectives, financial situation and needs before you act on the advice in a Report. Where the advice relates to the acquisition or possible acquisition of a financial product, you should also obtain an offer document relating to the financial product and consider that document before making any decision about whether to acquire the financial product.

We have been engaged to issue a Report in connection with a financial product of another person. Our Report will include a description of the circumstances of our engagement and identify the person who has engaged us. Although you have not engaged us directly, a copy of the Report will be provided to

A member firm of Ernst & Young Global Limited
Ernst & Young Strategy and Transactions Limited, ABN 87 003 599 844
Australian Financial Services Licence No. 240585
Liability limited by a scheme approved under Professional Standards Legislation

Page 8



you as a retail client because of your connection to the matters on which we have been engaged to report.

5. Remuneration for our services

We charge fees for providing Reports. These fees have been agreed with, and will be paid by, the person who engaged us to provide a Report. Our fees for Reports are based on a time cost or fixed fee basis. Our directors and employees providing financial services receive an annual salary, a performance bonus or profit share depending on their level of seniority. The estimated fee for this Report is \$315,000 (inclusive of GST).

Ernst & Young Strategy and Transactions is ultimately owned by Ernst & Young, which is a professional advisory and accounting practice. Ernst & Young may provide professional services, including audit, tax and financial advisory services, to the person who engaged us and receive fees for those services.

Except for the fees and benefits referred to above, Ernst & Young Strategy and Transactions, including any of its directors, employees or associated entities should not receive any fees or other benefits, directly or indirectly, for or in connection with the provision of a Report.

6. Associations with product issuers

Ernst & Young Strategy and Transactions and any of its associated entities may at any time provide professional services to financial product issuers in the ordinary course of business.

7. Responsibility

The liability of Ernst & Young Strategy and Transactions, if any, is limited to the contents of this Financial Services Guide and the Report.

8. Complaints process

As the holder of an Australian Financial Services Licence, we are required to have a system for handling complaints from persons to whom we provide financial services. All complaints must be in writing and addressed to the AFS Compliance Manager or the Chief Complaints Officer and sent to the address below. We will make every effort to resolve a complaint within 30 days of receiving the complaint. If the complaint has not been satisfactorily dealt with, the complaint can be referred to the Australian Financial Complaints Authority Limited.

9. Compensation Arrangements

Ernst & Young and its related entities hold Professional Indemnity insurance for the purpose of compensation should this become relevant. Representatives who have left the Ernst & Young's employment are covered by our insurances in respect of events occurring during their employment. These arrangements and the level of cover held by the Ernst & Young satisfy the requirements of section 912B of the Corporations Act 2001.

Annexure 2. Independent Limited Assurance Report



Contacting Ernst & Young Strategy and Transactions Limited	Contacting the Independent Dispute Resolution Scheme:
AFS Compliance Manager Ernst & Young 200 George Street Sydney NSW 2000 Telephone: (02) 9248 5555	Australian Financial Complaints Authority Limited GPO Box 3 Melbourne, VIC 3001 Telephone: 1800 931 678

This Financial Services Guide has been issued in accordance with ASIC Corporations (Financial Services Guides) Instrument 2015/541.



HERBERT
SMITH
FREEHILLS

Scheme of arrangement

Newcrest Mining Limited

Scheme Shareholders

80 Collins Street Melbourne Vic 3000 Australia
GPO Box 128A Melbourne Vic 3001 Australia

T +61 3 9288 1234 F +61 3 9288 1567
herbertsmithfreehills.com DX 240 Melbourne



HERBERT
SMITH
FREEHILLS

Scheme of arrangement

This scheme of arrangement is made under section 411 of the *Corporations Act 2001* (Cth)

Between the parties

Newcrest Mining Limited

ACN 005 683 625 of Level 8, 600 St Kilda Road, Melbourne VIC 3004

The **Scheme Shareholders**

1 Definitions, interpretation and scheme components

1.1 Definitions

The meanings of the terms used in this Scheme are set out below.

Term	Meaning
ASIC	the Australian Securities and Investments Commission.
ASX	ASX Limited ACN 008 624 691 and, where the context requires, the financial market that it operates.
Australian Register	that part of the register of members of Newcrest maintained in Australia on behalf of Newcrest by the Newcrest Australian Registry.
Business Day	a day that is not a Saturday, Sunday or a public holiday or bank holiday in Melbourne, Australia or Denver, Colorado, United States.
Canadian Register	that part of the register of members of Newcrest maintained in Canada on behalf of Newcrest by the Newcrest Canadian Registry.
CDN	CHESS Depository Nominees Pty Limited ACN 071 346 506.



Term	Meaning
CHESS	the Clearing House Electronic Subregister System operated by ASX Settlement Pty Ltd and ASX Clear Pty Limited.
CHESS Holding	has the meaning given in the Settlement Rules.
Corporations Act	the <i>Corporations Act 2001</i> (Cth).
Court	the Federal Court of Australia or such other court of competent jurisdiction under the Corporations Act agreed to in writing by Newcrest and Newmont.
Deed Poll	the deed poll under which each Newmont and Newmont Overseas covenants in favour of the Scheme Shareholders to perform the obligations attributed to it under this Scheme.
Effective	when used in relation to this Scheme, the coming into effect, under subsection 411(10) of the Corporations Act, of the order of the Court made under subparagraph 411(4)(b) of the Corporations Act in relation to this Scheme.
Effective Date	the date on which this Scheme becomes Effective.
End Date	has the meaning given in the Implementation Deed.
First Court Date	the first day on which an application made to the Court for an order under subsection 411(1) of the Corporations Act convening the Scheme Meeting is heard.
Government Agency	has the meaning given in the Implementation Deed.
Implementation Date	the fifth Business Day after the Scheme Record Date, or such other date after the Scheme Record Date as agreed in writing by Newcrest and Newmont or is ordered by the Court or required by ASX.
Implementation Deed	the scheme implementation deed dated 15 May 2023 between Newcrest, Newmont and Newmont Overseas, as amended from time to time.

Annexure 3. Scheme of Arrangement



HERBERT
SMITH
FREEHILLS

Term	Meaning
Ineligible Foreign Shareholder	<p>a Scheme Shareholder whose address shown in the Newcrest Share Register on the Scheme Record Date is a place outside:</p> <ol style="list-style-type: none">1 Australia and its external territories;2 Canada;3 New Zealand;4 Papua New Guinea;5 the United Kingdom;6 the United States;7 the European Union (excluding Austria);8 Guernsey;9 Hong Kong;10 Japan;11 Norway;12 Singapore;13 South Korea;14 Switzerland;15 the United Arab Emirates;16 the Isle of Man;17 Bermuda; and18 such other jurisdictions agreed in writing by Newmont and Newcrest, <p>unless Newmont (after consultation with Newcrest) determines that it is lawful and not unduly onerous or unduly impractical to issue that Scheme Shareholder with New Newmont Shares, New Newmont CDIs or New Newmont PDIs (as applicable) when this Scheme becomes Effective.</p>
Ineligible Foreign Shareholder Sale Facility	<p>means the facility to be conducted in accordance with clause 5.5(a).</p>
Issuer Sponsored Holding	<p>has the meaning given in the Settlement Rules.</p>
New Newmont CDI	<p>a CHESD Depository Interest, being a unit of beneficial ownership in a New Newmont Share (in the form of a CHESD Depository Interest) registered in the name of, or held by a custodian with beneficial ownership held by, CDN in accordance with the Settlement Rules, to be issued to Scheme Shareholders under this Scheme.</p>



HERBERT
SMITH
FREEHILLS

Term	Meaning
New Newmont PDI	a PETS Depositary Interest, being a unit of beneficial ownership in a New Newmont Share (in the form of a PETS Depositary Interest) registered in the name of PDN in accordance with the PNGX Business Rules, to be issued to Scheme Shareholders under this Scheme.
New Newmont Share	a fully paid Newmont Share to be issued to Scheme Shareholders under this Scheme.
Newcrest	Newcrest Mining Limited ACN 005 683 625.
Newcrest Australian Registry	Link Market Services Limited ACN 083 214 537.
Newcrest Canadian Registry	TSX Trust Company.
Newcrest PNG Registry	PNG Registries Limited.
Newcrest Registry	the Newcrest Australian Registry, Newcrest Canadian Registry and Newcrest PNG Registry, as applicable.
Newcrest Share	a fully paid ordinary share in the capital of Newcrest.
Newcrest Share Register	the register of members of Newcrest maintained by or on behalf of Newcrest in accordance with the Corporations Act and comprising the: <ol style="list-style-type: none"> 1 Australian Register; 2 Canadian Register; and 3 PNG Register.
Newcrest Shareholder	each person who is registered as the holder of a Newcrest Share in the Newcrest Share Register.
Newmont	Newmont Corporation of 6900 E.Layton Avenue, Suite 700, Denver, Colorado, 80237, United States of America.
Newmont Overseas	Newmont Overseas Holdings Pty Ltd ACN 667 845 454 of Level 5, 500 Hay Street, Subiaco WA 6008.
Newmont Share	a share of common stock of Newmont.

Annexure 3. Scheme of Arrangement



HERBERT
SMITH
FREEHILLS

Term	Meaning
Newmont Share Register	the register of shareholders maintained by Newmont or its agent.
NYSE	the New York Stock Exchange upon which the Newmont Shares are listed.
Operating Rules	the official operating rules of ASX.
PDN	the 'Depository Nominee' appointed under the PNGX Business Rules.
PETS	has the meaning given under the PNGX Business Rules.
PNG Register	that part of the register of members of Newcrest maintained in Papua New Guinea on behalf of Newcrest by the Newcrest PNG Registry.
PNGX	PNGX Markets Limited or, as the context requires, the financial market operated by it.
PNGX Business Rules	the Business Rules of the Port Moresby Stock Exchange, as amended, supplemented or replaced from time to time.
Relevant Newmont Shares	has the meaning given in clause 5.5(a)(1).
Registered Address	in relation to a Newcrest Shareholder, the address shown in the Newcrest Share Register as at the Scheme Record Date.
Sale Agent	the sale agent appointed under clause 4.4 of the Implementation Deed to sell the New Newmont Shares that are to be issued under clause 5.5(a)(1) of this Scheme.
Scheme	this scheme of arrangement under Part 5.1 of the Corporations Act between Newcrest and the Scheme Shareholders subject to any alterations or conditions made or required by the Court under subsection 411(6) of the Corporations Act, or proposed by a party, and in each case agreed to in writing by Newcrest and Newmont.



HERBERT
SMITH
FREEHILLS

Term	Meaning
Scheme Consideration	<p>the consideration to be provided by or on behalf of Newmont Overseas to each Scheme Shareholder for the transfer to Newmont Overseas of each Scheme Share, being:</p> <ol style="list-style-type: none"> 1 where the Scheme Shareholder is not an Ineligible Foreign Shareholder and holds Scheme Shares on: <ul style="list-style-type: none"> • the Canadian Register, 0.400 New Newmont Shares; • the Australian Register, 0.400 New Newmont CDIs; or • the PNG Register, 0.400 New Newmont PDIs; or 2 where the Scheme Shareholder is an Ineligible Foreign Shareholder, but subject at all times to clause 5.5, 0.400 New Newmont Shares, <p>for each Scheme Share held by the Scheme Shareholder on the relevant register.</p>
Scheme Meeting	<p>the meeting of Newcrest Shareholders ordered by the Court to be convened under subsection 411(1) of the Corporations Act to consider and vote on this Scheme and includes any meeting convened following any adjournment or postponement of that meeting.</p>
Scheme Record Date	<p>7.00pm on the eighth Business Day after the Effective Date or such other time and date as agreed in writing by Newcrest and Newmont.</p>
Scheme Shareholder	<p>a Newcrest Shareholder as at the Scheme Record Date, subject to clause 4.7 of the Implementation Deed.</p>
Scheme Shares	<p>all Newcrest Shares held by the Scheme Shareholders as at the Scheme Record Date.</p>
Scheme Transfer	<p>a duly completed and executed proper instrument of transfer in respect of the Scheme Shares for the purposes of section 1071B of the Corporations Act, in favour of Newmont Overseas as transferee, which will be a master transfer of all or part of the Scheme Shares.</p>
Second Court Date	<p>the first day on which an application made to the Court for an order under paragraph 411(4)(b) of the Corporations Act approving this Scheme is heard.</p>
Security Interest	<p>has the meaning given in the Implementation Deed.</p>
Settlement Rules	<p>the ASX Settlement Operating Rules, being the official operating rules of the settlement facility provided by ASX Settlement Pty Ltd.</p>

Annexure 3. Scheme of Arrangement



HERBERT
SMITH
FREEHILLS

Term	Meaning
TSX	Toronto Stock Exchange.
Unclaimed Money Act	the <i>Unclaimed Money Act 2008</i> (Vic).

1.2 Interpretation

In this Scheme:

- (a) headings and bold type are for convenience only and do not affect the interpretation of this Scheme;
- (b) the singular includes the plural and the plural includes the singular;
- (c) words of any gender include all genders;
- (d) other parts of speech and grammatical forms of a word or phrase defined in this Scheme have a corresponding meaning;
- (e) a reference to a person includes any company, partnership, joint venture, association, corporation or other body corporate and any Government Agency as well as an individual;
- (f) a reference to a clause, party, schedule, attachment or exhibit is a reference to a clause of, and a party, schedule, attachment or exhibit to, this Scheme;
- (g) a reference to any legislation includes all delegated legislation made under it and amendments, consolidations, replacements or reenactments of any of them (whether passed by the same or another Government Agency with legal power to do so);
- (h) a reference to a document (including this Scheme) includes all amendments or supplements to, or replacements or novations of, that document;
- (i) a reference to '\$', 'A\$' or 'dollar' is to Australian currency, and the methodology by which any amount in another currency is converted to Australian currency, must be as agreed by Newcrest and Newmont prior to the Implementation Date;
- (j) a reference to any time is, unless otherwise indicated, a reference to that time in Melbourne, Victoria;
- (k) a term defined in or for the purposes of the Corporations Act, and which is not defined in clause 1.1, has the same meaning when used in this Scheme;
- (l) a reference to a party to a document includes that party's successors and permitted assignees;
- (m) no provision of this Scheme will be construed adversely to a party because that party was responsible for the preparation of this Scheme or that provision;
- (n) any agreement, representation, warranty or indemnity in favour of two or more parties (including where two or more persons are included in the same defined term) is for the benefit of them jointly and severally;
- (o) a reference to a body, other than a party to this Scheme (including an institute, association or authority), whether statutory or not:
 - (1) which ceases to exist; or



HERBERT
SMITH
FREEHILLS

- (2) whose powers or functions are transferred to another body, is a reference to the body which replaces it or which substantially succeeds to its powers or functions;
- (p) if a period of time is specified and dates from a given day or the day of an act or event, it is to be calculated exclusive of that day;
- (q) a reference to a day is to be interpreted as the period of time commencing at midnight and ending 24 hours later;
- (r) if an act prescribed under this Scheme to be done by a party on or by a given day is done after 5.00pm on that day, it is taken to be done on the next day; and
- (s) a reference to the Operating Rules includes any variation, consolidation or replacement of these rules and is to be taken to be subject to any waiver or exemption granted to the compliance of those rules by a party.

1.3 Interpretation of inclusive expressions

Specifying anything in this Scheme after the words 'include' or 'for example' or similar expressions does not limit what else is included.

1.4 Reasonable endeavours

Any provision of this Scheme that requires a party to use reasonable endeavours or all reasonable endeavours, or to take all steps reasonably necessary, to ensure that something is performed or occurs or does not occur does not include any obligation:

- (a) to procure absolutely that that thing is done or happens;
- (b) to pay any money or to provide any financial compensation, valuable consideration or any other incentive to or for the benefit of any person:
 - (1) in the form of an inducement or consideration to a third party; or
 - (2) in circumstances that are commercially onerous or unreasonable in the context of this Scheme,

except for payment of any applicable fee for the lodgement or filing of any relevant application with any Government Agency or immaterial costs to procure that the thing is performed or occurs or does not occur;
- (c) to agree to commercially onerous or unreasonable terms in the context of the parties' intention to implement this Scheme; or
- (d) to commence any legal action or proceeding against any person.

1.5 Business Day

Where the day on or by which any thing is to be done is not a Business Day, that thing must be done on or by the next Business Day.

2 Preliminary matters

- (a) Newcrest is a public company limited by shares, incorporated in Australia and registered in Victoria, Australia. The Newcrest Shares are quoted for trading on the ASX, TSX and PNGX.

Annexure 3. Scheme of Arrangement



HERBERT
SMITH
FREEHILLS

- (b) Newmont is a corporation incorporated under the laws of the State of Delaware, United States. The Newmont Shares are officially listed on the NYSE and TSX.
- (c) Newmont Overseas is a proprietary company limited by shares, incorporated in Australia and registered in Western Australia, Australia.
- (d) Newcrest, Newmont and Newmont Overseas have agreed, by executing the Implementation Deed, to implement this Scheme on the terms and conditions of the Implementation Deed.
- (e) If this Scheme becomes Effective, each of the following will occur:
 - (1) all of the Scheme Shares, and all the rights and entitlements attaching to them as at the Implementation Date, will be transferred to Newmont Overseas on the Implementation Date;
 - (2) in consideration of the transfer of the Scheme Shares to Newmont Overseas, Newmont Overseas will provide or procure the provision of the Scheme Consideration to the Scheme Shareholders in accordance with this Scheme and the Deed Poll; and
 - (3) Newcrest will enter Newmont Overseas' name in the Newcrest Share Register as the holder of all of the Scheme Shares.
- (f) This Scheme attributes actions to Newmont and Newmont Overseas but does not itself impose an obligation on Newmont or Newmont Overseas to perform those actions. Each of Newmont and Newmont Overseas have undertaken, by executing the Deed Poll, to perform the actions attributed to it under this Scheme, including, in the case of Newmont Overseas, the provision or procuring the provision of the Scheme Consideration to the Scheme Shareholders subject to the terms and conditions of this Scheme.

3 Conditions

3.1 Conditions precedent

This Scheme is conditional on and will have no force or effect until, the satisfaction of each of the following conditions precedent:

- (a) all the conditions in clause 3.1 of the Implementation Deed (other than the condition in clause 3.1(l) of the Implementation Deed relating to Court approval of this Scheme) having been satisfied or waived in accordance with the terms of the Implementation Deed;
- (b) neither the Implementation Deed nor the Deed Poll having been terminated in accordance with their terms;
- (c) approval of this Scheme by the Court under paragraph 411(4)(b) of the Corporations Act, including with any alterations or conditions made or required by the Court under subsection 411(6) of the Corporations Act and agreed to by Newmont and Newcrest;
- (d) such other conditions made or required by the Court under subsection 411(6) of the Corporations Act in relation to this Scheme and agreed to by Newmont and Newcrest having been satisfied or waived; and
- (e) the orders of the Court made under paragraph 411(4)(b) (and, if applicable, subsection 411(6)) of the Corporations Act approving this Scheme coming into



HERBERT
SMITH
FREEHILLS

effect, pursuant to subsection 411(10) of the Corporations Act on or before the End Date (or any later date Newcrest and Newmont agree in writing).

3.2 Certificate

- (a) Newcrest and Newmont will each provide to the Court on the Second Court Date a certificate in a form agreed by Newcrest and Newmont, or such other evidence as the Court requests, confirming (in respect of matters within their knowledge) whether or not all of the conditions precedent in clauses 3.1(a) and 3.1(b) have been satisfied or waived (but in the case of the condition precedent in clause 3.1(a) only in respect of those conditions in clause 3.1 of the Implementation Deed (other than the condition relating to Court approval of this Scheme and the condition relating to the US Securities Act exemption) included for that party's benefit).
- (b) The certificates referred to in clause 3.2(a) constitute conclusive evidence (in the absence of manifest error) that such conditions precedent were satisfied, waived or taken to be waived.

3.3 End Date

Without limiting any rights under the Implementation Deed, this Scheme will lapse and be of no further force or effect if:

- (a) the Effective Date does not occur on or before 11.59pm on the End Date; or
- (b) the Implementation Deed or the Deed Poll is terminated in accordance with its terms,

unless Newcrest and Newmont otherwise agree in writing (and if required, as approved by the Court).

4 Implementation of this Scheme

4.1 Lodgement of Court orders with ASIC

Newcrest must lodge with ASIC an office copy of the Court order in accordance with subsection 411(10) of the Corporations Act approving this Scheme by no later than 5.00pm on the first Business Day after the date on which the Court order was made (or such later date as agreed in writing by Newmont).

4.2 Transfer of Scheme Shares

Subject to this Scheme becoming Effective in accordance with clause 4.1, the following actions must occur (in the order set out below) on the Implementation Date:

- (a) subject to the provision of the Scheme Consideration in the manner contemplated by clause 5.2, the Scheme Shares, together with all rights and entitlements attaching to the Scheme Shares as at the Implementation Date, must be transferred to Newmont Overseas, without the need for any further act by any Scheme Shareholder (other than acts performed by Newcrest or any of its directors or officers as attorney and agent for Scheme Shareholders under clause 9.5), by
 - (1) Newcrest delivering to Newmont Overseas a separate, duly completed Scheme Transfer for each of the Australian Register,

Annexure 3. Scheme of Arrangement



HERBERT
SMITH
FREEHILLS

- Canadian Register and the PNG Register, executed on behalf of the Scheme Shareholders (as transferors) by Newcrest; and
- (2) Newmont Overseas duly executing each Scheme Transfer (as transferee), attending to the stamping of each Scheme Transfer (if required) and delivering it to Newcrest for registration;
- (b) immediately following receipt of each duly executed Scheme Transfer in accordance with clause 4.2(a)(2), but subject to the stamping of each Scheme Transfer (if required), Newcrest must enter, or procure the entry of, the name of Newmont Overseas in the Newcrest Share Register as the registered holder of all the Scheme Shares on the Newcrest Share Register transferred to Newmont in accordance with this Scheme; and
- (c) the Scheme Shares (including all rights and entitlements attaching to the Scheme Shares) transferred under this Scheme to Newmont Overseas will, at the time of transfer of them to Newmont Overseas, vest in Newmont Overseas free from all mortgages, charges, liens, encumbrances, pledges, security interests (including any Security Interests) and interests of third parties of any kind, whether legal or otherwise, and restrictions on transfer of any kind.

5 Scheme Consideration

5.1 Scheme Consideration

- (a) On the Implementation Date, in consideration for the transfer of Scheme Shares to Newmont Overseas under this Scheme:
- (1) each Scheme Shareholder will be entitled to receive the Scheme Consideration in respect of the Scheme Shares held by that Scheme Shareholder; and
- (2) Newmont Overseas must provide, or procure the provision of, the Scheme Consideration to Scheme Shareholders (or the Sale Agent in accordance with clause 5.5),
- subject to and in accordance with this clause 5.
- (b) Subject to the terms and conditions of this Scheme, the Scheme Consideration to be provided to each Scheme Shareholder will be provided by the issue by Newmont of the Scheme Consideration comprising New Newmont Shares, New Newmont CDIs or New Newmont PDIs (as applicable) to that Scheme Shareholder on the Implementation Date

5.2 Provision of Scheme Consideration

Subject to clauses 5.3, 5.4, 5.5 and 5.6, the obligation of Newmont Overseas to provide, or procure the provision of, the Scheme Consideration to the Scheme Shareholders will be satisfied:

- (a) where the Scheme Consideration that is required to be provided to Scheme Shareholders is in the form of New Newmont Shares, by Newmont:
- (1) on the Implementation Date, issuing the Scheme Consideration comprising New Newmont Shares to each Scheme Shareholder and procuring that the name and address of the Scheme Shareholder is entered in the Newmont Share Register in respect of those New Newmont Shares; and



HERBERT
SMITH
FREEHILLS

- (2) procuring that on or before the date that is 5 Business Days after the Implementation Date, a holding statement (or equivalent document) is sent to the Registered Address of each Scheme Shareholder representing the number of New Newmont Shares issued to the Scheme Shareholder pursuant to this Scheme;
- (b) where the Scheme Consideration that is required to be provided to Scheme Shareholders is in the form of New Newmont CDIs, by Newmont:
- (1) issuing to CDN to be held on trust that number of New Newmont Shares that will enable Newmont to issue New Newmont CDIs as required by clause 5.2(b)(3) on the Implementation Date;
 - (2) procuring that the name and address of CDN is entered into the Newmont Share Register in respect of those New Newmont Shares on the Implementation Date;
 - (3) procuring that on the Implementation Date, Newmont issues to each such Scheme Shareholder the number of New Newmont CDIs to which it is entitled under this Scheme;
 - (4) procuring that on the Implementation Date, the name of each such Scheme Shareholder is entered in the records maintained by Newmont as being the holder of the New Newmont CDIs issued to that Scheme Shareholder on the Implementation Date and in the case of each such Scheme Shareholder who held Scheme Shares on the:
 - (A) CHESSE subregister, procuring that the New Newmont CDIs are held on the CHESSE subregister on the Implementation Date and on the next Business Day sending or procuring the sending of an allotment advice to each such Scheme Shareholder which sets out the number of New Newmont CDIs held on the CHESSE subregister; and
 - (B) issuer sponsored subregister, procuring that the New Newmont CDIs are held on the issuer sponsored subregister on the Implementation Date and on the next Business Day sending or procuring the sending of a CDI holding statement to each such Scheme Shareholder which sets out the number of New Newmont CDIs held on the issuer sponsored subregister,

by that Scheme Shareholder; and
- (c) where the Scheme Consideration that is required to be provided to Scheme Shareholders is in the form of New Newmont PDIs, by Newmont:
- (1) issuing to PDN to be held on trust that number of New Newmont Shares that will enable Newmont to issue New Newmont PDIs as required by clause 5.2(c)(3) on the Implementation Date;
 - (2) procuring that the name and address of PDN is entered into the Newmont Share Register in respect of those New Newmont Shares on the Implementation Date;
 - (3) procuring that on the Implementation Date, Newmont issues to each such Scheme Shareholder the number of New Newmont PDIs to which it is entitled under this Scheme;
 - (4) procuring that on the Implementation Date, the name of each such Scheme Shareholder is entered in the records maintained by Newmont as being the holder of the New Newmont PDIs issued to that Scheme Shareholder on the Implementation Date and procuring



HERBERT
SMITH
FREEHILLS

that the New Newmont PDIs are held on the issuer sponsored subregister on the Implementation Date and on the next Business Day sending or procuring the sending of a PDI holding statement to each such Scheme Shareholder which sets out the number of New Newmont PDIs held on the issuer sponsored subregister by that Scheme Shareholder,

provided that where the Scheme Shareholder is HSBC Custody Nominees (Australia) Limited (as custodian for Bank of New York Mellon in its capacity as the depository of Newcrest's American depository receipt (**ADR**) program) the Scheme Consideration will be issued to the depository in the form of New Newmont Shares, and the obligation of Newmont to provide such Scheme Consideration will be satisfied by Newmont issuing New Newmont Shares in accordance with clause 5.2(a).

5.3 Fractional entitlements and splitting

- (a) Where the calculation of the number of New Newmont Shares, New Newmont CDIs or New Newmont PDIs to be issued to a particular Scheme Shareholder would result in the Scheme Shareholder becoming entitled to a fraction of a New Newmont Share, New Newmont CDI or New Newmont PDI, then the fractional entitlement will be rounded to the nearest whole number of New Newmont Shares, New Newmont CDIs or New Newmont PDIs (as applicable), with any such fractional entitlement of:
- (1) less than 0.5 being rounded down; and
 - (2) 0.5 or more being rounded up,
- to the nearest whole number of New Newmont Shares, New Newmont CDIs or New Newmont PDIs (as applicable).
- (b) If Newcrest considers that several Scheme Shareholders, each of which holds a holding of Newcrest Shares which results in a fractional entitlement to New Newmont Shares, New Newmont CDIs or New Newmont PDIs have, before the Scheme Record Date, been party to a shareholding splitting or division in an attempt to obtain an advantage by reference to the rounding provided for in the calculation of each Scheme Shareholder's entitlement to the Scheme Consideration, Newcrest must provide the relevant details of the relevant Scheme Shareholder to Newmont, and Newmont and Newcrest may give notice to those Scheme Shareholders:
- (1) setting out the names and Registered Addresses of all of them;
 - (2) stating that opinion; and
 - (3) attributing to one of them specifically identified in the notice the Newcrest Shares held by all of them,
- and, after the notice has been so given, the Scheme Shareholder specifically identified in the notice shall, for the purposes of this Scheme, be taken to hold all those Newcrest Shares and each of the other Scheme Shareholders whose names are set out in the notice shall, for the purposes of this Scheme, be taken to hold no Newcrest Shares.

5.4 Joint holders

In the case of Scheme Shares held in joint names:

- (a) the New Newmont Shares, New Newmont CDIs or New Newmont PDIs (as applicable) to be issued under this Scheme must be issued to and registered in the names of the joint holders and entry in the Newmont Share Register must



HERBERT
SMITH
FREEHILLS

take place in the same order as the holders' names appear in the Newcrest Share Register;

- (b) any cheque required to be sent under this Scheme will be made payable to the joint holders and sent to the address for the joint holders recorded in the Newcrest Share Register as at the Scheme Record Date; and
- (c) any other document required to be sent under this Scheme, will be forwarded to the address for the joint holders recorded in the Newcrest Share Register as at the Scheme Record Date.

5.5 Ineligible Foreign Shareholders

- (a) Newmont has no obligation to issue any New Newmont Shares, New Newmont CDIs or New Newmont PDIs under this Scheme to any Ineligible Foreign Shareholder and instead:
 - (1) subject to clauses 5.3 and 5.6, Newmont must, on or before the Implementation Date, issue the New Newmont Shares, New Newmont CDIs or New Newmont PDIs which would otherwise be required to be issued to the Ineligible Foreign Shareholders (**Relevant Newmont Shares**) under this Scheme to the Sale Agent in the form of New Newmont Shares only (and not in form of New Newmont CDIs or New Newmont PDIs);
 - (2) Newmont Overseas must procure that as soon as reasonably practicable (and in any event within 15 days on which Newmont Shares are capable of being traded on NYSE) after the Implementation Date, the Sale Agent:
 - (A) in consultation with Newmont, sells or procures the sale of the Relevant Newmont Shares in the ordinary course of trading on the NYSE and in such manner, at such price and on such other terms as the Sale Agent reasonably determines; and
 - (B) as soon as reasonably practicable after settlement (and in any event within 10 Business Days), remits to Newmont Overseas the proceeds of the sale (after deduction of any reasonable brokerage or other selling costs, taxes and charges) (**Proceeds**);
 - (3) promptly after receiving the Proceeds in respect of the sale of all of the Relevant Newmont Shares in accordance with clause 5.5(a)(2), Newmont Overseas must pay, or procure the payment of, to each Ineligible Foreign Shareholder, the amount 'A' calculated in accordance with the following formula and rounded down to the nearest cent:

$$A = \left(\frac{B}{C} \right) \times D$$

where

A = the amount to be paid to the relevant Ineligible Foreign Shareholder;

B = the number of Relevant Newmont Shares attributable to, and that would otherwise have been issued to, that Ineligible Foreign Shareholder had it not been an Ineligible Foreign Shareholder and which were instead issued to the Sale Agent;

Annexure 3. Scheme of Arrangement



HERBERT
SMITH
FREEHILLS

C = the total number of Relevant Newmont Shares attributable to, and which would otherwise have been issued to, all Ineligible Foreign Shareholders collectively and which were issued to the Sale Agent; and

D = the Proceeds (as defined in clause 5.5(a)(2)(B)).

- (b) The Ineligible Foreign Shareholders acknowledge that none of Newmont, Newmont Overseas, Newcrest or the Sale Agent gives any assurance or representation as to the price that will be achieved for the sale of New Newmont Shares described in clause 5.5(a) or the amount of proceeds of sale to be received by Ineligible Foreign Shareholders under the Ineligible Foreign Shareholder Sale Facility. Each of Newcrest, Newmont or Newmont Overseas and the Sale Agent expressly disclaim any fiduciary duty to the Ineligible Foreign Shareholders which may arise in connection with this clause 5.5.
- (c) Newmont or Newmont Overseas must make, or procure the making of, payments to Ineligible Foreign Shareholders under clause 5.5(a) by either (in the absolute discretion of Newmont or Newmont Overseas, and despite any election referred to in clause 5.5(c)(2) or authority referred to in clause 5.5(c)(1) made or given by the Scheme Shareholder):
- (1) paying, or procuring the payment of, the relevant amount in dollars by electronic means to a bank account nominated by the Ineligible Foreign Shareholder by an appropriate authority from the Ineligible Foreign Shareholder to Newmont or Newmont Overseas; or
 - (2) if a bank account has not been nominated by the Ineligible Foreign Shareholder in accordance with clause 5.5(c)(1):
 - (A) if an Ineligible Foreign Shareholder has, before the Scheme Record Date, made a valid election in accordance with the requirements of the Newcrest Registry to receive dividend payments from Newcrest by electronic funds transfer to a bank account nominated by the Ineligible Foreign Shareholder, paying, or procuring the payment of, the relevant amount in dollars by electronic means in accordance with that election; or
 - (B) otherwise dispatching, or procuring the dispatch of, a cheque for the relevant amount in dollars to the Ineligible Foreign Shareholder by prepaid post to their Registered Address (as at the Scheme Record Date), such cheque being drawn in the name of the Ineligible Foreign Shareholder (or in the case of joint holders, in accordance with the procedures set out in clause 5.3).
- (d) If Newmont or Newmont Overseas receives professional advice that any withholding or other tax is required by law or by a Government Agency to be withheld from a payment to an Ineligible Foreign Shareholder, Newmont is entitled to withhold the relevant amount before making the payment to the Ineligible Foreign Shareholder (and payment of the reduced amount shall be taken to be full payment of the relevant amount for the purposes of this Scheme, including clause 5.5(a)(3)). Newmont or Newmont Overseas must pay any amount so withheld to the relevant taxation authorities within the time permitted by law, and, if requested in writing by the relevant Ineligible Foreign Shareholder, provide a receipt or other appropriate evidence of such payment (or procure the provision of such receipt or other evidence) to the relevant Ineligible Foreign Shareholder.



HERBERT
SMITH
FREEHILLS

- (e) Each Ineligible Foreign Shareholder appoints Newmont as its agent to receive on its behalf any financial services guide (or similar or equivalent document) or other notices (including any updates of those documents) that the Sale Agent is required to provide to Ineligible Foreign Shareholders under the Corporations Act or any other applicable law.
- (f) Payment of the amount 'A' calculated in accordance with clause 5.5(a) to an Ineligible Foreign Shareholder in accordance with this clause 5.5 satisfies in full the Ineligible Foreign Shareholder's right to Scheme Consideration and interest will not be paid on any proceeds.

5.6 Orders of a court or Government Agency

If a law requires, or if written notice is given to Newcrest (or the Newcrest Registry) or Newmont (or the Newmont share registry) of an order or direction made by a court of competent jurisdiction or by another Government Agency that:

- (a) requires consideration to be provided to a third party (either through payment of a sum or the issuance of a security) in respect of Scheme Shares held by a particular Scheme Shareholder, which would otherwise be payable or required to be issued to that Scheme Shareholder by Newcrest or Newmont in accordance with this clause 5, or which requires an amount to be deducted or withheld from any consideration which would otherwise be payable or provided to a Scheme Shareholder in accordance with this clause 5, then Newcrest or Newmont (as applicable) shall be entitled to procure that provision of that consideration, or deduction or withholding, is made in accordance with that order or direction; or
- (b) prevents Newcrest or Newmont from providing consideration to any particular Scheme Shareholder in accordance with this clause 5, or the payment or issuance of such consideration is otherwise prohibited by applicable law, Newcrest or Newmont shall be entitled to (as applicable):
 - (1) in the case of an Ineligible Foreign Shareholder or other shareholder referred to in clause 5.5, retain an amount, in dollars, equal to the relevant shareholder's share of the Proceeds; or
 - (2) not to issue (or direct Newmont to issue), or to issue to a trustee or nominee, such number of New Newmont Shares, New Newmont CDIs or New Newmont PDIs as that Scheme Shareholder would otherwise be entitled under clause 5.2,

until such time as provision of the Scheme Consideration in accordance with this clause 5 is permitted by that (or another) order or direction or otherwise by law.

To the extent that amounts are deducted or withheld under or in accordance with this clause 5.6, such deducted or withheld amounts will be treated for all purposes under this Scheme as having been paid to the person in respect of which such deduction or withhold was made.

5.7 Unclaimed monies

- (a) Newmont or Newmont Overseas may cancel a cheque issued under clause 5.5(c)(2)(B) if the cheque:
 - (1) is returned to Newcrest or Newmont Overseas; or
 - (2) has not been presented for payment within 6 months after the date on which the cheque was sent.



HERBERT
SMITH
FREEHILLS

- (b) During the period of 12 months commencing on the Implementation Date, on request in writing from a Scheme Shareholder to Newcrest or Newmont Overseas (or the Newcrest Registry) (which request may not be made until the date that is 20 Business Days after the Implementation Date), Newmont or Newmont Overseas must reissue a cheque that was previously cancelled under clause 5.7(a).
- (c) The Unclaimed Money Act will apply in relation to any Scheme Consideration that becomes “unclaimed money” (as defined in section 6 of the Unclaimed Money Act), but any interest or other benefit accrued from the unclaimed Scheme Consideration will be for the benefit of Newmont Overseas.

5.8 Status of New Newmont Shares, New Newmont CDIs and New Newmont PDIs

- (a) Newmont covenants in favour of Newcrest (in its own right and on behalf of the Scheme Shareholders) that the New Newmont Shares (including those issued in connection with New Newmont CDIs or New Newmont PDIs) required to be issued by it under this Scheme will:
 - (1) rank equally in all respects with all other Newmont Shares on issue;
 - (2) be duly and validly issued in accordance with all applicable laws and Newmont’s certificate of incorporation, by-laws and other constituent documents, fully paid and free from any mortgage, charge, lien, encumbrance or other security interest;
 - (3) be entitled to participate in and receive any dividends or distribution of capital paid and any other entitlements accruing in respect of Newmont Shares on and from the Implementation Date; and
 - (4) be fully paid and free of any Security Interest or encumbrance.
- (b) Newmont will use its reasonable endeavours to ensure that the:
 - (1) New Newmont Shares issued as Scheme Consideration will commence trading on a normal settlement basis on NYSE and TSX from the first Business Day after the Implementation Date (New York time);
 - (2) New Newmont CDIs issued as Scheme Consideration will be listed for quotation on the official list of ASX with effect from the seventh Business Day after the Effective Date (or such later date as ASX may require), initially on a deferred settlement basis and, with effect from no later than the first Business Day after the Implementation Date, on an ordinary (T+2) settlement basis; and
 - (3) New Newmont PDIs issued as Scheme Consideration will be listed for quotation on the official list of PNGX with effect from the seventh Business Day after the Effective Date (or such later date as PNGX may require), initially on a deferred settlement basis and, with effect from no later than the first Business Day after the Implementation Date, on an ordinary (T+2) settlement basis.



HERBERT
SMITH
FREEHILLS

6 Dealings in Newcrest Shares

6.1 Determination of Scheme Shareholders

To establish the identity of the Scheme Shareholders, dealings in Newcrest Shares or other alterations to the Newcrest Share Register will only be recognised if:

- (a) in the case of dealings of the type to be effected using CHES, the transferee is registered in the Newcrest Share Register as the holder of the relevant Newcrest Shares on or before the Scheme Record Date; and
- (b) in all other cases, registrable transfer or transmission applications in respect of those dealings, or valid requests in respect of other alterations, are received on or before the Scheme Record Date at the place where the Newcrest Share Register is kept,

and Newcrest must not accept for registration, nor recognise for any purpose (except a transfer to Newmont Overseas pursuant to this Scheme and any subsequent transfer by Newmont Overseas or its successors in title), any transfer or transmission application or other request received after the Scheme Record Date, or received prior to such times but not in registrable or actionable form, as appropriate.

6.2 Register

- (a) Newcrest must register registrable transmission applications or transfers of the Newcrest Shares that are received in accordance with clause 6.1(b) on or before the Scheme Record Date provided that, for the avoidance of doubt, nothing in this clause 6.2(a) requires Newcrest to register a transfer that would result in a Newcrest Shareholder holding a parcel of Newcrest Shares that is less than a 'marketable parcel' (for the purposes of this clause 6.2(a) 'marketable parcel' has the meaning given in the Operating Rules).
- (b) If this Scheme becomes Effective, a Scheme Shareholder (and any person claiming through that holder) must not dispose of or transfer or otherwise deal with, or purport or agree to dispose of or transfer or otherwise deal with, any Scheme Shares or any interest in them after the Scheme Record Date otherwise than pursuant to this Scheme, and any attempt to do so will have no legal effect and Newcrest shall be entitled to disregard any such disposal, transfer, purported disposal, transfer or agreement or dealing.
- (c) For the purpose of determining entitlements to the Scheme Consideration, Newcrest must maintain the Newcrest Share Register in accordance with the provisions of this clause 6.2 until the Scheme Consideration has been provided to the Scheme Shareholders and Newmont Overseas has been entered in the Newcrest Share Register as the holder of all the Scheme Shares. The Newcrest Share Register in this form will solely determine entitlements to the Scheme Consideration.
- (d) Subject to provision of the Scheme Consideration and registration of the transfer of the Scheme Shares to Newmont Overseas in accordance with this Scheme, all statements of holding or share certificates for Newcrest Shares (other than statements of holding in favour of Newmont Overseas or its successors in title) will cease to have effect as from the Scheme Record Date as documents of title in respect of those shares and, as from that date, each entry current at that date on the Newcrest Share Register (other than entries on the Newcrest Share Register in respect of Newmont Overseas or its successors in title) will cease to have effect except as evidence of entitlement to the Scheme Consideration in respect of the Newcrest Shares relating to that entry.

Annexure 3. Scheme of Arrangement



HERBERT
SMITH
FREEHILLS

- (e) As soon as possible on or after the Scheme Record Date, and in any event by 5.00pm on the third Business Day after the Scheme Record Date, Newcrest will ensure that details of the names, Registered Addresses and holdings of Newcrest Shares for each Scheme Shareholder as shown in the Newcrest Share Register are available to Newmont in the form Newmont reasonably requires.
- (f) Without limiting Newcrest's obligations under clause 6.2(e), Newcrest must provide, or procure the provision, to Newmont, such other information as Newmont may reasonably require in connection with the provision of the Scheme Consideration to the Scheme Shareholders in accordance with this Scheme.
- (g) Each Scheme Shareholder agrees that the information referred to in clause 6.2(e) may be disclosed to Newmont, the Newmont share registry and Newmont's advisers and other service providers to the extent necessary to effect this Scheme.

7 Quotation of Newcrest Shares

- (a) Newcrest must apply to ASX, PNGX and TSX to suspend trading in Newcrest Shares with effect from the close of trading (on the ASX) on the sixth Business Day after Effective Date.
- (b) On a date after the Implementation Date to be determined by Newmont, Newcrest must apply:
 - (1) for termination of the quotation of Newcrest Shares on the ASX, PNGX and TSX; and
 - (2) to have itself removed from the ASX, PNGX and TSX.

8 Instructions and elections

If not prohibited by law (and including where permitted or facilitated by relief granted by a Government Agency), all instructions, notifications or elections by a Scheme Shareholder to Newcrest that are binding or deemed binding between the Scheme Shareholder and Newcrest relating to Newcrest or Newcrest Shares, including instructions, notifications or elections relating to:

- (a) whether dividends are to be paid by cheque or into a specific bank account;
- (b) payments of dividends on Newcrest Shares; and
- (c) notices or other communications from Newcrest (including by email),

will be deemed from the Implementation Date (except to the extent determined otherwise by Newmont in its sole discretion), by reason of this Scheme, to be made by the Scheme Shareholder to Newmont and to be a binding instruction, notification or election to, and accepted by, Newmont in respect of the New Newmont Shares, New Newmont CDIs or New Newmont PDIs issued to that Scheme Shareholder until that instruction, notification or election is revoked or amended in writing addressed to Newmont at its registry.



HERBERT
SMITH
FREEHILLS

9 General Scheme provisions

9.1 Consent to amendments to this Scheme

If the Court proposes to approve this Scheme subject to any alterations or conditions:

- (a) Newcrest may by its counsel consent on behalf of all persons concerned to those alterations or conditions to which Newmont (for and on behalf of Newmont and Newmont Overseas) has consented to in writing; and
- (b) each Scheme Shareholder agrees to any such alterations or conditions which Newcrest (by its counsel) has consented to.

9.2 Scheme Shareholders' agreements and warranties

- (a) Each Scheme Shareholder:
 - (1) agrees for all purposes to:
 - (A) the transfer of their Newcrest Shares together with all rights and entitlements attaching to those Newcrest Shares in accordance with this Scheme;
 - (B) the variation, cancellation or modification (if any) of the rights attached to their Newcrest Shares constituted by or resulting from this Scheme;
 - (C) on the direction of Newmont, destroy any share certificates or holding statements relating to their Newcrest Shares;
 - (2) that is issued New Newmont Shares, New Newmont CDIs or New Newmont PDIs, agrees to become a member of Newmont and to be bound by the certificate of incorporation, by-laws and other constituent documents of Newmont;
 - (3) agrees to the transfer of their Newcrest Shares from one part of the Newcrest Share Register to another part of the Newcrest Share Register in connection with the Scheme, it being recognised that no such transfer would be undertaken in respect of the PNG Register;
 - (4) who holds their Newcrest Shares in a CHESS Holding, agrees to the conversion of those Newcrest Shares to an Issuer Sponsored Holding and irrevocably authorises Newcrest to do anything necessary or expedient (whether required by the Settlement Rules or otherwise) to effect or facilitate such conversion; and
 - (5) acknowledges and agrees that this Scheme binds Newcrest and all Scheme Shareholders (including those who do not attend the Scheme Meeting and those who do not vote, or vote against this Scheme, at the Scheme Meeting),

in each case, irrevocably and without the need for any further act by the Scheme Shareholder.
- (b) Each Scheme Shareholder is taken to have warranted to Newcrest and Newmont Overseas on the Implementation Date, and appointed and authorised Newcrest as its attorney and agent to warrant to Newmont Overseas on the Implementation Date, that:
 - (1) all their Newcrest Shares (including any rights and entitlements attaching to those shares) which are transferred to Newmont



HERBERT
SMITH
FREEHILLS

- Overseas under this Scheme will, at the time of transfer of them to Newmont Overseas, be fully paid and free from all mortgages, charges, liens, encumbrances, pledges, security interests (including any Security Interests) and interests of third parties of any kind, whether legal or otherwise, and restrictions on transfer of any kind;
- (2) they have full power and capacity to sell and transfer their Newcrest Shares to Newmont Overseas under this Scheme together with any rights and entitlements attaching to those shares; and
 - (3) they have no existing right to be issued any Newcrest Shares, or any options, performance rights, securities or other instruments exercisable, or convertible, into Newcrest Shares.
- (c) Newcrest undertakes that it will provide such warranty in clause 9.2(b) to Newmont Overseas as agent and attorney of each Scheme Shareholder.

9.3 Title to and rights in Scheme Shares

- (a) To the extent permitted by law, the Scheme Shares (including all rights and entitlements attaching to the Scheme Shares) transferred under this Scheme to Newmont Overseas will, at the time of transfer of them to Newmont Overseas vest in Newmont Overseas free from all mortgages, charges, liens, encumbrances, pledges, security interests (including any Security Interests) and interests of third parties of any kind, whether legal or otherwise and free from any restrictions on transfer of any kind.
- (b) Immediately upon the provision of the Scheme Consideration to each Scheme Shareholder in the manner contemplated by clause 5.2 Newmont Overseas will be beneficially entitled to the Scheme Shares to be transferred to it under this Scheme pending registration by Newcrest of Newmont Overseas in the Newcrest Share Register as the holder of the Scheme Shares.

9.4 Appointment of sole proxy

Immediately upon the provision of the Scheme Consideration to each Scheme Shareholder in the manner contemplated by clause 5.2 and until Newcrest registers Newmont Overseas as the holder of all Scheme Shares in the Newcrest Share Register, each Scheme Shareholder:

- (a) is deemed to have irrevocably appointed Newmont Overseas as attorney and agent (and directed Newmont Overseas in each such capacity) to appoint any director, officer, secretary or agent nominated by Newmont Overseas from time to time as its sole proxy and, where applicable or appropriate, corporate representative to attend shareholders' meetings, exercise the votes attaching to the Scheme Shares registered in their name and sign any shareholders' resolution or document (whether in person, by proxy or corporate representative);
- (b) must not attend or vote at any of those meetings, exercise the votes attaching to Scheme Shares registered in their names, or sign any shareholders' resolutions, whether in person, by proxy or by corporate representative (other than pursuant to clause 9.4(a));
- (c) must take all other actions in the capacity of a registered holder of Scheme Shares as Newmont Overseas reasonably directs; and
- (d) acknowledges and agrees that in exercising the powers referred to in clause 9.4(a), Newmont Overseas and any director, officer, secretary or agent nominated by Newmont Overseas under clause 9.4(a) may act in the best



HERBERT
SMITH
FREEHILLS

interests of Newmont Overseas as the intended registered holder of the Scheme Shares.

9.5 Authority given to Newcrest

Each Scheme Shareholder, without the need for any further act by the Scheme Shareholder:

- (a) on the Effective Date, irrevocably appoints Newcrest and each of its directors, officers and secretaries (jointly and each of them severally) as its attorney and agent for the purpose of enforcing the Deed Poll against Newmont and Newmont Overseas, and Newcrest undertakes in favour of each Scheme Shareholder that it will enforce the Deed Poll against Newmont and Newmont Overseas on behalf of and as agent and attorney for each Scheme Shareholder; and
- (b) on the Implementation Date, irrevocably appoints Newcrest and each of its directors, officers and secretaries (jointly and each of them severally) as its attorney and agent for the purpose of executing any document or doing or taking any other act necessary, desirable or expedient to give effect to this Scheme and the transactions contemplated by it, including (without limitation):
 - (1) executing the Scheme Transfer; and
 - (2) executing and delivering any deed or document required by Newmont, that causes each Scheme Shareholder to become a shareholder of Newmont or holder of New Newmont CDIs or New Newmont PDIs and to be bound by the certificate of incorporation and by-laws of Newmont,

and Newcrest accepts each such appointment. Newcrest as attorney and agent of each Scheme Shareholder, may sub-delegate its functions, authorities or powers under this clause 9.5 to all or any of its directors, officers, secretaries or employees (jointly, severally or jointly and severally).

9.6 Binding effect of Scheme

This Scheme binds Newcrest and all of the Scheme Shareholders (including those who did not attend the Scheme Meeting to vote on this Scheme, did not vote at the Scheme Meeting, or voted against this Scheme at the Scheme Meeting) and, to the extent of any inconsistency, overrides the constitution of Newcrest.

10 General

10.1 Stamp duty

Newmont or Newmont Overseas:

- (a) must pay all duty, if applicable (including applicable stamp duties and any fines and penalties with respect to any such duty) in respect of this Scheme, the Deed Poll, the performance of the Deed Poll and each transaction effected by or made under or in connection with this Scheme and the Deed Poll; and
- (b) indemnifies each Scheme Shareholder against any liability arising from failure to comply with clause 10.1(a).



HERBERT
SMITH
FREEHILLS

10.2 Consent

Each of the Scheme Shareholders consents to Newcrest doing all things necessary or incidental to, or to give effect to, the implementation of this Scheme and the transactions contemplated by it, whether on behalf of the Scheme Shareholders, Newcrest or otherwise.

10.3 Notices

- (a) If a notice, transfer, transmission application, direction or other communication referred to in this Scheme is sent by post to Newcrest, it will not be taken to be received in the ordinary course of post or on a date and time other than the date and time (if any) on which it is actually received at Newcrest's registered office or at the office of the Newcrest Registry.
- (b) The accidental omission to give notice of the Scheme Meeting or the non-receipt of such notice by a Newcrest Shareholder will not, unless so ordered by the Court, invalidate the Scheme Meeting or the proceedings of the Scheme Meeting.

10.4 Governing law

- (a) This Scheme is governed by the laws in force in Victoria, Australia.
- (b) The parties irrevocably submit to the non-exclusive jurisdiction of courts exercising jurisdiction in Victoria and courts of appeal from them in respect of any proceedings arising out of or in connection with this Scheme. The parties irrevocably waive any objection to the venue of any legal process in these courts on the basis that the process has been brought in an inconvenient forum.

10.5 Further action

Newcrest must do all things and execute all documents (whether on its own behalf or on behalf of each Scheme Shareholder) necessary to give full effect to this Scheme and the transactions contemplated by it.

10.6 No liability when acting in good faith

Each Scheme Shareholder agrees that neither Newcrest, Newmont, Newmont Overseas nor any of their respective directors, officers, secretaries or employees shall be liable for anything done or omitted to be done in the performance of this Scheme or the Deed Poll in good faith.



HERBERT
SMITH
FREEHILLS

Deed

Deed poll

Newmont

Newmont Overseas

80 Collins Street Melbourne Vic 3000 Australia
GPO Box 128A Melbourne Vic 3001 Australia

T +61 3 9288 1234 F +61 3 9288 1567
herbertsmithfreehills.com DX 240 Melbourne



Deed poll

Date ► 4 September 2023

This deed poll is made

By **Newmont Corporation**
of 6900 E.Layton Avenue, Suite 700, Denver, Colorado, 80237,
United States of America (**Newmont**)
and
Newmont Overseas Holdings Pty Ltd
ACN 667 845 454 of Level 5, 500 Hay Street, Subiaco WA 6008
(**Newmont Overseas**)

in favour of each Scheme Shareholder

Recitals

- 1 Newcrest, Newmont and Newmont Overseas entered into the Implementation Deed.
- 2 In the Implementation Deed, Newmont and Newmont Overseas each agreed to make this deed poll.
- 3 Newmont and Newmont Overseas are making this deed poll for the purpose of covenanting in favour of the Scheme Shareholders to perform their obligations under the Scheme.

This deed poll provides as follows:

1 Definitions and interpretation

1.1 Definitions

(a) The meanings of the terms used in this deed poll are set out below.

Term	Meaning
First Court Date	the first day on which an application made to the Court for an order under subsection 411(1) of the Corporations Act convening the Scheme Meeting is heard.



HERBERT
SMITH
FREEHILLS

2 Conditions to obligations

Term	Meaning
Implementation Deed	the scheme implementation deed dated 15 May 2023 between Newcrest, Newmont and Newmont Overseas, as amended from time to time.
Newcrest	Newcrest Mining Limited ACN 005 683 625.
Scheme	the scheme of arrangement under Part 5.1 of the Corporations Act between Newcrest and the Scheme Shareholders, substantially in the form attached to the Implementation Deed, subject to any alterations or conditions made or required by the Court under subsection 411(6) of the Corporations Act, or proposed by a party, and in each case agreed to in writing by Newcrest and Newmont and Newmont Overseas.
(b)	Unless the context otherwise requires, terms defined in the Scheme have the same meaning when used in this deed poll.

1.2 Interpretation

Clauses 1.2, 1.3, 1.4 and 1.5 of the Scheme apply to the interpretation of this deed poll, except that references to 'this Scheme' are to be read as references to 'this deed poll'.

1.3 Nature of deed poll

Each of Newmont and Newmont Overseas acknowledges that:

- (a) this deed poll may be relied on and enforced by any Scheme Shareholder in accordance with its terms even though the Scheme Shareholders are not party to it; and
- (b) under the Scheme, each Scheme Shareholder irrevocably appoints Newcrest and each of its directors, officers and secretaries (jointly and each of them severally) as its agent and attorney to enforce this deed poll against Newmont and Newmont Overseas in accordance with its terms.

2 Conditions to obligations

2.1 Conditions

This deed poll and the obligations of Newmont and Newmont Overseas under this deed poll are subject to the Scheme becoming Effective.

2.2 Termination

The obligations of Newmont and Newmont Overseas under this deed poll will automatically terminate and the terms of this deed poll will be of no force or effect if:

- (a) the Implementation Deed is terminated in accordance with its terms; or



- (b) the Scheme has not become Effective on or before the End Date, unless Newcrest, Newmont and Newmont Overseas otherwise agree in writing.

2.3 Consequences of termination

If this deed poll terminates under clause 2.2, in addition and without prejudice to any other rights, powers or remedies available to it:

- (a) each of Newmont and Newmont Overseas is released from its obligations under this deed poll; and
- (b) each Scheme Shareholder retains the rights they have against Newmont and Newmont Overseas in respect of any breach of this deed poll which occurred before this deed poll was terminated.

3 Scheme obligations

3.1 Undertaking to issue Scheme Consideration

Subject to clause 2, Newmont Overseas undertakes in favour of each Scheme Shareholder to:

- (a) provide, or procure the provision of, the Scheme Consideration to each Scheme Shareholder in accordance with the terms of the Scheme; and
- (b) undertake all other actions, and give each acknowledgement, representation and warranty (if any), attributed to it under the Scheme,

in each case, subject to and in accordance with the terms of the Scheme.

3.2 Newmont's obligations and guarantee

- (a) Subject to clause 2, Newmont undertakes in favour of each Scheme Shareholder to undertake all actions, and give each acknowledgement, representation and warranty (if any), attributed to it under the Scheme subject to and in accordance with the terms of the Scheme.
- (b) Subject to clause 2, Newmont undertakes in favour of each Scheme Shareholder to:
 - (1) procure that Newmont Overseas undertakes all actions, and gives each acknowledgment, representation and warranty (if any), attributed to Newmont Overseas under the Scheme and this deed poll; and
 - (2) guarantee the due and punctual performance of Newmont Overseas of all of Newmont Overseas' obligations and actions attributed to Newmont Overseas under the Scheme and this deed poll.

3.3 Shares to rank equally

Newmont covenants in favour of each Scheme Shareholder that the New Newmont Shares which are issued (including those issued to CDN in connection with the New Newmont CDIs and to PDN in connection with the New Newmont PDIs) to each Scheme Shareholder in accordance with the Scheme will:

- (a) rank equally with all other Newmont Shares on issue as set out in clause 5.8(a) of the Scheme; and



- (b) be issued fully paid and free from any Security Interest or encumbrance.

4 Warranties

Each of Newmont and Newmont Overseas represents and warrants in favour of each Scheme Shareholder, in respect of itself, that:

- (a) it is a corporation validly existing under the laws of its place of registration;
- (b) it has the corporate power to enter into and perform its obligations under this deed poll and to carry out the transactions contemplated by this deed poll;
- (c) it has taken all necessary corporate action to authorise its entry into this deed poll and has taken or will take all necessary corporate action to authorise the performance of this deed poll and to carry out the transactions contemplated by this deed poll;
- (d) this deed poll is valid and binding on it and enforceable against it in accordance with its terms; and
- (e) this deed poll does not conflict with, or result in the breach of or default under, any provision of its constitution, or any writ, order or injunction, judgment, law, rule or regulation to which it is a party or subject or by which it is bound.

5 Continuing obligations

This deed poll is irrevocable and, subject to clause 2, remains in full force and effect until the earlier of:

- (a) each of Newmont and Newmont Overseas has fully performed its obligations under this deed poll; or
- (b) the earlier termination of this deed poll under clause 2.2.

6 Notices

6.1 Form of Notice

A notice or other communication in respect of this deed poll (**Notice**) must be:

- (a) in writing and in English and signed for or on behalf of the sending party; and
- (b) addressed to Newmont and Newmont Overseas in accordance with the details set out below (or any alternative details nominated by Newmont or Newmont Overseas by Notice).

Attention Mark Ebel

Address 6900 E.Layton Avenue, Suite 700, Denver, Colorado,
80237, United States of America



Email address legalnotices@newmont.com

With copy to (which shall not constitute notice): will.heath@au.kwm.com
antonella.pacitti@au.kwm.com

If a person sends a communication contemplated by this deed poll other than by email, they must use all reasonable endeavours to send a copy of the communication promptly by email.

6.2 How Notice must be given and when Notice is received

- (a) A Notice must be given by one of the methods set out in the table below.
- (b) A Notice is regarded as given and received at the time set out in the table below.

However, if this means the Notice would be regarded as given and received outside the period between 9.00am and 5.00pm (addressee's time) on a Business Day (**business hours period**), then the Notice will instead be regarded as given and received at the start of the following business hours period.

Method of giving Notice	When Notice is regarded as given and received
By hand to the nominated address	When delivered to the nominated address.
By email to the nominated email address	When the party sending the email receives notification that the email was successfully transmitted and read by the receiving party, or if no such notification is received, four hours after the email was sent, unless the party sending the email receives notification that the email was not successfully transmitted.

6.3 Notice must not be given by electronic communication

A Notice must not be given by electronic means of communication (other than email as permitted in clause 6.2).

7 General

7.1 Stamp duty

Newmont or Newmont Overseas:

- (a) must pay all duty, if applicable (including applicable stamp duties and any fines and penalties with respect to any such duty) in respect of the Scheme, this deed poll, the performance of this deed poll and each transaction effected by or made under or in connection with the Scheme and this deed poll; and



- (b) indemnifies each Scheme Shareholder against any liability arising from failure to comply with clause 7.1(a).

7.2 Governing law and jurisdiction

- (a) This deed poll is governed by the law in force in Victoria, Australia.
- (b) Each of Newmont and Newmont Overseas irrevocably submits to the non-exclusive jurisdiction of courts exercising jurisdiction in Victoria, Australia and courts of appeal from them in respect of any proceedings arising out of or in connection with this deed poll.
- (c) Each of Newmont and Newmont Overseas irrevocably waives any objection to the venue of any legal process in these courts on the basis that the process has been brought in an inconvenient forum.
- (d) Each of Newmont and Newmont Overseas agrees that a final judgment in any legal proceedings in a court exercising jurisdiction in Victoria, Australia will be conclusive and may be enforced in other jurisdictions by suit on the judgement or in any other manner provided by applicable law.

7.3 Waiver

- (a) Each of Newmont and Newmont Overseas may not rely on the words or conduct of any Scheme Shareholder as a waiver of any right unless the waiver is in writing and signed by the Scheme Shareholder granting the waiver.
- (b) No Scheme Shareholder may rely on words or conduct of Newmont or Newmont Overseas as a waiver of any right unless the waiver is in writing and signed by Newmont.
- (c) The meanings of the terms used in this clause 7.3 are set out below.

Term	Meaning
Conduct	includes delay in the exercise of a right.
Right	any right arising under or in connection with this deed poll and includes the right to rely on this clause.
Waiver	includes an election between rights and remedies, and conduct which might otherwise give rise to an estoppel.

7.4 Variation

A provision of this deed poll may not be varied by Newmont or Newmont Overseas unless:

- (a) if before the First Court Date, the variation is agreed to by Newcrest; or
- (b) if on or after the First Court Date, the variation is agreed to by Newcrest and the Court indicates that the variation would not of itself preclude approval of the Scheme,



in which event Newmont and Newmont Overseas will enter into a further deed poll in favour of the Scheme Shareholders giving effect to the variation.

7.5 Partial exercising of rights

Unless this deed poll expressly states otherwise, if Newmont or Newmont Overseas does not exercise a right, power or remedy in connection with this deed poll fully or at a given time, it may still exercise it later.

7.6 Cumulative rights

The rights, powers and remedies of Newmont, Newmont and the Scheme Shareholders under this deed poll are cumulative and do not exclude any other rights, powers or remedies provided by law independently of this deed poll.

7.7 Assignment

- (a) The rights created by this deed poll are personal to Newmont, Newmont Overseas and each Scheme Shareholder and must not be dealt with at law or in equity without the prior written consent of Newmont and Newmont Overseas.
- (b) Any purported dealing in contravention of clause 7.7(a) is invalid.

7.8 Further action

Each of Newmont and Newmont Overseas must, at its own expense, do all things and execute all documents necessary to give full effect to this deed poll.

7.9 Service of process

- (a) Without preventing any method of service, Newmont and Newmont Overseas irrevocably appoints King & Wood Mallesons as its agent for the service of process agent in Australia in relation to any matter arising out of this deed poll, and agrees that any document may be served on Newmont and Newmont Overseas by being delivered to or left for Newmont and Newmont Overseas at the following address:

King & Wood Mallesons
Level 61, Governor Phillip Tower
1 Farrer Place
SYDNEY, NSW 2000
- (b) If King & Wood Mallesons ceases to be able to act as process agent, Newmont and Newmont Overseas undertakes to appoint a new process agent in the jurisdiction referred to in clause 7.2 and deliver to Newcrest within 2 Business Days a copy of a written acceptance of appointment by the process agent, upon receipt of which the new appointment becomes effective for the purpose of this deed. Newmont must inform Newcrest in writing of any change in the address of its process agent within 2 Business Days of the change.
- (c) Each of Newmont and Newmont Overseas agrees that failure by its process agent to notify Newmont of any document in connection with this deed poll does not invalidate the document concerned.
- (d) Each of Newmont and Newmont Overseas agrees that service of documents on its process agent is sufficient service on it.



HERBERT
SMITH
FREEHILLS

Signing page

Executed as a deed poll

Newmont

Signed sealed and delivered by
Newmont Corporation
in the presence of



sign here → *Logan Hennessey* sign here → *Kristen Wagner*
Authorised signatory Witness

print name Logan Hennessey print name Kristen Wagner

Annexure 4. Deed Poll



DocuSign Envelope ID: 73AA2AE5-E9B7-4904-8E63-4106AB5689AF



Signing page

Newmont Overseas

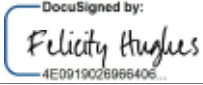
Signed sealed and delivered by
**Newmont Overseas Holdings
Pty Ltd** in accordance with section
127 of the Corporations Act
By

<p>sign here ▶  4E0919026986406...</p>	<p>sign here ▶  BB1EDC5D6CF3425...</p>
Company Secretary/Director	Director
print name _____ Felicity Hughes	print name _____ Mia Gous



Notice of Scheme Meeting

Newcrest Mining Limited ACN 005 683 625

Notice of meeting

Newcrest Mining Limited ACN 005 683 625 (**Newcrest**) gives notice that, by order of the Federal Court of Australia (**Court**) pursuant to section 411(1) of the Corporations Act, a meeting of holders of fully paid ordinary shares in Newcrest (**Scheme Meeting**) will be held on Friday, 13 October 2023 at 10.30am (Melbourne time).

The Scheme Meeting will be held at RACV City Club, 501 Bourke Street, Melbourne, Victoria 3000 and online at <https://meetings.linkgroup.com/NCMSHEME>.

Business of the Scheme Meeting

The purpose of the Scheme Meeting is to consider and, if thought fit, agree to a scheme of arrangement proposed to be entered into between Newcrest and Newcrest Shareholders (with or without modification or conditions).

A copy of the Scheme and a copy of the explanatory statement required by section 412 of the Corporations Act in relation to the Scheme are contained in the Scheme Booklet, of which this notice forms part.

Scheme Resolution

To consider and, if thought fit, to agree (with or without modification or conditions) to the following resolution (**Scheme Resolution**):

"That, pursuant to and in accordance with section 411 of the Corporations Act 2001 (Cth), the scheme of arrangement proposed between Newcrest Mining Limited and the holders of its fully paid ordinary shares as contained in and more precisely described in the Scheme Booklet of which the notice convening this meeting forms part, is agreed to (with or without modification as approved by the Federal Court of Australia to which Newcrest and Newmont agree)."

Chair

The Court has directed that Peter Tomsett is to act as chair of the Scheme Meeting (and that, if he is unable or unwilling to attend, Vickki McFadden is to act as chair of the Scheme Meeting).

By order of the Court and the Board of Newcrest Mining Limited.

Maria Sanz Perez
Company Secretary

Newcrest Mining Limited

Annexure 5. Notice of Scheme Meeting

Explanatory notes

1. General

This notice of meeting and the Scheme Resolution should be read in conjunction with the Scheme Booklet of which this notice forms part. The Scheme Booklet provides the important information you need to help you decide on how to vote on the Scheme Resolution.

Unless otherwise defined, terms used in this notice have the same meaning as set out in the Definitions in section 12 of the Scheme Booklet.

2. Required majorities at the Scheme Meeting

In accordance with section 411(4)(a) of the Corporations Act, for the Scheme to be approved by Newcrest Shareholders, the Scheme Resolution must be passed by:

- a majority in number (more than 50%) of Newcrest Shareholders present and voting at the Scheme Meeting (either in person or by proxy, attorney or, in the case of corporate Newcrest Shareholders, body corporate representative); and
- at least 75% of the total number of votes cast on the Scheme Resolution at the Scheme Meeting by Newcrest Shareholders present and voting (either in person or by proxy, attorney or, in the case of corporate Newcrest Shareholders, body corporate representative).

The Court has the power to waive the first requirement.

3. Court approval

In accordance with section 411(4)(b) of the Corporations Act, the Scheme must be approved by an order of the Court. If the Scheme Resolution set out in this notice is agreed to by the required majorities set out above and the conditions set out in the Scheme Implementation Deed are satisfied or waived (where capable of waiver), Newcrest will apply to the Court for the necessary orders to approve the Scheme.

4. Entitlement to participate in and vote at the Scheme Meeting

For the purpose of voting at the Scheme Meeting, Newcrest Shareholders will be entitled to participate in and vote at the Scheme Meeting if they are a registered holder of Newcrest Shares on the Newcrest Share Register as at 7.00pm (Melbourne time) on Wednesday, 11 October 2023. Registration will be open from 10.00am (Melbourne Time) on Wednesday, 11 October 2023.

Newcrest Shareholders (or their proxies, attorneys or authorised corporate representatives) will be able to participate in the Scheme Meeting by attending in person at RACV City Club, 501 Bourke Street, Melbourne, Victoria 3000 or online at <https://meetings.linkgroup.com/NCMScheme>. Participating Newcrest Shareholders will be able to view the proceedings, vote and ask questions or make comments in real time.

Information as to how Newcrest Shareholders may attend the Scheme Meeting is provided in this notice and set out in the Scheme Meeting Online Guide which is available at www.newcrest.com/investor-centre/schememeeting.

5. How to vote

Newcrest Shareholders entitled to vote at the Scheme Meeting may do so in a number of ways as set out in this section 5.

If Newcrest Shares are jointly held, each of the joint Newcrest Shareholders is entitled to vote. However, if more than one Newcrest Shareholder votes in respect of jointly held Newcrest Shares, only the vote of the shareholder whose name appears first on the Newcrest Share Register will be counted.

Voting at the Scheme Meeting will be conducted by poll.

a) Voting and proxy appointment by Newcrest Shareholders on the Australian and PNG registers

Newcrest Shareholders entitled to vote at the Scheme Meeting may vote:

- **in person**, by physically attending the Scheme Meeting held at RACV City Club, 501 Bourke Street, Melbourne, Victoria 3000;
- **online**, by participating and voting online at the Scheme Meeting at <https://meetings.linkgroup.com/NCMScheme>. To vote online, Newcrest Shareholders will need their SRN/HIN and their postcode or country of residence (if outside Australia);
- **by proxy**, by lodging a Proxy and Voting Form in one of the following ways:
 - > **online** at <https://investorcentre.linkgroup.com> or on their smartphone using the QR code on the Proxy and Voting Form. To do so Newcrest Shareholders will need their SRN or HIN and the postcode for their shareholding;
 - > **by post** in the reply-paid envelope provided to Newcrest Mining Limited C/- Link Market Services Limited, Locked Bag A14 Sydney South NSW 1235 Australia;
 - > **by hand delivery** during business hours to the Newcrest Share Registry at Link Market Services Limited, at either Parramatta Square, Level 22, Tower 6, 10 Darcy Street, Parramatta NSW 2150 or Level 12, 680 George Street, Sydney NSW 2000; or
 - > **by fax** to the Newcrest Share Registry +61 2 9287 0309.



Explanatory notes

5. How to vote *continued*

Proxyholders will be emailed their proxy code by the Newcrest Share Registry 24 hours before the commencement of the Scheme Meeting. Newcrest Shareholders on the PNG register should refer to the Proxy and Voting Form for PNG specific contact information for lodgement by post, hand delivery, fax or email;

- **by casting a direct vote**, prior to the Scheme Meeting either online at <https://investorcentre.linkgroup.com> or by submitting a Proxy and Voting Form in the manner stated on the form and described above;
- **by attorney**, by appointing an attorney to attend and vote at the Scheme Meeting on your behalf. An attorney may, but need not, be a Newcrest Shareholder. An attorney may not vote at the Scheme Meeting unless the instrument appointing the attorney, and the authority under which the instrument is signed or a certified copy of the authority, are received by Newcrest before the Scheme Meeting (unless it has been previously given to Newcrest). A validly appointed attorney wishing to attend and vote at the Scheme Meeting via the online platform will require the appointing Newcrest Shareholder's name and postcode and the SNR/HIN of the shareholding in order to access the online platform; or
- **by corporate representative**, if you are a body corporate, by appointing a corporate representative to attend and vote at the Scheme Meeting on behalf of that Newcrest Shareholder. The corporate representative must ensure that Newcrest has received a certificate of appointment, together with any authority under which the appointment is signed, prior to the Scheme Meeting (unless it has previously been given to Newcrest). A form of notice of appointment can be obtained from Link Market Services by calling 1300 554 474 within Australia or +61 1300 554 474 outside Australia (between 8.30am and 7.30pm (Melbourne Time)) or downloaded from www.linkmarketservices.com.au. A validly appointed corporate representative wishing to attend and vote at the Scheme Meeting via the online platform will require the appointing Newcrest Shareholder's name, the SRN/HIN of the shareholding, proxy code and postcode or country of residence (if outside Australia) in order to access the online platform.

Proxy appointments and direct votes must be received by 10.30am (Melbourne time) on Wednesday, 11 October 2023 (for those holding Newcrest Shares on the Canadian register, your equivalent Eastern Time deadline is 7.30pm on Tuesday, 10 October 2023).

b) Voting and proxy appointment by Newcrest Shareholders on the Canadian registers

Registered holders on the Canadian register

You are a registered shareholder if your name appears on your share certificate. If your Newcrest Shares are held on the Canadian register, your Notice of Access letter was accompanied by a Proxy and Voting Form. Newcrest Shareholders who are registered shareholders on the Canadian share register can vote:

- **in person**, by physically attending the Scheme Meeting held at RACV City Club, 501 Bourke Street, Melbourne, Victoria 3000;
- **online** at www.meeting-vote.com by following the on-screen instructions or on their smartphone using the QR code on the Proxy and Voting Form;
- **by proxy**, by lodging a Proxy and Voting Form in one of the following ways:
 - > by scanning and emailing the form to proxyvote@tmx.com;
 - or
 - > by mailing the form to TSX Trust Company, Attention: Proxy Department, P.O. Box 721, Agincourt, ON M1S 0A1.

TSX Trust Company must receive your voting instructions by 7.30pm (Eastern Time) on Tuesday, 10 October 2023.

Non-registered holders on the Canadian register

You are a non-registered shareholder if your Newcrest Shares are registered under the name of an intermediary or other financial institution, or held in the name of a clearing agency (such as CDS or Depository Trust Company) that their intermediary deals with, and you are the beneficial owner.

If you are the beneficial owner of the Newcrest Shares, you have the right to instruct your intermediary how to vote your Newcrest Shares. Your Notice of Access letter includes a Voting Instruction Form. To instruct your intermediary how to cast your votes, please follow the instructions on the Voting Instruction Form.

Annexure 5. Notice of Scheme Meeting

Explanatory notes

6. Proxy voting

A Newcrest Shareholder who is entitled to cast two or more votes may appoint not more than two proxies. A proxy need not be a Newcrest Shareholder. A proxy may be either an individual or a body corporate.

Where two proxies are appointed, each proxy may be appointed to represent a specified proportion or number of the voting rights of the Newcrest Shareholder. If no proportion or number is specified, each proxy may exercise half the votes. If a Newcrest Shareholder wishes to appoint two proxies, an additional Proxy and Voting Form can be downloaded at www.newcrest.com/investor-centre/schememeeting.

If the chair of the Scheme Meeting is a proxy, either by appointment or default, and the appointment does not provide any voting directions on the Proxy and Voting Form, by signing and returning the Proxy and Voting Form, the Newcrest Shareholder will be expressly authorising the chair of the Scheme Meeting to cast their vote on the Scheme Resolution as the chair of the Scheme Meeting sees fit.

The chair of the Scheme Meeting intends to vote undirected proxies in favour of the Scheme Resolution.

7. How to ask questions

a) Questions prior to the Scheme Meeting

Newcrest Shareholders can submit questions in advance of the Scheme Meeting. This can be done by the following methods:

- online at <https://investorcentre.linkgroup.com>; or
- by downloading the online shareholder question form available at www.newcrest.com/investor-centre/schememeeting and returning it by email to corporateaffairs@newcrest.com.au.

All questions must be received by no later than 10.30am (Melbourne Time) on Wednesday, 11 October 2023.

b) Questions during the Scheme Meeting

Newcrest Shareholders will have a reasonable opportunity to ask questions or make comments about the Scheme at the Scheme Meeting in person, whether they attend in person or participate via the online platform.

If Newcrest Shareholders participate in the Scheme Meeting via the online platform, Newcrest Shareholders may ask written questions or verbal questions during the Scheme Meeting. To ask a question verbally by phone, Newcrest Shareholders can call 1800 497 114 (within Australia) or +61 2 9189 1123 (outside Australia) and use their unique personal identification number (**PIN**). Newcrest Shareholders may obtain a PIN by contacting Link on 1800 990 363 (within Australia) or +61 1800 990 363 (outside Australia) by 4.00pm (Melbourne time) on Wednesday, 11 October 2023. For further information, please refer to the Scheme Meeting Online Guide which is available on Newcrest's website at www.newcrest.com/investor-centre/schememeeting.

The chair will endeavour to address as many of the more frequently raised relevant questions as possible during the course of the meeting. However, there may not be sufficient time available at the meeting to address all of the questions raised. Individual responses will not be sent to Newcrest Shareholders.

8. Technical difficulties

Technical difficulties may arise during the Scheme Meeting. The chair of the Scheme Meeting has discretion as to whether and how the Scheme Meeting should proceed if a technical difficulty arises. In exercising their discretion, the chair will have regard to the number of Newcrest Shareholders impacted and the extent to which participation in the business of the Scheme Meeting is affected.

Where considered appropriate, the chair of the Scheme Meeting may continue to hold the Scheme Meeting and transact business, including conducting a poll and voting in accordance with valid proxy instructions. For this reason, if Newcrest Shareholders have already decided how they will cast their vote on the Scheme Resolution, they are encouraged to lodge a direct vote or directed proxy by 10.30am (Melbourne Time) on Wednesday, 11 October 2023 (equivalent to 7.30pm (Eastern Time) on Tuesday, 10 October 2023, in the case of Newcrest Shareholders that hold Newcrest Shares on the Canadian register) even if they plan to attend the Scheme Meeting in person or online.

In the event of a technological failure that prevents Newcrest Shareholders from having a reasonable opportunity to participate in the Scheme Meeting, Newcrest will provide an update on its website and the ASX, PNGX and TSX to communicate the details of any postponement or adjournment of the Scheme Meeting to Newcrest Shareholders.

9. Listings

The Company is listed on the ASX, TSX and PNGX. It is a "designated foreign issuer" as defined in the Canadian National Instrument 71-102 - Continuous Disclosure and Other Exemptions Relating to Foreign Issuers and is subject to the regulatory requirements of the Australian Securities & Investments Commission and the Australian Securities Exchange.



Newcrest Mining Limited

Level 8, 600 St Kilda Road
Melbourne VIC 3004

Financial advisers

J.P. Morgan Securities Australia Limited

Level 18, J.P. Morgan House,
85 Castlereagh Street
Sydney NSW 2000

Gresham Advisory Partners Limited

Level 25, Aurora Place,
88 Phillip Street, Sydney NSW 2000

Legal adviser

Herbert Smith Freehills

Level 24, 80 Collins Street
Melbourne VIC 3000

Independent Expert

Grant Samuel & Associates Pty Limited

Level 19, Governor Macquarie Tower,
1 Farrer Place, Sydney NSW 2000

Investigating Accountant

Ernst & Young Strategy and Transactions Limited

Level 23, 8 Exhibition Street
Melbourne VIC 3000

Newcrest Share Registry

Australia

Link Market Services

Tower 4, 727 Collins Street
Docklands VIC 3008

Canada

TSX Trust Company

PO Box 700, Station B
Montreal, QC H3B 3K3

Papua New Guinea

PNG Registries Limited

Level 4, Cuthbertson House
Cuthbertson Street, Port Moresby, NCD
Papua New Guinea

ADSs

BNY Mellon Shareowner Services

PO Box 505000
Louisville, KY 40233-5000, USA



NEWCREST
MINING LIMITED

LODGE YOUR DIRECTION

 **ONLINE**
<https://investorcentre.linkgroup.com>

 **BY MAIL**
Newcrest Mining Limited
C/- Link Market Services Limited
Locked Bag A14
Sydney South NSW 1235 Australia

 **BY FAX**
+61 2 9287 0309

 **BY HAND**
Link Market Services Limited
Parramatta Square, Level 22, Tower 6,
10 Darcy Street, Parramatta NSW 2150; or
Level 12, 680 George Street, Sydney NSW 2000

 **ALL ENQUIRIES TO**
Telephone: +61 1300 554 474

PROXY AND VOTING FORM

I/We being a shareholder(s) of Newcrest Mining Limited and entitled to attend and vote at the Scheme Meeting hereby:

STEP 1 Please mark either A or B

A VOTE DIRECTLY
 elect to lodge my/our
vote(s) directly (mark box)

 in relation to the Scheme Meeting of the Company to be held at **10:30am (Melbourne time) on Friday, 13 October 2023**, and at any adjournment or postponement of the Meeting.

You should mark either "for" or "against" for the item. Do not mark the "abstain" box.

OR B APPOINT A PROXY

the Chair of the Meeting (mark box) **OR** if you are **NOT** appointing the Chair of the Meeting as your proxy, please write the name and email of the person or body corporate you are appointing as your proxy

Name

Email

or failing the person or body corporate named, or if no person or body corporate is named, the Chair of the Meeting, as my/our proxy to act on my/our behalf (including to vote in accordance with the following directions or, if no directions have been given and to the extent permitted by the law, as the proxy sees fit) at the Scheme Meeting of the Company to be held at **10:30am (Melbourne time) on Friday, 13 October 2023 (the Meeting)** and at any postponement or adjournment of the Meeting.

The Meeting will be conducted as a hybrid event and you can participate by attending at **RACV City Club, 501 Bourke Street, Melbourne** or by logging in via the online platform at **<https://meetings.linkgroup.com/NCMScheme>** (refer to details in the Online Guide which will be published on the Company's website at www.newcrest.com).

The Chair of the Meeting intends to vote undirected proxies in favour of the item of business.

VOTING DIRECTIONS

Proxies will only be valid and accepted by the Company if they are signed and received no later than 48 hours before the Meeting.

Please read the voting instructions overleaf before marking any box with an

Resolution

- 1** That, pursuant to and in accordance with section 411 of the Corporations Act 2001 (Cth), the scheme of arrangement proposed between Newcrest Mining Limited and the holders of its fully paid ordinary shares as contained in and more precisely described in the Scheme Booklet of which the notice convening this meeting forms part, is agreed to (with or without modification as approved by the Federal Court of Australia to which Newcrest and Newmont agree).

For Against Abstain*



* If you mark the Abstain box for the Item, you are directing your proxy not to vote on your behalf on a poll and your votes will not be counted in computing the required majority on a poll.

STEP 2

SIGNATURE OF SHAREHOLDERS – THIS MUST BE COMPLETED

Shareholder 1 (Individual)

Joint Shareholder 2 (Individual)

Joint Shareholder 3 (Individual)

Sole Director and Sole Company Secretary

Director/Company Secretary (Delete one)

Director

This form should be signed by the shareholder. If a joint holding, either shareholder may sign. If signed by the shareholder's attorney, the power of attorney must have been previously noted by the registry or a certified copy attached to this form. If executed by a company, the form must be executed in accordance with the company's constitution and the *Corporations Act 2001* (Cth).

STEP 3

NCM PRX2301N



HOW TO COMPLETE THIS FORM

YOUR NAME AND ADDRESS

This is your name and address as it appears on the Company's Share register. If this information is incorrect, please make the correction on the form. Shareholders sponsored by a broker should advise their broker of any changes. **Please note: you cannot change ownership of your Shares using this form.**

VOTING UNDER BOX A

If you ticked the box under Box A you are indicating that you wish to vote directly. Please only mark either "for" or "against" for the item. Do not mark the "abstain" box. If you mark the "abstain" box for the item, your vote will be invalid.

If no direction is given on the item, or if you complete both Box A and Box B, your vote may be passed to the Chair of the Meeting as your proxy.

Custodians and nominees may, with the Share Registrar's consent, identify on the Proxy and Voting Form the total number of votes in each of the categories "for" and "against" and their votes will be valid.

If you have lodged a direct vote, and then you attend the Meeting, your attendance will cancel your direct vote.

The Chair's decision as to whether a direct vote is valid is conclusive.

VOTING UNDER BOX B – APPOINTMENT OF PROXY

If you wish to appoint the Chair of the Meeting as your proxy, mark the box in Step 1. If you wish to appoint someone other than the Chair of the Meeting as your proxy, please write the name and email address of that individual or body corporate in Step 1. A proxy need not be a Shareholder of the Company.

DEFAULT TO CHAIR OF THE MEETING

Any directed proxies that are not voted on a poll at the Meeting will default to the Chair of the Meeting, who is required to vote those proxies as directed. Any undirected proxies that default to the Chair of the Meeting will be voted according to the instructions set out in this Proxy and Voting Form.

VOTES ON THE ITEM OF BUSINESS – PROXY APPOINTMENT

You may direct your proxy how to vote by placing a mark in one of the boxes opposite the item of business. All your Shares will be voted in accordance with such a direction unless you indicate only a portion of voting rights are to be voted on the item by inserting the percentage or number of Shares you wish to vote in the appropriate box or boxes. If you do not mark any of the boxes on the item of business, your proxy may vote as he or she chooses. If you mark more than one box on the item without specifying the portion of your voting right to be voted on each, your vote will be invalid.

APPOINTMENT OF A SECOND PROXY

You are entitled to appoint up to two persons as proxies to attend the Meeting and vote on a poll. If you wish to appoint a second proxy, an additional Proxy and Voting Form may be obtained by telephoning the Company's Share registry or you may copy this form and return them both together.

To appoint a second proxy you must:

- on each of the first Proxy and Voting Form and the second Proxy and Voting Form state the percentage of your voting rights or number of Shares applicable to that form. If the appointments do not specify the percentage or number of votes that each proxy may exercise, each proxy may exercise half your votes. Fractions of votes will be disregarded; and
- return both forms together.

SIGNING INSTRUCTIONS

You must sign this form as follows in the spaces provided:

Individual: where the holding is in one name, the holder must sign.

Joint Holding: where the holding is in more than one name, either Shareholder may sign.

Power of Attorney: to sign under Power of Attorney, you must lodge the Power of Attorney with the registry. If you have not previously lodged this document for notation, please attach a certified photocopy of the Power of Attorney to this form when you return it.

Companies: where the company has a Sole Director who is also the Sole Company Secretary, this form must be signed by that person. If the company (pursuant to section 204A of the *Corporations Act 2001*) does not have a Company Secretary, a Sole Director can also sign alone. Otherwise this form must be signed by a Director jointly with either another Director or a Company Secretary. Please indicate the office held by signing in the appropriate place.

CORPORATE REPRESENTATIVES

If a representative of the corporation is to attend the Meeting the appropriate "Certificate of Appointment of Corporate Representative" must be received at vote@linkmarketservices.com.au prior to admission in accordance with the Notice of Scheme Meeting. A form of the certificate may be obtained from the Company's Share registry or online at www.linkmarketservices.com.au.

LODGEMENT OF A PROXY AND VOTING FORM

This Proxy and Voting Form (and any Power of Attorney under which it is signed) must be received at an address given below by **10:30am (Melbourne time) on Wednesday, 11 October 2023**, being not later than 48 hours before the commencement of the Meeting. Any Proxy and Voting Form received after that time will not be valid for the scheduled Meeting.

Proxy and Voting Forms may be lodged using the reply paid envelope or:



ONLINE

<https://investorcentre.linkgroup.com>

Login to the Link website using the holding details as shown on the Proxy and Voting Form. Select 'Voting' and follow the prompts to lodge your vote. To use the online lodgement facility, shareholders will need their "Holder Identifier" - Securityholder Reference Number (SRN) or Holder Identification Number (HIN).



BY MOBILE DEVICE

Our voting website is designed specifically for voting online. You can now lodge your vote by scanning the QR code adjacent or enter the voting link <https://investorcentre.linkgroup.com> into your mobile device. Log in using the Holder Identifier and postcode for your shareholding.

QR Code



To scan the code you will need a QR code reader application which can be downloaded for free on your mobile device.



BY MAIL

Newcrest Mining Limited
C/- Link Market Services Limited
Locked Bag A14
Sydney South NSW 1235
Australia



BY FAX

+61 2 9287 0309



BY HAND

Delivering it to Link Market Services Limited*
Parramatta Square
Level 22, Tower 6
10 Darcy Street
Parramatta NSW 2150

or

Level 12
680 George Street
Sydney NSW 2000

* During business hours (Monday to Friday, 9:00am–5:00pm)



COMMUNICATIONS PREFERENCE

We encourage you to receive all your shareholder communication via email. This communication method allows us to keep you informed without delay, is environmentally friendly and reduces print and mail costs.



ONLINE

<https://investorcentre.linkgroup.com>

Login to the Link website using the holding details as shown on the Proxy and Voting Form. Select 'Communications' and click the first button to receive all communications electronically and enter your email address. To use the online facility, shareholders will need their 'Holder Identifier' (Shareholder Reference Number (SRN) or Holder Identification Number (HIN) as shown on the front of the Proxy and Voting Form).